

Registration  
Begins  
**May 9**

Classes  
Begin  
**June 21**

School of  
Continuing Ed.  
Pg. **83**





# Take the AQ!

## ASSESSMENT QUESTIONNAIRE



Grab your high school transcript\* and take this **online questionnaire** to get placed in **ENGLISH** and **MATH** courses

*\* Recommended, but not required.*

## Board of TRUSTEES

Dr. Manuel Baca  
Rosanne M. Bader  
Jay Chen  
Judy Chen Haggerty, Esq.  
Dr. David K. Hall  
Robert F. Hidalgo  
Laura Santos  
Corey Case, Student Trustee

Dr. William T. Scroggins  
College President & CEO

## Our MISSION

The mission of Mt. San Antonio College is to support all students in achieving their educational goals in an environment of academic excellence. Specifically, the College is committed to providing quality education, services, and workforce training so that students become productive members of a diverse, sustainable, global society. The College pledges to prepare students for lifelong learning through the mastery of basic skills, the achievement of associate degrees and certificates, and the completion of career and transfer pathways. The College will carry out this commitment by providing an engaging and supportive teaching and learning environment for students of diverse origins, experiences, needs, abilities, and goals. The College is dedicated to serving our community through improving economic achievement, advancing civic engagement, enhancing personal well-being, promoting critical thinking, and enriching aesthetic and cultural experiences.

# Stay *connected* with Mt. SAC through **Social Media**

search: mtsac



Joe Mountie

Go to **www.mtsac.edu**  
and scroll to the bottom of  
the page to download the  
**mountie app**

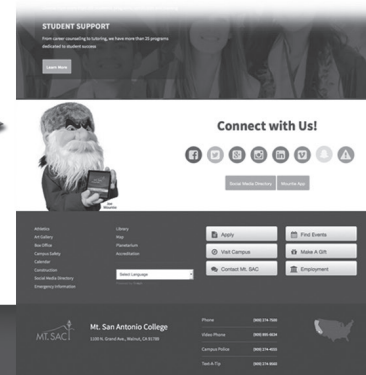

## HOW TO REGISTER . . .

for Credit classes, pages 6-7

School of Continuing Education,  
pages 85-86

**FINANCIAL AID** page 9

**CREDIT CLASSES** page 31

**SCHOOL OF CONTINUING  
EDUCATION CLASSES** page 83



## KEY DATES FOR SUMMER 2018

<b>May 1</b>	International student admission application due for 2018 Fall Semester
<b>May 9</b>	Registration begins for 2018 Summer credit and Continuing Education classes
<b>June 20</b>	Residency determination date
<b>June 21</b>	<b>2018 Summer Intersession begins</b>
<b>June 28</b>	Last day to change residency for 2018 Summer
<b>July 2</b>	Last day to return parking permit for refund
<b>July 4</b>	Independence Day Holiday (campus closed)
<b>July 11</b>	Registration begins for 2018 Fall credit and Continuing Education classes
<b>August 1</b>	<b>2018 Summer Intersession ends</b>
<b>August 27</b>	<b>2018 Fall Semester begins</b>

*The last day for withdrawal or for a refund is specific to the course and is listed on the Student Schedule/Receipt.*

## SUMMER INTERSESSION FINAL EXAMS

Final Exams will be conducted during the last class meeting.

## ALTERNATE FORMATS

The Schedule of Classes is available online at [www.mtsac.edu](http://www.mtsac.edu) and in alternate formats (Braille, enlarged text, e-text, etc.) upon request. Please contact **Accessibility Resource Centers for Students (formerly known as DSPS)** at (909) 274-4290.

## DROP-FOR-NONPAYMENT POLICY

Students are reminded that **payment for all fees is due upon registration**. Students who fail to pay for their classes by the established deadlines **will be dropped**. The deadlines for paying of fees are **Friday, June 15, 2018** (for classes registered May 9, 2018 through June 15, 2018 at 8 p.m.). The deadline will be posted on the student portal at [inside.mtsac.edu](http://inside.mtsac.edu) and on the student Schedule/Receipt. Fee payment can be made either online any time (except from 11 p.m. to 1 a.m.) or in person at the Bursar's Office (Building 4) during regular business hours.

# Contents

ADD Authorization Codes .....	20	Financial Aid & Scholarships .....	9
Attendance, Drop & Withdrawal Policies .....	20	Grades .....	22
Calendar & Deadlines .....	4	How To Add Yourself to a Wait List.....	12-13
Accessibility Resource Centers for Students (formerly known as DSPS) Information ....	8-9	Key Dates.....	4
Campus Directory .....	5	Online Registration.....	10-11
Campus Map .....	102-103	Parking	
Campus Safety .....	29-30	Fees.....	7
Changing Your Class Schedule .....	20	Policies.....	8-9
Childcare Services .....	25	Purchasing a Parking Permit.....	8
Course Policies.....	21	Placement Test Information.....	19-20
Credit Classes.....	31	Police & Campus Safety Escort Service.....	29
Fees		Prerequisites, Corequisites & Advisories.....	18
Fee Payment Options/Policies .....	7	Registration Process.....	6-7
Fee Refund Policy .....	23	School of Continuing Education.....	82
List of Fees .....	7	Student Services & Resources.....	24-28
Nonresidents.....	8	TouchNet: Authorized Users .....	16-17
Paying Fees Online .....	14-15		

## Campus Directory

**For assistance, call the Mt. SAC general number at (909) 274-7500.  
For direct access to offices, dial (909) 274 + the 4-digit extension.**

Accessibility Resource Centers for Students (formerly known as DSPS).....	ext. 4290	High School Outreach.....	ext. 5906
Admissions & Records .....	ext. 4415	Instruction Office .....	ext. 4200
Adult Basic Education .....	ext. 4845	Instructional Divisions	
Aspire Program.....	ext. 6396	Arts.....	ext. 5200
Assessment Center.....	ext. 4265	Business .....	ext. 4600
Bridge Program.....	ext. 5392	Humanities & Social Sciences .....	ext. 4570
Bookstore ("SacBookRac") .....	ext. 4475	Kinesiology, Athletics & Dance.....	ext. 4630
Bursar's Office.....	ext. 4960	Library & Learning Resources .....	ext. 5659
California Work Opportunity and Responsibility to Kids (CalWORKS) .....	ext. 4755	Natural Sciences .....	ext. 4425
Career and Transfer Services .....	ext. 4510	Technology & Health .....	ext. 4750
Child Development Center.....	ext. 4920	Learning Assistance Center .....	ext. 4300
Continuing Education.....	ext. 4220	Library.....	ext. 4260
Cooperative Agencies Resources for Education (CARE).....	ext. 4500	Lost & Found (Student Life).....	ext. 4525
Counseling Center .....	ext. 4380	Older Adult Program .....	ext. 4192
Directions to Campus.....	ext. 4181	Parking.....	ext. 4233
English as a Second Language (ESL). .....	ext. 5235	Police & Campus Safety .....	ext. 4555
Extended Opportunity Programs & Services (EOPS).....	ext. 4500	Police & Campus Safety Escort Service.....	ext. 4555
Financial Aid & Scholarships .....	ext. 4450	Student Life/Student Activities .....	ext. 4525
Health Center .....	ext. 4400	TRIO Programs:	
		ACES & Upward Bound.....	ext. 4411
		Veterans Resource Center .....	ext. 4520

# Registration — 8 Easy Steps

## REGISTRATION BEGINS FOR 2018 SUMMER SEMESTER Wednesday, May 9, 2018

### MAIN CAMPUS — (909) 274-7500

- **STEP 1 — Apply to Mt. SAC** (909) 274-4415  
The preferred method of application is via the Web at [www.mtsac.edu](http://www.mtsac.edu).  
**Mountie Fast Track Info Session:** Got questions? These Information Sessions were created to answer your questions and assist you in getting started at Mt. SAC! Register online at: <http://www.mtsac.edu/fasttrackinfosessions>
- **STEP 2 — Apply for Financial Aid** (909) 274-4450  
Apply for financial aid, fee waivers, and grants.
- **STEP 3 — Complete the Assessment Process** (909) 274-4265  
Complete the Assessment Questionnaire in your student portal.
- **STEP 4 — New Student Orientation** (909) 274-4380  
Attend an orientation session. Any student who is new to Mt. SAC MUST attend orientation before registering for classes.
- **STEP 5 — Counseling** (909) 274-4380  
Receive counseling/advising and your Mountie Academic Plan (MAP).
- **STEP 6 — Register** [inside.mtsac.edu](http://inside.mtsac.edu)  
Register online. If you need help, visit the Student Services Center.
- **STEP 7 — Fees** (909) 274-4960  
Pay your fees by credit card online, check by mail, or cash, check or credit card in person at Bursar's Office.

### STEP 1 — Apply to Mt. SAC

#### Who is eligible for Admission?

- A. Any person possessing a high school diploma or its equivalent or is at least 18 years old is eligible for admission to Mt. San Antonio College.
- B. High school juniors and seniors should apply online at [www.mtsac.edu](http://www.mtsac.edu). They will also need to submit a Special Admissions Application and meet the stated criteria. Admission is approved on an individual basis.

#### Special note to parents, Right of Access:

Under Section 49061 of the Education Code, parents of community college students do not have a right of access to their children's student records, regardless of whether the student is under the age of 18. In accordance with this regulation, students' college records will be released to parents only with the written consent of the student.

#### How Do I Apply?

- A. Apply online by visiting [www.mtsac.edu](http://www.mtsac.edu) and clicking on the "Apply Now" link.
- B. Students who are new to Mt SAC must apply online for admission. Returning Mt SAC students with an absence of two consecutive semesters (excluding Summer and Winter intersessions) must re-apply online for admission. Students who have attended Mt SAC within the past academic year do not need to re-apply.
- C. Submit official transcripts from all accredited high schools, colleges, and trade schools attended.

### STEP 2 — Apply for Financial Aid

Mt. SAC offers a variety of financial aid programs funded by federal and state agencies and private sources, including grants, fee waivers, work-study opportunities, scholarships, and loans. For further information, contact the Financial Aid Office at (909) 274-4450 or visit <http://www.mtsac.edu/financialaid>

### STEP 3 — Complete the Assessment Process

All Mt. SAC students are required to participate in assessment for course placement. The assessment and placement process has been established to enable all students the opportunity to be successful in their coursework. Please go to your student portal and complete the Assessment Questionnaire. Upon completion, you will be given your course placement or will be advised on your next step in the assessment process. For further information, contact the Assessment Center at (909) 274-4265 or visit Assessment online. (<http://www.mtsac.edu/assessment>)

# Registration — 8 Easy Steps

## STEP 4 — New Student Orientation

College counselors lead group orientation sessions for all new students who are enrolling at Mt.SAC, unless otherwise exempted. Students are exempt (but not prohibited) from participating in orientation, counseling and advising if they meet any of the following:

- A. Enroll in community service classes only
- B. Possess an Associate or higher degree from a regionally accredited institution
- C. Attain 60 units or more from a regionally accredited institution
- D. Select and enroll in a general interest class only.

All students must meet course prerequisites. Completion of orientation is required prior to registering for classes. Students may complete orientation in person or online. To schedule an orientation appointment, call (909) 274-4380, visit the Counseling Center in the Student Services Bldg or online at [www.mtsac.edu/counseling/orientation.html](http://www.mtsac.edu/counseling/orientation.html).

## STEP 5 — Counseling

College counselors lead group education planning sessions for new students who are enrolling at Mt. SAC. Students should complete assessment and have test results prior to participating in an education planning workshop. You will develop a first semester education plan.

## STEP 6 — Register

- A. View your assigned registration appointment by visiting [inside.mtsac.edu](http://inside.mtsac.edu). Login using your username and password, then you can view your assigned registration date and time. Students are not able to register before their assigned date and time.
- B. Prior to your registration appointment, review the *Schedule of Classes* and prepare a tentative class schedule. You will need to have the Course Reference Number (CRN) when you register online. Some classes may be closed at your registration time, so be prepared with some alternatives.
- C. You can search for open classes online at [www.mtsac.edu/searchforclasses/](http://www.mtsac.edu/searchforclasses/).
- D. You will be able to add yourself to wait lists for courses during registration.
- E. Check course prerequisites and corequisites. *A prerequisite is a course or experience which must be completed prior to enrollment in certain courses.* Be sure that you have completed the required prerequisites for the courses you have selected. Prerequisites are identified in the course descriptions in the *Schedule of Classes* and in the college Catalog.
- F. Be sure to register for required corequisites. *A corequisite is a course that must be taken during the same term as the course originally chosen.* Corequisites are identified in the course descriptions in the *Schedule of Classes* and in the college Catalog. Some corequisites may have been taken previously.

## STEP 7 — Fees

**Payment is due upon registration. Students who fail to pay for their classes by the established deadlines may be dropped. Students who remain enrolled after the course refund deadline remain financially responsible for the payment of fees even if they drop the class or are dropped by their instructor. Please check inside.mtsac.edu student portal for further information.**

**All fees are subject to change.**

### Fee Explanations

Contact the Bursar's Office at (909) 274-4960 with fee-related questions.

**Enrollment Fee:** The Enrollment Fee is \$46 per unit. Students who qualify for the California College Promise Grant -CCPG, (formerly Board of Governors fee waiver -BOGW) are not required to pay this fee.

**Non-Resident and International Student Tuition:** Out-of-state tuition fees are \$264 per unit and are re-

FEES (refer to Fee Explanations below)	Fees subject to change	
ENROLLMENT FEE	Resident	\$46 per unit
	International Students	\$310 per unit (\$264 per unit + \$46 per unit enrollment fee)
	Non-Resident Students	\$310 per unit (\$264 per unit + \$46 per unit enrollment fee)
STUDENT HEALTH FEE	Regular	\$17
	With CCPG	\$12
PARKING PERMIT	Regular	\$25
	With CCPG	\$25
STUDENT ACTIVITIES FEE	Collected in Fall and Spring semesters only	\$11
STUDENT REPRESENTATION FEE	Collected in Fall and Spring semesters only	\$0.50
STUDENT TRANSPORTATION FEE	Collected in Fall and Spring semesters only	\$8 part-time students \$9 full-time students

quired of all students who have not established residency in the State of California for a period of one year prior to the day before classes begin. International student tuition fees are \$264 per unit and are required of all non-resident international students attending Mt. SAC on an F-1 Visa. Contact Admissions & Records at (909) 274-4415 with residency questions.

**Student Health Fee:** Required of all credit students. Students who qualify for the California College Promise

# Fee Payment Options/Policies

Grant pay a reduced fee. Pursuant to Section 76355 of the Education Code, Mt. SAC has a process by which students may request to waive the health fee. To qualify for a waiver, students must provide documentation of active membership in a religious organization that relies exclusively upon prayer for healing. Applications for waivers are available in the Bursar's Office or in the Student Health Center (67B) for the first two weeks of the semester.

**Parking Permit:** A valid parking permit is required at all times to park on campus in all student parking lots. Parking permit replacement fees will apply.

**Student Activities Fee:** This fee is charged during Fall and Spring semesters for the purpose of providing book grants, scholarships, leadership opportunities, co-curricular programs and activities, and discounted amusement park and movie theater tickets. Refunds and waivers of this fee will not be approved after the second week of the semester.

**Student Transportation Fee:** Effective Summer 2015, a mandatory transportation fee for the Foothill Transit Class Pass Program will be charged to full and part-time students. California Education Code Section 76361 authorizes the governing board to require students to pay a fee for the purposes of partially or fully recovering transportation costs incurred by Mt. SAC.

**Student Representation Fee:** A mandatory fee that is collected during Fall and Spring Registration for the purpose of providing Mt. SAC students the means to advocate their positions and viewpoints before city, county and state government agencies.

**Additional fees paid at the Bursar's Office:**

- Material Cards & Field Trip Fees
- Verification Requests
- F-1 Student Application Fee (\$50)

## Owing a Debt to the College

Mt. SAC will withhold grades, transcripts, degrees, registration privileges, or any other combination thereof, from any student or former student who has failed to pay a valid financial obligation due to the College (e.g., returned check, unpaid loan, equipment breakage, financial aid overpayment, unpaid registration fee). Any item or items withheld shall be released when the student satisfactorily meets his/her financial obligation. When the outstanding financial obligation owed to the College is sent to our collection agencies, Chancellor's Office Tax Offset Program, the collection cost incurred will be added to the original amount owed. Returned checks must be paid in the form of cash, credit card, money order or a cashier's check, and a returned check charge of \$25 will be added to the amount of the check.

### Parking Permits

**Online:** After registering for classes, click on Student Portal #31 to order your parking permit through the permit vendor, Credentials Order Processing Services. Enter mailing address, license plate and registration information for each vehicle and provide credit card information. Our third party vendor will mail the permit within approximately 7-10 business days. A temporary permit may be printed to display until it arrives.

**In person:** Student parking permits can be purchased in person at the Bursar's Office (Building 4, lower level) during business hours. Vehicle license plate and registration information must be provided at the time of purchase. Payment for parking permit accepted by cash or check only.

## Fee Payment Options/Policies

- Payment is due upon registration.
- Any unpaid fees after the first day of the semester will result in a financial hold placed on your account. Financial holds will prevent students from enrollment, withdrawals, will prohibit access to transcripts and grades, and will limit access to certain campus services.
- Check your schedule to verify any course adds and/or drops.
- It is the student's responsibility to drop classes by the appropriate deadline as shown on the Student Schedule/Receipt. Students who remain enrolled after the course refund deadline remain financially responsible for payment of fees even if they drop the class or are dropped by their instructor.
- Students who fail to pay for their classes by the established deadlines will be dropped. Please check [inside.mtsac.edu](http://inside.mtsac.edu) student portal for established deadlines and further information.

**Fee payment may be made online, by mail, by dropbox, or in person.**

### Online Payments

Following online registration, fees can be paid online using VISA, MasterCard, Discover, American Express or a check card displaying the above logos. The payment link is # 25 on the Mt. Sac Student Portal, StudentTab.

### Mail Payments

Following online registration, fees can be paid by mailing a check or money order payable to Mt. SAC with the student ID number included on the check or money order. Mail to: **Bursar's Office, 1100 N. Grand Ave., Walnut, CA 91789. DO NOT MAIL CASH.**

### In-Person Payments

Following online registration, fees can be paid in person at the Bursar's Office in Building 4, Lower Level. The Bursar's office accepts cash, money orders, personal checks, business checks, Rehab vouchers, credit cards and cashier's checks.



# Fee Payment Options/Policies

## Drop Box Payments

Following online registration, fees can be submitted through the drop box by check or money order made payable to Mt. SAC with the student ID number included on the check or money order. **DO NOT LEAVE CASH.**

**Drop Box Location: Building 4, Lower Level, Bursar's Office.**

## Policy for Check Payment

- Checks must be written for exact amount only.
- All checks must be made payable to Mt. SAC (*third party checks are **not** acceptable*).
- Personal checks must have a pre-printed address imprinted on the check (***no** temporary checks*).
- Checks with written amount corrections are not acceptable.
- Post-dated checks are not acceptable.
- Students who have written two previous checks that have been returned for insufficient funds will not be allowed to write another check for registration.

## Policy for Credit Card Payment

- Visa, MasterCard, Discover, and American Express are accepted.
- Mt. SAC does not give cash advances or cash back on payments made with credit or debit cards.

## WHEN DO I REGISTER?

Check your registration appointment online for your date and time. You may not register prior to the date and time assigned. Register online at ***inside.mtsac.edu*** (6:00 a.m. - 11:00 p.m., Mon. - Sat.). Computers and staff are available for students to register in the Student Services Center.

### You may register during the following times

From	Begin Time To	End Time
Jan 15, 2015	07:00 am	Jun 14, 2015 11:59 pm

- ✓ You have no Holds which prevent registration.
  - ✓ Your Combined Academic Standing is Good Standing which
  - ✓ Your Student Status permits registration.
- Your Class for registration purposes is Freshman.

### Earned Credit

Level	Type	Hours
Credit	Transfer	0.000
Credit	Institutional	3.000
Non Credit	Institutional	0.000

### Curriculum Information

#### Current Program

Associate in Science

Level: Credit

Program: Psychiatric Tech AS Degree

Admit Term: Winter 2010

Admit Type: Standard

Catalog Term: Fall 2013

College: Mt. San Antonio College

Campus: Mt. San Antonio College

# Financial Aid and Scholarships

## Financial Aid

Mt. SAC offers a variety of financial aid programs funded by the federal and state government and private sources, including grants, fee waivers, work-study opportunities, scholarships, and loans. These programs are available to eligible students to help meet the cost of attending college. Students may apply for aid by filing a Free Application for Federal Student Aid (FAFSA) form at ***www.fafsa.gov***.

Eligible for the CA Dream Act? If you meet requirements for an AB 540 nonresident tuition exemption, you could be eligible for state and institutional aid. Apply online: ***https://dream.csac.ca.gov***.

Fee waivers to cover enrollment costs are available through the California College Promise Grant - CCPG program.

Apply online at: ***www.mtsac.edu/students/finaid***.

The Financial Aid Office is located on the upper level of the Students Services Center (9B); our phone number is (909) 274-4450. We have staff and computers available to help you complete financial aid forms.

## Scholarships

In addition to federal and state aid, scholarships are available to qualified students based on a number of factors, such as educational goal, major, need and/or merit.

The Mt. SAC Title IV code is: 001245

Students may submit a Mt. SAC Scholarship Program Application during the Spring semester of each year to be considered for over 100 scholarships.\*

Visit the Scholarship Program Office (Bldg. 9B) for assistance with researching on and off-campus scholarship opportunities, application assistance, personal essay advisement and monthly workshops/presentations.

Students may walk-in for general information or request an appointment by calling **(909) 274-4457**, or e-mailing ***scholarships@mtsac.edu***. For more info, visit ***www.mtsac.edu/scholarships/***.

*\*Funds are made available to students in the following Fall semester. Scholarship deadlines, eligibility information and applications are available on the Financial Aid tab of the ***inside.mtsac.edu*** student portal.*

# Online Registration

**STEP 1.** Log on to: *inside.mtsac.edu*

**STEP 2.** You will need to enter your **Username** and your **Password** to login.

**STEP 3.** Once you are in, click on **Student** Tab to display your menu. **(B)**

**STEP 4.** Click on **Student Self-Service Links** option No. 4. **(C)**

**STEP 5.** Click on **Select a Term.** **(D)**

**STEP 6.** Hit submit. **(E)**

**STEP 7.** Enter the five-digit **Course Reference Number (CRN)** in the area provided for each course you are trying to add (up to 10 classes at one time). **(F)**

**STEP 8.** Click on **Submit Changes** after you have entered all of your numbers. **(G)**

**Secure Login**

User Name:

Password:

Login Cancel

Home College Library **Student** Student Success

**Personal Announcements**

[Spring 2015] Online Services to help you this semester!  
Student Parking Available in Lot M  
Student Life Weekly Calendar  
Earn a free certificate in Leadership!  
2014 1098T Form Is Now Available

**Campus Announcements**

Phase 1 Perimeter Fence - Student Lot A  
Step Up: Improve Your Fitness  
Bursar's Office closed Friday, March 27, 2015

College Library **Student** Student Success Financial Aid eLearning Tools Noncredit

**Personal Announcements**

2015 Online Services to help you this semester!  
Parking Available in Lot M  
Life Weekly Calendar  
Free certificate in Leadership!  
1098T Form Is Now Available

**Campus Announcements**

Perimeter Fence - Student Lot A  
Improve Your Fitness  
Office closed Friday, March 27, 2015

**Student Self Service**

**Registration**

1. Apply for Admission
2. Review Existing Application
3. Select Term
4. Register (Add or Drop) Classes
5. Change Class Grading Option
6. Week at a Glance
7. Registration Fee Assessment
8. Registration Appointment/Hold
9. Active Registration
10. Registration History
11. Print Your Schedule/Receipt
12. Search for Classes
13. View Your Waitlist

**Student Records**

14. View Assessment/Placement Test Scores
15. View Holds
16. Final Grades
17. Grade Detail
18. View Unofficial Transcript
19. Request Official Transcript

Personal Information **Student** Financial Aid Employee Mailing Address

Search  Go

Registration Term

Select a Term: Spring 2015

Submit

Before attempting to register for a class, check to make sure the class is open (and the wait list is not filled) at the class schedule search ([https://prodssb.mtsac.edu/prod/pw\\_sigsched.p\\_Search](https://prodssb.mtsac.edu/prod/pw_sigsched.p_Search)). MTSAC's IT Acceptable Use policy ([http://www.mtsac.edu/administration/infosecurity/acceptable\\_use.html](http://www.mtsac.edu/administration/infosecurity/acceptable_use.html)) prohibits intentionally or negligently performing an act that computer or network to the extent that other users may be denied service. Use of scripts or excessive, repeated unsuccessful registration attempts may result in the placement of a temporary hold on your account.

To add a class, enter the Course Reference Number in the Add Classes section. To drop a class, use the options available in the Action pull-down list.

Without petitioning, students may enroll in up to 18 units each semester and up to 7 units each summer and winter intersession. Students who have completed a given semester with a grade point average of at least 3.0 and have a minimum cumulative grade point average of at least 3.0 may petition for permission to enroll in more than the maximum number of units allowed must contact the Counseling Office (X-4380).

**MAXIMUM NUMBER OF UNITS ENROLLED**

Term	Good Standing	Probation Standing
Spring/Fall	18	12
Winter/Summer	7	4

Add Classes Worksheet

CRNs

Submit Changes Class Search Reset

# Online Registration

**STEP 9.** The classes you successfully selected will be displayed.

**STEP 10.** Review your class schedule. (H)

**Mt. San Antonio College  
Student Schedule/Receipt  
Spring 2015**

H

Your Registration Begins: 15 JAN 2015 at 7:00am

**Schedule for 16-MAR-2015**

Enrolled Courses										
Crn	Subj	Crse	Title	Crd	Start Date	End Date	Times	Days	Bld	Rm
40973	ENGL	1A	Freshman Composition	4.0	23-FEB-15	14-JUN-15	12:00- 2:05pm	M W	26A	3620
41374	SPAN	1	Elementary Spanish	4.0	23-FEB-15	14-JUN-15	9:00- 1:15pm		F	66 248
41930	BIOL	21	Marine Biology Lab	1.0	23-FEB-15	14-JUN-15	9:45-12:55pm	T		7 1115
42098	KIN	34	Fitness for Living	3.0	23-FEB-15	14-JUN-15	9:45-11:10am	M W		45 1462
43074	BIOL	20	Marine Biology	3.0	23-FEB-15	14-JUN-15	1:15- 2:40pm	T R		11 2312
44211	BS	LANG1	Language Skills Laboratory	0.0	23-FEB-15	14-JUN-15	TBA			6 264

Additional Information							
Crn	Subj	Crse	Instructor	Email	Refund Deadline	Last Day to Drop Without a W	Last Day to Drop With a W
40973	ENGL	1A	Boehner-Staylor, Maya C.	mstaylor@mtsac.edu	06-MAR-15	08-MAR-15	01-MAY-15
41374	SPAN	1	Baler, Pablo F.	pbaler@mtsac.edu	06-MAR-15	08-MAR-15	01-MAY-15
41930	BIOL	21	Schmidt, Sherry E.	sschmidt@mtsac.edu	06-MAR-15	08-MAR-15	01-MAY-15
42098	KIN	34	Sanchez, Juan C.	jsanchez@mtsac.edu	06-MAR-15	08-MAR-15	01-MAY-15
43074	BIOL	20	Bava, Jose	jbava@mtsac.edu	06-MAR-15	08-MAR-15	01-MAY-15
44211	BS	LANG1	Marcy, Peggy C.	pmarcy@mtsac.edu	12-JUN-15	12-JUN-15	12-JUN-15

**Account Information**

Any unpaid fees that result after the semester begins will be placed on a financial hold. Financial holds will prevent students from enrollment, transcripts, withdrawals and prohibit access to certain campus services.

It is the student's responsibility to drop classes by the appropriate deadline as shown above. Students who remain enrolled after the refund deadline are not eligible for a refund and remain financially responsible for payment of fees even if they drop the class or are dropped by their instructor.

Account Summary for			
			Account Balance: \$0.00
<b>Spring 2015</b>			
Detail Code	Description	Charge	Payment Balance
ENRL	Enrollment	\$690.00	\$0.00
HTHF	Health Fee	\$19.00	\$0.00
SREP	Student Representation Fee	\$0.50	\$0.00
STAF	Student Activity Fee	\$11.00	\$0.00
VSA2	Visa (Web Credit Cards)		\$720.50
			\$0.00

## Fee Waiver

### California College Promise Grant - CCPG (formerly Board of Governors fee waiver - BOGW)

The California College Promise Grant waives the enrollment fee and provides a reduced cost for health and parking fees. Students are responsible for paying any additional fees.

This assistance is available to qualified California residents. There are three methods by which students may qualify:

**Method A:**

A student is currently a recipient of funds from TANF (Temporary Assistance for Needy Families), SSI (Supplemental Security Income), or GA/GR (General Assistance/ General Relief), or, if a dependent, such funds are the sole source of income for the family.

Students must provide a current copy of their check or an Untaxed Income Verification form, available online at [www.mtsac.edu/students/finaid/forms.html](http://www.mtsac.edu/students/finaid/forms.html)

**Method B:**

Household size and annual family income. Colleges may ask students to provide documentation of income, such as a copy of their Federal Income Tax Return. **Students are required to provide documentation if it is requested.**

**Method C:**

A student has applied for other state/federal aid and has demonstrated financial need by completing the Free Applica-

tion for Federal Student Aid (FAFSA) form. Method C is the preferred method as most students that do not qualify for a fee waiver based on Methods A and B, do qualify when they file the FAFSA.

**Visit [www.cccapply.org/money](http://www.cccapply.org/money) to apply online.**

*Students may also download the application form from the website and return it in person to the Financial Aid Office (Bldg. 9B).*

Students may apply for a CCPG at any point during the academic year. If students are determined eligible for a CCPG, it will be valid for the entire academic year. Students must reapply for a CCPG each year beginning with the summer term. Please refer to the Refund for CCPG policy on page 21 for information regarding refunds. CCPG recipients are subject to loss of CCPG eligibility when they are on probation for two consecutive semesters with academic and/or progress probation. Only students identified as foster youth are exempt from this rule. There are provisions for regaining eligibility and an appeal process. You can find out more details at: [www.mtsac.edu/financialaid/types-of-aid/state-aid-programs.html](http://www.mtsac.edu/financialaid/types-of-aid/state-aid-programs.html)

**NOTE: Since verification of eligibility may involve contact with other agencies, parental signature, or other documents, it is reasonable to expect that an application may not be completed on the same day it is submitted.**

# How To Add Yourself To A Wait List

**STEP 1.** Type the five-digit Course Reference (CRN) in the area provided for each course you are trying to add. **(A)**

**STEP 2.** After you hit the Submit Changes button, you will receive the following message. **(B)**

**STEP 3.** Click on the Action box, select Wait List. **(C)**

**STEP 4.** You will see the following message indicating you are now on the Wait List. **(D)**

Back to Student's Registration Tab

Before attempting to register for a class, check to make sure the class is open (and the wait list is not filled) at the class schedule search page ([https://prodsb.mtsac.edu/prod/pw\\_sigsched.p\\_Search](https://prodsb.mtsac.edu/prod/pw_sigsched.p_Search)). Mt. SAC's IT Acceptable Use policy ([http://www.mtsac.edu/administration/infosecurity/acceptable\\_use.html](http://www.mtsac.edu/administration/infosecurity/acceptable_use.html)) prohibits intentionally or negligently performing an act that places an excessive computer or network to the extent that other users may be denied service. Use of scripts or excessive, repeated unsuccessful registration attempts may result in the placement of a temporary hold on your account.

To add a class, enter the Course Reference Number in the Add Classes section. To drop a class, use the options available in the Action pull-down list.

Without petitioning, students may enroll in up to 18 units each semester and up to 7 units each summer and winter intercession. Students who have completed a minimum of 15 college units in a given semester with a grade point average of at least 3.0 and have a minimum cumulative grade point average of at least 3.0 may petition for permission to enroll in units above the maximum. Students wishing to exceed the maximum number of units allowed must contact the Counseling Office (X-4380).

MAXIMUM NUMBER OF UNITS ENROLLED		
Term	Good Standing	Probation Standing
Spring/Fall	18	12
Winter/Summer	7	4

Add Classes Worksheet

CRNs

Submit Changes Class Search Reset

---

Click here to Register to Vote

Before attempting to register for a class, check to make sure the class is open (and the wait list is not filled) at the class schedule search page ([https://prodsb.mtsac.edu/prod/pw\\_sigsched.p\\_Search](https://prodsb.mtsac.edu/prod/pw_sigsched.p_Search)). Mt. SAC's IT Acceptable Use policy ([http://www.mtsac.edu/administration/infosecurity/acceptable\\_use.html](http://www.mtsac.edu/administration/infosecurity/acceptable_use.html)) prohibits intentionally or negligently performing an act that places an excessive load on a computer or network to the extent that other users may be denied service. Use of scripts or excessive, repeated registration attempts may result in the placement of a temporary hold on your account.

To add a class, enter the Course Reference Number in the Add Classes section. To drop a class, use the options available in the Action pull-down list.

Without petitioning, students may enroll in up to 18 units each semester and up to 7 units each summer and winter intercession. Students who have completed a minimum of 15 college units in a given semester with a grade point average of at least 3.0 and have a minimum cumulative grade point average of at least 3.0 may petition for permission to enroll in units above the maximum. Students wishing to exceed the maximum number of units allowed must contact the Counseling Office (X-4380).

MAXIMUM NUMBER OF UNITS ENROLLED		
Term	Good Standing	Probation Standing
Spring/Fall	18	12
Winter/Summer	7	4

Registration Add Errors

Status	Action	CRN	Subj	Crse	Sec	Level	Cred	Grade	Mode	Title
Closed To waitlist this class select WaitList from the drop down list and click on "Submit Changes."	None	41275	SPCH	1A	25	Credit	4.000	Standard	Letter	Grade Public Speaking

Add Classes Worksheet

CRNs

Submit Changes Class Search Reset

---

Click here to Register to Vote

Before attempting to register for a class, check to make sure the class is open (and the wait list is not filled) at the class schedule search page ([https://prodsb.mtsac.edu/prod/pw\\_sigsched.p\\_Search](https://prodsb.mtsac.edu/prod/pw_sigsched.p_Search)). Mt. SAC's IT Acceptable Use policy ([http://www.mtsac.edu/administration/infosecurity/acceptable\\_use.html](http://www.mtsac.edu/administration/infosecurity/acceptable_use.html)) prohibits intentionally or negligently performing an act that places an excessive load on a computer or network to the extent that other users may be denied service. Use of scripts or excessive, repeated registration attempts may result in the placement of a temporary hold on your account.

To add a class, enter the Course Reference Number in the Add Classes section. To drop a class, use the options available in the Action pull-down list.

Without petitioning, students may enroll in up to 18 units each semester and up to 7 units each summer and winter intercession. Students who have completed a minimum of 15 college units in a given semester with a grade point average of at least 3.0 and have a minimum cumulative grade point average of at least 3.0 may petition for permission to enroll in units above the maximum. Students wishing to exceed the maximum number of units allowed must contact the Counseling Office (X-4380).

MAXIMUM NUMBER OF UNITS ENROLLED		
Term	Good Standing	Probation Standing
Spring/Fall	18	12
Winter/Summer	7	4

Registration Add Errors

Status	Action	CRN	Subj	Crse	Sec	Level	Cred	Grade	Mode	Title
Closed To waitlist this class select WaitList from the drop down list and click on "Submit Changes."	Wait List	41275	SPCH	1A	25	Credit	4.000	Standard	Letter	Grade Public Speaking

Add Classes Worksheet

CRNs

Submit Changes Class Search Reset

---

Click here to Register to Vote

Before attempting to register for a class, check to make sure the class is open (and the wait list is not filled) at the class schedule search page ([https://prodsb.mtsac.edu/prod/pw\\_sigsched.p\\_Search](https://prodsb.mtsac.edu/prod/pw_sigsched.p_Search)). Mt. SAC's IT Acceptable Use policy ([http://www.mtsac.edu/administration/infosecurity/acceptable\\_use.html](http://www.mtsac.edu/administration/infosecurity/acceptable_use.html)) prohibits intentionally or negligently performing an act that places an excessive load on a computer or network to the extent that other users may be denied service. Use of scripts or excessive, repeated registration attempts may result in the placement of a temporary hold on your account.

To add a class, enter the Course Reference Number in the Add Classes section. To drop a class, use the options available in the Action pull-down list.

Without petitioning, students may enroll in up to 18 units each semester and up to 7 units each summer and winter intercession. Students who have completed a minimum of 15 college units in a given semester with a grade point average of at least 3.0 and have a minimum cumulative grade point average of at least 3.0 may petition for permission to enroll in units above the maximum. Students wishing to exceed the maximum number of units allowed must contact the Counseling Office (X-4380).

MAXIMUM NUMBER OF UNITS ENROLLED		
Term	Good Standing	Probation Standing
Spring/Fall	18	12
Winter/Summer	7	4

Current Schedule

Status	Action	CRN	Subj	Crse	Sec	Level	Cred	Grade	Mode	Title
Wait List on Mar 16, 2015	None	41275	SPCH	1A	25	Credit	0.000	Standard	Letter	Grade Public Speaking

Total Credit Hours: 0.000  
 Billing Hours: 0.000  
 Minimum Hours: 0.000  
 Maximum Hours: 18.000  
 Date: Mar 16, 2015 03:07 pm

# How To Add Yourself To A Wait List

**STEP 5.** To view your wait list course(s), Select Self Service Links No. 13 - View your waitlist from the Student tab. **(E)**

**STEP 6.** You will see the date you placed yourself on the Wait List and Position. **(F)**

**STEP 7.** You will be notified via your Mt. SAC Email Account when an opening is available and given 72 hours to enroll in the course.

**STEP 8.** Go to your portal and select Student Tab and Select Self Service Links option No. 4. under the Action tab. Click on the drop down arrow and select Web Registered, make sure you hit Submit Changes. **(G)**

### Student Self Service

#### Registration

1. Apply for Admission
2. Review Existing Application
3. Select Term
4. Register (Add or Drop) Classes
5. Change Class Grading Option
6. Week at a Glance
7. Registration Fee Assessment
8. Registration Appointment/Hold
9. Active Registration
10. Registration History
11. Print Your Schedule/Receipt
12. Search for Classes
13. View Your Waitlist

E

#### Student Records

14. View Assessment/Placement Test Scores
15. View Holds
16. Final Grades
17. Grade Detail
18. View Unofficial Transcript
19. Request Official Transcript
20. View Status of transcript Request
21. View College Catalog
22. View Student Information
23. Request Enrollment Verification

Personal Information **Student** Employee Finance
RETURN TO MENU SITE MAP HELP

Search

### Student Detail Schedule

Total Credit Hours: 0.000

**Public Speaking - SPCH 1A - 25**

Associated Term: Spring 2015  
 CRN: 41275  
 Status: Wait List on Mar 16, 2015  
 Waitlist Position: 1  
 Notification Expires:  
 Assigned Instructor: John W. Vitullo

Grade Mode: Standard Letter Grade  
 Credits: 0.000  
 Level: Credit  
 Campus: Mt. San Antonio College

**Scheduled Meeting Times**

Type	Time	Days	Where	Date Range	Schedule Type	Instructors	Email	Office Location Of
Class	10:45 am - 12:50 pm	MTWR	Bldg. 21H 1	Apr 20, 2015 - Jun 14, 2015	Lecture and/or discussion	John W Vitullo (P)	jvitullo@mtsac.edu	

---

### Current Schedule

Status	Action	CRN	Subj	Crse	Sec	Level	Cred	Grade Mode	Title
Wait List on Mar 17, 2015	<div style="border: 1px solid gray; padding: 2px; display: inline-block;">                     None                      Drop Before Class Begins                      **Web Registered**                 </div>	41261	SPCH	1A	10	Credit	0.000	Standard Letter Grade	Public Spee

Total Credit Hours: 0.000  
 Billing Hours: 0.000  
 Minimum Hours: 0.000  
 Maximum Hours: 18.000  
 Date: Mar 17, 2015 11:46 am

### Add Classes Worksheet

**CRNs**

--	--	--	--	--	--	--	--	--

**G**

**F**

# Paying Fees Online

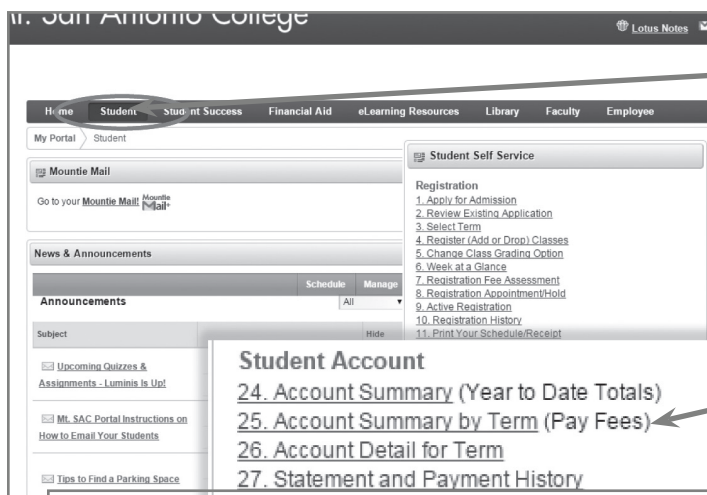

**STEP 1.** Login to the Mt. SAC portal.

**STEP 2.** Click on the Student tab. **(A)**

**STEP 3.** Click on #25. Account Summary by Term (Pay Fees) **(B)** under the Student Self-Service links.

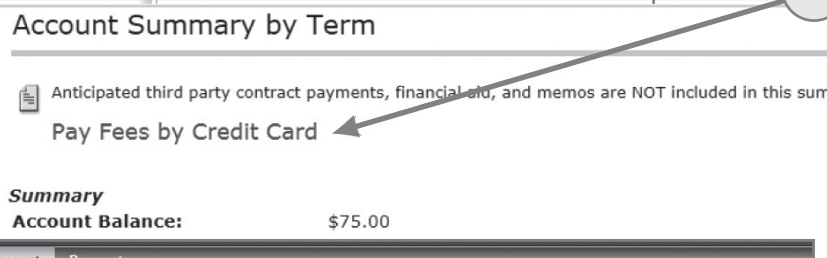

**STEP 4.** Verify your fees, then click on Pay Fees by Credit Card. **(C)**

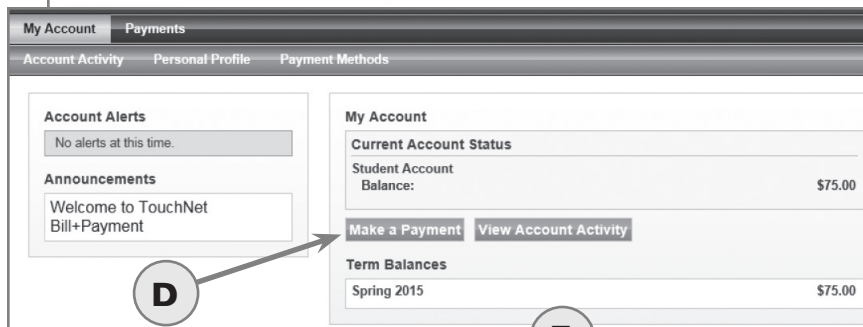

**STEP 5.** Click on Make a Payment. **(D)**



**STEP 6.** The balance will display once again, click Make a Payment. **(D)**

**STEP 7.** Select payment: Click on Current account balance or Pay by term **(E)** and click Continue.

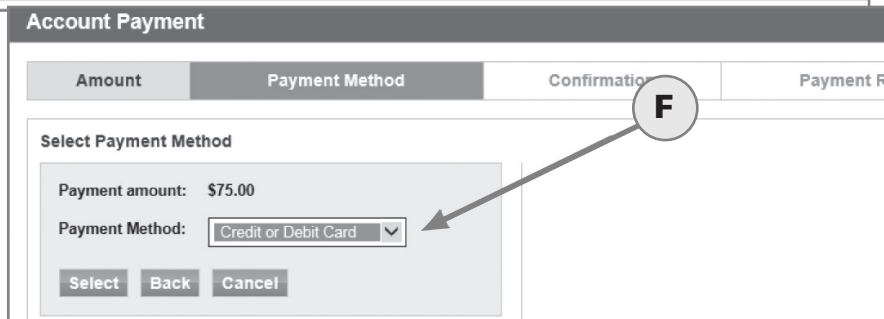

**STEP 8.** Select Payment Method: Click on the dropdown menu to select Credit or Debit Card **(F)** and click Select.

# Paying Fees Online

**STEP 9.** Fill in credit or debit card number and click Continue. **(G)**

**STEP 10.** Verify information and click Submit Payment **(H)**

**STEP 11.** Once you see the payment receipt (print for your records), then click on Log Out. **(I)**

Amount	Payment Method	Confirmation	Payment Receipt
Payment date:	3/4/16		
Amount Paid:	\$75.00		
Transaction type:	Purchase		
Student Name:	Joe Mountie		
Paid to:	Mount San Antonio College 1100 N. Grand Ave Walnut, CA 91789 UNITED STATES		
Web address:	https://test.secure.touchnet.net:8443/C20144test_tsa/web/		
Account number:	xxxxxxxxxxxx1111		
Name on Card:	Joe Mountie		
Card not present for this transaction.			

**STEP 12.** Navigate back to your portal. Click on Student Self-Service Links Option # 11-Print your Schedule/Receipt **(J)** and verify you have no fees.

Crn	Subj	Crse	Title	Crd	Start Date	End Date	Times
40973	ENGL	1A	Freshman Composition	4.0	23-FEB-15	14-JUN-15	12:00-2:05pm
41374	SPAN	1	Elementary Spanish	4.0	23-FEB-15	14-JUN-15	9:00-1:15pm
41930	BIOL	21	Marine Biology Lab	1.0	23-FEB-15	14-JUN-15	9:45-12:55pm
42098	KIN	34	Fitness for Living	3.0	23-FEB-15	14-JUN-15	9:45-11:10am
43074	BIOL	20	Marine Biology	3.0	23-FEB-15	14-JUN-15	1:15-2:40pm
44211	BS	LANG1	Language Skills Laboratory	0.0	23-FEB-15	14-JUN-15	TBA

Detail Code	Description	Charge	Payment	Balance
ENRL	Enrollment	\$690.00	\$0.00	\$0.00
HTHF	Health Fee	\$19.00	\$0.00	\$0.00
SREP	Student Representation Fee	\$0.50	\$0.00	\$0.00
STAF	Student Activity Fee	\$11.00	\$0.00	\$0.00
VSA2	Visa (Web Credit Cards)	\$720.60	\$0.00	\$0.00
Term Charges:		\$720.60		
Term Credits:		\$720.60		
Term Balance:		\$0.00	\$0.00	\$0.00
Previous Balance:		\$0.00		
Account Balance:		\$0.00		\$0.00

# TouchNet: Authorized Users

TouchNet gives students the ability to authorize access to their payment information to another individual (e.g., parent, guardian). To do so, the student must first add the individual to their account by following the steps below. The system will then assign the individual his/her own login ID and password to log in and make payments for the student (instructions on pg.4). Returning authorized users can go to <http://www.mtsac.edu/payments> to login.

## ADDING AN AUTHORIZED USER:

- STEP 1.** Login to the Mt. SAC portal.
- STEP 2.** Click on the Student tab (A).
- STEP 3.** Click on #25. Pay Fees (B) under the Student Self-Service links.
- STEP 4.** Click on Pay Fees by Credit Card (C).
- STEP 5.** Click on the Authorized Users tab (D).
- STEP 6.** Enter E-mail address of authorized user in the designated box.
- STEP 7.** Select Yes or No on the question regarding payment history.
- STEP 8.** Click Continue.

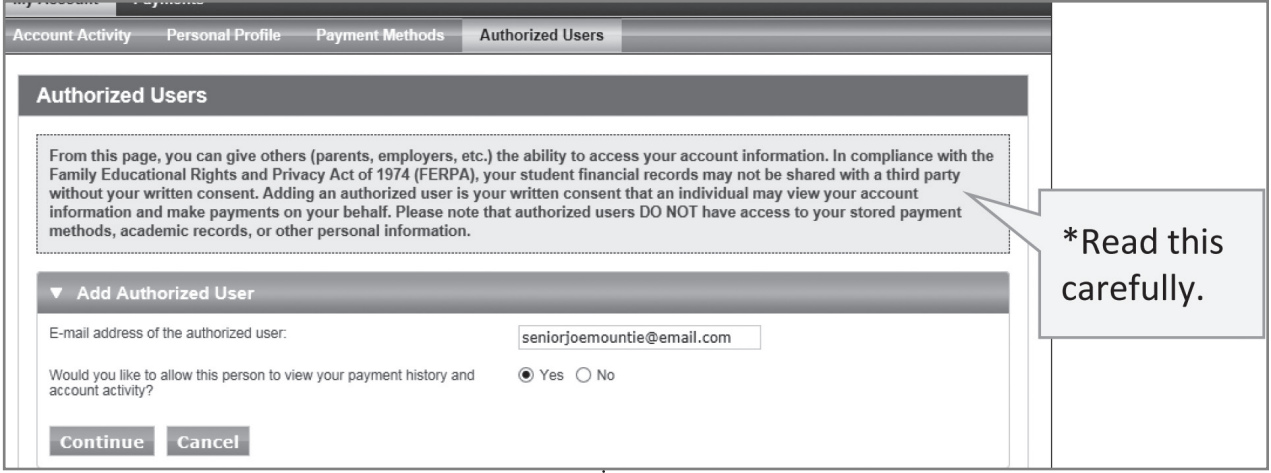
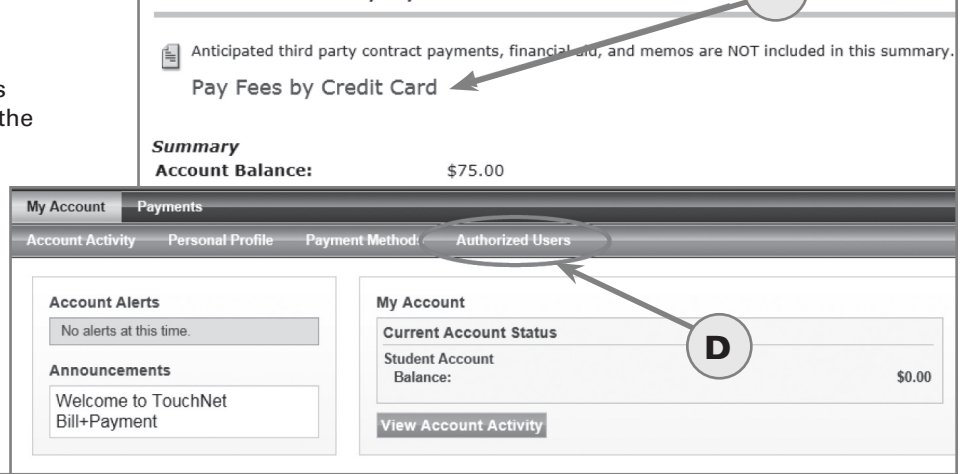
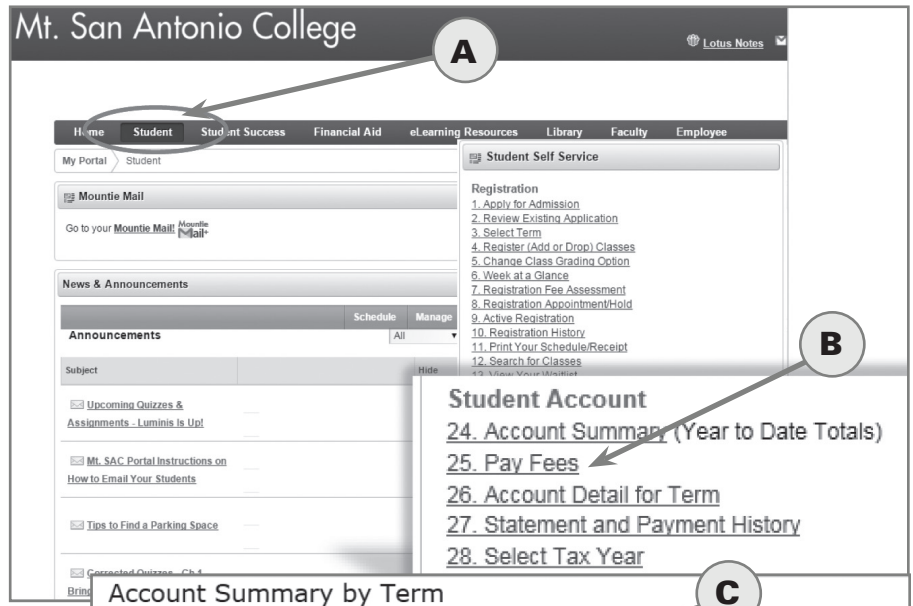



# TouchNet: Authorized Users

**Agreement to Add Authorized User**

I hereby authorize **Mount San Antonio College** to grant **seniorjoemoutie@gmail.com** partial access to my accounts, including ability to view my payment history and/or make payments accordingly. My payment methods, billing statements, and credit card and/or checking account information will remain confidential and hidden from all other users. I understand that I am still primarily responsible for ensuring that all my accounts are paid on time and in full.

This agreement is dated Tuesday, November 15, 2016.

For fraud detection purposes, your internet address has been logged:  
140.144.127.1 at 11/15/16 1:31:58 PM PST

**ANY FALSE INFORMATION ENTERED HEREON CONSTITUTES AS FRAUD AND SUBJECTS THE PARTY ENTERING SAME TO FELONY PROSECUTION UNDER BOTH FEDERAL AND STATE LAWS OF THE UNITED STATES. VIOLATORS WILL BE PROSECUTED TO THE FULL EXTENT OF THE LAW.**

Please check the box below to agree to the terms and continue.

I Agree

[Print Agreement](#) [Continue](#) [Cancel](#)

**STEP 9.** Read the agreement prompt carefully and check I Agree, if you agree with the terms. If you do not agree click Cancel to end the process (E).

**STEP 10.** Click Print Agreement if you wish and/or click on Continue.

**My Account** | **Payments**

Account Activity | Personal Profile | Payment Methods | **Authorized Users**

**Authorized Users**

Thank you. We have sent an e-mail to **ejeda002@gmail.cpm** with instructions on how to log in and view your payment plan information. This person will log in using the e-mail address you provided.  
(Note: If the e-mail delivery fails for some reason, a notification MAY be sent to your e-mail address on record.)

From this page, you can give others (parents, employers, etc.) the ability to access your account information. In compliance with the Family Educational Rights and Privacy Act of 1974 (FERPA), your student financial records may not be shared with a third party without your written consent. Adding an authorized user is your written consent that an individual may view your account information and make payments on your behalf. Please note that authorized users DO NOT have access to your stored payment methods, academic records, or other personal information.

**Current Authorized Users**

When you delete an authorized user, that person will no longer be able to make payments to your accounts. Any scheduled payments by that person that have not already been applied will be cancelled.

Full name:	E-mail address:	Action
	ejeda002@gmail.cpm	Edit   Delete   Show Agreement

\*You can edit or delete authorized user in this screen.

**Students and Staff**

\*Indicates required information  
\*University ID:   
\*Pin:   
[Login](#)

**Authorized Users**

Login for parents or others who have been granted access.

\*E-mail:   
\*Password:   
[Login](#)

Forgot your password?  
Have a temporary password e-mailed to you.

**Welcome**

Welcome to Mount San Antonio College Student Account Suite. This site is a 24x7 service offered to students and their families for making payments and managing their student account.

Students and staff may log in using their University ID and Pin. Parents, guardians, or employers wishing to access the system require student permission via the student's authorized user process. If you have any questions about the system, please send e-mail to [bursar@mtsac.edu](mailto:bursar@mtsac.edu).

**Student Account Suite Features**

**Student Account Center**

- Check your balance.
- Make a payment towards your balance.
- View your payment history.
- Store your payment methods for quick and easy payment.
- As a student, provide permission to others (parents, employers, etc) to make payments.

**STEP 11.** An email will be sent to the authorized user with instructions on how to login and view payment information.

**AUTHORIZED USER LOGIN:**

**STEP 1.** Click on the link provided in the email sent to you by [Studentinfo@mtsac.edu](mailto:Studentinfo@mtsac.edu) and enter your login information provided in the email (F). Returning users click here to login.

**My Account** | **Payments**

Account Activity | Personal Profile | Payment Methods | **Select Student**

Cancelled making payment!

**Account Alerts**

No alerts at this time.

**Announcements**

Welcome to TouchNet Bill+Payment

**My Account**

**Current Account Status**

Student Account Balance:

[View Account Activity](#)

**STEP 2.** Fill in your personal information and type in a new password to complete your profile. Click Save.

**STEP 3.** Click on View Account Activity to make a payment (G).

# Prerequisites, Corequisites and Advisories

## Prerequisites and Advisories

Faculty at Mt. SAC have established prerequisites, corequisites and advisories for courses. Please refer to the course descriptions in the *Schedule of Classes* or college *Catalog* for prerequisites, corequisites and advisories. **If students do not meet the prerequisite or corequisite requirements, they will be blocked from enrolling in those courses.** Transcripts and grade report cards from other colleges must be evaluated prior to registration to satisfy pre- and corequisites.

### Prerequisite

Prerequisites to a course are those courses which must have been taken previously as preparation for the course. To enroll in a class that has a prerequisite, students must complete the required preparation prior to enrolling in the course. In some instances, **English, Reading, Math and Chemistry prerequisites** may be met by attaining eligibility through assessment. All **course prerequisites** listed must be completed with a grade of "C" or better, unless otherwise stated.

### Corequisite

To enroll in a course that has a corequisite, the corequisite course must be taken at the same time. In some instances, a corequisite may have been taken previously.

### Advisory

An advisory to a course is preparation which is highly recommended by faculty teaching the course. Although students may enroll in a course if they do not possess the advisory skills, they are encouraged to abide by an advisory whenever possible.

## IMPORTANT NOTE TO STUDENTS

**To comply with State law, students enrolled in courses with prerequisite requirements will be automatically dropped from any course where those prerequisites have not been completed. This may occur if they were enrolled in the prerequisite course at the time they registered for the current term and failed to complete that course successfully.**

**Students who are uncertain about their status regarding completion of prerequisite requirements may go to Counseling Center for assistance.**

**If a student is currently enrolled in the prerequisite course and is not sure of the grade, he or she may:**

- 1) Check with the instructor, or**
- 2) Go to the appropriate Division Office the first day of the new semester.**

**Students will receive notification if they are dropped from any course for this reason.**

## Prerequisite Challenge Process

In accordance with Title 5 Section 55003 (p) and (q), Student Challenge of Prerequisites or Corequisites, students may challenge a prerequisite or corequisite for a course. A prerequisite or corequisite cannot be "waived," but students have the ability to demonstrate that they meet the prerequisite or corequisite on the following criteria, and course eligibility may be granted. The challenge must be based on at least one of the following specific grounds:

- The College will accept prerequisite or corequisite courses from regionally accredited colleges and universities in the United States. (The student will meet with the appropriate department chair)
- A student may request a prerequisite or corequisite variance to demonstrate that the student has the knowledge or ability equivalent to the prerequisite or corequisite for the course in question, but has not formally met the established prerequisite or corequisite. (The student will meet with the appropriate department chair)
- The prerequisite or corequisite course has not been made reasonably available, and waiting until the prerequisite or corequisite is offered will create an undue delay in meeting educational goals. (The student will meet with the Director of Assessment and Matriculation)
- The prerequisite or corequisite is being applied in a discriminatory manner. (The student will meet with the Director of Assessment and Matriculation)
- The prerequisite violates the provisions of the State Education Code. (The student will meet with the Director of Assessment and Matriculation)

# Placement Test Information

## Placement Test Information

### ATTENTION STUDENTS:

All Mt. SAC students are required to participate in assessment for course placement. The assessment and placement process has been established to enable all students the opportunity to be successful in their coursework. The Assessment Center provides assessment services to assure that all students are placed appropriately in Mt. SAC courses.

Please go to your student portal and complete the Assessment Questionnaire. Upon completion, you will be given your course placement or will be advised on your next step in the assessment process. Most students will be placed in courses based on their performance in high school. In some instances, students will be referred to the Assessment Center to take their placement tests which will assist in their course placement. For those who take a placement test, please note:

- Students may retest after three months
- Test scores are valid for two years
- A valid photo I.D. is required to take ALL tests and to obtain test results

For further information, contact the Assessment Center at (909) 274-4265 or visit Assessment online. (<http://www.mtsac.edu/assessment>)

### The following tests may be taken at the Assessment Center:

#### English Placement Test

#### Assessment of Written English (AWE) 1 hour\*

This is a test of your abilities in language usage. It is required for placement in English classes (*including LERN, AMLA, and ESL classes*). The AWE is used to provide eligibility for the following courses:

<b>ESL</b>	English as a Second Language
<b>AMLA 41W</b>	American Language, Basic Writing
<b>AMLA 42W</b>	American Language, Intermediate Writing
<b>AMLA 43W</b>	American Language, Advanced Writing
<b>LERN 81</b>	Improving Writing
<b>ENGL 67<sup>1</sup></b>	Writing Fundamentals
<b>ENGL 68<sup>2</sup></b>	Preparation for College Writing
<b>ENGL 90<sup>1</sup></b>	Accelerated Developmental Writing
<b>ENGL 1A</b>	Freshman Composition

<sup>1</sup>Students eligible for ENGL 67 have two options: A) Enroll in ENGL 67; or B) Enroll in ENGL 90. Students will be eligible to enroll in ENGL 1A after successful completion of ENGL 90.

<sup>2</sup>Students eligible for ENGL 68 have two options: A) Enroll in ENGL 68; or B) Concurrently enroll in both ENGL 1A and ENGL 66 - Paragraph Writing.

#### Reading Placement Test Degrees of Reading Power (DRP)

This is a test of your current reading abilities. The results will be used to provide eligibility for the following courses:

#### Degrees of Reading Power (DRP)

<b>READ 70</b>	Improving Reading Comprehension
<b>READ 80</b>	Developing Reading Comprehension
<b>READ 90</b>	Preparing for College Reading
<b>READ 100</b>	Analysis and Critical Reading

#### Mt. SAC Math Placement Test 1 hour\*

This is a test of your arithmetic and pre-algebra skills.

The appropriate test score will provide eligibility for the following courses. **Please see the course descriptions in the *Schedule of Classes* for prerequisites.**

<b>LERN 48</b>	Basic Math Skills Review
<b>LERN 49</b>	Math Skills Review
<b>MATH 50</b>	Pre-Algebra
<b>MATH 51<sup>3</sup></b>	Elementary Algebra
<b>MATH 51A</b>	Elementary Algebra - First Half
<b>MATH 70S<sup>3</sup></b>	Integrated Intermediate Algebra

<sup>3</sup>Students eligible for MATH 51 may enroll in MATH 70S. Students will be eligible to enroll in MATH 110S-Integrated Statistics after successful completion of MATH 70S.

#### Intermediate Algebra Placement Test 1 hour\*

This is a test of your elementary algebra skills. The appropriate test score will provide eligibility for the following courses. **Please see the course descriptions in the *Schedule of Classes* for prerequisites.**

<b>MATH 61</b>	Plane Geometry
<b>MATH 71</b>	Intermediate Algebra
<b>MATH 71A</b>	Intermediate Algebra – First Half
<b>MATH 71X</b>	Practical Intermediate Algebra

#### College Level Math Placement Test 1 hour\*

This is a test of your intermediate algebra skills. The appropriate test score will provide eligibility for the following courses. **Please see the course descriptions in the *Schedule of Classes* for prerequisites.**

<b>MATH 100</b>	Survey of College Mathematics
<b>MATH 110</b>	Elementary Statistics
<b>MATH 120</b>	Finite Mathematics
<b>MATH 130</b>	College Algebra
<b>MATH 150</b>	Trigonometry
<b>MATH 160</b>	Pre-Calculus Mathematics (Trigonometry Supplement Test may also be required)

#### Calculus Placement Test 1 hours\*

This is a test of your algebra and trigonometry skills. The appropriate test scores will provide eligibility for the following courses. **Please see the course descriptions in the *Schedule of Classes* for prerequisites.**

<b>MATH 140</b>	Calculus for Business
<b>MATH 180</b>	Calculus and Analytic Geometry

#### Chemistry Placement Test 1 hour\*

Appropriate test scores AND transcripts verifying successful completion of the required courses will provide eligibility for the following course. **Please see the course descriptions in the *Schedule of Classes* for prerequisites.**

<b>CHEM 50</b>	General Chemistry I
----------------	---------------------

\* Not actual test time. Time indicated may vary slightly depending on time necessary for administration and instructions.

#### Exemption from Assessment

A student is exempt from assessment if the student has:

1. completed an Associated degree or higher from a regionally accredited institution;
2. enrolled at the College for a reason other than career development or advancement, transfer, attainment of a degree, or certificate of achievement, or

# Placement Test Information

- completion of a basic skills, or English as a Second Language course sequence;
- completed these services at another community college within a time period identified by the College;
  - enrolled at the College solely to take a course that is legally mandated for employment as defined Section 55000 or necessary in response to a significant change in industry or licensure standards;
  - enrolled at the College as a special admission student pursuant to Education Code section 76001.

## Test Scores from Other Colleges

The Assessment Center will accept math test scores from other colleges that use the Mathematics Diagnostic

Testing Project (MDTP) placement tests if the test was taken less than two years ago. An official copy of the test scores must be brought or mailed to the Assessment Center for evaluation and course placement. The following are placement levels for the tests we accept:

### MDTP – Elementary Algebra Test

MATH 71                  MATH 61

### MDTP – Intermediate Algebra Test

MATH 100                MATH 110                MATH 120  
MATH 130                MATH 150                MATH 160

### MDTP – Pre-Calculus Test

MATH 140                MATH 180

Mt. SAC **does not** accept English Placement test scores from other colleges.

# Changing Your Class Schedule

## Changing Your Class Schedule

You can make changes to your course schedule by using the Online Registration System.

- You may drop classes.
- You may add open classes or any class for which you have an ADD Authorization Code.
- You may search for open sections at [www.mtsac.edu/searchforclasses/](http://www.mtsac.edu/searchforclasses/)
- It is your responsibility to know deadlines to add courses and to drop courses that you are no longer attending. You must use the online registration system to drop classes.
- You must pay the required fee for any added class and drop by the course refund deadline on student Schedule/Receipt to qualify for a refund (*see page 21*).

## Adding or Dropping a Class

### A. To Add an Open Class:

- You may add open classes online at ***inside.mtsac.edu***. Verify your add by printing your schedule/receipt.
- Once classes start, you must attend the first class meeting to obtain an ADD Authorization Code if the class is no longer available through the registration system. Instructors will add students depending on the number of open spaces in the class.
- You must have your Mt. SAC registration appointment printout of your assigned date and time, along with a picture ID.**
- You must be **eligible** (*have the appropriate prerequisite*) for the class. Prerequisites will be checked by the system at the time you register for the class. If you are blocked from registering for a class and believe that you do possess the appropriate prerequisite, or if you have a question regarding the prerequisite, call Admissions and Records at **(909) 274-4415** for assistance.
- You must register for all ADDs prior to the expiration date on the ADD Authorization Code.

- You MUST have a picture ID to add classes in person at Admissions & Records.
- B. To Add a Closed Class:**
- To add the class, you must attend the first class meeting and obtain an ADD Authorization from the instructor.
  - You must have your Mt. SAC student schedule printout and a picture ID.**
  - You must be **eligible** (*have the appropriate prerequisite*) for the class. If the course has a required prerequisite, obtain a Proof of Eligibility Form from the appropriate Division Office or Admissions and Records prior to attending the class you wish to add.
  - If you receive an ADD Authorization Code from the instructor, add the class online.
  - Registration for all Added classes must be completed prior to the expiration date on the ADD Authorization Code.**

**ADD AUTHORIZATION CODES:** A 4 digit code is issued by the instructor of a closed class. You must enter the Course Reference Number (CRN) and the ADD Authorization Code when prompted at ***inside.mtsac.edu*** to add the closed class. ADD Authorization Codes can only be used once and have expiration dates. Be sure to use the code on or before the expiration date. Failure to use the codes prior to expiration will prevent students from adding the class.

**WAIT LISTS:** Wait lists will be available beginning the first day of registration.

### C. To Drop a Class:

- Drop classes online at ***inside.mtsac.edu***. Verify your drops by printing your schedule/receipt.
- See your Schedule/Receipt for important deadlines related to dropping classes.
- See page 21 for refund information.

# Course Policies

## Attendance

Students should check their Schedule for the day and time their classes meet and ALLOW PLENTY OF TIME TO PARK AND LOCATE THE CORRECT CLASSROOM.

Students who enroll in class must attend the first class meeting. Any student who has not arrived within the first 30 minutes of the first class meeting may be dropped from the class roster and the place given to a waiting student who was unable to enroll at the time of registration. Failure to attend the first class meeting does not ensure that you will be dropped. **It is the student's responsibility to drop a class.**

Success in college depends upon regular class attendance. Poor attendance can result in a low grade in a class. Instructors may drop a student who has excessive absences. It is each student's responsibility to know the attendance policies of each of his/her instructors.

**Students are responsible for dropping classes they do not plan to attend. Failure to drop will result in an "F" letter grade on a student's transcript.**

## Auditing

Students are not permitted to audit classes. All individuals attending, visiting, participating or sitting in the class must be officially registered in that particular class.

## Course Repetition

**Only certain courses may be repeated for credit.**

Refer to the latest Mt. SAC Catalog regarding the repeatability allowance for specific courses. If a course is repeatable, the course may only be repeated for the number of times indicated. Students are allowed to repeat a course in which they received a substandard grade/mark ("D," "F," "W," "NC," "NP") only two times (for a total of three attempts). Students attempting to enroll in the same course a fourth time will be blocked automatically from registering.

Courses for which satisfactory grades of "A," "B," "C," or "Pass" are received may not be repeated. Only upon extenuating circumstances will repetition in courses for which the student has satisfactorily passed be allowed. Students with extenuating circumstances may file a Petition for Exceptional Action form in the Admissions and Records Office. Students who repeat courses based on this provision will not earn additional units or grade points toward improving or changing the previous grade earned in the class or toward changing the overall grade point average.

## Dropping Courses and Withdrawing from the College

It is the students' responsibility to drop or withdraw from courses they no longer attend. Students should check their schedule/receipt, available on the "My Mt SAC" portal for information regarding key dates. Dates vary and are often course specific.

### Full 16-week courses

For 16 week courses, students who drop a class, withdraw

from the college, or are dropped from a class by the professor by the Sunday at the end of the second week of classes will not receive any mark or notation on their permanent academic record.

Students who drop a class, withdraw from the college, or are dropped by the professor beginning Monday of the third week of a 16 week class will receive a mark of "W" (Withdrawal) on their permanent record.

Professors may not drop students from a class and students may not drop themselves from any class or withdraw from the college after 60% of the class has elapsed. All students who are registered for a class after 60% of the class has elapsed shall receive an academic grade (A,B,C,D,F,P,NP) or an Incomplete mark for the class. A "W" Withdrawal mark shall not be assigned to any student enrolled after the last day to drop a class except in the case of an approved petition due to extenuating circumstances. A "W" Withdrawal remains a permanent part of a student's academic record.

### Intersessions and other short term classes

For short term classes, students who drop a class, withdraw from college or are dropped from a class by the professor prior to the conclusion of the first 20% of the class will not receive any mark or notation on their permanent record.

Students who drop a class, withdraw from the college, or are dropped by the professor after 20% of the class has elapsed will receive a mark of "W" (Withdrawal) on their permanent record.

Professors may not drop students from a class and students may not drop themselves from any class or withdraw from the college after 60% of the class has elapsed. All students who are registered for a class after 60% of the class has elapsed shall receive an academic grade (A,B,C,D,F,P,NP) or an Incomplete mark for the class. A "W" Withdrawal mark shall not be assigned to any student enrolled after the last day to drop a class except in the case of an approved petition due to extenuating circumstances. A "W" Withdrawal remains a permanent part of a student's academic record.

## Student Load Limits

Without petitioning, students may enroll in up to 18 units each semester and up to 7 units each summer and winter intersession. Students who have completed a minimum of 15 college units in a given semester with a grade point average of at least 3.0 and have a minimum cumulative grade point average of at least 3.0 may petition for permission to enroll in units above the maximum. Petitions for Exceptional Action are available in the Counseling Center, located on the upper level of the Student Services Center.

## Petition for Exceptional Action

Petition for Exceptional Action forms are available from the Counseling Center and Admissions and Records Office in the Student Services Center. Action on a petition will be taken either by the appropriate administrator or the Board of Appeals.

# Grades

## Final Grades

Final grades for the previous semester will be available online via ***inside.mtsac.edu*** beginning the third week of the following term.

- When you visit ***inside.mtsac.edu***, you will be directed to the appropriate screen to view your transcript.
- If you need a copy of your grades, you can obtain a student copy of your Mt. SAC transcript on your portal. You can request **official** transcripts online through ***inside.mtsac.edu*** student portal.

## Pass/No Pass Grades

Some classes offered at Mt. SAC are available with two different grading options: letter grade (A, B, C, D, F) or a Pass/No Pass (Pass: A, B, or C; No Pass: The equivalent of D or F).

A few classes are offered for Pass/No Pass only. These courses are designed to encourage students to explore areas outside their major field of study in order to broaden and enrich their collegiate experience, and to afford an opportunity for departments to offer courses in which there is diminished emphasis on grades. **The Pass/No Pass grading option is not available for General Education courses.**

In courses offering both grading options, students are automatically registered on a letter-grade basis at the time of registration. If a change is desired, students must declare their intent to be graded on a Pass/No Pass basis.

Credit toward graduation by using Pass/No Pass classes is limited to a maximum of sixteen units. Courses taken for Pass/No Pass are not counted in calculating the grade point average, or in determining eligibility for the Dean's List or President's List. However, these courses are considered in probation and dismissal procedures.

## Incomplete Grades

A faculty member may approve a petition for an Incomplete, "I," for work missed commencing with the 14th week of a regular semester (or after 85% of a short-term class) under the circumstances listed below:

- A. Verifiable serious illness or emergency
- B. Verifiable work conflict
- C. Call to active military duty

The requirements for removal of the "I" shall be stated by the instructor on the "Petition to Request Incomplete Grade" form. Approval of an incomplete and the assignment of a replacement grade are at the discretion of the instructor. If the "I" is not made up within one year of its issue, the predetermined replacement grade will be assigned. If a grade was not predetermined, the "I" will revert to an "F" **Students may not re-register in a class while an "I" is in effect for that class.**

# Fee Refund Policy

## Fee Refunds

Refunds are now automatic. In order to receive a refund, you must drop your class(es) by the refund deadline for that class. The deadline can be found on your Student Schedule/Receipt (see sample below). Classes that do not attain minimum initial enrollment may be cancelled. **Students who have dropped or cancelled classes will receive a refund through their refund preference selected with BankMobile (formerly Higher One).** Students will also be entitled to refunds for textbook(s) purchased if such textbook(s) have not been marked.

## Parking Permit Refund

To receive a refund for your current parking permit, you must return the permit to the Bursar's Office. This can be done in person, by mail or dropped off at the Bursar's Office drop box. The deadline is July 2, 2018. If you paid for your parking permit with a credit card, you will receive

a credit back to your card. If you paid by cash or check you will receive a refund through your refund preference selected with BankMobile.

## Production & Copy Cards Refunds

Production cards can be returned to the Bursar's Office for refund until July 2, 2018, if unmarked and unused.

## Refund for CCPG (formerly BOGW)

You may apply for a California College Promise Grant (CCPG) at any point within the academic year. If you qualify and have already paid, you will be automatically reimbursed for covered fees in the form of a refund through your refund preference selected with BankMobile.

### Mt. San Antonio College Student Schedule/Receipt Spring 2015

**SAMPLE**

Schedule for  
16-MAR-2015

Your Registration Begins: 15 JAN 2015 at 7:00am

#### Enrolled Courses

Crn	Subj	Crse	Title	Crd	Start Date	End Date	Times	Days	Bld	Rm
40973	ENGL	1A	Freshman Composition	4.0	23-FEB-15	14-JUN-15	12:00- 2:05pm	M W	26A	3620
41374	SPAN	1	Elementary Spanish	4.0	23-FEB-15	14-JUN-15	9:00- 1:15pm	F	66	248
41930	BIOL	21	Marine Biology Lab	1.0	23-FEB-15	14-JUN-15	9:45-12:55pm	T	7	1115
42098	KIN	34	Fitness for Living	3.0	23-FEB-15	14-JUN-15	9:45-11:10am	M W	45	1462
43074	BIOL	20	Marine Biology	3.0	23-FEB-15	14-JUN-15	1:15- 2:40pm	T R	11	2312
44211	BS	LANG1	Language Skills Laboratory	0.0	23-FEB-15	14-JUN-15	TBA		6	264

#### Additional Information

Crn	Subj	Crse	Instructor	Email	Refund Deadline	Last Day to Drop Without a W	Last Day to Drop With a W
40973	ENGL	1A	Boehner-Staylor, Maya C.	mstaylor@mtsac.edu	06-MAR-15	08-MAR-15	01-MAY-15
41374	SPAN	1	Baler, Pablo F.	pbaler@mtsac.edu	06-MAR-15	08-MAR-15	01-MAY-15
41930	BIOL	21	Schmidt, Sherry E.	sschmidt@mtsac.edu	06-MAR-15	08-MAR-15	01-MAY-15
42098	KIN	34	Sanchez, Juan C.	jsanchez@mtsac.edu	06-MAR-15	08-MAR-15	01-MAY-15
43074	BIOL	20	Bava, Jose	jbava@mtsac.edu	06-MAR-15	08-MAR-15	01-MAY-15
44211	BS	LANG1	Marcy, Peggy C.	pmarcy@mtsac.edu	12-JUN-15	12-JUN-15	12-JUN-15

#### Account Information

Any unpaid fees that result after the semester begins will be placed on a financial hold. Financial holds will prevent students from enrollment, transcripts, withdrawals and prohibit access to certain campus services.

It is the student's responsibility to drop classes by the appropriate deadline as shown above. Students who remain enrolled after the refund deadline are not eligible for a refund and remain financially responsible for payment of fees even if they drop the class or are dropped by their instructor.

Refunds are processed when classes are dropped by the course refund deadline date (see above). You will receive a refund through your preference on your MTSAC Card. See <http://myportal.mtsac.edu> for further information. For parking permit refund deadlines see the current [Schedule of Classes](#).

Account Summary for			
			Account Balance: \$0.00
Spring 2015			
Detail Code	Description	Charge	Payment Balance
ENRL	Enrollment	\$690.00	\$0.00
HTHF	Health Fee	\$19.00	\$0.00
SREP	Student Representation Fee	\$0.50	\$0.00
STAF	Student Activity Fee	\$11.00	\$0.00
VSA2	Visa (Web Credit Cards)		\$720.50
	Term Charges:	\$720.50	
	Term Credits:	\$720.50	
	Term Balance:		\$0.00
	Previous Balance:		\$0.00
	Account Balance:		\$0.00

# Student Services and Resources

*Please visit the website or call for current hours of operation*

## Accessibility Resources for Students (formerly known as DSPS)

**Ext. 4290**

**Bldg. 9B**

[www.mtsac.edu/access](http://www.mtsac.edu/access)

The Access Center provides services to students who have professionally documented disabilities and need additional services to successfully attend classes at Mt. SAC. Students who suspect they might have a disability are welcome to apply for services and an eligibility determination will be made. **Disability-related information about students is held in the strictest confidence.**

Based on individual disability-related needs, some of the services include specialized counseling, priority registration assistance, assessment of disability and educational needs, access to an adaptive computer lab, equipment loans, sign language interpreters, note takers in the classroom, classroom and testing accommodations, transportation around campus, and many other services and accommodations.

## ACES Program (Achieving in College, Ensuring Success)

**Ext. 4411**

**Bldg. 9E**

[www.mtsac.edu/aces](http://www.mtsac.edu/aces)

ACES (Achieving in College, Ensuring Success) is a TRiO Student Support Services Program that was established by Congress to help students overcome class, social, academic, and cultural barriers to higher education. The ACES Program is funded by a \$213,180 per year grant from the U.S. Department of Education. ACES is designed to assist students who are low-income and/or the first in their family to attend college and/or disabled to obtain an Associates Degree and transfer from Mt. San Antonio College to a four-year institution. ACES services focus on a holistic approach to student development and student success. Participants will gain the knowledge and skills necessary to achieve their educational goals and ultimately obtain a bachelor's degree.

## Admissions & Records

**Ext. 4415**

**Bldg. 9B**

[www.mtsac.edu/admissions](http://www.mtsac.edu/admissions)

The Admissions and Records office provides comprehensive admissions/registration services for all credit students, processes student requests for transcripts, enrollment verifications, general education (transfer) certifications, and graduation evaluations. Special services are provided for international (F-1 Visa) students. Assistance is available in English, Spanish, Vietnamese and Chinese.

## Aspire Program

**Ext. 6396**

**Bldg. 9F**

[www.mtsac.edu/aspire](http://www.mtsac.edu/aspire)

Aspire is a student success program designed to enrich the experience of African-Americans and other students at Mt. SAC through counseling, instruction, mentoring, and community building. Aspire's primary focus is to equip

you with resources to boost your academic performance and help you reach your goals at Mt. SAC. Aspire students perform better, because they learn how to get the most from their college experience. They have caring mentors who encourage and motivate them to achieve their personal potential. Aspire students bond together as a "community" by sharing experience and participating in college tours, success workshops, tutoring, and campus activities.

## Assessment Center

**Ext. 4265**

**Bldg. 9B**

[www.mtsac.edu/assessment](http://www.mtsac.edu/assessment)

All Mt. SAC students are required to participate in assessment for course placement. The assessment and placement process has been established to enable all students the opportunity to be successful in their coursework. Please go to your student portal and complete the Assessment Questionnaire. Upon completion, you will be given your course placement or will be advised on your next step in the assessment process.

## Bookstore (SacBookRac)

**Ext. 4475**

**Bldg. 9A**

[bookstore.mtsac.edu/](http://bookstore.mtsac.edu/)

Visit Bookstore website for current hours of operation and buyback hours and locations.

SacBookRac offers textbooks, school supplies, Mt. SAC apparel, gift items, and houses the Mt. SAC Photo ID area. Textbooks and supplies for students average between \$300 to \$600 per semester, depending upon the program of study selected. Students are encouraged to buy books early, especially to save money by purchasing used books. Books are sold on a first-come, first-served basis. Students may order textbooks online at [www.sacbookrac.com](http://www.sacbookrac.com). Orders can be picked up at the store or shipped to the student's home.

## Refund Policy

Refunds are allowed within the first week of the start of each semester. The refund policy details are posted in the bookstore and are printed on a bookmark which is attached to the purchase receipt.

## Bridge Program

**Ext. 5392**

**Bldg. 9E**

[www.mtsac.edu/bridge](http://www.mtsac.edu/bridge)

The Bridge Program offers several learning communities designed to increase students' academic and personal success through the structuring of the learning environment. Students participating in a learning community are enrolled in linked or clustered classes that are taught in a cooperative environment between instructors. There are various learning communities offered: Summer Bridge, Math Bridge, English Bridge and many more. Each learning community focuses on a specific academic need and has an assigned counselor to assist students. The Bridge Program is perfect for students who are the first in their family to attend college, want to improve academic and social skills, want to learn more about career and transfer options, or need additional support during their first year at Mt. SAC.



# Student Services and Resources

*Please visit the website or call for current hours of operation*

## **Bursar's Office**

**Ext. 4960**

**Bldg. 4, Lower Level**

[www.mtsac.edu/bursars](http://www.mtsac.edu/bursars)

The Bursar's Office manages the collection of credit registration fees and other campus fees including parking permits, replacements, parking citation fees, enrollment verification, and production cards. The office also processes refunds for credit classes, parking permits and production cards.

## **CalWORKs (California Work Opportunity and Responsibility to Kids)**

**Ext. 4755**

**Bldg. 9B**

[www.mtsac.edu/calworks](http://www.mtsac.edu/calworks)

The CalWORKs program provides services to Mt. SAC students who are recipients of TANF/CalWORKs cash-aid for themselves and their children. The CalWORKs program serves as the liaison between the student and their county office. Support services include: educational planning, case management, job development/placement assistance, referrals to the basic skills tutoring/computer skills lab and the GED/High School diploma programs. Based upon available funding, childcare and work-study may be available. The CalWORKs program also provides support in complying with the 32/35 hours per week welfare-to-work requirement.

## **Career and Transfer Services**

**Bldg. 9B**

[careerservices.mtsac.edu](http://careerservices.mtsac.edu)

[transfer.mtsac.edu](http://transfer.mtsac.edu)

Career and Transfer Services helps students transition to their next goal of employment and/or transfer. We provide a variety of services, activities, events and resources to help students solidify career goals, sharpen job acquisition skills, acquire part- and full-time employment, and transfer to universities.

### **CAREER SERVICES**

**Ext. 4510**

Activities, resources and events include:

- Job and internship referrals
- Career fairs
- Career acquisition skills workshops
- Mock interview sessions
- 1-on-1 assistance with résumé preparation, interviewing techniques, and general job search

### **TRANSFER SERVICES**

**Ext. 6388**

Activities, resources and events include:

- Career and college guidebooks and university catalogs library
- Workshops on career and transfer topics
- University representative visits and appointments
- College fairs
- University tours
- Walk-in transfer advising
- Computers for career and transfer research, applications and more!

## **Child Development Center (Childcare Services)**

**Ext. 4920**

**Bldgs. 70-73**

[www.mtsac.edu/cdc](http://www.mtsac.edu/cdc)

### **Admission Policy**

Early care and education services are provided Monday through Friday for student-parents, staff/faculty, and community members. The Child Development Center welcomes children from 3 months through 5 years regardless of sex, ethnicity, or physical disability. A child must be in overall good health in order to attend. Parents seeking tuition assistance must meet income requirements and demonstrate a need for care with (one or a combination of) acceptable and verifiable activities: 6 or more units of credit courses, employment, work-study, job training programs, non-credit courses directly related to employment, etc.

### **Tuition Assistance and Payment Options**

Half and full-day State Preschool programs, General Childcare, and CCAMPIS (Pell Grant) funding are available for eligible families. We also welcome CalWORKs and other alternative payment programs. Families not eligible for these funding sources may enroll in the tuition-based program. For information on tuition rates, contact the Center at (909) 274-4920.

### **Minimum Hours Requirements**

Children must enroll a minimum of 20 hours per week.

### **Enrollment**

Application and registration must be done in person at the Child Development Center. For more information, contact the Center at (909) 274-4920 or visit the website.

## **Counseling Center**

**Ext. 4380**

**Bldg. 9B**

[www.mtsac.edu/counseling](http://www.mtsac.edu/counseling)

Students can take advantage of educational planning, career exploration and decision-making, and other services offered through the Counseling Center on the second floor of the Student Services Center.

Counselors are available to assist students who:

- are undecided about their major or career direction;
- need information about their career and transfer options;
- are having difficulty in their courses;
- need assistance with personal problems.

**It is highly recommended that students see a counselor during their first semester at Mt. SAC to develop a student educational plan.**

Counselors and educational advisors can also provide:

- information on course selection and planning for degree or certificate completion;
- information about major and transfer requirements to CSU, UC and private universities;
- general information about the college.

# Student Services and Resources

*Please visit the website or call for current hours of operation*

## **DREAM Program**

**Ext. 5596**

**Bldg. 16C**

<http://www.mtsac.edu/dream/>

The DREAM Program is part of the campus wide Student Equity (SE) efforts designed to provide support services for the success of Dreamers/Undocumented students at Mt. San Antonio College (Mt. SAC). Its purpose is to provide the space where Dream students can come together to receive the support they need to succeed in college. The program strives to increase the personal growth and development of Dreamer students through academic, career and personal counseling, which is provided by a full-time faculty counselor, who brings extensive background and knowledge on how to guide and support Dreamers. Peer mentoring as well as educational workshops are available for students to encourage engagement and participation outside the classroom experience. Moreover, tutoring is also available to ensure the academic success of program participants. The DREAM Program provides assistance in applying for the California Dream Act/Financial Aid and scholarship opportunities. Additionally, through its partnerships, the DREAM Program has a referral process to assist students in applying for DACA and/or Medical Services as well as other services relative to this student population. By using a holistic approach the DREAM Program strives to help students navigate the higher educational system and beyond.

## **Extended Opportunity Programs and Services (EOPS) and Cooperative Agencies Resources for Education (CARE)**

**Ext. 4500**

**Bldg. 9B**

[www.mtsac.edu/eops](http://www.mtsac.edu/eops) [www.mtsac.edu/eops/care.html](http://www.mtsac.edu/eops/care.html)

EOPS provides support services to students with academic and financial disadvantages. Services include counseling, educational planning, peer advising, tutoring, book services, and priority registration. Mt. SAC's CARE program is designed to recruit and assist single parents who are heads of household with children 13 years old and under and who are TANF/CALWORKs cash aid recipients attending community college. To meet eligibility requirements for CARE, either the student or dependent child must receive cash aid. CARE students receive additional support through counseling, tutoring, assistance with books and supplies, and grants.

## **Financial Aid and Scholarships**

**Ext. 4450**

**Bldg. 9B**

[www.mtsac.edu/financialaid](http://www.mtsac.edu/financialaid)  
[www.mtsac.edu/scholarships](http://www.mtsac.edu/scholarships)

The Financial Aid Office provides assistance in applying for state and federal financial assistance, including grants, loans, scholarships, fee waivers and work study. Students must complete the FAFSA (Free Application for Federal Student Aid) form. The College's priority filing date is April 15 of each year for the following academic year. Information and applications for scholarships are also available throughout the year in the Financial Aid Office.

## **Food Services**

[www.mtsacdining.com](http://www.mtsacdining.com)

The Food Services Department provides the campus community with a cafeteria, coffeehouse, and four convenience stores.

### **Mountie Cafe**

**Bldg. 8, Ext. 5284**

Located on the west side of campus next to SacBookRac, Mountie Cafe is the perfect meeting spot. Students will find diverse food options including:

- *Common Grounds featuring Starbucks* - we proudly brew hot and cold coffee drinks, frappuccino, fresh baked muffins, scones, and brownies..
- *SubConnection* - fresh, made-to-order deli sandwiches, salads or wraps
- *Original Burger Company Grill* - OBC serves custom certified angus beef burgers, veggie burgers and grilled chicken sandwiches
- *Pandinis* - individual pizzas, signature Labretti sandwiches, fresh salads and tossed pasta
- *Mein Bowl* - specializing in Chinese favorites, pick from entrees and your choice of noodles, rice or fried rice

### **WOW at Mountie Grill**

**Bldg. 19C, Ext. 4624**

WOW Cafe and Wingery - breakfast, wings, chicken, hamburgers, salads and rice bowls.

### **Convenience Stores**

All stores offer a variety of snack foods, beverages and school and test supplies.

### **Mountie Stop**

Building 9A

### **Express Stop**

Building 16A

### **Prime Stop**

Building 61

### **Short Stop**

Building 66

### **Vending Machines**

Buildings 2, 3, 9C, 23, 26, 28, 30, 31, 40, 45, 47, 50G, 60, 67, 80

*If students have a problem getting food or money returned, they may go the Fiscal Services Office window located on the first floor of Bldg. 4 to complete a form and receive a refund.*

## **High School Outreach**

**Ext. 5906**

**Bldg. 9B**

[www.mtsac.edu/hso](http://www.mtsac.edu/hso)

This office coordinates the College's outreach efforts to area high schools. Staff provide regular visitations and specialized presentations to high school students, parents, and high school staff. Matriculation information and assistance are provided to high school students interested in enrolling as new freshmen.

# Student Services and Resources

Please visit the website or call for current hours of operation

## The Honors Program

Ext. 4665 Bldg. 26A, Room 1680

[www.mtsac.edu/honors](http://www.mtsac.edu/honors)

Mt. SAC offers an Honors Program for students who have demonstrated academic excellence either in high school or in college. Students in the program take honors-designated courses which are transferable and, with a few exceptions, are part of the IGETC requirement list. Completion of Honors Certification makes a student eligible for priority admission consideration from many universities including UCLA, UC Irvine, Chapman University, Pitzer College and Pomona College. In addition to an enhanced curriculum for motivated students, Honors Program students may receive library privileges at UC Irvine and UCLA and an Honors certificate and medallion upon honors certification and either graduation or transfer.

### Entrance Requirements

Graduating High School Students:

- Eligibility for ENGL 1A
- 3.2 unweighted GPA
- Letter of recommendation
- Short essay

Mt. San Antonio College Students:

- Completion of 9 transferable units
- Eligibility for ENGL 1A
- 3.2 transferable GPA
- Short essay
- Letter of recommendation (Waived if transferable GPA is 3.5 or higher)

### Requirements for Completion of "Honors Scholar" Certification and Designation

- Completion of 15 units of honors courses with a minimum 3.2 transferable GPA
- Maintain a 3.2 transferable cumulative GPA

## International Student Center

Ext. 5032 Bldg. 9B

[www.mtsac.edu/international](http://www.mtsac.edu/international)

The International Student Center is available for international students to obtain information regarding services and resources, register for workshops and field trips, meet with study groups or use the computer lab.

## The Language Learning Center

Ext. 4580 Bldg. 6-264

[www.mtsac.edu/instruction/continuinged/noncredit/esl/learning\\_resources/language\\_learning\\_center.html](http://www.mtsac.edu/instruction/continuinged/noncredit/esl/learning_resources/language_learning_center.html)

Provides media and technology to practice foreign languages and English.

## Learning Lab, Learning Technology Center, Bldg. 6, South Entrance, First Floor

Ext. 5666

[www.mtsac.edu/instruction/learning/lac/services.html](http://www.mtsac.edu/instruction/learning/lac/services.html)

The Learning Lab offers free use of PC and MAC computers which have access to the Mt. SAC Library databases, internet, word-processing, spreadsheets, and a variety

of course-related software. Registration for the Lab is necessary upon first time use per semester. Students are required to present a current Mt. SAC student photo I.D. at the front desk to access the Lab. Laser printing is available for a fee. A print card dispenser is located in the lab for student convenience. Technical and academic assistance are available for students who need help using a computer or a specific program, setting up access to the student portal, and using databases for research. Workshops are offered on appointment basis to assist students who want more instruction on word-processing, E-mail, database/web research, PowerPoint and course-related materials.

## Library, Learning Technology Center, Bldg. 6, North Entrance

Ext. 4260

<http://library.mtsac.edu>

The Library offers students, faculty, and staff a place to develop information and technology literacy, cultivate information inquiry skills, engage in quiet study, and meet to collaborate with fellow students. A Mt. SAC ID is needed to use reserve materials such as textbooks in the library and take other library materials out of the library.

## Parking Services

Ext. 4233

Bldg. 23

[www.mtsac.edu/safety](http://www.mtsac.edu/safety)

Closed holidays and evening hours during recesses

## REACH Program (Foster Youth)

Bldg 9B, 2nd Floor, Room 201

[www.mtsac.edu/reach.html](http://www.mtsac.edu/reach.html)

REACH is an educational program designed to assist current and former Foster youth. REACH provides assistance and support to our FosterYouth students in their transition into college, while attending Mt. SAC and as they transfer to a University. We, the REACH program, are committed to be a partner of our FosterYouth students and walk with them side by side in their educational endeavor. Some REACH services offered are mentoring and support, housing resources, priority registration, AB12 (extended foster care) resources, Chafee grant assistance, and much more! Additional information can be found at: [www.mtsac.edu/reach.html](http://www.mtsac.edu/reach.html).

## Student Health Services

Ext. 4400

Bldg. 67B

[www.mtsac.edu/healthcenter](http://www.mtsac.edu/healthcenter)

Medical, chiropractic, personal counseling, nursing, and health education services are provided. Additional services include laboratory tests, tuberculosis screening, limited prescription medications, immunizations, pregnancy testing, and referrals. All credit students who are currently enrolled and attending classes are eligible. Part-time faculty are eligible for select services. Some fees may apply. Professional health services are provided primarily on an appointment basis. Same-day appointments are also available; call between 8:00 and 8:30 a.m. First aid services are provided for all students, employees and guests of the College.

# Student Services and Resources

*Please visit the website or call for current hours of operation*

## **Student Life/Student Activities/ Student Life Center**

**Ext. 4525**

**Bldg. 9C**

[www.mtsac.edu/studentlife](http://www.mtsac.edu/studentlife)

The Student Life Office is responsible for student involvement and leadership programs and serves as the hub of student activities at Mt. SAC. The Associated Students (AS) Government serves as the representative voice for students, while providing students with an opportunity to develop leadership skills. The Student Activities Fee funds many AS activities, sponsored events, and initiatives which support student programs, projects and services throughout the year. Inter-Club Council represents over 45 student clubs and is comprised of one representative from each student club. The Student Life Center provides students a relaxing area to access free wireless internet with their laptops, watch TV, play foosball, ping pong, a variety of board games and video games. Students who are involved in co-curricular activities are encouraged to complete the Activities Transcript (available online) which complements their academic transcript and verifies their leadership and service experiences. The Bookstore Office (Bldg. 9A) sells AS discount amusement park and movie tickets. Student Life also oversees an off-campus Housing Referral Program and Lost and Found. All unclaimed items from the previous year are auctioned each September. Students' rights and due process procedures related to student discipline and academic grievances are facilitated through this office.

### **Tutoring**

Mt. SAC offers free tutoring for students in Math, English/Writing and many other subjects.

**Learning Assistance Center (LAC), Learning Technology Center, Bldg. 6, South Entrance, First Floor  
Ext. 4300**

<http://lac.mtsac.edu>

The Learning Assistance Center (LAC) offers tutoring, a computer lab, courses in basic Math, Reading, Writing, and study techniques, and testing services for make-up exams. Current Mt. SAC photo I.D. required.

**Math Activities Resource Centers, Math Activities Resource Center (MARC), Bldg. 61 — Room 1318  
Ext. 5014**

**Transfer Math Activities Resource Center (T-MARC), Bldg. 61 — Room 1314  
Ext. 5389**

[www.mtsac.edu/marc](http://www.mtsac.edu/marc)

The Math Activities Resource Center (MARC) and Transfer Math Activities Resource Center (T-MARC) offer services including free tutoring, study spaces, tutorial software, calculator rentals, textbooks, solution manuals, and handouts. The MARC serves students in Math 50 to Math 71. The T-MARC serves students in Math 100 and above.

### **Tech Ed Resource Center (TERC)**

**Building 18C, (909) 274-6118 or (909) 274-6122**

The Tech Ed Resource Center (TERC) offers basic math, text book reading, writing, and research methods assistance to

all CTE students. Students are encouraged to drop in and work with instructors or study independently. For additional information, please contact TERC at (909) 274-6121 or (909) 274-6122.

**Tutorial Services: Multiple Subjects, Learning Technology Center, Bldg. 6, South Entrance, First Floor  
Ext. 6605**

<http://lac.mtsac.edu>

Tutorial Services offers one-on-one tutoring in multiple subjects, either drop-in or by appointment, as well as study groups and supplemental instruction.

**The Writing Center, Bldg. 26B, Room 1561A  
Ext. 5325**

[www.mtsac.edu/writingcenter](http://www.mtsac.edu/writingcenter)

The Writing Center offers free tutoring, workshops, Directed Learning Activities (DLAs) and a computer lab for all students who would like help with writing. Students need to bring a current Mt. SAC ID to access services.

### **Upward Bound-TRiO**

**Ext. 4411**

**Bldg. 9E**

Upward Bound is a TRiO program that was established by Congress to help students overcome class, social, academic, and cultural barriers to higher education. The Upward Bound Program is funded by a \$237,438 per year grant from the U.S. Department of Education. Upward Bound is designed to assist high school students from La Puente High School and Ganesha High School who are low-income and/or the first in their family to attend college to pursue and obtain an education at an institution of higher learning. Upward Bound services place emphasis on the development of personal and academic self-confidence through the creation activities during the high school academic year and the summer dual enrollment program. Through Saturday academies, academic tutoring, college trips, Summer Program and other programming participants gain the knowledge and skills necessary to achieve their educational goals and ultimately obtain a bachelor's degree. Alumni and those interested in supporting Upward Bound are welcomed to do so at any time.

### **Veterans Resource Center**

**Ext. 4520**

**Bldg. 9E**

[www.mtsac.edu/veterans/](http://www.mtsac.edu/veterans/)

The Mt. SAC Veterans Resource Center (VRC) offers a wide range of services and programs to support our student Veterans and/or eligible dependents as they navigate the college environment. VRC services include: Vet-to-Vet peer mentoring in the Veterans Lounge; Free tutoring; Access to computer stations/lab; Laptop Rental Program; Emergency Book Loan Program; Book Loan/Reserve Program; FAFSA assistance; Scholarship research/essay assistance; DSP&S Instructional Specialist; Educational/Career counseling; One-on-one VA Educational Benefits assistance; Federal Department of Veterans Affairs Counseling; and on and off-campus service referrals. By offering a "one-stop shop" model, Veterans and their families are able to access assistance and referrals to essential services in a timely manner. For step-by-step instructions in claiming and utilizing educational benefits at Mt. SAC, Veterans and dependents should download the "Veterans Packet" at <http://www.mtsac.edu/veterans/applyforbenefits.html>.

## Campus Safety

Services available to help assure your safety include:

- **Police & Campus Safe Escorts** are available to escort you during evening hours, to assure your safety on campus and in parking lots. They are provided at your request, Monday – Thursday, 6:30 p.m. – 10:15 p.m. Police & Campus Safety Escorts can be identified by their yellow shirts and/or jackets and I.D. badges. Please call ext. 4555 or (909) 274-4555 to arrange for assistance.
- **Blue emergency telephone towers** are located throughout the campus and parking lots for you to contact Police & Campus Safety immediately should you need assistance in an emergency.
- **Police & Campus Safety** may be contacted by calling the campus number, (909) 274-4555.
- Call 911 for any emergency or 9-911 when calling from on-campus extensions. Be prepared to identify your exact location.

In addition to contacting the Police & Campus Safety Department, information can also be obtained from the Student Life Office, Bldg. 9C, ext. 4525 or at <http://inside.mtsac.edu>

## Campus Emergency Notification System

As part of our continuing effort to provide a safe environment for students and employees, Mt. San Antonio College has a campus-wide emergency notification system. This system enables authorized college personnel to quickly notify students, faculty, and staff about any campus emergency with personalized voice, text and e-mail messages.

In order to execute the process effectively, we need your current contact information and your preferred method of notification. You are able to provide your information on a secured online site at [inside.mtsac.edu](http://inside.mtsac.edu). Look for the Campus Emergency Notification add/update link. Be assured that your privacy will be protected. Your information will not be shared with anyone or used for any purpose other than for emergency notifications.

## Campus Emergency Phone System

Mt. SAC has installed a campus-wide emergency phone system. This system is divided into two primary segments. The inner campus system consists of emergency phones that are placed on the outside of selected campus buildings and are identified by the familiar blue light affixed to the top of the phone housing.

The second segment of emergency phones consists of stand-alone emergency phone towers, located in open campus spaces, primarily in campus parking lots. These phone towers are also identified by a blue light affixed to the top of the tower. Use of any of these emergency phones will connect the user to Police & Campus Safety Department during normal business hours, located in Building 23. During hours when the campus is closed, the emergency phones will connect the user directly to a cell phone carried by Police & Campus Safety Officers who are on duty 24 hours a day, 7 days a week.

## Crime Prevention

The Police & Campus Safety Department's primary responsibility is the safety and security of all members of the College community. Every effort is made to inform students and staff of criminal activity or any other concern that may be an immediate threat to the safety and security of those on campus. Information and workshops on crime prevention are made available to College students and staff. It is the responsibility of every member of the campus community to act in ways that promote the safety of self and others and that protect District property.

## Police & Campus Safety Enforcement Authority

The Mt. San Antonio College Police & Campus Safety Department has the authority to enforce the Student Discipline Code of Conduct and the State of California Penal Code under Education Code Section 72330. The Mt. San Antonio College Board of Trustees has established the Police & Campus Safety Department as a community college police department under Education Code Section 72330 (a), which authorizes the governing board of a community college district to establish a community college police department under the supervision of a community college chief of police. Although a designated police department, the Mt. San Antonio College Police & Campus Safety Department has a memorandum of understanding mandated by the "Crime Awareness and Campus Safety Act of 1990," that the Los Angeles County Sheriff's Department has jurisdiction to investigate all crimes occurring on Mt. San Antonio College Campus.

# Campus Safety

## Annual Security Report

In compliance with the Clery Act, the College publishes an annual security report which contains information regarding campus crime statistics. This information may be found on the website below. Copies of the annual report can be obtained from the Police & Campus Safety Department, Building 23. The Police & Campus Safety Crime Log is maintained in the Department of Police & Campus Safety office. Brochures on Emergency Procedures are available throughout the campus.

<http://www.mtsac.edu/safety/pdf/2015-Annual-Security-Report-final.pdf>

## POLICE & CAMPUS SAFETY DEPARTMENT STATISTICAL CRIME REPORT YTD TOTALS

VIOLATION	2013	2014	2015
Robbery	0	0	1
Aggravated Assault	2	1	1
Burglary	14	12	10
Motor Vehicle Theft (GTA)	12	5	4
Arson	1	0	0
Dating Violence	NR	0	0
Domestic Violence	NR	2	0
Stalking	NR	0	1

\*NR means the statistic was not required by the Clery Act in a particular year.

## Reporting Crimes & Emergencies

Students and staff should report serious crimes and emergencies, i.e., fire/medical, occurring on campus to the Police & Campus Safety Department or call **911**. When using an on-campus extension, call 9-911. Incidents may be reported to Police & Campus Safety by calling **(909) 274-4555**, 24 hours a day, seven days a week. Police & Campus Safety may also be contacted during and after business hours from public telephone locations on campus by dialing **\*-91**. In the event of an emergency, students and staff are requested to make a prompt and accurate report to the Police & Campus Safety Department. The Police & Campus Safety Department is located at the southeast portion of the campus off Bonita Drive in Building 23.

# 2018 SUMMER SCHEDULE of CLASSES

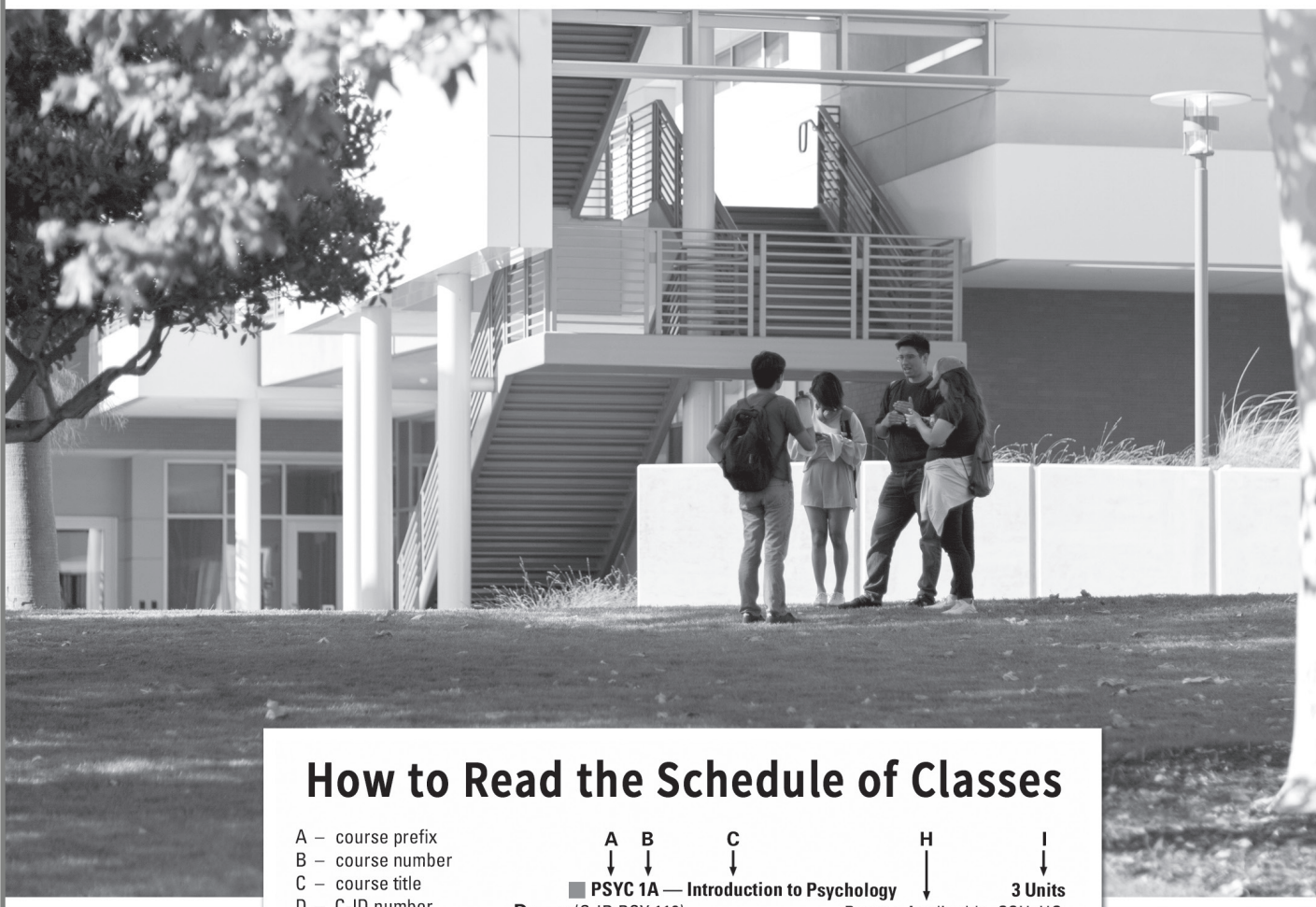

## How to Read the Schedule of Classes

- A – course prefix
- B – course number
- C – course title
- D – C-ID number
- E – prerequisite
- F – advisory
- G – course description
- H – transfer code
- I – number of units
- J – course reference number (CRN)
- K – days class meets
- L – time class meets
- M – name of professor
- N – building number
- O – room number

A ↓
B ↓
C ↓
H ↓
I ↓

D →
PSYC 1A — Introduction to Psychology
3 Units

(C-ID PSY 110)
Degree Applicable, CSU, UC

E → Prerequisite: Eligibility for ENGL 1A

F → Advisory: Eligibility for READ 100 or completion of AMLA 33R

G → Psychological approaches to the study of behavior and mental processes.

20516	TTh	9:45am - 11:10am	Bacigalupi, S	26A-2811
↑	↑	↑	↑	↑
J	K	L	M	N O

Note: 12:00 p.m. is Noon

# Course Offerings

## June 21 - August 1

Administration of Justice: Law Enforcement .....	33	German .....	54
Aeronautics .....	33	History .....	54
Agriculture: Animal Health Technology .....	33	Histotechnology.....	56
Agriculture: Animal Science General .....	33	Honors Program.....	56
Agriculture: General Subjects.....	34	Honors Program Application .....	55
Agriculture: Ornamental Horticulture .....	34	Hospitality and Restaurant Management .....	56
Air Conditioning and Refrigeration.....	34	Interior Design .....	57
Aircraft Maintenance Technology .....	35	Italian .....	57
Alcohol Drug Counseling .....	35	Japanese .....	57
American Language.....	35	Journalism.....	58
Anatomy and Physiology .....	35	Kinesiology: Aquatics .....	58
Anthropology .....	36	Kinesiology: Athletics.....	58
Arabic.....	36	Kinesiology: Fitness.....	58
Architectural Technology .....	36	Kinesiology: Individual .....	60
Art: Animation.....	36	Kinesiology: Team Sport.....	60
Art: Basic Studio Arts .....	37	Kinesiology: Theory .....	60
Art: Graphic Design and Illustration .....	37	Learning Assistance.....	61
Art: Three-Dimensional Studio Arts .....	37	Learning Communities.....	61
Art: Two-Dimensional Studio Arts .....	37	Manufacturing Technology .....	62
Art History .....	38	Mathematics .....	62
Astronomy.....	38	Mathematics Course Sequence .....	63
Biology.....	38	Medical Terminology.....	64
Business: Accounting .....	39	Mental Health/Psychiatric Technician .....	64
Business: Business Communications .....	40	Microbiology .....	64
Business: Economics.....	40	Music .....	64
Business: Law .....	40	Nursing .....	66
Business: Management.....	41	Nutrition and Food .....	66
Business: Real Estate .....	41	Oceanography.....	66
Chemistry .....	42	Paralegal .....	66
Child Development.....	42	Philosophy.....	67
Chinese.....	43	Photography.....	69
Computer Information Systems: Beginning.....	43	Physics.....	69
Computer Information Systems: Programming .....	45	Political Science.....	70
Computer Science .....	45	Psychology .....	70
Computer and Networking Technology .....	45	Public Health .....	72
Counseling .....	45	Radio - Television .....	72
Dance: Activity .....	46	Radiologic Technology.....	73
Dance: Theory.....	47	Reading.....	73
Disabled Students .....	47	Reading Course Sequence.....	51, 73
Emergency Medical Service.....	47	Respiratory Therapy.....	74
Engineering .....	48	Sign Language, Interpreting .....	74
Engineering Design Technology.....	48	Sociology.....	74
English: Composition .....	48	Spanish.....	77
English Course Sequence:		Speech .....	77
If English Is Your Primary Language.....	49	Study Techniques.....	77
English Course Sequences:		Technology-Related Courses .....	78
If English Is Not Your Primary Language .....	50	Theater Arts.....	78
English: Literature.....	51	Welding .....	79
Family and Consumer Sciences .....	52		
Fashion Merchandising and Design.....	52	Distance Learning Program .....	80
Fire Technology .....	52	Distance Learning Program: Online Courses .....	80
French .....	52	Distance Learning Program:	
Geography.....	53	Online-Supported (Hybrid) Courses.....	81
Geology .....	53	Short-Term Credit Classes .....	81



# 2018 Summer Schedule of Classes

## ADMINISTRATION OF JUSTICE: LAW ENFORCEMENT

■ **ADJU 1 — The Administration of Justice System** **3.0 Units**  
(C-ID AJ 110) Degree Applicable, CSU, UC

History and philosophy of the justice system, subsystems, roles, relationships and theories of crime causation and correction.

**10023 MTW 7:30pm - 10:20pm Yagoda, M 28B-204**  
10031 arrange 9 hours Jefferson, P ONLINE

**NOTE: CRN 10559** is a Distance Learning Online Class.

**How to Begin Course:** Log into Canvas through <http://myportal.mtsac.edu> and click on CRN for your DL course. **NOTE:** Some courses may not be activated until the start of the term. If you cannot locate your DL course in Canvas when the term starts, contact the professor.

**Professor contact info:** Email Professor Jefferson at either: [pjefferson@mtsac.edu](mailto:pjefferson@mtsac.edu), through Student Detail Schedule or Canvas at MyMtSAC Portal.

**Students must use their Mt. SAC e-mail account and be aware of course commitment and student expectations described at <http://www.mtsac.edu/instruction/learning/distlearn/>**

**This class is part of the Online Education Initiative, which has lots of resources to enhance your learning in an online class. Students are expected to complete the Quest Program before the first day of class <http://www.mtsac.edu/distlearning/oei-quest.html>**

■ **ADJU 4 — Legal Aspects of Evidence** **3.0 Units**  
(C-ID AJ 124) Degree Applicable, CSU

Criminal evidence: admissibility, privileged communication, hearsay, and collection and preservation of evidence.

**10032 arrange 9 hours Heard, L ONLINE**

**NOTE: CRN 10560** is a Distance Learning Online Class.  
**How to Begin Course:** Log into Canvas through <http://myportal.mtsac.edu> and click on CRN for your DL course. **NOTE:** Some courses may not be activated until the start of the term. If you cannot locate your DL course in Canvas when the term starts, contact the professor.

**Professor contact info:** Email Professor Heard at either: [lheard@mtsac.edu](mailto:lheard@mtsac.edu), through Student Detail Schedule or Canvas at MyMtSAC Portal.

**Students must use their Mt. SAC e-mail account and be aware of course commitment and student expectations described at <http://www.mtsac.edu/instruction/learning/distlearn/>**

## AERONAUTICS

■ **AERO 254 — Aircraft Dispatcher Operations** **4.0 Units**  
Not Degree Applicable

*Prerequisite: AERO 100, and AERO 102, and AERO 104, and AERO 150, and AERO 152, and AERO 200, and AERO 202, and AERO 250, and AERO 252*

Elements and techniques of aircraft dispatch operations. Includes aircraft dispatcher briefings to a simulated flight crew.

**10041 MTWTh 10:15am - 11:40am Fleming, J 28B-103**  
and **MTWTh 11:50am - 1:15pm Shackelford, S 28B-103**  
**8 Weeks, Week beginning 06/21/2018 ending 08/19/2018**

## AGRICULTURE: ANIMAL HEALTH TECHNOLOGY

■ **AGHE 83A — Work Experience in Animal Health** **1.0 Unit**  
Degree Applicable, CSU

(May be taken for Pass/No Pass Only)

*Prerequisite: AGAN 51 and Compliance with Work Experience regulations as designated in the College Catalog*

**10490 arrange 12.5 hours Padilla, M 80-2301B**

**NOTE: CRN 10490 above** requires student to attend orientation on June 5, 2018 from 2:45-3:45 in building 80-1451 to obtain required paperwork for the course. Students that fail to attend orientation may be in jeopardy of losing their seat in the class. Work Experience packets will be issued and students will be confirmed for the course at that time. A minimum of 60 unpaid/75 paid hours of work required per credit. For questions regarding orientation, please contact Arnita Champion at 909-274-6080 or via email at [achampion@mtsac.edu](mailto:achampion@mtsac.edu)

**10491 arrange 12.5 hours Waters, D 80-2301E**

**NOTE: CRN 10491 above** requires student to attend orientation on June 5, 2018 from 2:45-3:45 in building 80-1451 to obtain required paperwork for the course. Students that fail to attend orientation may be in jeopardy of losing their seat in the class. Work Experience packets will be issued and students will be confirmed for the course at that time. A minimum of 60 unpaid/75 paid hours of work required per credit. For questions regarding orientation, please contact Arnita Champion at 909-274-6080 or via email at [achampion@mtsac.edu](mailto:achampion@mtsac.edu)

**10532 arrange 12.5 hours STAFF 80-2301E**

**NOTE: CRN 10532 above** requires student to attend orientation on June 5, 2018 from 2:45-3:45 in building 80-1451 to obtain required paperwork for the course. Students that fail to attend orientation may be in jeopardy of losing their seat in the class. Work Experience packets will be issued and students will be confirmed for the course at that time. A minimum of 60 unpaid/75 paid hours of work required per credit. For questions regarding orientation, please contact Arnita Champion at 909-274-6080 or via email at [achampion@mtsac.edu](mailto:achampion@mtsac.edu)

■ **AGHE 85 — Seminar in Registered Veterinary Technology** **1.0 Unit**  
Degree Applicable

*Prerequisite: AGHE 60 and completion of the Registered Veterinary Technology program.*

Prepares students for national and state veterinary technician registration examinations.

**10492 M 1:30pm - 4:20pm Vale, D 80-1451**

## AGRICULTURE: ANIMAL SCIENCE GENERAL

■ **AGAN 1 — Animal Science** **3.0 Units**  
Degree Applicable, CSU, UC

A scientific approach to the livestock industry. Field trips may be required.

**10496 MTW 8:30am - 11:20am Pepper, S 80-1431**

■ **AGAN 2 — Animal Nutrition** **3.0 Units**  
Degree Applicable, CSU, UC

**10786 TWTh 8:30am - 11:20am Hoffman, A 80-1220**

**10523 MTW 11:30am - 2:40pm Pepper, S 80-1431**

■ **AGAN 51 — Animal Handling and Restraint** **3.0 Units**  
Degree Applicable, CSU

Method of handling for large and small animals, including chemical and physical techniques of restraint. Field trip required.

10525 MTW 8:30am - 10:20am Barnes, N 80-1451  
and MTW 10:30am - 1:20pm Barnes, N 80-1451

■ **AGAN 94 — Animal Breeding** **3.0 Units**  
Degree Applicable

10520 TWTh 11:30am - 2:20pm Hoffman, A 80-1220

### AGRICULTURE: GENERAL SUBJECTS

■ **AGAG 59 — Work Experience in Agriculture** **1.0 Unit**  
Degree Applicable

(May be taken for Pass/No Pass Only)

*Prerequisite: Compliance with Work Experience regulations as designated in the College Catalog*

10533 arrange 12.5 hours Pepper, S F6C

**NOTE: CRN 10533 above** requires student to attend orientation on June 19, 2018 from 1pm to 2:30pm in building 80-1431 to obtain required paperwork for the course. Students that fail to attend orientation may be in jeopardy of losing their seat in the class. Work Experience packets will be issued and students will be confirmed for the course at that time. Students must complete 1/3 of the program units in the major before registering for work experience or concurrently enrolled in a SAM-C course. A minimum of 60 unpaid/75 paid hours of work required per credit. For questions regarding orientation, please contact Arnita Champion at 909-274-6080 or via email at achampion@mtsac.edu

### AGRICULTURE: ORNAMENTAL HORTICULTURE

■ **AGOR 91 — Work Experience in Horticulture** **1.0 Unit**  
Degree Applicable

(May be taken for Pass/No Pass Only)

*Prerequisite: Three units of any AGOR course, with the exception of AGOR 1, must be taken prior to or concurrent with AGOR 91. Compliance with work experience regulations as designated in the College Catalog.*

On-the-job experience at an approved work site. Minimum of 75 paid or 60 non-paid clock hours per credit unit.

10495 arrange 12.5 hours Hinostroza, J 80-2301J

**NOTE: CRN 10495 above** requires student to attend orientation on June 19, 2018 from 1 pm to 2:30 pm in building 80-1431 to obtain required paperwork for the course. Students that fail to attend orientation may be in jeopardy of losing their seat in the class. Work Experience packets will be issued and students will be confirmed for the course at that time. Students must complete 1/3 of the program units in the major before registering for work experience or concurrently enrolled in a SAM-C course. A minimum of 60 unpaid/75 paid hours of work required per credit. For questions regarding orientation, please contact Arnita Champion at 909-274-6080 or via email at achampion@mtsac.edu

### AIR CONDITIONING AND REFRIGERATION

■ **AIRC 12 — Air Conditioning Codes and Standards** **3.0 Units**  
Degree Applicable

Skills necessary to read and interpret building codes and standards as they apply to air conditioning and refrigeration.

10567 TWTh 9:30am - 12:20pm Kobzoff, F 69-6924

**NOTE: AIRC 12, CRN 10567 is linked to AIRC 32A, CRN 10568. You must enter both CRNs on the registration screen at the same time. Contact the department chair Lanny Richardson at lrichardson@mtsac.edu for further information.**

■ **AIRC 26 — Gas Heating Fundamentals** **2.0 Units**  
Degree Applicable

*Advisory: AIRC 12 and AIRC 25*

Theory, operation, and application of natural gas and propane heating systems in residential and light commercial installations.

10043 TW 7:00pm - 9:50pm Lane, J 69-6924

■ **AIRC 32A — Air Properties and Measurement** **1.5 Units**  
Degree Applicable

*Advisory: AIRC 20 and AIRC 30 taken prior*

Investigates the air-side operating theory and application of comfort cooling systems by addressing psychrometric principles.

10568 TW 1:30pm - 3:35pm Richardson, L 69-6912

**NOTE: AIRC 32A, CRN 10568 is linked to AIRC 12, CRN 10567. You must enter both CRNs on the registration screen at the same time. Contact the department chair Lanny Richardson at lrichardson@mtsac.edu for further information.**



## Air Conditioning & Refrigeration Technology

Get hands-on training with actual refrigeration components and systems — all using the latest technology.

**Codes & Standards • Heat Loads  
Pneumatics Gas Heating • Psychometrics  
Refrigeration • Duct Design  
Building Automation**

For more information, please call:

**909-274-5107**

## AIRCRAFT MAINTENANCE TECHNOLOGY

■ **AIRM 71 — Aviation Maintenance Science** **6.0 Units**  
Degree Applicable  
Federal regulations and forms, technical math, aircraft weight and balance computations, and aircraft drawings.  
**10535 MTWTh 5:30pm - 10:00pm STAFF 28B-108**

■ **AIRM 74 — Aircraft Maintenance Technology - Work Experience** **2.0 Units**  
Degree Applicable

(May be taken for Pass/No Pass Only)

*Prerequisite: AIRM 65A and AIRM 65B or AIRM 66A and AIRM 66B*

Two units of college credit earned for 120 unpaid or 150 paid work hours under direct supervision at an aircraft maintenance facility.

**10039 arrange 23.33 hours Yost, D 28A-102**

## ALCOHOL DRUG COUNSELING

■ **AD 1 — Alcohol and Drug Dependency** **3.0 Units**  
Degree Applicable, CSU

Overview of alcohol/drug use and abuse. Effects on individuals, families, and society. Various approaches to recovery.

**10979 MWTh 7:30am - 10:20am Likens, J 67A-216**

■ **AD 3 — Chemical Dependency: Intervention, Treatment and Recovery** **3.0 Units**  
Degree Applicable, CSU

Examines techniques used in chemical dependency treatment. Analyzes types of treatment programs and the essentials of recovery.

**10040 MWTh 4:30pm - 7:20pm Staley, G 67A-205**

■ **AD 4 — Issues in Domestic Violence** **3.0 Units**  
Degree Applicable

History, law, and psychology of domestic violence. Cultural, social aspects, and relationship to substance abuse explored.

**10049 MWTh 7:30pm - 10:20pm Day, C 67A-205**

## AMERICAN LANGUAGE

■ **AMLA 33R — American Language Advanced Reading** **4.0 Units**  
Degree Applicable

(May be taken for option of Letter grade or Pass/NoPass)

*Advisory: Eligibility for AMLA 43W*

Advanced reading and vocabulary for non-native speakers.

**10664 MTWTh 10:30am - 1:20pm Casian, E 66-246**

■ **AMLA 42W — American Language Intermediate Writing** **4.0 Units**  
Not Degree Applicable

(May be taken for option of Letter grade or Pass/NoPass)

*Prerequisite: Satisfactory score on the English Placement Test or successful completion of AMLA 41W or noncredit ESL Level 5 or 6 or VESL*

*Advisory: AMLA 32R taken prior or concurrently*

Intermediate grammar and writing for non-native speakers.

**10065 MTWTh 7:30am - 10:20am Stokes, N 26A-2610**

■ **AMLA 43W — American Language Advanced Writing** **4.0 Units**  
Not Degree Applicable

(May be taken for option of Letter grade or Pass/NoPass)

*Prerequisite: Satisfactory score on the English Placement Test or successful completion of AMLA 42W*

*Advisory: AMLA 33R taken prior or concurrently*

Advanced grammar and writing for non-native speakers.

**10068 MTWTh 10:30am - 1:20pm Stokes, N 26A-2610**  
**10145 MTWTh 4:30pm - 7:20pm STAFF 66-222**



## AIRCRAFT MAINTENANCE

• FAA-Certified Aircraft Maintenance Technician School

• Be Working in as soon as 2 years

• Day and evening classes

• Earn an A.S. degree or certificate

For information or shop tours, call  
**909-274-4762**

## ANATOMY AND PHYSIOLOGY

■ **ANAT 10A — Introductory Human Anatomy** **4.0 Units**  
Degree Applicable, CSU, UC

*Advisory: BIOL 1*

Macroscopic and microscopic structure of the human body.

10497	MTWTh	8:00am - 10:05am	Meyer, E	60-2503
and	MTWTh	10:25am - 12:30pm	Meyer, E	11-2406
10499	MTWTh	8:00am - 10:05am	Aasi, F	11-2406
and	MTWTh	10:25am - 12:30pm	Aasi, F	60-2503
10498	MTWTh	10:25am - 12:30pm	Meyer, E	11-2406
and	MTWTh	12:50pm - 2:55pm	Meyer, E	60-2503
11053	MTWTh	12:50pm - 2:55pm	Fernandez Lango, B	61-2320
and	MTWTh	3:15pm - 5:25pm	Fernandez Lango, B	60-2503

■ **ANAT 10B — Introductory Human Physiology** **4.0 Units**  
Degree Applicable, CSU, UC

*Prerequisite: ANAT 10A or ANAT 35*

*Advisory: (CHEM 10 or CHEM 40) and BIOL 1*

Integrated study of the functions of and interactions between human organ systems.

10500	MTWTh	8:00am - 10:05am	Borup, R	60-2515
and	MTWTh	10:15am - 12:20pm	Borup, R	61-2320
10528	MTWTh	10:25am - 12:30pm	Fernandez Lango, B	60-2515
and	MTWTh	12:50pm - 2:55pm	Shea, N	7-1120

■ **ANAT 35 — Human Anatomy** **5.0 Units**  
Degree Applicable, CSU, UC

*Prerequisite: BIOL 1 or BIOL 4 or BIOL 4H*

Structure of organ systems at the gross, subgross, and microscopic levels based on human material and dissection of the cat.

10501	MTWTh	10:15am - 12:20pm	Pascoe, V	7-1120
and	MTWTh	1:00pm - 5:15pm	Pascoe, V	60-2511

■ **ANAT 36 — Human Physiology** **5.0 Units**

Degree Applicable, CSU, UC

*Prerequisite: BIOL 1 or BIOL 4 or BIOL 4H and ANAT 35 and CHEM 10 or CHEM 40*

Human physiology at the cellular and molecular levels of all organ systems, including regulation and integration.

10502 MTWTh 10:05am - 12:10pm Manookian, D 11-2402  
and MTWTh 12:50pm - 5:05pm Manookian, D 60-2515

**ANTHROPOLOGY**

■ **ANTH 1 — Biological Anthropology** **3.0 Units**

Degree Applicable, CSU, UC

*Prerequisite: Eligibility for ENGL 68*

Evolutionary biology of primates, including and focusing on humans.

10503 TWTh 7:30am - 10:20am Borella, F 61-2312  
10504 TWTh 10:30am - 1:20pm Borella, F 61-2312

■ **ANTH 1L — Biological Anthropology Laboratory** **1.0 Unit**

Degree Applicable, CSU, UC

*Corequisite: ANTH 1 or ANTH 1H (May have been taken previously)*

Scientific study of human evolution. Hands-on experience with the subject matter of ANTH 1.

10505 TWTh 1:30pm - 4:20pm Borella, F 60-2620

■ **ANTH 5 — Cultural Anthropology** **3.0 Units**

Degree Applicable, CSU, UC

*Prerequisite: Eligibility for ENGL 68*

The anthropological approach to the study of culture and human behavior from a cross-cultural and comparative perspective.

10772 T 10:30am - 12:35pm Norvell, J 60-2620  
and arrange 6.7 hours Norvell, J ONLINE

■ **ANTH 22 — General Cultural Anthropology** **3.0 Units**

Degree Applicable, CSU, UC

Culture and how cultural anthropologists study cultural phenomena. May meet cultural diversity requirement at transfer universities.

10826 MTWTh 8:00am - 10:05am Nightwine-Robinson, D 60-2620  
10771 T 7:15pm - 9:20pm Norvell, J 61-2312  
and arrange 6.7 hours Norvell, J ONLINE

**NOTE: CRN 10771 is a Hybrid Class** taught partially online with Scheduled Meetings on Campus.

**Course Orientation:** Course orientation schedule above is mandatory. If student cannot attend orientation, student must contact professor before orientation meeting to avoid being dropped from class.

**How to Begin Course:** Log into Canvas through the e-Learning Tools tab in the Mt.SAC portal at [inside.mtsac.edu](http://inside.mtsac.edu). Then click on the Canvas link and then click on the CRN to log into your DL course. **NOTE:** Some courses may not be activated until the start of the term. If you cannot locate your DL course in Canvas when the term starts, contact the professor. **On the first day of classes, log into your DL course to show your "attendance" because not doing so could result in your being dropped from the class for non-attendance.**

**Professor contact info:** Email Professor John Norvell at either: [jnorvell@mtsac.edu](mailto:jnorvell@mtsac.edu), through Student Detail Schedule or Canvas at MyMt-SAC Portal.

**Students must use their Mt.SAC e-mail account and be aware of course commitment and student expectations described at <http://www.mtsac.edu/distancelearning/>**

**To prepare for a successful online learning experience, see helpful short videos at <http://www.mtsac.edu/distancelearning/quiz/>**

**ARABIC**

■ **ARAB 1 — Elementary Arabic** **4.0 Units**

Degree Applicable, CSU, UC

For students without previous exposure to Modern Arabic. Focuses on script, pronunciation, basic grammar and vocabulary.

10563 MTWTh 10:30am - 1:20pm Hammad Hammad, M 21J-1

**ARCHITECTURAL TECHNOLOGY**

■ **ARCH 141 — Design Drawing and Communication** **4.0 Units**

Degree Applicable, CSU, UC

Architectural drawing techniques. Field trips required.

11392 MTWTh 6:30pm - 7:30pm STAFF 13-2215  
and MTWTh 7:40pm - 10:45pm STAFF 13-2215

■ **ARCH 250 — World Architecture I** **3.0 Units**

Degree Applicable, CSU, UC

Development of world architecture from pre-history to the Middle Ages.

Field trips required.

10776 MW 5:10pm - 9:25pm Fields, G 28B-106

■ **ARCH 251 — World Architecture II** **3.0 Units**

Degree Applicable, CSU, UC

Development of world architecture from the Renaissance to the present.

Field trips required.

10777 MW 12:20pm - 4:35pm Fields, G 28B-106

**ART: ANIMATION**

■ **ANIM 100 — Digital Paint and Ink** **3.0 Units**

Degree Applicable

Illustration skills used in digital animation and game production.

10982 MTWTh 8:00am - 9:15am Rivas, H 13-2450  
and MTWTh 9:25am - 12:15pm Rivas, H 13-2450

**Put your career in motion!**

**Animation**  
**Degree and Certificate Options**

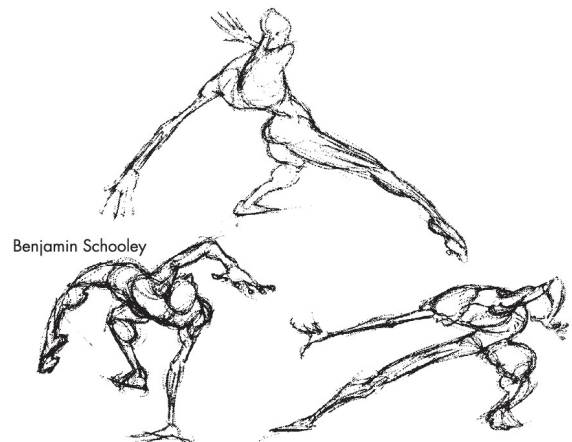

Benjamin Schooley

for more information, contact Debbie Bautista  
**909-274-4565**

**ANIM 131 — Introduction to Gaming** **3.0 Units**

Degree Applicable, CSU, UC

(May be taken for option of Letter grade or Pass/NoPass)

The field of game design including the principles, tools, and strategies for designing various types of games.

10986 MTWTh 8:00am - 9:15am Dunipace, T 13-2435  
and MTWTh 9:25am - 12:15pm Dunipace, T 13-2435**ART: BASIC STUDIO ARTS****ARTB 1 — Introduction to the Visual Arts and Art History** **3.0 Units**

Degree Applicable, CSU, UC

*Prerequisite: Eligibility for ENGL 68*

Visual arts, art history, and role of art in context; field trips possible.

Credit not given for ARTB 1 and AHIS 1.

10641 TWTh 10:00am - 1:05pm Alexander, C 1B/C-12

**ART: GRAPHIC DESIGN AND ILLUSTRATION****ARTC 100 — Fundamentals of Graphic Design** **3.0 Units**

Degree Applicable, CSU

*Advisory: ARTD 15A and ARTD 20*

Fundamentals of graphic design for the commercial art industry. Software: Adobe Photoshop.

10569 MTWTh 9:00am - 10:15am Hartmann, C 13-2440  
and MTWTh 10:25am - 1:15pm Hartmann, C 13-2440**ART: THREE-DIMENSIONAL STUDIO ARTS****ARTS 30A — Ceramics: Beginning I** **3.0 Units**

Degree Applicable, CSU, UC

Clay, glazes, and firing through projects and analysis, using hand building and the wheel. Field trip required.

10646 MTWTh 9:00am - 10:15am Keena, S 1A-10  
and MTWTh 10:25am - 1:15pm Keena, S 1A-10**NOTE:** CRN 10646: No-cost digital textbooks or textual materials used10643 MTWTh 1:20pm - 2:35pm Reynoso, H 1A-10  
and MTWTh 2:45pm - 5:35pm Reynoso, H 1A-10**NOTE:** CRN 10643: No-cost digital textbooks or textual materials used**ARTS 40A — Sculpture: Beginning** **3.0 Units**

Degree Applicable, CSU, UC

Traditional and contemporary approaches to sculpture.

10647 MTWTh 9:00am - 10:15am Deines, C 1A-7  
and MTWTh 10:25am - 1:15pm Deines, C 1A-7**NOTE:** CRN 10647: No-cost digital textbooks or textual materials used**ARTS 40B — Sculpture: Intermediate** **3.0 Units**

Degree Applicable, CSU, UC

*Prerequisite: ARTS 40A*

Sculpture projects in subtractive, additive, and manipulative approaches.

10648 MTWTh 9:00am - 10:15am Deines, C 1A-7  
and MTWTh 10:25am - 1:15pm Deines, C 1A-7**NOTE:** CRN 10648: No-cost digital textbooks or textual materials used**ARTS 40C — Sculpture: Carving** **3.0 Units**

Degree Applicable, CSU, UC

*Prerequisite: ARTS 40A*

Advanced projects in stone or wood carving using hand, power and pneumatic tools. Emphasis is on individual interpretation

10649 MTWTh 9:00am - 10:15am Deines, C 1A-7  
and MTWTh 10:25am - 1:15pm Deines, C 1A-7**NOTE:** CRN 10649: No-cost digital textbooks or textual materials used**ART: TWO-DIMENSIONAL STUDIO ARTS****ARTD 15A — Drawing: Beginning** **3.0 Units**

(C-ID ARTS 110) Degree Applicable, CSU, UC

An entry level course emphasizing creative expression through the use of drawing media.

10651 MTWTh 8:00am - 9:15am Butler, T 1B/C-4  
and MTWTh 9:25am - 12:15pm Butler, T 1B/C-4**NOTE:** CRN 10651: No-cost digital textbooks or textual materials used10652 MTWTh 9:00am - 10:15am Brown, D 1B/C-5  
and MTWTh 10:25am - 1:15pm Brown, D 1B/C-5**NOTE:** CRN 10652: No-cost digital textbooks or textual materials used10650 MTWTh 1:20pm - 2:35pm Alexander, C 1A-4  
and MTWTh 2:45pm - 5:35pm Alexander, C 1A-4**NOTE:** CRN 10650: No-cost digital textbooks or textual materials used**10653 MTWTh 5:45pm - 7:00pm Impert, W 1B/C-5**  
**and MTWTh 7:10pm - 10:00pm Impert, W 1B/C-5****NOTE:** CRN 10653: No-cost digital textbooks or textual materials used**ARTD 17A — Drawing: Life** **3.0 Units**

(C-ID ARTS 200) Degree Applicable, CSU, UC

*Prerequisite: ARTD 15A or ANIM 104*

Contemporary and traditional approaches to drawing the human figure.

10654 MTWTh 8:30am - 9:45am Stubbs, T 1A-4  
and MTWTh 9:55am - 12:45pm Stubbs, T 1A-4**ARTD 17B — Drawing: Life-Intermediate** **3.0 Units**

Degree Applicable, CSU, UC

*Prerequisite: ARTD 17A*

Contemporary and traditional approaches to sketching and drawing the human figure.

10655 MTWTh 8:30am - 9:45am Stubbs, T 1A-4  
and MTWTh 9:55am - 12:45pm Stubbs, T 1A-4**NOTE:** CRN 10655: No-cost digital textbooks or textual materials used**ARTD 25A — Beginning Painting I** **3.0 Units**

(C-ID ARTS 210) Degree Applicable, CSU, UC

Development of basic paint applications focusing on the formal elements of composition, light logic, and color.

10657 MTWTh 1:20pm - 2:35pm Clapp, D 1B/C-6  
and MTWTh 2:45pm - 5:35pm Clapp, D 1B/C-6**NOTE:** CRN 10657: No-cost digital textbooks or textual materials used**ARTD 25B — Beginning Painting II** **3.0 Units**

Degree Applicable, CSU, UC

*Prerequisite: ARTD 25A*

Creation of large paintings through various styles including mixed media.

10658 MTWTh 1:20pm - 2:35pm Clapp, D 1B/C-6  
and MTWTh 2:45pm - 5:35pm Clapp, D 1B/C-6**NOTE:** CRN 10658: No-cost digital textbooks or textual materials used**ARTD 26A — Intermediate Painting I** **3.0 Units**

Degree Applicable, CSU, UC

*Prerequisite: ARTD 25B*

Creation of large works focusing on conceptual issues and art historical influences.

10659 MTWTh 1:20pm - 2:35pm Clapp, D 1B/C-6  
and MTWTh 2:45pm - 5:35pm Clapp, D 1B/C-6**NOTE:** CRN 10659: No-cost digital textbooks or textual materials used**ARTD 26B — Intermediate Painting II** **3.0 Units**

Degree Applicable, CSU, UC

*Prerequisite: ARTD 26A*

Development of a personal style focusing on conceptual issues and art historical influences.

10660 MTWTh 1:20pm - 2:35pm Clapp, D 1B/C-6  
and MTWTh 2:45pm - 5:35pm Clapp, D 1B/C-6**NOTE:** CRN 10660: No-cost digital textbooks or textual materials used

## ART HISTORY

**AHIS 1 — Introduction to the Visual Arts and Art History 3.0 Units**  
 Degree Applicable, CSU, UC

*Prerequisite: Eligibility for ENGL 68*

Visual arts, art history, and role of art in context; field trips possible.  
 Credit not given for both ARTB 1 and AHIS 1.

10597	TWTh	7:30am - 10:20am	Staylor, D	26D-2411
-------	------	------------------	------------	----------

**NOTE: No cost digital textbooks or textual materials used.**

10598	TWTh	10:30am - 1:20pm	Martin, D	26D-2411
-------	------	------------------	-----------	----------

10599	TWTh	1:30pm - 4:20pm	Salomone, T	26D-2411
-------	------	-----------------	-------------	----------

10600	TWTh	4:30pm - 7:20pm	McGuire, M	26D-2220
-------	------	-----------------	------------	----------

**AHIS 4 — History of Western Art: Prehistoric Through Gothic 3.0 Units**

(C-ID ARTH 110) Degree Applicable, CSU, UC

*Prerequisite: Eligibility for ENGL 68*

Western art from Prehistoric through Gothic periods; relationship of visual art forms to each other and to the cultural context.

10601	TWTh	10:30am - 1:20pm	Hight, D	26D-2220
-------	------	------------------	----------	----------

**AHIS 5 — History of Western Art: Renaissance Through Modern 3.0 Units**

(C-ID ARTH 120) Degree Applicable, CSU, UC

*Prerequisite: Eligibility for ENGL 68*

History of Renaissance through Modern art in cultural context. Off-campus assignments may be required.

10602	TWTh	1:30pm - 4:20pm	McGuire, M	26D-2220
-------	------	-----------------	------------	----------

**AHIS 6 — History of Modern Art 3.0 Units**  
 Degree Applicable, CSU, UC

*Prerequisite: Eligibility for ENGL 68*

Artistic movements, influences, and individuals forming the Modern tradition. Off campus trips may be required.

10603	TWTh	4:30pm - 7:20pm	Salomone, T	26D-2411
-------	------	-----------------	-------------	----------

**AHIS 10 — A History of Greek and Roman Art and Architecture 3.0 Units**

Degree Applicable, CSU, UC

*Prerequisite: Eligibility for ENGL 1A*

History of Greek and Roman art and architecture before 500 CE in cultural context and influences on Europe and America.

10604	TWTh	7:30am - 10:20am	Hight, D	26D-2220
-------	------	------------------	----------	----------

## ASTRONOMY

**ASTR 5 — Introduction to Astronomy 3.0 Units**  
 Degree Applicable, CSU, UC

*Prerequisite: Eligibility for ENGL 1A*

Introductory survey of the Universe. Enroll in ASTR 5L to receive laboratory science credit. Field trips may be required.

10450	MTW	7:30am - 10:20am	STAFF	11-2119
-------	-----	------------------	-------	---------

10451	MTW	10:30am - 1:20pm	STAFF	11-2119
-------	-----	------------------	-------	---------

**ASTR 8 — Introduction to Stars, Galaxies, and the Universe 3.0 Units**

Degree Applicable, CSU, UC

Structure and evolution of stars, galaxies, and universe. Enroll in ASTR 5L to receive lab science credit. Field trips required.

10452	arrange	9 hours	Bray-Ali, F	ONLINE
-------	---------	---------	-------------	--------

**NOTE:** CRN 10452 is a fully online class with no on-campus meetings.

How to Begin Course: Log into Canvas through the eLearning Tools tab in the Mt. SAC portal at <https://inside.mtsac.edu/> Then click on the Canvas link, and then click on CRN for your online course. **NOTE:** Some courses may not be activated until the start of the term. If you cannot locate your online course in Canvas when the term starts, contact the professor. On the first day of classes, log into your online course to complete the required task(s) set by your professor to show your "attendance" because not doing so could result in your being dropped from the class for non-attendance. Professor contact info: Email Professor Julie Bray-Ali at [jbray-ali@mtsac.edu](mailto:jbray-ali@mtsac.edu) Students must use their Mt. SAC e-mail account and be aware of course commitment and student expectations described at <http://www.mtsac.edu/distancelearning/> **To prepare for a successful online learning experience, see helpful short videos <http://www.mtsac.edu/distancelearning/quiz/>**

## BIOLOGY

**BIOL 1 — General Biology 4.0 Units**  
 Degree Applicable, CSU, UC

*Prerequisite: Eligibility for ENGL 68*

*Advisory: READ 90*

Major principles and concepts of biology for the non-science major.

10507	TWTh	7:30am - 10:20am	Saad, N	11-2312
-------	------	------------------	---------	---------

and	TWTh	10:30am - 1:20pm	Saad, N	7-1111
-----	------	------------------	---------	--------

10510	TWTh	7:30am - 10:20am	STAFF	11-2105
-------	------	------------------	-------	---------

and	TWTh	10:30am - 1:20pm	STAFF	7-1108
-----	------	------------------	-------	--------

10508	TWTh	10:30am - 1:20pm	Ito Rocha Santana, N	7-1209
-------	------	------------------	----------------------	--------

and	TWTh	2:00pm - 4:50pm	Ito Rocha Santana, N	7-1111
-----	------	-----------------	----------------------	--------

10515	TWTh	10:30am - 1:20pm	Churchill, D	7-1205
-------	------	------------------	--------------	--------

and	TWTh	2:00pm - 4:50pm	Churchill, D	7-1108
-----	------	-----------------	--------------	--------

10554	TWTh	10:30am - 1:20pm	STAFF	7-1115
-------	------	------------------	-------	--------

and	TWTh	2:00pm - 4:50pm	STAFF	11-2406
-----	------	-----------------	-------	---------

10509	TWTh	3:30pm - 6:20pm	Hewson, W	61-2320
-------	------	-----------------	-----------	---------

and	TWTh	7:00pm - 9:50pm	Hewson, W	7-1111
-----	------	-----------------	-----------	--------

10516	TWTh	3:30pm - 6:20pm	Marino, T	7-1120
-------	------	-----------------	-----------	--------

and	TWTh	7:00pm - 9:50pm	Marino, T	7-1108
-----	------	-----------------	-----------	--------

10517	TWTh	3:30pm - 6:20pm	STAFF	11-2312
-------	------	-----------------	-------	---------

and	TWTh	7:00pm - 9:50pm	STAFF	7-1115
-----	------	-----------------	-------	--------

**BIOL 4 — Biology for Majors 4.0 Units**  
 Degree Applicable, CSU, UC

*Prerequisite: (CHEM 10 or CHEM 40) and MATH 71*

*Advisory: Eligibility for ENGL 1A*

General biology for science majors. Principles of biology required for advanced study. Field trips with extensive hiking required.

10511	MTWTh	10:00am - 12:50pm	Anderson-McGill, T	60-2628
-------	-------	-------------------	--------------------	---------

and	MTWTh	1:00pm - 3:05pm	Anderson-McGill, T	11-2312
-----	-------	-----------------	--------------------	---------

10518	MTWTh	12:30pm - 2:35pm	Mc Cabe, D	11-2402
-------	-------	------------------	------------	---------

and	MTWTh	2:40pm - 5:30pm	Mc Cabe, D	60-2628
-----	-------	-----------------	------------	---------

**BIOL 5 — Contemporary Health Issues****3.0 Units**

Degree Applicable, CSU, UC

Contemporary health issues known to affect the quality and longevity of life with emphasis on prevention of illness and injuries.

10555 arrange 9 hours Hoggan, L ONLINE

**NOTE: CRN 10555 is a Distance Learning Online Class.**

**How to Begin Course:** Log into Canvas through the e-Learning Tools tab in the Mt.SAC portal at [inside.mtsac.edu](http://inside.mtsac.edu). Then click on the Canvas link and then click on the CRN to log into your DL course. **NOTE:** Some courses may not be activated until the start of the term. If you cannot locate your DL course in Canvas when the term starts, contact the professor. **On the first day of classes, log into your DL course to show your "attendance" because not doing so could result in your being dropped from the class for non-attendance.**

**Professor contact info:** Email Professor Lynda Hoggan at either: [lhoggan@mtsac.edu](mailto:lhoggan@mtsac.edu), through Student Detail Schedule or Canvas at MyMtSAC Portal.

**Students must use their Mt.SAC e-mail account and be aware of course commitment and student expectations described at <http://www.mtsac.edu/distancelearning/>**

**To prepare for a successful online learning experience, see helpful short videos at <http://www.mtsac.edu/distancelearning/quiz/>**

**BIOL 15H — Human Sexuality - Honors****3.0 Units**

Degree Applicable, CSU, UC

*Prerequisite: Acceptance into the Honors Program*

An honors version of BIOL 15. Contains mature and sexually explicit content. May not receive credit for both BIOL 15 and BIOL 15H.

10524 arrange 9 hours Hoggan, L ONLINE

**NOTE: CRN 10524 is a Distance Learning Online Class.**

**How to Begin Course:** Log into Canvas through the e-Learning Tools tab in the Mt.SAC portal at [inside.mtsac.edu](http://inside.mtsac.edu). Then click on the Canvas link and then click on the CRN to log into your DL course. **NOTE:** Some courses may not be activated until the start of the term. If you cannot locate your DL course in Canvas when the term starts, contact the professor. **On the first day of classes, log into your DL course to show your "attendance" because not doing so could result in your being dropped from the class for non-attendance.**

**Professor contact info:** Email Professor Lynda Hoggan at either: [lhoggan@mtsac.edu](mailto:lhoggan@mtsac.edu), through Student Detail Schedule or Canvas at MyMtSAC Portal.

**Students must use their Mt.SAC e-mail account and be aware of course commitment and student expectations described at <http://www.mtsac.edu/distancelearning/>**

**To prepare for a successful online learning experience, see helpful short videos at <http://www.mtsac.edu/distancelearning/quiz/>**

**BIOL 20 — Marine Biology****3.0 Units**

Degree Applicable, CSU, UC

The marine environment including the principles of marine science. Field trip required.

10519 MTWTh 8:00am - 10:05am Whitlow, L 7-1205  
10773 TWTh 7:30pm - 10:20pm Gan, N 7-1205

**BUSINESS: ACCOUNTING****BUSA 7 — Principles of Accounting - Financial****5.0 Units**

(C-ID ACCT 110) Degree Applicable, CSU, UC

*Prerequisite: BUSA 11 or eligibility for MATH 51*

*Advisory: Eligibility for ENGL 1A*

Financial accounting required of Business Administration and Accounting majors.

10338 TWTh 10:00am - 2:50pm Valdes, S 79-3250  
10322 MW 12:30pm - 5:20pm Hoekstra, T 79-3230  
and arrange 5.8 hours Hoekstra, T

**NOTE: CRN 10322 is a Hybrid Class** taught partially online with Scheduled Meetings on Campus.

**How to Begin Course:** Log into Canvas through the e-Learning Tools tab in the Mt.SAC portal at [inside.mtsac.edu](http://inside.mtsac.edu). Then click on the Canvas link and then click on the CRN to log into your DL course. **NOTE:** Some courses may not be activated until the start of the term. If you cannot locate your DL course in Canvas when the term starts, contact the professor. **On the first day of classes, log into your DL course to show your "attendance" because not doing so could result in your being dropped from the class for non-attendance.**

**Professor contact info:** Email Professor Hoekstra at either: [Thoekstra@mtsac.edu](mailto:Thoekstra@mtsac.edu), through Student Detail Schedule or Canvas at MyMtSAC Portal.

**Students must use their Mt.SAC e-mail account and be aware of course commitment and student expectations described at <http://www.mtsac.edu/distancelearning/>**

**To prepare for a successful online learning experience, see helpful short videos at <http://www.mtsac.edu/distancelearning/quiz/>**

10279 MW 5:30pm - 10:20pm Ildefonso, N 79-3230  
and arrange 5.8 hours Ildefonso, N ONLINE

**NOTE: CRN 10279 is a Hybrid Class** taught partially online with Scheduled Meetings on Campus.

**How to Begin Course:** Log into Canvas through the e-Learning Tools tab in the Mt.SAC portal at [inside.mtsac.edu](http://inside.mtsac.edu). Then click on the Canvas link and then click on the CRN to log into your DL course. **NOTE:** Some courses may not be activated until the start of the term. If you cannot locate your DL course in Canvas when the term starts, contact the professor. **On the first day of classes, log into your DL course to show your "attendance" because not doing so could result in your being dropped from the class for non-attendance.**

**Professor contact info:** Email Professor Ildefonso at either: [NIldefonso@mtsac.edu](mailto:NIldefonso@mtsac.edu), through Student Detail Schedule or Canvas at MyMtSAC Portal.

**Students must use their Mt.SAC e-mail account and be aware of course commitment and student expectations described at <http://www.mtsac.edu/distancelearning/>**

**To prepare for a successful online learning experience, see helpful short videos at <http://www.mtsac.edu/distancelearning/quiz/>**

**BUSA 8 — Principles of Accounting - Managerial****5.0 Units**

(C-ID ACCT 120) Degree Applicable, CSU, UC

*Prerequisite: BUSA 7*

Managerial accounting concepts and principles. Provides the accounting tools and methods needed for decision making in business.

10355 MTW 10:00am - 2:50pm Bates, B 79-3260  
10306 MTW 5:30pm - 10:20pm Bates, B 79-3250

**■ BUSA 11 — Fundamentals of Accounting** **3.0 Units**

Degree Applicable

*Prerequisite: BUSA 68 or eligibility for MATH 50*

Accounting vocabulary and theory, equations to solve word problems and other calculations used in accounting problems.

10280 arrange 9 hours Mc Geough, D ONLINE

**NOTE: CRN 10280 is a Distance Learning Online Class.**

**How to Begin Course:** Log into Canvas through the e-Learning Tools tab in the Mt.SAC portal at [inside.mtsac.edu](http://inside.mtsac.edu). Then click on the Canvas link and then click on the CRN to log into your DL course. **NOTE:** Some courses may not be activated until the start of the term. If you cannot locate your DL course in Canvas when the term starts, contact the professor. **On the first day of classes, log into your DL course to show your "attendance" because not doing so could result in your being dropped from the class for non-attendance.**

**Professor contact info:** Email Professor McGeough at either: DMc-Geough@mtsac.edu, through Student Detail Schedule or Canvas at MyMtSAC Portal.

**Students must use their Mt.SAC e-mail account and be aware of course commitment and student expectations described at <http://www.mtsac.edu/distancelearning/>**

**To prepare for a successful online learning experience, see helpful short videos at <http://www.mtsac.edu/distancelearning/quiz/>**

**■ BUSA 68 — Business Mathematics** **3.0 Units**

Not Degree Applicable

Addition, subtraction, multiplication, division, decimals, percentages, fractions, equations, and problem solving.

10281 arrange 9 hours Mc Geough, D ONLINE

**NOTE: CRN 10281 is a Distance Learning Online Class.**

**How to Begin Course:** Log into Canvas through the e-Learning Tools tab in the Mt.SAC portal at [inside.mtsac.edu](http://inside.mtsac.edu). Then click on the Canvas link and then click on the CRN to log into your DL course. **NOTE:** Some courses may not be activated until the start of the term. If you cannot locate your DL course in Canvas when the term starts, contact the professor. **On the first day of classes, log into your DL course to show your "attendance" because not doing so could result in your being dropped from the class for non-attendance.**

**Professor contact info:** Email Professor McGeough at either: DMc-Geough@mtsac.edu, through Student Detail Schedule or Canvas at MyMtSAC Portal.

**Students must use their Mt.SAC e-mail account and be aware of course commitment and student expectations described at <http://www.mtsac.edu/distancelearning/>**

**To prepare for a successful online learning experience, see helpful short videos at <http://www.mtsac.edu/distancelearning/quiz/>**

**■ BUSA 70 — Payroll and Tax Accounting** **3.0 Units**

Degree Applicable

*Prerequisite: Eligibility for BUSA 11*

On-the-job payroll accounting.

10311 MW 5:10pm - 9:40pm Quintero, H 79-3270

**■ BUSA 75 — Using Microcomputers in Financial Accounting** **1.0 Unit**

Degree Applicable

*Prerequisite: BUSA 7 or BUSA 72*

Accounting concepts utilizing QuickBooks, a general-ledger software program. Computer processing of accounting transactions.

10329 M 7:30pm - 10:20pm Bowers, E 77-2040

**■ BUSA 76 — Using Microcomputers in Managerial Accounting** **1.0 Unit**

Degree Applicable

*Prerequisite: BUSA 7 or BUSA 72*

Analysis of financial data and preparation of managerial accounting reports using Excel software.

10330 W 7:15pm - 10:20pm Bowers, E 77-2040

**BUSINESS: BUSINESS COMMUNICATIONS****■ BUSO 25 — Business Communications** **3.0 Units**

(C-ID BUS 115)

Degree Applicable, CSU

*Prerequisite: ENGL 1A*

Apply writing principles to produce effective good news, bad news, sales, claims, persuasive, and job seeking correspondence.

10316 TTh 7:30am - 11:45am Bartz, V 79-3290

**BUSINESS: ECONOMICS****■ BUSC 1A — Principles of Economics - Macroeconomics** **3.0 Units**

(C-ID ECON 202)

Degree Applicable, CSU, UC

*Prerequisite: Eligibility for ENGL 1A, and successful completion of MATH 71, or MATH 71B, or MATH 71X*

Principles of aggregate economic analysis.

10290 MTW 7:30am - 10:20am Dua, A 78-3160

10307 MTW 10:30am - 1:20pm Dua, A 78-3160

10341 MW 5:10pm - 9:40pm Zawahri, L 78-3160

**■ BUSC 1B — Principles of Economics - Microeconomics** **3.0 Units**

(C-ID ECON 201)

Degree Applicable, CSU, UC

*Prerequisite: BUSC 1A or BUSC 1AH*

10292 MTW 10:30am - 1:20pm Chan, F 77-2070

10291 MTW 1:30pm - 4:20pm Dua, A 78-3160

**BUSINESS: LAW****■ BUSL 18 — Business Law** **3.0 Units**

(C-ID BUS 125)

Degree Applicable, CSU, UC

*Prerequisite: Eligibility for ENGL 68*

Business law: court procedures, ethics, torts, crimes, contract law, and sales of goods under the Uniform Commercial Code.

10283 TWTh 10:30am - 1:20pm Bladh, E 78-3120

10333 MW 5:10pm - 9:25pm Bladh, E 78-3120

10337 arrange 9 hours Mc Kee, C ONLINE

**NOTE: CRN 10337 is a Distance Learning Online Class.**

**How to Begin Course:** Log into Canvas through the e-Learning Tools tab in the Mt.SAC portal at [inside.mtsac.edu](http://inside.mtsac.edu). Then click on the Canvas link and then click on the CRN to log into your DL course. **NOTE:** Some courses may not be activated until the start of the term. If you cannot locate your DL course in Canvas when the term starts, contact the professor. **On the first day of classes, log into your DL course to show your "attendance" because not doing so could result in your being dropped from the class for non-attendance.**

**Professor contact info:** Email Professor McKee at either: CMcKee@mtsac.edu, through Student Detail Schedule or Canvas at MyMtSAC Portal.

**Students must use their Mt.SAC e-mail account and be aware of course commitment and student expectations described at <http://www.mtsac.edu/distancelearning/>**

**To prepare for a successful online learning experience, see helpful short videos at <http://www.mtsac.edu/distancelearning/quiz/>**



■ **BUSL 19 — Advanced Business Law** **3.0 Units**  
Degree Applicable, CSU, UC

*Advisory: BUSL 18*

Principles of business law emphasizing commercial paper, agency, business entities, bankruptcy, trade, and real property.

10326 arrange 9 hours Wood, A ONLINE

**NOTE: CRN 10326 is a Distance Learning Online Class.**

**How to Begin Course:** Log into Canvas through the e-Learning Tools tab in the Mt.SAC portal at [inside.mtsac.edu](http://inside.mtsac.edu). Then click on the Canvas link and then click on the CRN to log into your DL course. **NOTE:** Some courses may not be activated until the start of the term. If you cannot locate your DL course in Canvas when the term starts, contact the professor. **On the first day of classes, log into your DL course to show your "attendance" because not doing so could result in your being dropped from the class for non-attendance.**

**Professor contact info:** Email Professor Wood at either: [AWood10@mtsac.edu](mailto:AWood10@mtsac.edu), through Student Detail Schedule or Canvas at MyMtSAC Portal.

**Students must use their Mt.SAC e-mail account and be aware of course commitment and student expectations described at <http://www.mtsac.edu/distancelearning/>**

**To prepare for a successful online learning experience, see helpful short videos at <http://www.mtsac.edu/distancelearning/quiz/>**

### BUSINESS: MANAGEMENT

■ **BUSM 20 — Principles of Business** **3.0 Units**  
Degree Applicable, CSU, UC

*Prerequisite: Eligibility for ENGL 68*

Business and its functions, background, development, organization, current trends, future problems and opportunities.

10282 MW 5:10pm - 9:40pm Freeman, C 79-3280  
10312 arrange 9 hours Mc Farland, T ONLINE

**NOTE: CRN 10312 is a Distance Learning Online Class.**

**How to Begin Course:** Log into Canvas through the e-Learning Tools tab in the Mt.SAC portal at [inside.mtsac.edu](http://inside.mtsac.edu). Then click on the Canvas link and then click on the CRN to log into your DL course. **NOTE:** Some courses may not be activated until the start of the term. If you cannot locate your DL course in Canvas when the term starts, contact the professor. **On the first day of classes, log into your DL course to show your "attendance" because not doing so could result in your being dropped from the class for non-attendance.**

**Professor contact info:** Email Professor McFarland at either: [TMcFarland@mtsac.edu](mailto:TMcFarland@mtsac.edu), through Student Detail Schedule or Canvas at MyMtSAC Portal.

**Students must use their Mt.SAC e-mail account and be aware of course commitment and student expectations described at <http://www.mtsac.edu/distancelearning/>**

**To prepare for a successful online learning experience, see helpful short videos at <http://www.mtsac.edu/distancelearning/quiz/>**

■ **BUSM 61 — Business Organization and Management** **3.0 Units**  
Degree Applicable, CSU

*Advisory: BUSM 20*

Functions of management, management concepts, planning, organizing, staffing and controlling.

10314 TTh 5:10pm - 9:25pm Martinez, R 79-3280  
10340 arrange 9 hours Mc Farland, T ONLINE

**NOTE: CRN 10340 is a Distance Learning Online Class.**

**How to Begin Course:** Log into Canvas through the eLearning Tools tab in the Mt. SAC portal at [my.mtsac.edu](http://my.mtsac.edu). Then click on the Canvas link and then click on CRN for your DL course. **NOTE:** Some courses may not be activated until the start of the term. If you cannot locate your DL course in Canvas when the term starts, contact the professor.

**Professor contact info:** Email Professor McFarland at either: [TMcFarland@mtsac.edu](mailto:TMcFarland@mtsac.edu), through Student Detail Schedule or Canvas at MyMtSAC Portal.

**Students must use their Mt. SAC e-mail account and be aware of course commitment and student expectations described at <http://www.mtsac.edu/instruction/learning/distlearn/>**

■ **BUSM 62 — Human Resource Management** **3.0 Units**  
Degree Applicable

Direction of people and other functions of human resources.

10349 MW 5:10pm - 9:25pm Martinez, R 79-3280

■ **BUSM 66 — Small Business Management** **3.0 Units**  
Degree Applicable, CSU

Organizing, starting, and operating a small business enterprise.

10321 TTh 5:10pm - 9:25pm Qu, G 79-3290

### BUSINESS: REAL ESTATE

■ **BUSR 50 — Real Estate Principles** **3.0 Units**  
Degree Applicable, CSU

Real estate law. Required by the Bureau of Real Estate (BRE) for all real estate salespersons.

10332 TTh 5:10pm - 9:25pm Stephan, R 77-2070  
10557 arrange 9 hours Estes, E ONLINE

**NOTE: CRN 10557 is a Distance Learning Online Class.**

**Course Orientation:** Course orientation (optional) Thursday, June 21 from 5:30- 6:30 pm in 77-2080.

**How to Begin Course:** Log into Canvas through the e-Learning Tools tab in the Mt.SAC portal at [inside.mtsac.edu](http://inside.mtsac.edu). Then click on the Canvas link and then click on the CRN to log into your DL course. **NOTE:** Some courses may not be activated until the start of the term. If you cannot locate your DL course in Canvas when the term starts, contact the professor. **On the first day of classes, log into your DL course to show your "attendance" because not doing so could result in your being dropped from the class for non-attendance.**

**Professor contact info:** Email Professor Estes at either: [EEstes@mtsac.edu](mailto:EEstes@mtsac.edu), through Student Detail Schedule or Canvas at MyMtSAC Portal.

**Students must use their Mt.SAC e-mail account and be aware of course commitment and student expectations described at <http://www.mtsac.edu/distancelearning/>**

**To prepare for a successful online learning experience, see helpful short videos at <http://www.mtsac.edu/distancelearning/quiz/>**

## Looking for a Career in Real Estate?

*The market has turned around and values are returning to pre-recession levels!*

**Enroll today in:**

**BUSR 50**  
Real Estate Principles



*For more information please call*

**Edwin Estes**  
909-274-6428

## CHEMISTRY

**■ CHEM 10 — Chemistry for Allied Health Majors** **5.0 Units**  
 Degree Applicable, CSU, UC

*Prerequisite: Eligibility for MATH 71*

Principles of chemistry for allied health majors. Completion does not give eligibility for CHEM 50.

 10483 MTTh 7:30am - 11:20am Clements, T 7-2102  
 and MTTh 11:50am - 2:40pm Clements, T 60-3601

**NOTE:** The above CRN #10483 Lab Only: Lab does not meet on the first day June 21st. Lab does not meet on the last day, August 1st.

 10529 MTTh 7:30am - 10:40am Doshi, D 60-3601  
 and MTTh 11:20am - 3:10pm Kidane, T 7-1121

**NOTE:** The above CRN #10529 Lab Only: Lab does not meet on the first day June 21st. Lab does not meet on the last day, August 1st.

**■ CHEM 40 — Introduction to General Chemistry** **5.0 Units**  
 (C-ID CHEM 101) Degree Applicable, CSU, UC

*Prerequisite: Eligibility for MATH 71*
*Advisory: Eligibility for ENGL 1A*

Chemistry for science and engineering majors. Completion prepares students to take CHEM 50.

 10485 MTTh 7:30am - 11:20am Mahjoor, P 7-1114  
 and MTTh 11:50am - 3:00pm Mahjoor, P 60-3609

**NOTE:** The above CRN #10485 LAB ONLY: Lab does not meet the first day, June 21st. Lab does not meet the last day, August 1st.

 10488 MTTh 7:30am - 10:40am Byrne, R 60-3617  
 and MTTh 11:20am - 3:10pm Byrne, R 7

**NOTE:** The above CRN #10488 LAB ONLY: Lab does not meet the first day, June 21st. Lab does not meet the last day, August 1st.

 10530 MTTh 7:30am - 11:20am Bernard, S 7-1201  
 and MTTh 11:50am - 3:00pm Bernard, S 60-3617

**NOTE:** The above CRN #10530 LAB ONLY: Lab does not meet the first day, June 21st. Lab does not meet the last day, August 1st.

 10486 MTTh 11:30am - 3:20pm Roueintan, M 7-1114  
 and MTTh 3:50pm - 7:00pm Roueintan, M 60-3609

**NOTE:** The above CRN #10486 LAB ONLY: Lab does not meet the first day, June 21st. Lab does not meet the last day, August 1st.

 10487 MTTh 3:10pm - 7:00pm STAFF 7  
 and MTTh 7:10pm - 10:00pm STAFF 60

**NOTE:** The above CRN #10487 LAB ONLY: Lab does not meet the first day, June 21st. Lab does not meet the last day, August 1st.

## CHILD DEVELOPMENT

**■ CHLD 1 — Child, Family, School and Community** **3.0 Units**  
 (C-ID CDEV 110) Degree Applicable, CSU, UC

*Prerequisite: Eligibility for ENGL 68*

Home, child, school and community relationships in historical/contemporary perspectives regarding the socialization of children.

10344 MTW 7:30am - 10:20am Fernandez, M 73-1840

10285 TWTh 10:30am - 1:20pm Landeros, D 73-1810

10560 TWTh 1:30pm - 4:20pm Siao, M 73-1840

10345 MTW 7:30pm - 10:20pm Horwitz, E 73-1840

**■ CHLD 5 — Principles and Practices in Child Development Programs** **3.0 Units**  
 (C-ID ECE 120) Degree Applicable, CSU

Best practices for ECE teaching strategies, curriculum, environments, relationships, licensing regulations. TB clearance required.

10288 TWTh 10:30am - 1:20pm Mateo, S 73-1860

**■ CHLD 6 — Introduction to Child Development Curriculum** **3.0 Units**  
 (C-ID ECE 130) Degree Applicable, CSU

*Advisory: CHLD 5 or CHLD 10 or CHLD 10H*

Curriculum designs, content areas and environments appropriate for children birth-8 years old. TB test and observations required.

10305 TWTh 1:30pm - 4:20pm Landeros, D 73-1810

**■ CHLD 10 — Child Growth and Lifespan Development** **3.0 Units**  
 Degree Applicable, CSU, UC

Human lifespan and developmental influences. Out-of-class observations and interviews. TB test required.

10356 MTW 10:30am - 1:20pm Fernandez, M 73-1840

10287 MTW 1:30pm - 4:20pm Thay, C 73-1820

**10286 MTW 7:30pm - 10:20pm Anderson, L 73-1860**

10319 arrange 9 hours Curran, K ONLINE

**NOTE:** CRN 10319 is a **Distance Learning Online Class**.

**Other Course Requirements:** Student will do required observations on their own time.

**How to Begin Course:** Log into Canvas through the e-Learning Tools tab in the Mt.SAC portal at [inside.mtsac.edu](http://inside.mtsac.edu). Then click on the Canvas link and then click on the CRN to log into your DL course. **NOTE:** Some courses may not be activated until the start of the term. If you cannot locate your DL course in Canvas when the term starts, contact the professor. **On the first day of classes, log into your DL course to show your "attendance" because not doing so could result in your being dropped from the class for non-attendance.**
**Professor contact info:** Email Professor Curran at either: [KCurran@mtsac.edu](mailto:KCurran@mtsac.edu), through Student Detail Schedule or Canvas at MyMtSAC Portal.

**Students must use their Mt.SAC e-mail account and be aware of course commitment and student expectations described at <http://www.mtsac.edu/distancelearning/>**
**To prepare for a successful online learning experience, see helpful short videos at <http://www.mtsac.edu/distancelearning/quiz/>**
**■ CHLD 11 — Child and Adolescent Development** **3.0 Units**  
 (C-ID CDEV 100) Degree Applicable, CSU, UC

Prenatal through adolescence developmental influences. TB test, out-of-class observations and interviews required. For CD major.

10346 TWTh 7:30am - 10:20am Mateo, S 73-1860

10289 MTW 10:30am - 1:20pm Garcia-Mata, M 79-2230

**10308 MTW 4:30pm - 7:20pm Anderson, L 73-1860**
**■ CHLD 64 — Health, Safety, and Nutrition of Children** **3.0 Units**  
 (C-ID ECE 220) Degree Applicable, CSU

Laws, regulations, standards, policies, procedures, and early childhood curriculum related to child health, safety, and nutrition.

10323 MTW 10:30am - 1:20pm Thay, C 73-1820

**■ CHLD 68 — Children With Special Needs** **3.0 Units**  
 Degree Applicable, CSU

*Prerequisite: Eligibility for ENGL 68 and (CHLD 10 or CHLD 10H or CHLD 11)*

Teaching children with special needs. TB test required for off-campus observations.

10309 TWTh 4:30pm - 7:20pm Williams, R 73-1840

**■ CHLD 75 — Supervising Adults in Early Childhood Settings** **2.0 Units**  
 Degree Applicable, CSU

*Advisory: CHLD 1 and CHLD 5*

Methods and principles of working with and supervising adults in the early childhood setting.

10347 TW 7:30pm - 10:20pm Gethers, S 73-1810

# MT. SAC CHILD DEVELOPMENT COMPLEX



*A NEW place where your child can thrive!*

- Licensed for ages birth to preschool
- Meals and snacks
- Age-appropriate activities
- Quality care in a safe, stimulating environment
- Credentialed teachers/professional child development staff

**Convenient hours:**

Monday - Thursday: 7:00 a.m. - 6:00 p.m.  
 Friday: 7:00 a.m. - 5:00 p.m.

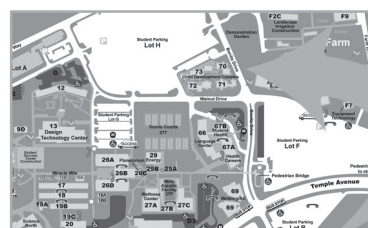

CDC is located on the corner of Bonita Drive and Walnut Drive in Buildings 70-73.  
**Call (909) 274-4920**

**CHLD 84 — Guidance and Discipline in Child Development Settings** 1.0 Unit

Degree Applicable, CSU

*Advisory: CHLD 5*

Problem solving approach to guidance and discipline of children in child development settings.

**10348 T 4:30pm - 7:20pm Jackson, L 73-1810**

**CHINESE**

**CHIN 1 — Elementary Chinese** 4.0 Units

Degree Applicable, CSU, UC

Beginning course for students without previous exposure to Mandarin Chinese.

**10231 MTWTh 10:30am - 1:20pm Chang, C 66-269**

**COMPUTER INFORMATION SYSTEMS: BEGINNING**

**CISB 11 — Computer Information Systems** 3.5 Units  
 (C-ID BUS 140)(C-ID ITIS 120) Degree Applicable, CSU, UC

Overview of computer systems, including hardware, software, networking, programming, databases, Internet, ethics and security.

**10313 MTWTh 10:00am - 12:05pm Mason, C 78-2140**  
 and **MTWTh 12:15pm - 1:20pm Mason, C 78-2140**  
**10300 MTWTh 7:00pm - 9:20pm Orefice, V 78-2140**  
 and arrange **4.5 hours Orefice, V ONLINE**

**NOTE: CRN 10300 is a Hybrid Class** taught partially online with Scheduled Meetings on Campus.

**How to Begin Course:** Log into Canvas through the e-Learning Tools tab in the Mt.SAC portal at [inside.mtsac.edu](http://inside.mtsac.edu). Then click on the Canvas link and then click on the CRN to log into your DL course. **NOTE:** Some courses may not be activated until the start of the term. If you cannot locate your DL course in Canvas when the term starts, contact the professor. **On the first day of classes, log into your DL course to show your "attendance" because not doing so could result in your being dropped from the class for non-attendance.**

**Professor contact info:** Email Professor [vquintana@mtsac.edu](mailto:vquintana@mtsac.edu) at either: [vquintana@mtsac.edu](mailto:vquintana@mtsac.edu), through Student Detail Schedule or Canvas at MyMtSAC Portal.

**Students must use their Mt.SAC e-mail account and be aware of course commitment and student expectations described at <http://www.mtsac.edu/distancelearning/>**

**To prepare for a successful online learning experience, see helpful short videos at <http://www.mtsac.edu/distancelearning/quiz/>**

# COMPUTER SKILLS FOR LIFE!

Learn how *hardware, software* and *Internet basics* can empower you with *lifelong skills*.

Enroll in **Computer Information Systems-CIS**

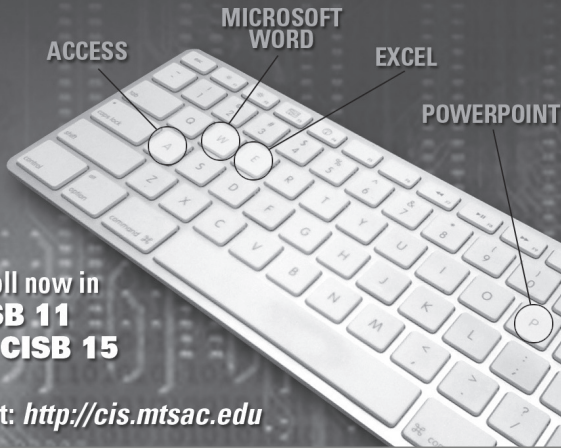

Enroll now in  
**CISB 11**  
and **CISB 15**

Visit: <http://cis.mtsac.edu>

10301            arrange        9 hours    Blyzka, J            ONLINE  
                  and arrange    4.5 hours   Blyzka, J            ONLINE

**NOTE:** CRN 10301 is a **Hybrid Class** taught partially online with Scheduled Meetings on Campus.

**How to Begin Course:** Log into Canvas through the e-Learning Tools tab in the Mt.SAC portal at [inside.mtsac.edu](http://inside.mtsac.edu). Then click on the Canvas link and then click on the CRN to log into your DL course. **NOTE:** Some courses may not be activated until the start of the term. If you cannot locate your DL course in Canvas when the term starts, contact the professor. **On the first day of classes, log into your DL course to show your "attendance" because not doing so could result in your being dropped from the class for non-attendance.**

**Professor contact info:** Email Professor jbyzka@mtsac.edu at either: [jbyzka@mtsac.edu](mailto:jbyzka@mtsac.edu), through Student Detail Schedule or Canvas at MyMtSAC Portal.

**Students must use their Mt.SAC e-mail account and be aware of course commitment and student expectations described at <http://www.mtsac.edu/distancelearning/>**

**To prepare for a successful online learning experience, see helpful short videos at <http://www.mtsac.edu/distancelearning/quiz/>**

10302            arrange        9 hours    Andrews, B            ONLINE  
                  and arrange    4.5 hours   Andrews, B            ONLINE

**NOTE:** CRN 10302 is a **Hybrid Class** taught partially online with Scheduled Meetings on Campus.

**How to Begin Course:** Log into Canvas through the e-Learning Tools tab in the Mt.SAC portal at [inside.mtsac.edu](http://inside.mtsac.edu). Then click on the Canvas link and then click on the CRN to log into your DL course. **NOTE:** Some courses may not be activated until the start of the term. If you cannot locate your DL course in Canvas when the term starts, contact the professor. **On the first day of classes, log into your DL course to show your "attendance" because not doing so could result in your being dropped from the class for non-attendance.**

**Professor contact info:** Email Professor bandrews@mtsac.edu at either: [bandrews@mtsac.edu](mailto:bandrews@mtsac.edu), through Student Detail Schedule or Canvas at MyMtSAC Portal.

**Students must use their Mt.SAC e-mail account and be aware of course commitment and student expectations described at <http://www.mtsac.edu/distancelearning/>**

**To prepare for a successful online learning experience, see helpful short videos at <http://www.mtsac.edu/distancelearning/quiz/>**

## ■ CISB 15 — Microcomputer Applications 3.5 Units Degree Applicable, CSU, UC

Windows OS and applications: word processing, spreadsheet, database management and presentation software.

10318	MTWTh	8:00am - 10:05am	Erbe, C	78-2120
and	MTWTh	10:15am - 11:20am	Erbe, C	78-2120
10325	MTWTh	7:15pm - 8:05pm	Zelaya, G	78-2120
and	MTWTh	8:15pm - 9:20pm	Zelaya, G	78-2120
	and arrange	6 hours	Zelaya, G	ONLINE

**NOTE:** CRN 10325 is a **Hybrid Class** taught partially online with Scheduled Meetings on Campus.

**How to Begin Course:** Log into Canvas through the e-Learning Tools tab in the Mt.SAC portal at [inside.mtsac.edu](http://inside.mtsac.edu). Then click on the Canvas link and then click on the CRN to log into your DL course. **NOTE:** Some courses may not be activated until the start of the term. If you cannot locate your DL course in Canvas when the term starts, contact the professor. **On the first day of classes, log into your DL course to show your "attendance" because not doing so could result in your being dropped from the class for non-attendance.**

**Professor contact info:** Email Professor gzelaya@mtsac.edu at either: [gzelaya@mtsac.edu](mailto:gzelaya@mtsac.edu), through Student Detail Schedule or Canvas at MyMtSAC Portal.

**Students must use their Mt.SAC e-mail account and be aware of course commitment and student expectations described at <http://www.mtsac.edu/distancelearning/>**

**To prepare for a successful online learning experience, see helpful short videos at <http://www.mtsac.edu/distancelearning/quiz/>**

10303	arrange	9 hours	Degtyareva, A	ONLINE
	and arrange	4.5 hours	Degtyareva, A	ONLINE

**NOTE:** CRN 10303 is a **Distance Learning Online Class**.

**How to Begin Course:** Log into Canvas through the e-Learning Tools tab in the Mt.SAC portal at [inside.mtsac.edu](http://inside.mtsac.edu). Then click on the Canvas link and then click on the CRN to log into your DL course. **NOTE:** Some courses may not be activated until the start of the term. If you cannot locate your DL course in Canvas when the term starts, contact the professor. **On the first day of classes, log into your DL course to show your "attendance" because not doing so could result in your being dropped from the class for non-attendance.**

**Professor contact info:** Email Professor adegtyareva@mtsac.edu at either: [adegtyareva@mtsac.edu](mailto:adegtyareva@mtsac.edu), through Student Detail Schedule or Canvas at MyMtSAC Portal.

**Students must use their Mt.SAC e-mail account and be aware of course commitment and student expectations described at <http://www.mtsac.edu/distancelearning/>**

**To prepare for a successful online learning experience, see helpful short videos at**

**<http://www.mtsac.edu/distancelearning/quiz/>**

10304	arrange	9 hours	Blyzka, J	ONLINE
	and arrange	4.5 hours	Blyzka, J	ONLINE

**NOTE:** CRN 10304 is a **Distance Learning Online Class**.

**How to Begin Course:** Log into Canvas through the e-Learning Tools tab in the Mt.SAC portal at [inside.mtsac.edu](http://inside.mtsac.edu). Then click on the Canvas link and then click on the CRN to log into your DL course. **NOTE:** Some courses may not be activated until the start of the term. If you cannot locate your DL course in Canvas when the term starts, contact the professor. **On the first day of classes, log into your DL course to show your "attendance" because not doing so could result in your being dropped from the class for non-attendance.**

**Professor contact info:** Email Professor jbyzka@mtsac.edu at either: [jbyzka@mtsac.edu](mailto:jbyzka@mtsac.edu), through Student Detail Schedule or Canvas at MyMtSAC Portal.

**Students must use their Mt.SAC e-mail account and be aware of course commitment and student expectations described at <http://www.mtsac.edu/distancelearning/>**

**To prepare for a successful online learning experience, see helpful short videos at <http://www.mtsac.edu/distancelearning/quiz/>**

**COMPUTER INFORMATION SYSTEMS: PROGRAMMING****■ CISP 41 — Programming in C#** **3.0 Units**  
Degree Applicable, CSU*Corequisite: CISP 41L**Advisory: CISP 10 and CISB 11 and CISB 15*

Programming in C# covers Windows Forms, Web Forms, control structures, database access. Student must take CISP 41L concurrently.

10350 MTWTh 10:00am - 12:05pm Zaki, S 79-2260

**NOTE:** CISP41 (CRN 10350) is linked to CISP41L (CRN 10351). If you are interested in enrolling in these courses, you must enter both CRN's (10351 and 10350) to register.**■ CISP 41L — Programming in C# Laboratory** **.5 Unit**  
Degree Applicable, CSU*Corequisite: CISP 41*

Programming lab in C# covers Windows Forms, Web Forms, control structures, database access. Student must take CISP 41 concurrently

10351 MTWTh 12:15pm - 1:20pm Zaki, S 79-2260

**NOTE:** CISP41L (CRN 10351) is linked to CISP41 (CRN 10350). If you are interested in enrolling in these courses, you must enter both CRN's (10351 and 10350) to register.**COMPUTER SCIENCE****■ CSCI 190 — Discrete Mathematics Applied to Computer Science** **4.0 Units**  
Degree Applicable, CSU, UC*Prerequisite: MATH 71 or equivalent*

Mathematics for computer science such as logic, proof techniques, sets, recursions, trees, and graphs.

10478 MTWTh 7:30pm - 10:20pm Young, G 61-2315

**COMPUTER AND NETWORKING TECHNOLOGY****■ CNET 60 — A+ Certification Preparation** **2.0 Units**  
Degree Applicable*Advisory: CNET 50 and CNET 52*

Preparation for A+ certification examination, including all aspects of the Essentials and Practical Application test modules.

10002 TWTh 8:00am - 9:50am Miller, K 28B-404

**■ CNET 62 — Network+ Certification Preparation** **2.0 Units**  
Degree Applicable*Advisory: CNET 56*

Prepares students for the Network+ certification examination. Includes OSI model, TCP/IP, and network administration.

10656 TWTh 10:00am - 11:50am Miller, K 28B-404

**COUNSELING****■ COUN 1 — Introduction to College** **1.0 Unit**  
Degree Applicable, CSU, UC

(May be taken for Pass/No Pass Only)

Higher education and the college experience including educational decision-making and educational planning.

10824 MW 8:30am - 9:45am Bachor, A 12-1020

**NOTE:** CRN 10824 above is designed for students in the Summer Bridge Program. Special approval is needed to enroll in this learning community. For more information, please contact (909)274-5392.

10825 MW 8:30am - 9:45am Ton, C 12-1060

**NOTE:** CRN 10825 above is designed for students in the Summer Bridge Program. Special approval is needed to enroll in this learning community. For more information, please contact (909)274-5392.

10827 MW 8:30am - 9:45am Hart, J 12-1080

**NOTE:** CRN 10827 above is designed for students in the Summer Bridge Program. Special approval is needed to enroll in this learning community. For more information, please contact (909)274-5392.

10828 MW 8:30am - 9:45am Ngo, M 21A-1

**NOTE:** CRN 10828 above is designed for students in the Summer Bridge Program. Special approval is needed to enroll in this learning community. For more information, please contact (909)274-5392.

10829 TTh 8:30am - 9:45am Flamenno, B 12-1020

**NOTE:** CRN 10829 above is designed for students in the Summer Bridge Program. Special approval is needed to enroll in this learning community. For more information, please contact (909)274-5392.

10830 TTh 8:30am - 9:45am Lee, E 12-1060

**NOTE:** CRN 10830 above is designed for students in the Summer Bridge Program. Special approval is needed to enroll in this learning community. For more information, please contact (909)274-5392.

10831 TTh 8:30am - 9:45am Espinoza, L 12-1080

**NOTE:** CRN 10831 above is designed for students in the Summer Bridge Program. Special approval is needed to enroll in this learning community. For more information, please contact (909)274-5392.

10832 TTh 8:30am - 9:45am Santacruz, R 21A-1

**NOTE:** CRN 10832 above is designed for students in the Summer Bridge Program. Special approval is needed to enroll in this learning community. For more information, please contact (909)274-5392.10746 MTWTh 10:30am - 12:45pm Cuevas-Arella, A 12-1020  
**2 Weeks, Week beginning 06/25/2018 ending 07/05/2018****NOTE:** CRN 10746 above is designed for first time college students who recently graduated from high school. To enroll in the STEP Program, students must attend an information and registration meeting. Please see the STEP website at [www.mtsac.edu/step](http://www.mtsac.edu/step) to sign up for this meeting. Special Approval is needed to enroll in this 2 week course. For more information about the STEP Program, please email [STEP@mtsac.edu](mailto:STEP@mtsac.edu).10747 MTWTh 10:30am - 12:45pm Versace, E 12-1060  
**2 Weeks, Week beginning 06/25/2018 ending 07/05/2018****NOTE:** CRN 10747 above is designed for first time college students who recently graduated from high school. To enroll in the STEP Program, students must attend an information and registration meeting. Please see the STEP website at [www.mtsac.edu/step](http://www.mtsac.edu/step) to sign up for this meeting. Special Approval is needed to enroll in this 2 week course. For more information about the STEP Program, please email [STEP@mtsac.edu](mailto:STEP@mtsac.edu).10748 MTWTh 10:30am - 12:45pm Hayward, J 12-1080  
**2 Weeks, Week beginning 06/25/2018 ending 07/05/2018****NOTE:** CRN 10748 above is designed for first time college students who recently graduated from high school. To enroll in the STEP Program, students must attend an information and registration meeting. Please see the STEP website at [www.mtsac.edu/step](http://www.mtsac.edu/step) to sign up for this meeting. Special Approval is needed to enroll in this 2 week course. For more information about the STEP Program, please email [STEP@mtsac.edu](mailto:STEP@mtsac.edu).10749 MTWTh 10:30am - 12:30pm Gutierrez, D 12-1020  
**2 Weeks, Week beginning 07/09/2018 ending 07/19/2018****NOTE:** CRN 10749 above is designed for first time college students who recently graduated from high school. To enroll in the STEP Program, students must attend an information and registration meeting. Please see the STEP website at [www.mtsac.edu/step](http://www.mtsac.edu/step) to sign up for this meeting. Special Approval is needed to enroll in this 2 week course. For more information about the STEP Program, please email [STEP@mtsac.edu](mailto:STEP@mtsac.edu).10750 MTWTh 10:30am - 12:30pm Versace, E 12-1060  
**2 Weeks, Week beginning 07/09/2018 ending 07/19/2018****NOTE:** CRN 10750 above is designed for first time college students who recently graduated from high school. To enroll in the STEP Program, students must attend an information and registration meeting. Please see the STEP website at [www.mtsac.edu/step](http://www.mtsac.edu/step) to sign up for this meeting. Special Approval is needed to enroll in this 2 week course. For more information about the STEP Program, please email [STEP@mtsac.edu](mailto:STEP@mtsac.edu).10751 MTWTh 10:30am - 12:30pm Hayward, J 12-1080  
**2 Weeks, Week beginning 07/09/2018 ending 07/19/2018****NOTE:** CRN 10751 above is designed for first time college students who recently graduated from high school. To enroll in the STEP Program, students must attend an information and registration meeting. Please see the STEP website at [www.mtsac.edu/step](http://www.mtsac.edu/step) to sign up for this meeting. Special Approval is needed to enroll in this 2 week course. For more information about the STEP Program, please email [STEP@mtsac.edu](mailto:STEP@mtsac.edu).

# Don't waste Your Time or Money



- Take the right classes
- Figure out your career path
- Earn transferable units

## REGISTER FOR:

Coun1 - Introduction to College • Coun2 - College Success Strategies  
Coun5 - Career/Life Planning • Coun7 - Introduction to the Transfer Process  
Lead 55- Exploring Leadership • Coun 51-Career Planning

[www.mtsac.edu/counseling/courses.html](http://www.mtsac.edu/counseling/courses.html)

### ■ COUN 2 — College Success Strategies 3.0 Units

Degree Applicable, CSU, UC

(May be taken for option of Letter grade or Pass/NoPass)

Strategies and techniques to be an effective college student and achieve educational and career goals.

10752 MTWTh 10:00am - 12:05pm Hart, J 21A-1

### ■ COUN 5 — Career and Life Planning 3.0 Units

Degree Applicable, CSU

*Prerequisite:* Eligibility for ENGL 68

*Advisory:* Eligibility for AMLA 33R or Eligibility for READ 90

Explore and evaluate career options using a systematic approach to self-exploration, career, and life planning.

10755 MTWTh 8:00am - 10:05am Torres, A 21I-1

10753 TW 7:15pm - 9:20pm Mbuthi, S 12-1060  
and arrange 4.9 hours Mbuthi, S ONLINE

**NOTE:** CRN 10753 is a Hybrid Class taught partially online with Scheduled Meetings on Campus.

**Other Course Requirements:** Modern computer with internet connection required.

**How to Begin Course:** Log into Canvas through the e-Learning Tools tab in the Mt.SAC portal at [inside.mtsac.edu](http://inside.mtsac.edu). Then click on the Canvas link and then click on the CRN to log into your DL course. **NOTE:** Some courses may not be activated until the start of the term. If you cannot locate your DL course in Canvas when the term starts, contact the professor.

**Professor contact info:** Email Professor Mbuthi at either: [smbuthi@mtsac.edu](mailto:smbuthi@mtsac.edu), through Student Detail Schedule or Canvas at MyMtSAC Portal.

**Students must use their Mt.SAC e-mail account and be aware of course commitment and student expectations described at <http://www.mtsac.edu/distancelearning/>**

**To prepare for a successful online learning experience, see helpful short videos at <http://www.mtsac.edu/distancelearning/quiz/>**

10754 Th 06/21 7:15pm - 9:20pm Mbuthi, S 12-1060  
and arrange 9 hours Mbuthi, S ONLINE

**NOTE:** CRN 10754 is a Hybrid Class taught partially online with one Scheduled Meeting on Campus.

**Course Orientation:** Course orientation schedule above is mandatory. If student cannot attend orientation, student must contact professor before orientation meeting to avoid being dropped from class.

**Other Course Requirements:** Modern computer with internet connection required.

**How to Begin Course:** Log into Canvas through the e-Learning Tools tab in the Mt.SAC portal at [inside.mtsac.edu](http://inside.mtsac.edu). Then click on the Canvas link and then click on the CRN to log into your DL course. **NOTE:** Some courses may not be activated until the start of the term. If you cannot locate your DL course in Canvas when the term starts, contact the professor.

**Professor contact info:** Email Professor Mbuthi at either: [smbuthi@mtsac.edu](mailto:smbuthi@mtsac.edu), through Student Detail Schedule or Canvas at MyMtSAC Portal.

**Students must use their Mt.SAC e-mail account and be aware of course commitment and student expectations described at <http://www.mtsac.edu/distancelearning/>**

**To prepare for a successful online learning experience, see helpful short videos at <http://www.mtsac.edu/distancelearning/quiz/>**

## DANCE: ACTIVITY

### ■ DNCE 2A — Ballet I .5 Unit

Degree Applicable, CSU, UC

(May be taken for option of Letter grade or Pass/NoPass)

Beginning vocabulary, technique, and movement combinations for ballet.

11056 MW 10:30am - 1:20pm Lee, F 2-T122

**NOTE:** CRN 11056: No-cost digital textbooks or textual materials used.

**■ DNCE 2B — Ballet II** **.5 Unit**  
Degree Applicable, CSU, UC

(May be taken four times for credit)  
(May be taken for option of Letter grade or Pass/NoPass)  
Intermediate technique, vocabulary, and movement combinations of ballet.

11057 MW 10:30am - 1:20pm Lee, F 2-T122  
**NOTE:** CRN 11057: No-cost digital textbooks or textual materials used.

**■ DNCE 10 — Modern Fundamentals** **.5 Unit**  
Degree Applicable, CSU, UC

(May be taken for option of Letter grade or Pass/NoPass)  
Fundamental vocabulary, technique, and movement combinations for Modern Dance.

11058 MW 1:30pm - 4:20pm Lee, F 2-T121  
**NOTE:** CRN 11058: No-cost digital textbooks or textual materials used.

**■ DNCE 11A — Social Dance Forms I** **.5 Unit**  
Degree Applicable, CSU, UC

(May be taken for option of Letter grade or Pass/NoPass)  
Dance positions, steps, formations, and choreography of social dance techniques.

11060 TTh 1:30pm - 4:20pm Hendrix, J 2-T121  
**NOTE:** CRN 11060: No-cost digital textbooks or textual materials used.

**■ DNCE 11B — Social Dance Forms II** **.5 Unit**  
Degree Applicable, CSU, UC

(May be taken for option of Letter grade or Pass/NoPass)  
Advanced dance positions, formations, music and choreography of social dance techniques.

11061 TTh 1:30pm - 4:20pm Hendrix, J 2-T121  
**NOTE:** CRN 11061: No-cost digital textbooks or textual materials used.

**■ DNCE 12A — Modern I** **.5 Unit**  
Degree Applicable, CSU, UC

(May be taken for option of Letter grade or Pass/NoPass)  
Beginning terminology, technique, and movement combinations for Modern dance.

11062 TTh 10:30am - 1:20pm Estrada-Romero, J 2-T121  
**NOTE:** CRN 11062: No-cost digital textbooks or textual materials used.

11059 MW 1:30pm - 4:20pm Lee, F 2-T121  
**NOTE:** CRN 11059: No-cost digital textbooks or textual materials used.

**■ DNCE 12B — Modern II** **.5 Unit**  
Degree Applicable, CSU, UC

(May be taken for option of Letter grade or Pass/NoPass)  
Intermediate terminology, technique, and movement combinations for Modern dance.

11063 TTh 10:30am - 1:20pm Estrada-Romero, J 2-T121  
**NOTE:** CRN 11063: No-cost digital textbooks or textual materials used.

**■ DNCE 14A — Jazz I** **.5 Unit**  
Degree Applicable, CSU, UC

(May be taken for option of Letter grade or Pass/NoPass)  
Beginning vocabulary, technique, and movement combinations for jazz dance.

11064 TTh 1:30pm - 4:20pm Estrada-Romero, J 2-T122  
**NOTE:** CRN 11064: No-cost digital textbooks or textual materials used.

**■ DNCE 14B — Jazz II** **.5 Unit**  
Degree Applicable, CSU, UC

(May be taken for option of Letter grade or Pass/NoPass)  
Intermediate vocabulary, technique, and movement combinations for jazz dance.

11065 TTh 1:30pm - 4:20pm Estrada-Romero, J TBA  
**NOTE:** CRN 11065: No-cost digital textbooks or textual materials used.

**■ DNCE 32 — Commercial Dance** **.5 Unit**  
Degree Applicable, CSU, UC

(May be taken for option of Letter grade or Pass/NoPass)  
Beginning terminology, styles, and choreography of Hip Hop dance.

11066 MW 7:30pm - 10:20pm STAFF 2-T121  
**NOTE:** CRN 11066: No-cost digital textbooks or textual materials used.

**■ DNCE 36 — Commercial Dance II** **.5 Unit**  
Degree Applicable, CSU, UC

(May be taken for option of Letter grade or Pass/NoPass)  
Styles and choreography of Hip Hop dance.

11067 MW 7:30pm - 10:20pm STAFF 2-T121  
**NOTE:** CRN 11067: No-cost digital textbooks or textual materials used.

**■ DNCE 39A — Alignment and Correctives I** **.5 Unit**  
Degree Applicable, CSU, UC

(May be taken for option of Letter grade or Pass/NoPass)  
Pilates method of conditioning (mat and Reformer).

11069 MW 7:00pm - 9:50pm Ritz, K 45-1411  
**NOTE:** CRN 11069: No-cost digital textbooks or textual materials used.

**■ DNCE 40 — Conditioning Through Dance** **.5 Unit**  
Degree Applicable, CSU, UC

(May be taken for option of Letter grade or Pass/NoPass)  
Improves fitness through the coordination of dance exercises. Focuses on strength, flexibility, and range of motion.

11070 MW 4:00pm - 6:50pm Ritz, K 45-1411  
**NOTE:** CRN 11070: No-cost digital textbooks or textual materials used.

### DANCE: THEORY

**■ DN-T 20 — History and Appreciation of Dance** **3.0 Units**  
Degree Applicable, CSU, UC

*Advisory: Eligibility for ENGL 68*

Survey of theatrical dance in western civilization.

11068 TWTh 10:30am - 1:20pm Hendrix, J TBA

### DISABLED STUDENTS

**■ DSPS 13 — Orientation to College for Students with Disabilities** **1.0 Unit**

Not Degree Applicable

(May be taken for option of Letter grade or Pass/NoPass)

Examine the college experience in relationship to disabilities.

10558 MW 9:00am - 10:15am Reyes, E 9E-1060

**■ DSPS 34 — Writing Strategies** **3.0 Units**  
Not Degree Applicable

(May be taken for Pass/No Pass Only)

*Prerequisite: Eligibility for ENGL 67*

Strategies for success for students who struggle with writing concurrently enrolled in ENGL 67-1C classes.

10559 TWTh 1:30pm - 4:20pm Lee, B 9E-1060

### EMERGENCY MEDICAL SERVICE

**■ EMS 1 — Paramedic Fundamentals and Selection** **4.0 Units**  
Degree Applicable

*Prerequisite: Completed Paramedic Program application, current California EMT I (Basic) certificate, and 1200 hours employment as an EMT I, Eligibility for ENGL 68, Eligibility for READ 90, and Eligibility for MATH 51*

Assessment and review of EMT competencies and mathematical skills as part of the selection process for EMT - P program.

10053 MTWTh 8:00am - 11:50am Rincon, P 28B-212  
and MTWTh 1:00pm - 4:50pm Jabr, A 28B-212

**3 Weeks, Week beginning 06/21/2018 ending 07/12/2018**

■ **EMS 2 — Preparation for Paramedic Program** **1.0 Unit**  
Not Degree Applicable

(May be taken for Pass/No Pass Only)

*Prerequisite:* Acceptance into the paramedic program AND EMS 1

EMT-Basic Skills development for patient assessment and treatment decisions. 911 response team ride-alongs highly recommended.

10054	MTWTh	8:00am - 11:50am	STAFF	28B-201
and	MTWTh	1:00pm - 3:30pm	STAFF	28B-201

**2 Weeks, Week beginning 07/16/2018 ending 07/29/2018**

■ **EMS 70 — Paramedic Clinical Internship** **3.0 Units**  
Degree Applicable

(May be taken for Pass/No Pass Only)

*Prerequisite:* EMS 10 and EMS 20 and EMS 30 and EMS 40 and EMS 50 and EMS 60

Clinical experience and application of paramedic theory and practice, patient assessment, and skills in a hospital setting.

11093	arrange	27 hours	Rincon, P	HOSP
-------	---------	----------	-----------	------

## ENGINEERING

■ **ENGR 8 — Properties of Materials** **4.0 Units**  
Degree Applicable, CSU, UC

*Prerequisite:* (CHEM 40 or CHEM 50) and (PHYS 4A or PHYS 2AG)

Mechanical, electrical, magnetic, optical, and thermal properties of engineering materials.

10684	MTWTh	1:30pm - 4:20pm	Tseng, T	TBA
-------	-------	-----------------	----------	-----

■ **ENGR 18 — Introduction to Engineering Graphics** **3.0 Units**  
Degree Applicable, CSU

Fundamentals of engineering graphics and problem solving techniques.

10680	TWTh	7:30am - 9:35am	Khan, M	11-2107
and	TWTh	9:45am - 12:50pm	Khan, M	11-2107

■ **ENGR 40 — Statics** **3.0 Units**  
Degree Applicable, CSU, UC

*Prerequisite:* PHYS 4A and MATH 181

Vector approach to static equilibrium of rigid bodies, forces, couples in two and three-dimensional space.

10681	MTWTh	10:30am - 12:35pm	Afrasiabi, J	11-2101
-------	-------	-------------------	--------------	---------

■ **ENGR 42 — Mechanics of Materials** **4.0 Units**  
Degree Applicable, CSU, UC

*Prerequisite:* ENGR 40

Mechanics of deformable bodies subjected to axial, torsional, shearing, and bending loads.

10682	MTWTh	7:30am - 10:20am	Purasinghe, R	11-2101
-------	-------	------------------	---------------	---------

■ **ENGR 50A — Robotics Team Project Development** **2.0 Units**  
Degree Applicable, CSU

(May be taken four times for credit)

*Prerequisite:* Instructor approval required for robotics competition team members

This course is for members of the Robotics Team. Instructor Approval required. Off-campus competition required.

10683	F	8:00am - 3:30pm	Mason, M	60-1506
		and arrange 10.2 hours	Mason, M	

**6 Weeks, Week beginning 06/21/2018 ending 08/01/2018**

## ENGINEERING DESIGN TECHNOLOGY

■ **EDT 89 — Engineering Design Technology Work Experience** **1.0 Unit**  
Degree Applicable

(May be taken for Pass/No Pass Only)

*Prerequisite:* Application approved by department faculty and compliance with Work Experience regulations as designated in the College Catalog

10062	arrange	12.5 hours	James, S	18C
-------	---------	------------	----------	-----

**NOTE:** Special Approval required. Please contact Rachael Brown at 909-274-5675 or in person in 18-C.

■ **EDT 89 — Engineering Design Technology Work Experience** **2.0 Units**  
Degree Applicable

(May be taken for Pass/No Pass Only)

*Prerequisite:* Application approved by department faculty and compliance with Work Experience regulations as designated in the College Catalog

10063	arrange	25 hours	James, S	18C
-------	---------	----------	----------	-----

**NOTE:** Special Approval required. Please contact Rachael Brown at 909-274-5675 or in person in 18-C.

## ENGLISH: COMPOSITION

■ **ENGL 1A — Freshman Composition** **4.0 Units**  
(C-ID ENGL 100) Degree Applicable, CSU, UC

*Prerequisite:* ENGL 68 or satisfactory score on the English Placement Test  
Develops expository and argumentative essay and research paper skills. Emphasizes critical reading of academic material.

10092	MTWTh	7:30am - 10:20am	Gomez, F	26A-3670
-------	-------	------------------	----------	----------

**NOTE: No cost digital textbooks or textual materials used.**

10093	MTWTh	7:30am - 10:20am	Harper, M	26A-3881
10094	MTWTh	7:30am - 10:20am	Ramos, C	26D-3491
10095	MTWTh	7:30am - 10:20am	Lee, B	26D-3481
10273	MTWTh	7:30am - 10:20am	Betkey, C	26D-2210
10277	MTWTh	7:30am - 10:20am	Perez Gonzalez, J	26A-3891
10606	MTWTh	7:30am - 10:20am	Garavito, C	26A-3620
10607	MTWTh	7:30am - 10:20am	Cascella, H	26A-1871
10608	MTWTh	7:30am - 10:20am	Lampert, K	26A-3871
10096	TTh	7:30am - 10:20am	McFaul, J	26D-3280

and arrange 6.25 hours  
**NOTE: CRN 10096 is a Hybrid Class** taught partially online with Scheduled Meetings on Campus.

**How to Begin Course:** Log into Canvas through the e-Learning Tools tab in the Mt.SAC portal at [inside.mtsac.edu](http://inside.mtsac.edu). Then click on the Canvas link and then click on the CRN to log into your DL course. **NOTE:** Some courses may not be activated until the start of the term. If you cannot locate your DL course in Canvas when the term starts, contact the professor. **On the first day of classes, log into your DL course to show your "attendance" because not doing so could result in your being dropped from the class for non-attendance.**

**Professor contact info:** Email Professor McFaul at either: [JDMcFaul@mtsac.edu](mailto:JDMcFaul@mtsac.edu), through Student Detail Schedule or Canvas at MyMt-SAC Portal.

**Students must use their Mt.SAC e-mail account and be aware of course commitment and student expectations described at <http://www.mtsac.edu/distancelearning/>**

**To prepare for a successful online learning experience, see helpful short videos at <http://www.mtsac.edu/distancelearning/quiz/>**

10097	MTWTh	10:30am - 1:20pm	Gomez, F	26A-3670
-------	-------	------------------	----------	----------

**NOTE:** CRN 10097 above is designed for students in the Summer Bridge Program. Special approval is needed to enroll in this learning community. For more information, please contact (909)274-5392.

**No cost digital textbooks or textual materials used.**

10172	MTWTh	10:30am - 1:20pm	Harper, M	26A-3881
-------	-------	------------------	-----------	----------



## ENGLISH COURSE SEQUENCE: IF ENGLISH IS YOUR PRIMARY LANGUAGE

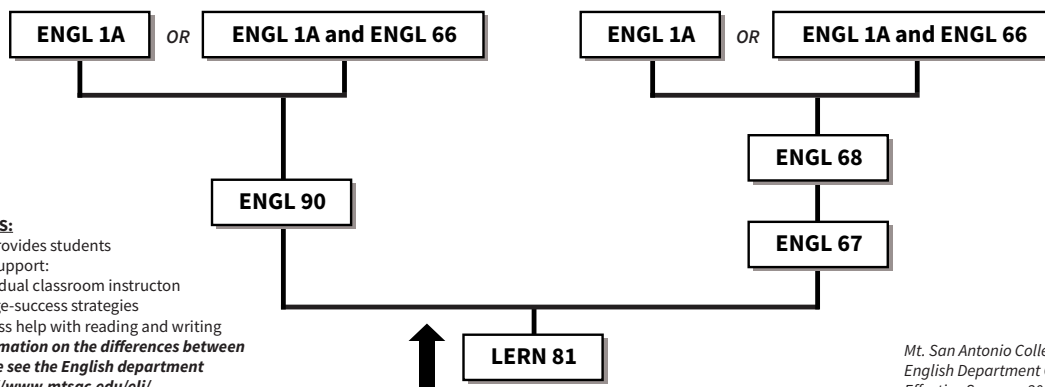

**COURSE NOTES:**

ENGL 66 (80) provides students the following support:

- More individual classroom instruction
- More college-success strategies
- More in-class help with reading and writing

For more information on the differences between courses, please see the English department website: <http://www.mtsac.edu/elj/>

Mt. San Antonio College  
English Department Course Flow Chart  
Effective Summer 2018

Where a student begins the sequence is determined by placement results from the online Assessment Questionnaire (using high school GPA) or the writing placement test.

10609	MTWTh	10:30am - 1:20pm	Karn, T	26D-2210
10611	MTWTh	10:30am - 1:20pm	Daigre, V	26A-3620
10612	MTWTh	10:30am - 1:20pm	Flores, C	26A-3871
10613	MTWTh	10:30am - 1:20pm	Joshua, S	26D-3491
10614	MTWTh	10:30am - 1:20pm	Stefan, J	26B-3565
10615	MTWTh	10:30am - 1:20pm	Brandler, M	26A-1871
10616	MTWTh	10:30am - 1:20pm	Wright, S	26D-G220
10617	MTWTh	10:30am - 1:20pm	Sanchez, C	26B-3555
10618	MTWTh	10:30am - 1:20pm	Reichert, N	26D-3411
10619	MTWTh	10:30am - 1:20pm	Staylor, D	26D-3471
10620	MTWTh	10:30am - 1:20pm	Gonzalez, M	26D-3290
10156	MW	10:30am - 1:20pm	Alvarez, H	26D-3481

10610	TTh	10:30am - 1:20pm	Arterburn, P	26D-3481
		and arrange 6.25 hours	Arterburn, P	ONLINE

**NOTE: CRN 10610 is a Hybrid Class** taught partially online with Scheduled Meetings on Campus.

**How to Begin Course:** Log into Canvas through the e-Learning Tools tab in the Mt.SAC portal at [inside.mtsac.edu](http://inside.mtsac.edu). Then click on the Canvas link and then click on the CRN to log into your DL course. **NOTE:** Some courses may not be activated until the start of the term. If you cannot locate your DL course in Canvas when the term starts, contact the professor. **On the first day of classes, log into your DL course to show your "attendance" because not doing so could result in your being dropped from the class for non-attendance.**

**Professor contact info:** Email Professor Arterburn at either: PArterburn@mtsac.edu, through Student Detail Schedule or Canvas at MyMt-SAC Portal.

**Students must use their Mt.SAC e-mail account and be aware of course commitment and student expectations described at <http://www.mtsac.edu/distancelearning/>**

**To prepare for a successful online learning experience, see helpful short videos at <http://www.mtsac.edu/distancelearning/quiz/>**

10173	MTWTh	1:30pm - 4:20pm	Straw, E	26A-3680
10174	MTWTh	1:30pm - 4:20pm	Hight, L	26A-3831
10175	MTWTh	1:30pm - 4:20pm	Chandler, G	26A-3610
10275	MTWTh	1:30pm - 4:20pm	Hight, J	26A-3841
10621	MTWTh	1:30pm - 4:20pm	Karn, T	26D-2210
10622	MTWTh	1:30pm - 4:20pm	Redmon, P	26A-1871
10212	MW	1:30pm - 4:20pm	Alvarez, H	26D-3481

**NOTE: CRN 10212 is a Hybrid Class** taught partially online with Scheduled Meetings on Campus.

**How to Begin Course:** Log into Canvas through the e-Learning Tools tab in the Mt.SAC portal at [inside.mtsac.edu](http://inside.mtsac.edu). Then click on the Canvas link and then click on the CRN to log into your DL course. **NOTE:** Some courses may not be activated until the start of the term. If you cannot locate your DL course in Canvas when the term starts, contact the professor. **On the first day of classes, log into your DL course to show your "attendance" because not doing so could result in your being dropped from the class for non-attendance.**

**Professor contact info:** Email Professor Alvarez at either: HALvarez@mtsac.edu, through Student Detail Schedule or Canvas at MyMtSAC Portal.

**Students must use their Mt.SAC e-mail account and be aware of course commitment and student expectations described at <http://www.mtsac.edu/distancelearning/>**

**To prepare for a successful online learning experience, see helpful short videos at <http://www.mtsac.edu/distancelearning/quiz/>**

**No cost digital textbooks or textual materials used.**

**NOTE: CRN 10156 is a Hybrid Class** taught partially online with Scheduled Meetings on Campus.

**How to Begin Course:** Log into Canvas through the e-Learning Tools tab in the Mt.SAC portal at [inside.mtsac.edu](http://inside.mtsac.edu). Then click on the Canvas link and then click on the CRN to log into your DL course. **NOTE:** Some courses may not be activated until the start of the term. If you cannot locate your DL course in Canvas when the term starts, contact the professor. **On the first day of classes, log into your DL course to show your "attendance" because not doing so could result in your being dropped from the class for non-attendance.**

**Professor contact info:** Email Professor Alvarez at either: HALvarez@mtsac.edu, through Student Detail Schedule or Canvas at MyMtSAC Portal.

**Students must use their Mt.SAC e-mail account and be aware of course commitment and student expectations described at <http://www.mtsac.edu/distancelearning/>**

**To prepare for a successful online learning experience, see helpful short videos at <http://www.mtsac.edu/distancelearning/quiz/>**

**No cost digital textbooks or textual materials used.**

10211	TTh	10:30am - 1:20pm	McFaul, J	26D-3280
		and arrange 6.25 hours	McFaul, J	ONLINE

**NOTE: CRN 10211 is a Hybrid Class** taught partially online with Scheduled Meetings on Campus.

**How to Begin Course:** Log into Canvas through the e-Learning Tools tab in the Mt.SAC portal at [inside.mtsac.edu](http://inside.mtsac.edu). Then click on the Canvas link and then click on the CRN to log into your DL course. **NOTE:** Some courses may not be activated until the start of the term. If you cannot locate your DL course in Canvas when the term starts, contact the professor. **On the first day of classes, log into your DL course to show your "attendance" because not doing so could result in your being dropped from the class for non-attendance.**

**Professor contact info:** Email Professor McFaul at either: JDMcFaul@mtsac.edu, through Student Detail Schedule or Canvas at MyMtSAC Portal.

**Students must use their Mt.SAC e-mail account and be aware of course commitment and student expectations described at <http://www.mtsac.edu/distancelearning/>**

**To prepare for a successful online learning experience, see helpful short videos at <http://www.mtsac.edu/distancelearning/quiz/>**

## ENGLISH COURSE SEQUENCE: IF ENGLISH IS NOT YOUR PRIMARY LANGUAGE

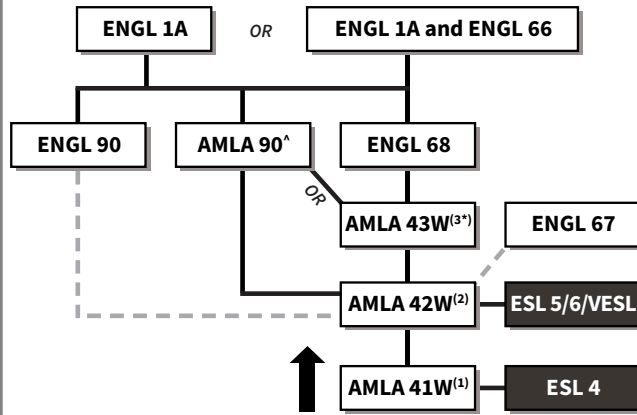

**COURSE NOTES:**

- \* Meets graduation requirement for AA/AS degree/graduation competency
- Suggested for students who no longer need second language support and who have high confidence in listening, speaking, reading, and grammar.
- ^ Suggested for students who need second language support. Appropriate for students who have confidence in speaking and listening and intermediate-advanced reading skills.
- 1 Corresponding Reading Course Advisory: AMLA 31R
- 2 Corresponding Reading Course Advisory: AMLA 32R
- 3 Corresponding Reading Course Advisory: AMLA 33R

**Where a student begins the sequence is determined by placement results, the writing placement test, or successful completion of non-credit ESL.**

10225 TTh 1:30pm - 4:20pm Arterburn, P 26D-3481  
and arrange 6.25 hours Arterburn, P ONLINE

**NOTE: CRN 10225 is a Hybrid Class** taught partially online with Scheduled Meetings on Campus.

**How to Begin Course:** Log into Canvas through the e-Learning Tools tab in the Mt.SAC portal at [inside.mtsac.edu](http://inside.mtsac.edu). Then click on the Canvas link and then click on the CRN to log into your DL course. **NOTE:** Some courses may not be activated until the start of the term. If you cannot locate your DL course in Canvas when the term starts, contact the professor. **On the first day of classes, log into your DL course to show your "attendance" because not doing so could result in your being dropped from the class for non-attendance.**

**Professor contact info:** Email Professor Arterburn at either: PArterburn@mtsac.edu, through Student Detail Schedule or Canvas at MyMt-SAC Portal.

**Students must use their Mt.SAC e-mail account and be aware of course commitment and student expectations described at <http://www.mtsac.edu/distancelearning/>**

**To prepare for a successful online learning experience, see helpful short videos at <http://www.mtsac.edu/distancelearning/quiz/>**

10242	MTWTh	4:30pm - 7:20pm	Johnson, S	26D-2210
10623	MTWTh	4:30pm - 7:20pm	Myers, R	26A-1871
10196	MTWTh	7:30pm - 10:20pm	Myers, R	26A-1871
10197	MTWTh	7:30pm - 10:20pm	Mullane, D	26A-3881

■ **ENGL 1AH — Freshman Composition - Honors** 4.0 Units  
(C-ID ENGL 100) Degree Applicable, CSU, UC

*Prerequisite: Acceptance into the Honors Program*

Honors course providing an enriched experience. May not receive credit for both ENGL 1A and ENGL 1AH.

10148 MTWTh 7:30am - 10:20am Hernandez, L 26A-3690

■ **ENGL 1B — English - Introduction to Literary Types** 3.0 Units  
(C-ID ENGL 120) Degree Applicable, CSU, UC

*Prerequisite: ENGL 1A or ENGL 1AH*

Critical, oral, and written evaluation, analysis, and interpretation of short and long fiction, poetry, and drama.

10189 MTWTh 10:15am - 12:20pm Greenberg, H 21G-2

■ **ENGL 1C — Critical Thinking and Writing** 4.0 Units  
(C-ID ENGL 105) Degree Applicable, CSU, UC

*Prerequisite: ENGL 1A or ENGL 1AH*

Develops critical thinking, reading, and writing skills. Focuses on logical analysis and argumentative writing.

10088	MTWTh	7:30am - 10:20am	Pappas, G	26A-3610
10090	MTWTh	7:30am - 10:20am	Alton, S	26A-3821
10177	MTWTh	7:30am - 10:20am	Vargas, A	26A-2841
10216	MW	7:30am - 10:20am	O'Brien, P	26D-3280
		and arrange 6.25 hours	O'Brien, P	ONLINE

**NOTE: CRN 10216 is a Hybrid Class** taught partially online with Scheduled Meetings on Campus.

**How to Begin Course:** Log into Canvas through the e-Learning Tools tab in the Mt.SAC portal at [inside.mtsac.edu](http://inside.mtsac.edu). Then click on the Canvas link and then click on the CRN to log into your DL course. **NOTE:** Some courses may not be activated until the start of the term. If you cannot locate your DL course in Canvas when the term starts, contact the professor. **On the first day of classes, log into your DL course to show your "attendance" because not doing so could result in your being dropped from the class for non-attendance.**

**Professor contact info:** Email Professor O'Brien at either: PO'Brien@mtsac.edu, through Student Detail Schedule or Canvas at MyMtSAC Portal.

**Students must use their Mt.SAC e-mail account and be aware of course commitment and student expectations described at <http://www.mtsac.edu/distancelearning/>**

**To prepare for a successful online learning experience, see helpful short videos at <http://www.mtsac.edu/distancelearning/quiz/>**

10091	MTWTh	10:30am - 1:20pm	Hernandez, J	26A-2841
10272	MTWTh	10:30am - 1:20pm	Holland, D	26A-3891
10176	MW	10:30am - 1:20pm	O'Brien, P	26D-3280
		and arrange 6.25 hours	O'Brien, P	ONLINE

**NOTE: CRN 10176 is a Hybrid Class** taught partially online with Scheduled Meetings on Campus.

**How to Begin Course:** Log into Canvas through the e-Learning Tools tab in the Mt.SAC portal at [inside.mtsac.edu](http://inside.mtsac.edu). Then click on the Canvas link and then click on the CRN to log into your DL course. **NOTE:** Some courses may not be activated until the start of the term. If you cannot locate your DL course in Canvas when the term starts, contact the professor. **On the first day of classes, log into your DL course to show your "attendance" because not doing so could result in your being dropped from the class for non-attendance.**

**Professor contact info:** Email Professor O'Brien at either: PO'Brien@mtsac.edu, through Student Detail Schedule or Canvas at MyMtSAC Portal.

**Students must use their Mt.SAC e-mail account and be aware of course commitment and student expectations described at <http://www.mtsac.edu/distancelearning/>**

**To prepare for a successful online learning experience, see helpful short videos at <http://www.mtsac.edu/distancelearning/quiz/>**

10089	MTWTh	1:30pm - 4:20pm	Cushing, W	26A-3821
10178	MTWTh	1:30pm - 4:20pm	Mushik, M	26A-3811
10179	MTWTh	4:30pm - 7:20pm	Mc Kennon, A	26A-3811
10180	MTWTh	4:30pm - 7:20pm	Mattoon, M	26A-2841
10274	MTWTh	7:30pm - 10:20pm	Francev, P	26A-3821

■ **ENGL 1CH — Critical Thinking and Writing - Honors** 4.0 Units  
(C-ID ENGL 105) Degree Applicable, CSU, UC

*Prerequisite: ENGL 1A or ENGL 1AH and acceptance into the Honors Program*

An honors course designed to provide an enriched experience. May not receive credit for both ENGL 1C and ENGL 1CH.

10144 MTWTh 10:30am - 1:20pm Ceniceraz, J 26A-3821

■ **ENGL 66 — Paragraph Writing** 1.0 Unit  
Not Degree Applicable

(May be taken for option of Letter grade or Pass/No Pass)

Analysis and writing of paragraphs. Through the process of writing, the Student learns to state and support a topic idea.

11141 MTh 1:30pm - 2:20pm Gomez, F 26A-3670

**NOTE: CRN 11141 above is designed for students in the Summer Bridge Program. Special approval is needed to enroll in this learning community. For more information, please contact (909)274-5392.**

**ENGL 67 — Writing Fundamentals** **4.0 Units**

Not Degree Applicable

(May be taken for option of Letter grade or Pass/NoPass)

*Prerequisite:* Satisfactory score on the English Placement Test or completion of AMLA 42W or completion of LERN 81

Emphasizes sentence, outlining, summary, paragraph and essay skills, and critical thinking through combining reading and writing.

10118 MTWTh 7:30am - 10:20am Matthews, A 26D-3290

**NOTE: No cost digital textbooks or textual materials used.**

10120 MTWTh 7:30am - 10:20am Key Ketter, L 26D-G471

10122 MTWTh 10:30am - 1:20pm Danson, E 26A-3610

**NOTE:** CRN 10122 above is designed for students in the Summer Bridge Program. Special approval is needed to enroll in this learning community. For more information, please contact (909)274-5392.

10146 MTWTh 10:30am - 1:20pm Wong, A 21F-2

10195 MTWTh 4:30pm - 7:20pm Lam, W 26A-3881

10205 MTWTh 7:30pm - 10:20pm Hancock, J 26D-3481

**ENGL 68 — Preparation for College Writing** **4.0 Units**

Not Degree Applicable

(May be taken for option of Letter grade or Pass/NoPass)

*Prerequisite:* ENGL 67 or AMLA 43W or satisfactory score on the English Placement Test

Development of the academic essay based on critical reading of texts.

10103 MTWTh 7:30am - 10:20am Hight, L 26A-3831

10108 MTWTh 7:30am - 10:20am Kordich, J 26A-3680

10113 MTWTh 7:30am - 10:20am Hallsted, C 26A-3841

10115 MTWTh 7:30am - 10:20am Piluso, R 26A-3811

**NOTE:** ENGL 68 (CRN 10115) is a part of the Pathways Program. Your success in this summer program will guarantee your spot in ENGL 1A and ENGL 1C in Fall 2018. This class is a part of English Cohort #1. If you have any questions please email pathways@mtsac.edu or call (909) 274-5703.

10116 MTWTh 10:30am - 1:20pm Hight, L 26A-3831

**NOTE:** CRN 10116 above is designed for students in the Summer Bridge Program. Special approval is needed to enroll in this learning community. For more information, please contact (909)274-5392.

10157 MTWTh 10:30am - 1:20pm Quintana-Mullane, K 26A-3690

10169 MTWTh 10:30am - 1:20pm STAFF 26A-2831

10170 MTWTh 10:30am - 1:20pm Hallsted, C 26A-3841

10264 MTWTh 10:30am - 1:20pm Piluso, R 26A-3811

**NOTE:** ENGL 68 (CRN 10264) is a part of the Pathways Program. Your success in this summer program will guarantee your spot in ENGL 1A and ENGL 1C in Fall 2018. This class is a part of English Cohort #2. If you have any questions please email pathways@mtsac.edu or call (909) 274-5703.

10187 MTWTh 1:30pm - 4:20pm Olds, J 26D-3280

**NOTE: No cost digital textbooks or textual materials used.**

10190 MTWTh 1:30pm - 4:20pm Quintana-Mullane, K 26A-3690

10191 TTh 1:30pm - 4:20pm Dougherty, M 26D-3290

and arrange 6.25 hours Dougherty, M ONLINE

**NOTE:** CRN 10191 is a Hybrid Class taught partially online with Scheduled Meetings on Campus.

**How to Begin Course:** Log into Canvas through the e-Learning Tools tab in the Mt.SAC portal at inside.mtsac.edu. Then click on the Canvas link and then click on the CRN to log into your DL course. **NOTE:** Some courses may not be activated until the start of the term. If you cannot locate your DL course in Canvas when the term starts, contact the professor. **On the first day of classes, log into your DL course to show your "attendance" because not doing so could result in your being dropped from the class for non-attendance.**

**Professor contact info:** Email Professor Dougherty at either: MDougherty@mtsac.edu, through Student Detail Schedule or Canvas at MyMtSAC Portal.

**Students must use their Mt.SAC e-mail account and be aware of course commitment and student expectations described at <http://www.mtsac.edu/distancelearning/>**

To prepare for a successful online learning experience, see helpful short videos at <http://www.mtsac.edu/distancelearning/quiz/>

**No cost digital textbooks or textual materials used.**

10194 MTWTh 4:30pm - 7:20pm Olds, J 26D-3280

**NOTE: No cost digital textbooks or textual materials used.**

10204 MTWTh 7:30pm - 10:20pm Erickson, E 26D-2210

**READING COURSE SEQUENCE:  
PATHWAYS TO READING COMPETENCY  
FOR AA/AS DEGREE**

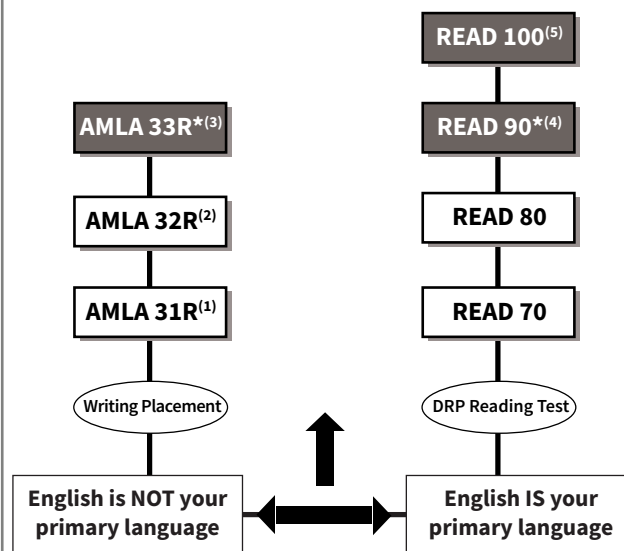

**COURSE NOTES:**

\* "C" or better meets graduation competency

- 1 - Eligibility for AMLA 41W
- 2 - Eligibility for AMLA 42W
- 3 - Eligibility for AMLA 43W
- 4 - Grade of "C" or better in READ 90 meets AA/AS degree competency
- 5 - Eligibility for READ 100 meets AA/AS degree competency and is CSU transferable

*Why take a READING CLASS early on?*

- Improves comprehension
- Supports reading across disciplines (STEM & non-STEM)
- Enhances critical thinking
- Expands vocabulary
- Promotes interaction with text

**ENGLISH: LITERATURE**

**LIT 3 — Multicultural American Literature** **3.0 Units**

Degree Applicable, CSU, UC

*Prerequisite:* Eligibility for ENGL 1A

Representative contributions of diverse groups to American literature and culture.

11123 MTWTh 10:30am - 12:35pm Kordich, J 26A-3680

**NOTE:** CRN 11123 above is designed for students in the Summer Bridge Program. Special approval is needed to enroll in this learning community. For more information, please contact (909)274-5392.

## FAMILY AND CONSUMER STUDIES

### ■ FCS 41 — Life Management 3.0 Units Degree Applicable, CSU

Life skills for effective self-management including value clarification, goal setting, time management, and money management.

10320 MW 12:20pm - 4:50pm Engstrom, R 77-2080  
10334 arrange 9 hours Fernandez, M ONLINE

**NOTE: CRN 10334 is a Distance Learning Online Class.**

**How to Begin Course:** Log into Canvas through the e-Learning Tools tab in the Mt.SAC portal at [inside.mtsac.edu](http://inside.mtsac.edu). Then click on the Canvas link and then click on the CRN to log into your DL course. **NOTE:** Some courses may not be activated until the start of the term. If you cannot locate your DL course in Canvas when the term starts, contact the professor. **On the first day of classes, log into your DL course to show your "attendance" because not doing so could result in your being dropped from the class for non-attendance.**

**Professor contact info:** Email Professor Fernandez at either: MFernandez94@mtsac.edu, through Student Detail Schedule or Canvas at MyMtSAC Portal.

**Students must use their Mt.SAC e-mail account and be aware of course commitment and student expectations described at <http://www.mtsac.edu/distancelearning/>**

**To prepare for a successful online learning experience, see helpful short videos at <http://www.mtsac.edu/distancelearning/quiz/>**

## FASHION MERCHANDISING AND DESIGN

### ■ FASH 10 — Clothing Construction I 3.0 Units Degree Applicable, CSU

Essentials of industry standard apparel construction techniques using a variety of machines and equipment.

10293 MTWTh 9:00am - 10:15am Davis, M 78-2160  
and MTWTh 10:25am - 12:30pm Davis, M 78-2160

### ■ FASH 14 — Dress, Culture, and Identity 3.0 Units Degree Applicable, CSU

The interrelatedness of socio-psychological, economic, cultural, and influences on dress, and fashion in historical perspective.

10327 TTh 12:20pm - 4:45pm Fueger, M 78-2100

### ■ FASH 23 — Patternmaking II 3.0 Units Degree Applicable

*Prerequisite: FASH 21 and FASH 25*

Intermediate pattern drafting and flat patternmaking, with an introduction to the grading of patterns and technical packages.

10294 MTW 3:00pm - 4:50pm Davis, M 78-2185  
and MTW 5:00pm - 7:50pm Davis, M 78-2185

## FIRE TECHNOLOGY

### ■ FIRE 1 — Fire Protection Organization 3.0 Units Degree Applicable, CSU

Careers in fire protection, history of fire protection, public, private and fire department functions, and fire behaviors.

10815 arrange 9 hours Shull, S ONLINE

**NOTE: CRN 10815 is a Distance Learning Online Class.**

**How to Begin Course:** Log into Canvas through the e-Learning Tools tab in the Mt.SAC portal at [inside.mtsac.edu](http://inside.mtsac.edu). Then click on the Canvas link and then click on the CRN to log into your DL course. **NOTE:** Some courses may not be activated until the start of the term. If you cannot locate your DL course in Canvas when the term starts, contact the professor. **On the first day of classes, log into your DL course to show your "attendance" because not doing so could result in your being dropped from the class for non-attendance.**

**Professor contact info:** Email Chief Shull at either: sshull@mtsac.edu, through Student Detail Schedule or Canvas at MyMtSAC Portal.

**Students must use their Mt.SAC e-mail account and be aware of course commitment and student expectations described at <http://www.mtsac.edu/distancelearning/>**

**To prepare for a successful online learning experience, see helpful short videos at <http://www.mtsac.edu/distancelearning/quiz/>**

### ■ FIRE 2 — Fire Prevention Technology 3.0 Units Degree Applicable, CSU

History of fire prevention, including codes, ID and hazard correction, investigation, and public safety education.

10817 arrange 9 hours Shull, S ONLINE

**NOTE: CRN 10817 is a Distance Learning Online Class.**

**How to Begin Course:** Log into Canvas through the e-Learning Tools tab in the Mt.SAC portal at [inside.mtsac.edu](http://inside.mtsac.edu). Then click on the Canvas link and then click on the CRN to log into your DL course. **NOTE:** Some courses may not be activated until the start of the term. If you cannot locate your DL course in Canvas when the term starts, contact the professor. **On the first day of classes, log into your DL course to show your "attendance" because not doing so could result in your being dropped from the class for non-attendance.**

**Professor contact info:** Email Chief Shull at either: sshull@mtsac.edu, through Student Detail Schedule or Canvas at MyMtSAC Portal.

**Students must use their Mt.SAC e-mail account and be aware of course commitment and student expectations described at <http://www.mtsac.edu/distancelearning/>**

**To prepare for a successful online learning experience, see helpful short videos at <http://www.mtsac.edu/distancelearning/quiz/>**

### ■ FIRE 3 — Fire Protection Equipment and Systems 3.0 Units Degree Applicable, CSU

*Advisory: FIRE 1*

Portable fire extinguishing equipment, sprinklers, water supply, alarms, and detection systems.

10022 TTh 7:30am - 11:45am Bryan, P 28B-203

### ■ FIRE 4 — Building Construction for Fire Protection 3.0 Units Degree Applicable, CSU

*Advisory: FIRE 1*

Building construction and fire code safety relating to pre-planning, engineering, inspections and fire ground operations.

10037 TTh 12:20pm - 4:35pm Bryan, P 28B-203

### ■ FIRE 91 — Fire Academy Ladder Orientation 1.0 Unit Not Degree Applicable

(May be taken for Pass/No Pass Only)

Intensive training in ladder manipulation to prepare students for Fire Academy and physical fitness tests given by fire departments.

10027 M 8:00am - 12:05pm Dominick, S CVIFD  
and M 1:00pm - 5:05pm Dominick, S CVIFD

and arrange 32 hours Dominick, S CVIFD

**1 Weeks, Week beginning 08/20/2018 ending 08/26/2018**

10028 M 8:00am - 12:05pm Dominick, S CVIFD  
and M 1:00pm - 5:05pm Dominick, S CVIFD

and arrange 32 hours Mayfield, R CVIFD

**1 Weeks, Week beginning 08/20/2018 ending 08/26/2018**

10029 M 8:00am - 12:05pm Dominick, S CVIFD  
and M 1:00pm - 5:05pm Dominick, S CVIFD

and arrange 32 hours Ramirez, B CVIFD

**1 Weeks, Week beginning 08/20/2018 ending 08/26/2018**

10030 M 8:00am - 12:05pm Dominick, S CVIFD  
and M 1:00pm - 5:05pm Dominick, S CVIFD

and arrange 32 hours Pollock, L CVIFD

**1 Weeks, Week beginning 08/20/2018 ending 08/26/2018**

## FRENCH

### ■ FRCH 1 — Elementary French 4.0 Units Degree Applicable, CSU, UC

Beginning course for students without prior exposure to French.

10232 MTWTh 10:30am - 1:20pm Erturk, F 77-1040

## GEOGRAPHY

### ■ GEOG 1 — Physical Geography 3.0 Units (C-ID GEOG 110) Degree Applicable, CSU, UC

*Prerequisite: Eligibility for ENGL 1A*

Study of the natural processes creating the Earth's physical environments: weather, climate, landforms, soils, and ecosystems.

10184 TWTh 10:30am - 1:20pm Gorcik, R 26D-3270

**NOTE:** CRN 10184 above is designed for students in the Summer Science Transfer Bridge experience. Special approval is needed to enroll in this section due to a one week stay at a 4-year university during the final week of the summer session. For further information, please call (909)274-4411 or visit Bldg. 9E, 3rd floor, ACES Program.

10185 TWTh 4:30pm - 7:20pm Bayle, M 26D-3270  
10124 arrange 9 hours Golden, D ONLINE

**NOTE:** CRN 10124 is a **Distance Learning Online Class**.

**How to Begin Course:** Log into Canvas through the e-Learning Tools tab in the Mt.SAC portal at [inside.mtsac.edu](http://inside.mtsac.edu). Then click on the Canvas link and then click on the CRN to log into your DL course. **NOTE:** Some courses may not be activated until the start of the term. If you cannot locate your DL course in Canvas when the term starts, contact the professor. **On the first day of classes, log into your DL course to show your "attendance" because not doing so could result in your being dropped from the class for non-attendance.**

**Professor contact info:** Email Professor Golden at either: DGolden@mtsac.edu, through Student Detail Schedule or Canvas at MyMtSAC Portal.

**Students must use their Mt.SAC e-mail account and be aware of course commitment and student expectations described at <http://www.mtsac.edu/distancelearning/>**

**To prepare for a successful online learning experience, see helpful short videos at <http://www.mtsac.edu/distancelearning/quiz/>**

10220 arrange 9 hours Golden, D ONLINE

**NOTE:** CRN 10220 is a **Distance Learning Online Class**.

**How to Begin Course:** Log into Canvas through the e-Learning Tools tab in the Mt.SAC portal at [inside.mtsac.edu](http://inside.mtsac.edu). Then click on the Canvas link and then click on the CRN to log into your DL course. **NOTE:** Some courses may not be activated until the start of the term. If you cannot locate your DL course in Canvas when the term starts, contact the professor. **On the first day of classes, log into your DL course to show your "attendance" because not doing so could result in your being dropped from the class for non-attendance.**

**Professor contact info:** Email Professor Golden at either: DGolden@mtsac.edu, through Student Detail Schedule or Canvas at MyMtSAC Portal.

**Students must use their Mt.SAC e-mail account and be aware of course commitment and student expectations described at <http://www.mtsac.edu/distancelearning/>**

**To prepare for a successful online learning experience, see helpful short videos at <http://www.mtsac.edu/distancelearning/quiz/>**

10221 arrange 9 hours Golden, D ONLINE

**NOTE:** CRN 10221 is a **Distance Learning Online Class**.

**How to Begin Course:** Log into Canvas through the e-Learning Tools tab in the Mt.SAC portal at [inside.mtsac.edu](http://inside.mtsac.edu). Then click on the Canvas link and then click on the CRN to log into your DL course. **NOTE:** Some courses may not be activated until the start of the term. If you cannot locate your DL course in Canvas when the term starts, contact the professor. **On the first day of classes, log into your DL course to show your "attendance" because not doing so could result in your being dropped from the class for non-attendance.**

**Professor contact info:** Email Professor Golden at either: DGolden@mtsac.edu, through Student Detail Schedule or Canvas at MyMtSAC Portal.

**Students must use their Mt.SAC e-mail account and be aware of course commitment and student expectations described at <http://www.mtsac.edu/distancelearning/>**

**To prepare for a successful online learning experience, see helpful short videos at <http://www.mtsac.edu/distancelearning/quiz/>**

### ■ GEOG 1L — Physical Geography Laboratory 1.0 Unit (C-ID GEOG 111) Degree Applicable, CSU, UC

*Corequisite: GEOG 1 or GEOG 1H (May have been taken previously)*

*Advisory: MATH 50*

Geographical observations, experiments and demonstrations in a lab setting to explore natural earth processes and systems.

10186 TWTh 1:30pm - 4:20pm Gorcik, R 26D-3270

**NOTE:** CRN 10186 above is designed for students in the Summer Science Transfer Bridge experience. Special approval is needed to enroll in this section due to a one week stay at a 4-year university during the final week of the summer session. For further information, please call (909)274-4411 or visit Bldg. 9E, 3rd floor, ACES Program.

### ■ GEOG 2 — Human Geography 3.0 Units (C-ID GEOG 120) Degree Applicable, CSU, UC

*Prerequisite: Eligibility for ENGL 1A*

Human geography with emphasis on critical areas of inquiry, research, and the interconnections of place and process.

10072 TWTh 7:30am - 10:20am STAFF 26D-3270

10125 arrange 9 hours Lobb, E ONLINE

**NOTE:** CRN 10125 is a **Distance Learning Online Class**.

**How to Begin Course:** Log into Canvas through the e-Learning Tools tab in the Mt.SAC portal at [inside.mtsac.edu](http://inside.mtsac.edu). Then click on the Canvas link and then click on the CRN to log into your DL course. **NOTE:** Some courses may not be activated until the start of the term. If you cannot locate your DL course in Canvas when the term starts, contact the professor. **On the first day of classes, log into your DL course to show your "attendance" because not doing so could result in your being dropped from the class for non-attendance.**

**Professor contact info:** Email Professor Lobb at either: ELobb@mtsac.edu, through Student Detail Schedule or Canvas at MyMtSAC Portal.

**Students must use their Mt.SAC e-mail account and be aware of course commitment and student expectations described at <http://www.mtsac.edu/distancelearning/>**

**To prepare for a successful online learning experience, see helpful short videos at <http://www.mtsac.edu/distancelearning/quiz/>**

10126 arrange 9 hours Lobb, E ONLINE

**NOTE:** CRN 10126 is a **Distance Learning Online Class**.

**How to Begin Course:** Log into Canvas through the e-Learning Tools tab in the Mt.SAC portal at [inside.mtsac.edu](http://inside.mtsac.edu). Then click on the Canvas link and then click on the CRN to log into your DL course. **NOTE:** Some courses may not be activated until the start of the term. If you cannot locate your DL course in Canvas when the term starts, contact the professor. **On the first day of classes, log into your DL course to show your "attendance" because not doing so could result in your being dropped from the class for non-attendance.**

**Professor contact info:** Email Professor Lobb at either: ELobb@mtsac.edu, through Student Detail Schedule or Canvas at MyMtSAC Portal.

**Students must use their Mt.SAC e-mail account and be aware of course commitment and student expectations described at <http://www.mtsac.edu/distancelearning/>**

**To prepare for a successful online learning experience, see helpful short videos at <http://www.mtsac.edu/distancelearning/quiz/>**

## GEOLOGY

### ■ GEOL 8 — Earth Science 3.0 Units Degree Applicable, CSU, UC

Fundamentals of geology, oceanography, meteorology, and astronomy.

Field trips required. Take with GEOL 8L for lecture/lab credit.

10453 TWTh 10:30am - 1:20pm Kingsbury, S 11-2324

10454 TWTh 1:30pm - 4:20pm Fair, C 11-2324

10642 TWTh 7:00pm - 9:50pm Ohare, D 11-2324

### ■ GEOL 8L — Earth Science Laboratory 1.0 Unit Degree Applicable, CSU, UC

*Corequisite: GEOL 8 or GEOL 8H (May have been taken previously)*

Laboratory applications and problem-solving in geology, oceanography, meteorology, and astronomy.

10455 TWTh 1:30pm - 4:20pm Kingsbury, S 60-1515

■ **GEOL 9 — Environmental Geology** **3.0 Units**  
Degree Applicable, CSU, UC

*Advisory: ENGL 1A*

Human interactions with the geological environment for non-science majors. Field trips required.

10476 TWTh 10:30am - 1:20pm STAFF 60-1512

■ **GEOL 10 — Natural Disasters** **3.0 Units**  
Degree Applicable, CSU, UC

A survey of the hazards faced by humans from the natural environment. Field trips required.

10477 TWTh 1:30pm - 4:20pm STAFF 60-1512

## GERMAN

■ **GERM 1 — Elementary German** **4.0 Units**  
Degree Applicable, CSU, UC

For students new to German, develops the ability to converse, read, and write in German. Includes cultural component.

10233 MTWTh 7:30pm - 10:20pm Tsai, J 66-248

## HISTORY

■ **HIST 1 — History of the United States** **3.0 Units**  
Degree Applicable, CSU, UC

*Prerequisite: Eligibility for ENGL 68*

History of the United States from Native American and colonial times to present. History majors should take History 7 and 8.

10565 TWTh 7:30am - 10:20am Carlson, F 40-131

10566 TWTh 7:30am - 10:20am Chavez, R 26A-1811

10572 TWTh 7:30am - 10:20am Tellez, A 26A-1831

10573 TWTh 10:30am - 1:20pm Browne, E 26A-1821

10574 TWTh 10:30am - 1:20pm Hajialiakbar, L 26D-G290

10575 TWTh 10:30am - 1:20pm Hunt, R 26D-G431

10576 TWTh 10:30am - 1:20pm Okonyan, D 26D-2421

10577 TWTh 1:30pm - 4:20pm Browne, E 26A-1821

10578 TWTh 1:30pm - 4:20pm Meza, J 26A-1831

10579 TWTh 4:30pm - 7:20pm Meza, J 26A-1831

10587 arrange 9 hours Haines, A ONLINE

**NOTE: CRN 10587 is a Distance Learning Online Class.**

**How to Begin Course:** Log into Canvas through the e-Learning Tools tab in the Mt.SAC portal at [inside.mtsac.edu](http://inside.mtsac.edu). Then click on the Canvas link and then click on the CRN to log into your DL course. **NOTE:** Some courses may not be activated until the start of the term. If you cannot locate your DL course in Canvas when the term starts, contact the professor. **On the first day of classes, log into your DL course to show your "attendance" because not doing so could result in your being dropped from the class for non-attendance.**

**Professor contact info:** Email Professor Haines at either: AHaines@mtsac.edu, through Student Detail Schedule or Canvas at MyMtSAC Portal.

**Students must use their Mt.SAC e-mail account and be aware of course commitment and student expectations described at <http://www.mtsac.edu/distancelearning/>**

**To prepare for a successful online learning experience, see helpful short videos at <http://www.mtsac.edu/distancelearning/quiz/>**

10588 arrange 9 hours Melo, F ONLINE

**NOTE: CRN 10588 is a Distance Learning Online Class.**

**How to Begin Course:** Log into Canvas through the e-Learning Tools tab in the Mt.SAC portal at [inside.mtsac.edu](http://inside.mtsac.edu). Then click on the Canvas link and then click on the CRN to log into your DL course. **NOTE:** Some courses may not be activated until the start of the term. If you cannot locate your DL course in Canvas when the term starts, contact the professor. **On the first day of classes, log into your DL course to show your "attendance" because not doing so could result in your being dropped from the class for non-attendance.**

**Professor contact info:** Email Professor Melo at either: FMelo@mtsac.edu, through Student Detail Schedule or Canvas at MyMtSAC Portal.

**Students must use their Mt.SAC e-mail account and be aware of course commitment and student expectations described at <http://www.mtsac.edu/distancelearning/>**

**To prepare for a successful online learning experience, see helpful short videos at <http://www.mtsac.edu/distancelearning/quiz/>**

11124 arrange 9 hours Menzing, T ONLINE  
**NOTE: CRN 11124 is a Distance Learning Online Class.**

**How to Begin Course:** Log into Canvas through the e-Learning Tools tab in the Mt.SAC portal at [inside.mtsac.edu](http://inside.mtsac.edu). Then click on the Canvas link and then click on the CRN to log into your DL course. **NOTE:** Some courses may not be activated until the start of the term. If you cannot locate your DL course in Canvas when the term starts, contact the professor. **On the first day of classes, log into your DL course to show your "attendance" because not doing so could result in your being dropped from the class for non-attendance.**

**Professor contact info:** Email Professor Menzing at either: TMenzing@mtsac.edu, through Student Detail Schedule or Canvas at MyMtSAC Portal.

**Students must use their Mt.SAC e-mail account and be aware of course commitment and student expectations described at <http://www.mtsac.edu/distancelearning/>**

**To prepare for a successful online learning experience, see helpful short videos at <http://www.mtsac.edu/distancelearning/quiz/>**

**No cost digital textbooks or textual materials used.**

■ **HIST 3 — World History: Prehistoric to Early Modern** **3.0 Units**  
Degree Applicable, CSU, UC

*Prerequisite: Eligibility for ENGL 1A*

Human societies from their origins to the Early Modern period from a global and comparative perspective.

10580 TWTh 10:30am - 1:20pm Carlson, F 40-131

■ **HIST 4 — World History: Early Modern to the Present** **3.0 Units**  
(C-ID HIST 160) Degree Applicable, CSU, UC

*Prerequisite: Eligibility for ENGL 1A*

Social, political, economic, and cultural changes during the modern period from a global and comparative perspective.

10581 TWTh 7:30am - 10:20am Okonyan, D 26D-2421

■ **HIST 7 — History of the United States to 1877** **3.0 Units**  
Degree Applicable, CSU, UC

*Prerequisite: Eligibility for ENGL 1A*

U.S. History to 1877. Examines social, economic, political, intellectual, military themes and patterns of U.S. development.

10582 TWTh 7:30am - 10:20am Hunt, R 26D-G431

■ **HIST 8 — History of the United States from 1865** **3.0 Units**  
Degree Applicable, CSU, UC

*Prerequisite: Eligibility for ENGL 1A*

U.S. history from 1865. Examines social, economic, political, intellectual, and military themes and patterns of U.S. development.

10583 TWTh 10:30am - 1:20pm Tellez, A 26A-1831

■ **HIST 36 — Women in American History** **3.0 Units**  
Degree Applicable, CSU, UC

*Prerequisite: Eligibility for ENGL 1A*

Women's experience within the context of major themes of United States history from Colonial times to the present.

10584 TWTh 7:30am - 10:20am Matthews, L 26D-G411

10585 arrange 9 hours Haines, A ONLINE

**NOTE: CRN 10585 is a Distance Learning Online Class.**

**How to Begin Course:** Log into Canvas through the e-Learning Tools tab in the Mt.SAC portal at [inside.mtsac.edu](http://inside.mtsac.edu). Then click on the Canvas link and then click on the CRN to log into your DL course. **NOTE:** Some courses may not be activated until the start of the term. If you cannot locate your DL course in Canvas when the term starts, contact the professor. **On the first day of classes, log into your DL course to show your "attendance" because not doing so could result in your being dropped from the class for non-attendance.**

**Professor contact info:** Email Professor Haines at either: AHaines@mtsac.edu, through Student Detail Schedule or Canvas at MyMtSAC Portal.

**Students must use their Mt.SAC e-mail account and be aware of course commitment and student expectations described at <http://www.mtsac.edu/distancelearning/>**

**To prepare for a successful online learning experience, see helpful short videos at <http://www.mtsac.edu/distancelearning/quiz/>**

**No cost digital textbooks or textual materials used.**

# MT. SAN ANTONIO COLLEGE HONORS PROGRAM APPLICATION

PLEASE FILL IN THE INFORMATION BELOW.

FIRST NAME \_\_\_\_\_ MIDDLE NAME \_\_\_\_\_ LAST NAME \_\_\_\_\_

MT. SAC STUDENT IDENTIFICATION NUMBER \_\_\_\_\_ PHONE NUMBER \_\_\_\_\_

MT. SAC E-MAIL ADDRESS (@student.mtsac.edu) \_\_\_\_\_ ADDITIONAL E-MAIL ADDRESS \_\_\_\_\_

ADDRESS \_\_\_\_\_

CITY \_\_\_\_\_ STATE \_\_\_\_\_ ZIP CODE \_\_\_\_\_

**ATTACH DOCUMENTS SHOWING THAT YOU HAVE MET THE FOLLOWING REQUIREMENTS  
(INCOMPLETE APPLICATIONS WILL NOT BE PROCESSED):**

- A) Required for HIGH SCHOOL applicants:**
- **MAXIMUM 350 WORD ESSAY (SEE BELOW FOR ESSAY PROMPTS)**
  - **MINIMUM 3.2 UNWEIGHTED GPA**
  - **LETTER OF RECOMMENDATION**
  - **HIGH SCHOOL TRANSCRIPTS (UNOFFICIAL TRANSCRIPTS MUST BE ATTACHED TO APPLICATION)**
  - **MUST BE ENGLISH 1A ELIGIBLE**
  - **IF APPLICABLE, AP/IB SCORES AND/OR OTHER COLLEGE TRANSCRIPTS**
- B) Required for COLLEGE applicants:**
- **MAXIMUM 350 WORD ESSAY (SEE BELOW FOR ESSAY PROMPTS)**
  - **MINIMUM 3.2 TRANSFERABLE GPA**
  - **MUST BE ENGLISH 1A ELIGIBLE**
  - **COMPLETED 9 TRANSFERABLE UNITS**
  - **LETTER OF RECOMMENDATION (WAIVED IF CUMULATIVE GPA IS 3.5 OR BETTER)**
  - **IF APPLICABLE, AP/IB SCORES AND/OR OTHER COLLEGE TRANSCRIPTS**

**ESSAY PROMPTS: CHOOSE ONE PROMPT FROM THE OPTIONS BELOW. ATTACH YOUR ESSAY TO THIS APPLICATIONS.  
DO NOT EXCEED 350 WORDS.**

- OPTION #1)** Describe an example of your leadership experience in which you have positively influenced others, helped resolve disputes or contributed to group efforts over time.
- OPTION #2)** Every person has a creative side and it can be expressed in many ways: problem solving, original and innovative thinking, and artistically, to name a few. Describe how you express your creative side.
- OPTION #3)** What would you say is your greatest talent or skill? How have you developed and demonstrated that talent over time?
- OPTION #4)** Describe how you have taken advantage of a significant educational opportunity?
- OPTION #5)** Describe how you have worked to overcome an educational barrier you have faced?
- OPTION #6)** Describe the most significant challenge you have faced and the steps you have taken to overcome this challenge. How has this challenge affected your academic achievement?
- OPTION #7)** What have you done to make your school or your community a better place?

**ALL REQUIRED DOCUMENTS MUST BE ATTACHED  
APPLICATIONS MAY BE EMAILED TO HONORS@MTSAC.EDU, DELIVERED OR MAILED TO:  
MT. SAN ANTONIO COLLEGE HONORS PROGRAM  
1100 N. GRAND AVE. BUILDING 26A, ROOM 1680  
WALNUT, CA 91789 | (909) 274-4665  
EMAIL: HONORS@MTSAC.EDU | WEBSITE: HTTP://HONORS.MTSAC.EDU**

OFFICE USE ONLY     APPROVED     PROVISIONAL ACCEPTANCE     DENIED

ADDED HONR CODE: DATE \_\_\_\_\_ EMAILED ACCEPTANCE/DENIAL: DATE \_\_\_\_\_

COMMENTS:

■ **HIST 40 — History of the Mexican American** **3.0 Units**  
Degree Applicable, CSU, UC

*Prerequisite: Eligibility for ENGL 68*  
U.S. History with a special emphasis on the role of Mexican Americans in the development of the nation.  
10586 TWTh 10:30am - 1:20pm Chavez, R 26A-1811

**HISTOTECHNOLOGY**

■ **HT 17 — Work Experience in Histotechnology** **1.0 Unit**  
Degree Applicable

(May be taken for Pass/No Pass Only)  
*Prerequisite: HT 12 and compliance with Work Experience regulations as designated in the College Catalog*  
On-the-job experience in histotechnology at an approved work site. Placement by Program Director.  
10521 12.5 hours Mac Donald, J

■ **HT 17 — Work Experience in Histotechnology** **2.0 Units**  
Degree Applicable

(May be taken for Pass/No Pass Only)  
*Prerequisite: HT 12 and compliance with Work Experience regulations as designated in the College Catalog*  
On-the-job experience in histotechnology at an approved work site. Placement by Program Director.  
10522 25 hours Mac Donald, J

**HONORS**

The following classes are open to students in the Mt. SAC Honors Program only. Information on eligibility, admissions and benefits can be found at <http://honors.mtsac.edu>. The basic admission requirements for the Honors Program are:

- For all first-time college students:**
1. Eligibility for English 1A
  2. 3.2 cumulative GPA (unweighted)

- For students who have already completed college courses:**
1. Eligibility for English 1A
  2. 3.2 transferable GPA
  3. Completion of 9 transferable units

To apply, go to <http://honors.mtsac.edu> and complete the downloadable application and submit with the required documents. For more information, contact the Honors Program at (909)274-4665, [honors@mtsac.edu](mailto:honors@mtsac.edu), or visit us in Building 26A, Room 1680.

**Honors Courses Available**

■ <b>BIOL 15H — Human Sexuality - Honors</b>	<b>3.0 Units</b>
10524 arrange 9 hours Hoggan, L	ONLINE
■ <b>ENGL 1AH — Freshman Composition - Honors</b>	<b>4.0 Units</b>
10148 MTWTh 7:30am - 10:20am Hernandez, L	26A-3690
■ <b>ENGL 1CH — Critical Thinking and Writing - Honors</b>	<b>4.0 Units</b>
10144 MTWTh 10:30am - 1:20pm Ceniceroy, J	26A-3821
■ <b>PHIL 12H — Introduction to Ethics - Honors</b>	<b>3.0 Units</b>
10770 TWTh 1:30pm - 4:20pm Ramal, R	26D-2240
■ <b>PSYC 1AH — Introduction to Psychology - Honors</b>	<b>3.0 Units</b>
10229 MTW 7:30am - 10:20am Powell, C	26A-2831
■ <b>SOC 5H — Introduction to Criminology - Honors</b>	<b>3.0 Units</b>
11055 TWTh 10:30am - 1:20pm Gatillon, J	21H-1
■ <b>SPCH 1AH — Public Speaking - Honors</b>	<b>4.0 Units</b>
10150 MTWTh 10:30am - 1:20pm Laverty, J	26D-1411

**HOSPITALITY AND RESTAURANT MANAGEMENT**

■ **HRM 51 — Introduction to Hospitality** **3.0 Units**  
Degree Applicable, CSU

*Prerequisite: Eligibility for ENGL 68*  
Overview of structure and financial performance of hospitality industry, including food, lodging, resorts, and related operations.  
10561 arrange 9 hours Doonan, S ONLINE  
**NOTE: CRN 10561 is a Distance Learning Online Class.**

**How to Begin Course:** Log into Canvas through the e-Learning Tools tab in the Mt.SAC portal at [inside.mtsac.edu](http://inside.mtsac.edu). Then click on the Canvas link and then click on the CRN to log into your DL course. **NOTE:** Some courses may not be activated until the start of the term. If you cannot locate your DL course in Canvas when the term starts, contact the professor. **On the first day of classes, log into your DL course to show your "attendance" because not doing so could result in your being dropped from the class for non-attendance.**

**Professor contact info:** Email Professor Doonan at either: [SDoonan@mtsac.edu](mailto:SDoonan@mtsac.edu), through Student Detail Schedule or Canvas at MyMtSAC Portal.

**Students must use their Mt.SAC e-mail account and be aware of course commitment and student expectations described at <http://www.mtsac.edu/distancelearning/>**

**To prepare for a successful online learning experience, see helpful short videos at <http://www.mtsac.edu/distancelearning/quiz/>**

■ **HRM 52 — Food Safety and Sanitation** **2.0 Units**  
Degree Applicable, CSU

*Prerequisite: Eligibility for ENGL 68*  
Sanitation practices affecting individual and commercial food service operations. Food Safety Manager Certification exam.  
10298 M 8:00am - 9:25am Shum, M 78-1100  
and arrange 4.34 hours Shum, M ONLINE

**NOTE: CRN 10298 is a Hybrid Class taught online with scheduled meetings on campus.**  
**NOTE: This course requires the passing of the Food Manager Exam to receive credit. Exam date: Monday, July 31 from 8:00 - 10:30 am in 78-2100.**

**How to Begin Course:** Log into Canvas through the eLearning Tools tab in the Mt. SAC portal at [my.mtsac.edu](http://my.mtsac.edu). Then click on the Canvas link and then click on CRN for your DL course. **NOTE:** Some courses may not be activated until the start of the term. If you cannot locate your DL course in Canvas when the term starts, contact the professor.

**Professor contact info:** Email Professor Shum at either: [MShum@mtsac.edu](mailto:MShum@mtsac.edu), through Student Detail Schedule or Canvas at MyMtSAC Portal.

**Students must use their Mt. SAC e-mail account and be aware of course commitment and student expectations described at <http://www.mtsac.edu/instruction/learning/distlearn/>**

■ **HRM 91 — Hospitality Work Experience** **1.0 Unit**  
Degree Applicable, CSU

(May be taken for Pass/No Pass Only)  
*Prerequisite: Compliance with Work Experience regulations as designated in the College Catalog*

On-the-job experience related to classroom-based learning. 75 paid or 60 non-paid hours required for each unit of credit.  
10299 arrange 12.5 hours Shum, M OCAM  
**NOTE: CRN 10299** Provides the student with on-the-job experience in an approved work site. A minimum of 75 paid hours or 60 non-paid hours per term is required for each unit of credit. Work experience placement is not guaranteed. Student must contact Career Services Specialist, Dawn Finley at [dfinley@mtsac.edu](mailto:dfinley@mtsac.edu) by Friday, May 25, 2018.



**HRM 91 — Hospitality Work Experience****2.0 Units**

Degree Applicable, CSU

(May be taken for Pass/No Pass Only)

*Prerequisite: Compliance with Work Experience regulations as designated in the College Catalog*

On-the-job experience related to classroom-based learning. 75 paid or 60 non-paid hours required for each unit of credit.

10339 arrange 25 hours Shum, M OCAM

**NOTE: CRN 10339** Provides the student with on-the-job experience in an approved work site. A minimum of 75 paid hours or 60 non-paid hours per term is required for each unit of credit. Work experience placement is not guaranteed. Student must contact Career Services Specialist, Dawn Finley at dfinley@mtsac.edu by Friday, May 25, 2018.**INTERIOR DESIGN****ID 10 — Introduction to Interior Design****2.0 Units**

Degree Applicable, CSU

Interior design that meet individual, functional and environmental needs. Field trips may be required.

10317 MTW 10:00am - 11:50am Tran, N 13-1230

**ID 23 — Computer Aided Drawing for Interior Design I****3.0 Units**

Degree Applicable, CSU

*Advisory: ID 22 or ARCH 141 or ARCH 11*

Computer Aided Drawing (CAD) as a communication element required to convey interior design ideas. Field trips may be required.

10328 MTW 12:30pm - 2:20pm Tran, N 13-1230  
and MTW 2:30pm - 5:20pm Tran, N 13-1230**ID 38 — Internship in Interior Design****2.0 Units**

Degree Applicable

(May be taken for Pass/No Pass Only)

*Prerequisite: Compliance with Work Experience/Internship regulations as designated in the College Catalog*

Designed to provide the student with actual on-the-job experience in the interior design profession.

10295 arrange 25 hours Tran, N OCAM

**NOTE: CRN 10295** requires a minimum of 75 paid hours or 60 non-paid hours is required for each unit of credit per term. Work experience placement is not guaranteed, but assistance is provided. Student must contact Career Services Specialist, Dawn Finley at dfinley@mtsac.edu by Friday, May 25, 2018.**ID 48 — Internship in Kitchen and Bath****3.0 Units**

Degree Applicable

(May be taken for Pass/No Pass Only)

*Prerequisite: Compliance with Work Experience/Internship regulations as designated in the College Catalog**Corequisite: ID 40 (May have been taken previously)*

Job experience in the interior design profession at NKBA member work site. 75 paid or 60 non-paid clock hours required.

10296 arrange 37.5 hours Tran, N OCAM

**NOTE: CRN 10296** requires a minimum of 75 paid hours or 60 non-paid hours is required for each unit of credit per term. Work experience placement is not guaranteed, but assistance is provided. Student must contact Career Services Specialist, Dawn Finley at dfinley@mtsac.edu Friday, May 25, 2018.**ITALIAN****ITAL 1 — Elementary Italian****4.0 Units**

Degree Applicable, CSU, UC

Intended for students without previous exposure to Italian.

10234 MTWTh 10:30am - 1:20pm Spanu, L 77-1070

**JAPANESE****JAPN 1 — Elementary Japanese****4.0 Units**

Degree Applicable, CSU, UC

Elementary course for students without prior exposure to Japanese including an introduction to Japanese culture.

10235 MTWTh 10:30am - 1:20pm Tsurumi, K 77-1080

**Start Here.****mtsac.edu****Go Anywhere.****Interior Design****Receive A  
Certificate  
In Just One  
Semester**

## JOURNALISM

**■ JOUR 100 — Introduction to Mass Media** **3.0 Units**  
 (C-ID JOUR 100) Degree Applicable, CSU, UC

*Prerequisite: ENGL 1A*

Mass media and interrelationships with society, including history, structure, law, ethics, and trends.

 10228 TWTh 10:30am - 1:20pm DePaola, G 26D-G471  
 10624 T 1:30pm - 4:20pm DePaola, G 26D-G471  
 and arrange 6 hours DePaola, G ONLINE

**NOTE:** CRN 10624 is a **Hybrid Class** taught partially online with Scheduled Meetings on Campus.

**How to Begin Course:** Log into Canvas through the e-Learning Tools tab in the Mt.SAC portal at inside.mtsac.edu. Then click on the Canvas link and then click on the CRN to log into your DL course. **NOTE:** Some courses may not be activated until the start of the term. If you cannot locate your DL course in Canvas when the term starts, contact the professor. **On the first day of classes, log into your DL course to show your "attendance" because not doing so could result in your being dropped from the class for non-attendance.**
**Professor contact info:** Email Professor DePaola at either: GDePaola@mtsac.edu, through Student Detail Schedule or Canvas at MyMt-SAC Portal.

**Students must use their Mt.SAC e-mail account and be aware of course commitment and student expectations described at <http://www.mtsac.edu/distancelearning/>**
**To prepare for a successful online learning experience, see helpful short videos at <http://www.mtsac.edu/distancelearning/quiz/>**

## KINESIOLOGY: AQUATICS

**■ KINA 8A — Swimming - Beginning** **.5 Unit**  
 Degree Applicable, CSU, UC

(May be taken for option of Letter grade or Pass/NoPass)

10678 MTW 8:00am - 9:50am Lepp, J POOL

**NOTE:** No-cost digital textbooks or textual materials used.

10677 TWTh 10:00am - 11:50am Ruh, L POOL

**NOTE:** No-cost digital textbooks or textual materials used.

## KINESIOLOGY: ATHLETICS

**■ KINX 9 — Conditioning for Sports** **.5 Unit**  
 Degree Applicable, CSU, UC

(May be taken four times for credit)

(May be taken for option of Letter grade or Pass/NoPass)

Conditioning for athletes to develop muscular strength and endurance, flexibility, core training skills, and cardio fitness.

 10679 TWTh 11:20am - 1:10pm Crichlow, B 3-1FL  
**6 Weeks, Week beginning 07/09/2018 ending 08/19/2018**
**NOTE:** CRN 10679: is limited to intercollegiate Women's Basketball team candidates. No-cost digital textbooks or textual materials used.

 10820 TWTh 1:20pm - 3:10pm Maloney, C 3-1FL  
**6 Weeks, Week beginning 06/26/2018 ending 08/02/2018**
**NOTE:** CRN 10820: is limited to intercollegiate Men's Basketball team candidates. Class begins T, 6/26/18 and ends Th, 8/2/18. No-cost digital textbooks or textual materials used.

 10692 TTh 4:00pm - 7:10pm Pawley, T TBA  
**6 Weeks, Week beginning 07/09/2018 ending 08/19/2018**
**NOTE:** CRN 10692: is conditioning for intercollegiate Men's and Women's Tennis Team members. First class meeting will be held at the Softball Field. All other class meetings will be held at Citrus College. No-cost digital textbooks or textual materials used.

10757 TWTh 5:30pm - 7:20pm Rojas, R 45SB

**NOTE:** CRN 10757: is limited to intercollegiate Women's Softball team members. No-cost digital textbooks or textual materials used.

**■ KINX 88 — Pre-Season Athletics** **1.5 Units**  
 Degree Applicable, CSU, UC

(May be taken four times for credit)

(May be taken for option of Letter grade or Pass/NoPass)

 10694 M 7:00am - 10:10am Roth, A POOL  
 and TWTh 7:00am - 10:10am Ruh, M POOL

**6 Weeks, Week beginning 07/09/2018 ending 08/19/2018**
**NOTE:** CRN 10694: is limited to intercollegiate Men's Water Polo candidates. No-cost digital textbooks or textual materials used.

10695 MTWTh 7:00am - 10:10am Kamaka, R 44-1900

**6 Weeks, Week beginning 07/09/2018 ending 08/19/2018**
**NOTE:** CRN 10695: is limited to intercollegiate Men's Cross Country candidates. No-cost digital textbooks or textual materials used.

10696 MTWTh 7:00am - 10:10am Lanaro, G 44-1900

**6 Weeks, Week beginning 07/09/2018 ending 08/19/2018**
**NOTE:** CRN 10696: is limited to intercollegiate Women's Cross Country candidates. No-cost digital textbooks or textual materials used.

10759 MTWTh 7:00am - 10:10am Purper, K 45S

**6 Weeks, Week beginning 07/09/2018 ending 08/19/2018**
**NOTE:** CRN 10759: is limited to intercollegiate Women's Soccer candidates. No-cost digital textbooks or textual materials used.

10760 MTWTh 7:00am - 10:10am Ignacio, R 2-T121

**6 Weeks, Week beginning 07/09/2018 ending 08/19/2018**
**NOTE:** CRN 10760: is limited to intercollegiate Pep Squad candidates. No-cost digital textbooks or textual materials used.

10698 MTWTh 8:00am - 11:10am Oliver, A 3-1FL

**6 Weeks, Week beginning 07/09/2018 ending 08/19/2018**
**NOTE:** CRN 10698: is limited to intercollegiate Women's Volleyball candidates. No-cost digital textbooks or textual materials used.

10697 MTWTh 9:00am - 12:10pm Sanchez, J 45S

**6 Weeks, Week beginning 07/09/2018 ending 08/19/2018**
**NOTE:** CRN 10697: is limited to intercollegiate Men's Soccer candidates. No-cost digital textbooks or textual materials used.

10814 MTWTh 10:25am - 1:35pm Jackson, C POOL

**NOTE:** CRN 10814: is limited to intercollegiate Women's Water Polo candidates. No-cost digital textbooks or textual materials used.

10756 MW 12:00pm - 6:10pm Osbourne, G 45G

**6 Weeks, Week beginning 07/09/2018 ending 08/19/2018**
**NOTE:** CRN 10756: is limited to intercollegiate Women's Golf candidates. No-cost digital textbooks or textual materials used.

10693 MTWTh 4:30pm - 7:20pm Jastrab, R 45S

**NOTE:** CRN 10693: is limited to intercollegiate Football candidates. No-cost digital textbooks or textual materials used.

10701 MTWTh 5:00pm - 8:10pm Rivera, D 27C-201

**6 Weeks, Week beginning 07/09/2018 ending 08/19/2018**
**NOTE:** CRN 10701: is limited to intercollegiate Wrestling candidates. No-cost digital textbooks or textual materials used.

## KINESIOLOGY: FITNESS

**■ KINF 10A — Weight Training - Beginning** **.5 Units**  
 Degree Applicable, CSU, UC

(May be taken for option of Letter grade or Pass/NoPass)

10717 MTW 8:00am - 9:50am Deen, C 44-1600

**NOTE:** No-cost digital textbooks or textual materials used.

10719 MTW 10:00am - 11:50am Johnson, L 44-1600

**NOTE:** No-cost digital textbooks or textual materials used.

**■ KINF 10B — Weight Training - Intermediate** **.5 Units**  
 Degree Applicable, CSU, UC

(May be taken for option of Letter grade or Pass/NoPass)

*Advisory: KINF 10A or weight training experience*

10718 MTW 8:00am - 9:50am Deen, C 44-1600

**NOTE:** No-cost digital textbooks or textual materials used.

10720 MTW 10:00am - 11:50am Johnson, L 44-1600

**NOTE:** No-cost digital textbooks or textual materials used.

**■ KINF 34A — Cardiorespiratory Training Beginning .5 Units**

Degree Applicable, CSU, UC

(May be taken for option of Letter grade or Pass/NoPass)

Beginning individualized cardiovascular exercise for students needing to start at a fundamental level of intensity.

10725 arrange 6 hours Lanaro, G 27A-2

**NOTE:** CRN 10725: Students must come to Building 27A-ESWC between the hours of MT 7:00 a.m.- 2:00 p.m. or MT 6:00-9:00 p.m. during the FIRST WEEK of the term to "E" (enter into class) or your space will be given to a student on the Wait List. WORKOUT HOURS must be completed between MTWTh 7:00 a.m.- 2:00 p.m. and MTWTh 6:00 p.m.- 9:00 p.m. No-cost digital textbooks or textual materials used.

**■ KINF 34A — Cardiorespiratory Training Beginning 1.0 Unit**

Degree Applicable, CSU, UC

(May be taken for option of Letter grade or Pass/NoPass)

Beginning individualized cardiovascular exercise for students needing to start at a fundamental level of intensity.

10727 arrange 9 hours Lanaro, G 27A-2

**NOTE:** CRN 10727: Students must come to Building 27A-ESWC between the hours of MT 7:00 a.m.- 2:00 p.m. or

MT 6:00-9:00 p.m. during the FIRST WEEK of the term to "E" (enter into class) or your space will be given to a student on the Wait List. WORKOUT HOURS must be completed between MTWTh 7:00 a.m.- 2:00 p.m. and MTWTh 6:00 p.m.- 9:00 p.m. No-cost digital textbooks or textual materials used.

**■ KINF 34B — Cardiorespiratory Training Intermediate .5 Units**

Degree Applicable, CSU, UC

(May be taken for option of Letter grade or Pass/NoPass)

Individualized cardiovascular exercise for students able to participate in aerobic activity at a moderate level of intensity.

10726 arrange 6 hours Lanaro, G 27A-2

**NOTE:** CRN 10726: Students must come to Building 27A-ESWC between the hours of MT 7:00 a.m.- 2:00 p.m. or MT 6:00-9:00 p.m. during the FIRST WEEK of the term to "E" (enter into class) or your space will be given to a student on the Wait List. WORKOUT HOURS must be completed between MTWTh 7:00 a.m.- 2:00 p.m. and MTWTh 6:00 p.m.- 9:00 p.m. No-cost digital textbooks or textual materials used.

**■ KINF 34B — Cardiorespiratory Training Intermediate 1.0 Unit**

Degree Applicable, CSU, UC

(May be taken for option of Letter grade or Pass/NoPass)

Individualized cardiovascular exercise for students able to participate in aerobic activity at a moderate level of intensity.

10728 arrange 9 hours STAFF 27A-2

**NOTE:** CRN 10728: Students must come to Building 27A-ESWC between the hours of MT 7:00 a.m.- 2:00 p.m. or

MT 6:00-9:00 p.m. during the FIRST WEEK of the term to "E" (enter into class) or your space will be given to a student on the Wait List. WORKOUT HOURS must be completed between MTWTh 7:00 a.m.- 2:00 p.m. and MTWTh 6:00 p.m.- 9:00 p.m. No-cost digital textbooks or textual materials used.

**■ KINF 36A — Circuit Training Beginning .5 Units**

Degree Applicable, CSU, UC

(May be taken for option of Letter grade or Pass/NoPass)

Beginning Circuit Training for individuals with little or no weight training experience.

10729 6 hours Lanaro, G

**NOTE:** CRN 10729: Students must come to Building 27A-ESWC between the hours of MT 7:00 a.m.- 2:00 p.m. or

MT 6:00-9:00 p.m. during the FIRST WEEK of the term to "E" (enter into class) or your space will be given to a student on the Wait List. WORKOUT HOURS must be completed between MTWTh 7:00 a.m.- 2:00 p.m. and MTWTh 6:00 p.m.- 9:00 p.m. No-cost digital textbooks or textual materials used.

**■ KINF 36A — Circuit Training Beginning 1.0 Unit**

Degree Applicable, CSU, UC

(May be taken for option of Letter grade or Pass/NoPass)

Beginning Circuit Training for individuals with little or no weight training experience.

10731 arrange 9 hours Lanaro, G 27A-2

**NOTE:** CRN 10731: Students must come to Building 27A-ESWC between the hours of MT 7:00 a.m.- 2:00 p.m. or

MT 6:00-9:00 p.m. during the FIRST WEEK of the term to "E" (enter into class) or your space will be given to a student on the Wait List. WORKOUT HOURS must be completed between MTWTh 7:00 a.m.- 2:00 p.m. and MTWTh 6:00 p.m.- 9:00 p.m. No-cost digital textbooks or textual materials used.

**■ KINF 36B — Circuit Training Intermediate .5 Units**

Degree Applicable, CSU, UC

(May be taken for option of Letter grade or Pass/NoPass)

Circuit training for students with previous strength training experience.

10730 arrange 6 hours Lanaro, G 27A-2

**NOTE:** CRN 10730: Students must come to Building 27A-ESWC between the hours of MT 7:00 a.m.- 2:00 p.m. or

MT 6:00-9:00 p.m. during the FIRST WEEK of the term to "E" (enter into class) or your space will be given to a student on the Wait List. WORKOUT HOURS must be completed between MTWTh 7:00 a.m.- 2:00 p.m. and MTWTh 6:00 p.m.- 9:00 p.m. No-cost digital textbooks or textual materials used.

**■ KINF 36B — Circuit Training Intermediate 1.0 Unit**

Degree Applicable, CSU, UC

(May be taken for option of Letter grade or Pass/NoPass)

Circuit training for students with previous strength training experience.

10732 arrange 9 hours Lanaro, G 27A-2

**NOTE:** CRN 10732: Students must come to Building 27A-ESWC between the hours of MT 7:00 a.m.- 2:00 p.m. or

MT 6:00-9:00 p.m. during the FIRST WEEK of the term to "E" (enter into class) or your space will be given to a student on the Wait List. WORKOUT HOURS must be completed between MTWTh 7:00 a.m.- 2:00 p.m. and MTWTh 6:00 p.m.- 9:00 p.m. No-cost digital textbooks or textual materials used.

**■ KINF 38A — Aerobics-Beginning .5 Unit**

Degree Applicable, CSU, UC

(May be taken for option of Letter grade or Pass/NoPass)

Beginning group exercise to improve cardiovascular fitness using aerobic activity.

10721 TWTh 10:00am - 11:50am Jones, L 27A-3

**NOTE:** No-cost digital textbooks or textual materials used.

10723 MTW 6:00pm - 7:50pm Hackmann, D 27A-3

**NOTE:** No-cost digital textbooks or textual materials used.

**■ KINF 38B — Aerobics .5 Unit**

Degree Applicable, CSU, UC

(May be taken for option of Letter grade or Pass/NoPass)

Group aerobic exercise for students with experience in group fitness and able to exercise at moderate levels of aerobic activity.

10722 TWTh 10:00am - 11:50am Jones, L 27A-3

**NOTE:** No-cost digital textbooks or textual materials used.

10724 MTW 6:00pm - 7:50pm Hackmann, D 27A-3

**NOTE:** No-cost digital textbooks or textual materials used.

**■ KINF 51A — Agility Test Preparation Law and Fire - Beginning 1.0 Unit**

Degree Applicable, CSU

(May be taken for option of Letter grade or Pass/NoPass)

Physical agility skills specific for law enforcement and fire technology. There may be off-campus assignments.

10733 MTWTh 7:30am - 10:20am Ward, E LOT50G

**NOTE:** No-cost digital textbooks or textual materials used.

■ **KINF 51B — Agility Test Preparation Law and Fire - Intermediate** **1.0 Unit**

Degree Applicable, CSU

(May be taken for option of Letter grade or Pass/NoPass)

*Advisories: KINF 51A*

Designed to enhance competence in physical agility testing for individuals who have had instruction in primary agility training.

10734 MTWTh 7:30am - 10:20am Ward, E LOT50G

**NOTE:** No-cost digital textbooks or textual materials used.

### KINESIOLOGY: INDIVIDUAL

■ **KINI 4A — Badminton - Beginning** **.5 Unit**

Degree Applicable, CSU, UC

(May be taken for option of Letter grade or Pass/NoPass)

**10702 TWTh 4:10pm - 6:00pm Whitlock, M 3-1FL**  
**6 Weeks, Week beginning 06/25/2018 ending 08/02/2018**

**NOTE:** CRN 10702: Class begins T, 6/26/18 and ends Th, 8/2/18. No-cost digital textbooks or textual materials used.

■ **KINI 4B — Badminton - Intermediate** **.5 Unit**

Degree Applicable, CSU, UC

(May be taken for option of Letter grade or Pass/NoPass)

**10703 TWTh 4:10pm - 6:00pm Whitlock, M 3-1FL**  
**6 Weeks, Week beginning 06/25/2018 ending 08/02/2018**

**NOTE:** CRN 10703: Class begins on T, 6/26/18 and ends Th, 8/2/18. No-cost digital textbooks or textual materials used.

■ **KINI 18A — Golf - Beginning** **.5 Unit**

Degree Applicable, CSU, UC

(May be taken for option of Letter grade or Pass/NoPass)

10704 TTh 10:30am - 1:20pm Osbourne, G 45G

**NOTE:** No-cost digital textbooks or textual materials used.

■ **KINI 18B — Golf - Intermediate** **.5 Unit**

Degree Applicable, CSU, UC

(May be taken for option of Letter grade or Pass/NoPass)

Instruction to individuals with previous golf experience. Golf clubs and off site classes required.

10705 TTh 10:30am - 1:20pm Osbourne, G TBA

**NOTE:** No-cost digital textbooks or textual materials used.

■ **KINI 29 — Self Defense and Martial Arts** **.5 Unit**

Degree Applicable, CSU, UC

(May be taken for option of Letter grade or Pass/NoPass)

Basic concepts of self-defense and martial arts.

10709 TWTh 8:00am - 9:50am Rivas, M 27C-201

**NOTE:** No-cost digital textbooks or textual materials used.

10708 TWTh 10:00am - 11:50am Rivera, D 27C-201

**NOTE:** No-cost digital textbooks or textual materials used.

■ **KINI 33A — Kickboxing Beginning** **.5 Unit**

Degree Applicable, CSU, UC

(May be taken for option of Letter grade or Pass/NoPass)

Presents the martial sport of kickboxing. Designed for students with little or no experience

10713 TWTh 12:00pm - 1:50pm Rivas, M 27C-201

**NOTE:** No-cost digital textbooks or textual materials used.

10715 TWTh 1:30pm - 3:20pm Rivera, D 27A-108

**NOTE:** No-cost digital textbooks or textual materials used.

■ **KINI 33B — Kickboxing Intermediate** **.5 Unit**

Degree Applicable, CSU, UC

(May be taken four times for credit)

(May be taken for option of Letter grade or Pass/NoPass)

*Prerequisite: KINI 33A*

Intermediate Kickboxing techniques.

10714 TWTh 12:00pm - 1:50pm Rivas, M 27C-201

**NOTE:** No-cost digital textbooks or textual materials used.

10716 TWTh 1:30pm - 3:20pm Rivera, D 27A-108

**NOTE:** No-cost digital textbooks or textual materials used.

■ **KINI 50A — Yoga** **.5 Unit**

Degree Applicable, CSU, UC

(May be taken for option of Letter grade or Pass/NoPass)

Yoga postures, breathing techniques, and relaxation strategies.

10710 TWTh 8:00am - 9:50am Del Castillo, S 27A-108

**NOTE:** No-cost digital textbooks or textual materials used.

10711 MTW 10:00am - 11:50am Wilder-Mazurie, D 45-1411

**NOTE:** No-cost digital textbooks or textual materials used.

10712 TWTh 3:30pm - 5:20pm Flores, C 27A-108

**NOTE:** No-cost digital textbooks or textual materials used.

### KINESIOLOGY: TEAM SPORT

■ **KINS 2A — Basketball Beginning** **.5 Unit**

Degree Applicable, CSU, UC

(May be taken for option of Letter grade or Pass/NoPass)

Designed to teach skills, fundamentals, rules and strategies for team play in basketball for the beginner.

**10699 TTh 7:00pm - 9:50pm Michel, M 3-1FL**  
**6 Weeks, Week beginning 06/25/2018 ending 08/02/2018**

**NOTE:** CRN 10699: Class begins T, 6/26/18 and end Th, 8/2/17. No-cost digital textbooks or textual materials used.

■ **KINS 2B — Basketball Intermediate** **.5 Unit**

Degree Applicable, CSU, UC

(May be taken for option of Letter grade or Pass/NoPass)

Skills, fundamentals, rules and strategies for team play in basketball for students with previous-experience.

**10700 TTh 7:00pm - 9:50pm Michel, M 3-1FL**  
**6 Weeks, Week beginning 06/25/2018 ending 08/02/2018**

**NOTE:** CRN 10700: Class begins T, 6/26/18 and ends Th, 8/2/18. No-cost digital textbooks or textual materials used.

■ **KINS 24A — Volleyball - Beginning** **.5 Unit**

Degree Applicable, CSU, UC

(May be taken for option of Letter grade or Pass/NoPass)

Techniques and strategies of volleyball including passing, setting, hitting, and serving.

**10706 MW 7:00pm - 9:50pm Lackey, K 3-1FL**

**NOTE:** No-cost digital textbooks or textual materials used.

■ **KINS 24B — Volleyball - Intermediate** **.5 Unit**

Degree Applicable, CSU, UC

(May be taken for option of Letter grade or Pass/NoPass)

**10707 MW 7:00pm - 9:50pm Lackey, K 3-1FL**

**NOTE:** No-cost digital textbooks or textual materials used.

### KINESIOLOGY: THEORY

■ **KIN 3 — First Aid and CPR** **3.0 Units**

(C-ID KIN 101) Degree Applicable, CSU, UC

*Advisory: Eligibility for ENGL 68*

Training in caring for victims of medical emergencies. American Red Cross First Aid and CPR certificates can be earned.

10736 TWTh 7:30am - 10:20am Jackson, C 27A-106

10735 TWTh 10:30am - 1:20pm Todd, J 27A-106

10737 TWTh 1:30pm - 4:20pm Rojas, R 27A-106

■ **KIN 13 — Sports Officiating** **3.0 Units**  
Degree Applicable, CSU, UC  
Rules, regulations and career opportunities of various team and individual sports.  
10738 TWTTh 7:30am - 10:20am STAFF 45-1462

■ **KIN 34 — Fitness for Living** **3.0 Units**  
Degree Applicable, CSU, UC  
Survey and analysis of the components of fitness. Effects of fitness, stress management, nutrition and weight control on health.

10740 TWTTh 7:30am - 10:20am Purcell, R 27A-109  
10741 MTW 10:30am - 1:20pm STAFF 45-1462  
10742 TWTTh 10:30am - 1:20pm Parker, S 27A-109  
10743 TWTTh 1:30pm - 4:20pm STAFF 27A-109  
10739 MTW 7:00pm - 9:50pm Maloney, C 45-1462  
10744 arrange 9 hours Bowen, M ONLINE

**NOTE: CRN 10744 is a Distance Learning Online Class.**

**How to Begin Course:** Log into Canvas through the e-Learning Tools tab in the Mt.SAC portal at [inside.mtsac.edu](http://inside.mtsac.edu). Then click on the Canvas link and then click on the CRN to log into your DL course. **NOTE:** Some courses may not be activated until the start of the term. If you cannot locate your DL course in Canvas when the term starts, contact the professor. **On the first day of classes, log into your DL course to show your "attendance" because not doing so could result in your being dropped from the class for non-attendance.**

**Professor contact info:** Email Professor Melinda Bowen at either: [mbowen@mtsac.edu](mailto:mbowen@mtsac.edu), through Student Detail Schedule or Canvas at MyMtSAC Portal.

**Students must use their Mt.SAC e-mail account and be aware of course commitment and student expectations described at <http://www.mtsac.edu/distancelearning/>**

**To prepare for a successful online learning experience, see helpful short videos at <http://www.mtsac.edu/distancelearning/quiz/>**

10813 arrange 9 hours Knott-Silva, T ONLINE

**NOTE: CRN 10813 is a Distance Learning Online Class.**

**How to Begin Course:** Log into Canvas through the e-Learning Tools tab in the Mt.SAC portal at [inside.mtsac.edu](http://inside.mtsac.edu). Then click on the Canvas link and then click on the CRN to log into your DL course. **NOTE:** Some courses may not be activated until the start of the term. If you cannot locate your DL course in Canvas when the term starts, contact the professor. **On the first day of classes, log into your DL course to show your "attendance" because not doing so could result in your being dropped from the class for non-attendance.**

**Professor contact info:** Email Professor Tamara Knott-Silva at either: [tknottsilva@mtsac.edu](mailto:tknottsilva@mtsac.edu), through Student Detail Schedule or Canvas at MyMtSAC Portal.

**Students must use their Mt.SAC e-mail account and be aware of course commitment and student expectations described at <http://www.mtsac.edu/distancelearning/>**

**To prepare for a successful online learning experience, see helpful short videos at <http://www.mtsac.edu/distancelearning/quiz/>**

■ **KIN 44 — Theory of Coaching** **3.0 Units**  
Degree Applicable, CSU, UC  
Theory of coaching covers the fundamentals of being a successful coach, on and off the field.

10745 MTW 1:30pm - 4:20pm Sanchez, J 45-1462

## LEARNING ASSISTANCE

■ **LERN 48 — Basic Math Skills Review** **3.0 Units**  
Not Degree Applicable

(May be taken for Pass/No Pass Only)

Math fundamentals: whole number and decimal operations with an emphasis on math learning strategies.

10358 MTW 7:30am - 10:20am Robinson, C 6-222

■ **LERN 49 — Math Skills Review** **3.0 Units**  
Not Degree Applicable

(May be taken for Pass/No Pass Only)

*Prerequisite: LERN 48 or passing score on current placement test*

Improves knowledge of basic math. Includes operations and applied problems. Covers math study strategies.

10393 MTWTh 8:00am - 10:05am Hall, M 6-137

**NOTE:** LERN 49 (CRN 10393) is a part of the Pathways Program and is linked to STDY 85A (CRN 10388). **To enroll for Summer 2018 please register for both LERN 49 (CRN 10393) and STDY 85A (CRN 10388).** Your success in this summer program will guarantee your spot in Math 50 and Math 51 in Fall 2018. This class is a part of Math Cohort #1. If you have any questions please email [pathways@mtsac.edu](mailto:pathways@mtsac.edu) or call (909) 274-5703.

10361 MTWTh 10:15am - 12:20pm Ma, J 6-112

10362 MTWTh 10:15am - 12:20pm Walker, L 6-134

10364 MTW 4:30pm - 7:20pm Nazzal, J 6-134

**NOTE:** LERN 49 (CRN 10364) is a part of the Pathways Program and is linked to STDY 85A (CRN 10858). **To enroll for Summer 2018 please register for both LERN 49 (CRN 10364) and STDY 85A (CRN 10858).** Your success in this summer program will guarantee your spot in Math 50 and Math 51 in Fall 2018. This class is a part of Math Cohort #4. If you have any questions please email [pathways@mtsac.edu](mailto:pathways@mtsac.edu) or call (909) 274-5703.

■ **LERN 81 — Improving Writing** **3.0 Units**  
Not Degree Applicable

(May be taken for Pass/No Pass Only)

Develop as a writer through practice and reflection. Improve writing process and product.

10366 MTW 10:30am - 1:20pm Nazzal, J 6-130

10367 MTW 1:30pm - 4:20pm Nazzal, J 6-130

## LEARNING COMMUNITIES

■ **LCOM 80 — Learning Communities: Individual Connections** **1.0 Unit**  
Not Degree Applicable

Explores connections between self, courses, and learning community. Concurrent enrollment in a learning community required.

10374 MW 8:30am - 9:45am Flamenó, B 9C

**NOTE:** CRN 10374 above is designed for students in the Summer Bridge Program. Special approval is needed to enroll in this learning community. For more information, please contact (909)274-5392.

10375 MW 8:30am - 9:45am Lee, E 9C

**NOTE:** CRN 10375 above is designed for students in the Summer Bridge Program. Special approval is needed to enroll in this learning community. For more information, please contact (909)274-5392.

10376 MW 8:30am - 9:45am Espinoza, L 9C

**NOTE:** CRN 10376 above is designed for students in the Summer Bridge Program. Special approval is needed to enroll in this learning community. For more information, please contact (909)274-5392.

10377 MW 8:30am - 9:45am Santacruz, R 9C

**NOTE:** CRN 10377 above is designed for students in the Summer Bridge Program. Special approval is needed to enroll in this learning community. For more information, please contact (909)274-5392.

10380 TTh 8:30am - 9:45am Bachor, A 9C

**NOTE:** CRN 10380 above is designed for students in the Summer Bridge Program. Special approval is needed to enroll in this learning community. For more information, please contact (909)274-5392.

10381 TTh 8:30am - 9:45am Ton, C 9C

**NOTE:** CRN 10381 above is designed for students in the Summer Bridge Program. Special approval is needed to enroll in this learning community. For more information, please contact (909)274-5392.

10382 TTh 8:30am - 9:45am Hart, J 9C

**NOTE:** CRN 10382 above is designed for students in the Summer Bridge Program. Special approval is needed to enroll in this learning community. For more information, please contact (909)274-5392.

10383 TTh 8:30am - 9:45am Ngo, M 9C

**NOTE:** CRN 10383 above is designed for students in the Summer Bridge Program. Special approval is needed to enroll in this learning community. For more information, please contact (909)274-5392.

## MANUFACTURING TECHNOLOGY

**MFG 160 — Introduction to Mechanical Principles** **3.0 Units**  
Degree Applicable

*Prerequisite:* EDT 16 or MFG 110

Mechanical devices, concepts, and principles. Production cards, calipers required. May require field trips.

<b>10763</b>	<b>MTWTh</b>	<b>6:00pm - 7:15pm</b>	<b>Cusolito, A</b>	<b>28B-305</b>
	<b>and MTWTh</b>	<b>7:25pm - 9:30pm</b>	<b>Cusolito, A</b>	<b>28B-305</b>

## MATHEMATICS

**MATH 50 — Pre-Algebra** **3.0 Units**  
Not Degree Applicable

*Prerequisite:* LERN 49 or appropriate placement.

Fundamental principles of mathematics designed to ease the transition from arithmetic to algebra.

10425	MTW	7:30am - 10:20am	STAFF	61-2410
10426	MTW	7:30am - 10:20am	STAFF	61-2414
10427	MTWTh	8:00am - 10:05am	Saravia, W	61-3406

**NOTE:** MATH 50 (CRN 10427) is a part of the Pathways Program and is linked to STDY 85A (CRN 10389). **To enroll for Summer 2018 please register for both MATH 50 (CRN 10427) and STDY 85A (CRN 10389).** Your success in this summer program will guarantee your spot in Math 51 and Math 71 in Fall 2018. This class is a part of Math Cohort #2. If you have any questions please email pathways@mtsac.edu or call (909) 274-5703.

10428	MTWTh	10:15am - 12:20pm	Munro, M	61-2306
-------	-------	-------------------	----------	---------

**NOTE:** CRN 10428 above is designed for students in the Summer Bridge Program. Special approval is needed to enroll in this learning community. For more information, please contact (909)274-5392.

10429	MTW	10:30am - 1:20pm	Saravia, W	61-3415
10430	MTW	10:30am - 1:20pm	Harirchi, M	61-3418
10431	MTW	1:30pm - 4:20pm	Ramirez, C	61-3419
10432	TWTh	1:30pm - 4:20pm	Sun, C	61-3418
<b>10456</b>	<b>TWTh</b>	<b>4:30pm - 7:20pm</b>	<b>Sun, C</b>	<b>61-3418</b>
<b>10457</b>	<b>MTW</b>	<b>7:30pm - 10:20pm</b>	<b>Lam, H</b>	<b>61-3415</b>

**MATH 51 — Elementary Algebra** **4.0 Units**  
Not Degree Applicable

*Prerequisite:* MATH 50 or appropriate placement

An introductory course in algebra.

10433	MTWTh	7:30am - 10:20am	Kirchgraber, A	61-2315
-------	-------	------------------	----------------	---------

**NOTE:** MATH 51 (CRN 10433) is a part of the Pathways Program and is linked to STDY 85A (CRN 10390). **To enroll for Summer 2018 please register for both MATH 51 (CRN 10433) and STDY 85A (CRN 10390).** Your success in this summer program will guarantee your spot in Math 71 and Math 110 in Fall 2018. This class is a part of Math Cohort #3. If you have any questions please email pathways@mtsac.edu or call (909) 274-5703.

10434	MTWTh	7:30am - 10:20am	STAFF	61-3315
10435	MTWTh	7:30am - 10:20am	Harirchi, M	61-3319
10436	MTWTh	7:30am - 10:20am	STAFF	61-3418
10437	MTWTh	10:30am - 1:20pm	Kirchgraber, A	61-2315
10438	MTWTh	10:30am - 1:20pm	Edwards, W	61-2319
10439	MTWTh	10:30am - 1:20pm	Garcia, R	61-3315
10440	MTWTh	10:30am - 1:20pm	Aguilar, J	61-3319

**NOTE:** CRN 10440 above is designed for students in the Summer Bridge Program. Special approval is needed to enroll in this learning community. For more information, please contact (909)274-5392.

10441	MTWTh	1:30pm - 4:20pm	Edwards, W	61-2319
10462	MTWTh	1:30pm - 4:20pm	Johnson, K	61-2418
<b>10536</b>	<b>MTWTh</b>	<b>4:30pm - 7:20pm</b>	<b>Yao, J</b>	<b>61-3315</b>
<b>10537</b>	<b>MTWTh</b>	<b>4:30pm - 7:20pm</b>	<b>Garland, J</b>	<b>61-3319</b>
<b>10538</b>	<b>MTWTh</b>	<b>7:30pm - 10:20pm</b>	<b>Rahman, M</b>	<b>61-3315</b>
<b>10539</b>	<b>MTWTh</b>	<b>7:30pm - 10:20pm</b>	<b>Kim, W</b>	<b>61-3319</b>
<b>10540</b>	<b>MTWTh</b>	<b>7:30pm - 10:20pm</b>	<b>STAFF</b>	<b>61-2302</b>

**MATH 61 — Plane Geometry** **3.0 Units**  
Degree Applicable

*Prerequisite:* MATH 51 or MATH 51B or appropriate placement

Points, lines, polygons and circles; their relationships to each other on plane surfaces; congruence, similarity and area.

10442	MTW	1:30pm - 4:20pm	Garland, J	61-3315
<b>10443</b>	<b>MTW</b>	<b>7:30pm - 10:20pm</b>	<b>Chang, H</b>	<b>61-2319</b>

**MATH 70S — Integrated Intermediate Algebra** **5.0 Units**  
Degree Applicable

*Prerequisite:* MATH 50 or appropriate placement.

Math 70S is an intermediate algebra course that integrates topics from statistics, and is the prerequisite to Math 110S.

10541	MTW	12:30pm - 5:20pm	Lancaster, S	61-2414
-------	-----	------------------	--------------	---------

**MATH 71 — Intermediate Algebra** **5.0 Units**  
Degree Applicable

*Prerequisite:* MATH 51 or MATH 51B or appropriate placement.

Extends concepts from elementary algebra to prepare students for college-level mathematics courses.

10444	MTWTh	7:30am - 11:00am	Rivers, D	61-3414
10445	MTWTh	7:30am - 11:00am	Summers, M	61-2406
10446	MTWTh	7:30am - 11:00am	Takashima, T	61-2310
10447	MTWTh	7:30am - 11:00am	Ong, H	61-2311
10448	MTWTh	7:30am - 11:00am	Wono, K	61-3411
10449	MTWTh	11:10am - 2:40pm	Rivers, D	61-3414
10460	MTWTh	11:10am - 2:40pm	Summers, M	61-2406
10463	MTWTh	11:10am - 2:40pm	Takashima, T	61-2310
10464	MTWTh	11:10am - 2:40pm	Ong, H	61-2311
10469	MTWTh	11:10am - 2:40pm	Nguyen, H	61-3411
10542	MTWTh	2:50pm - 6:20pm	Tamayo, J	61-3410
10543	MTWTh	2:50pm - 6:20pm	Leung, S	61-2311
10544	MTWTh	2:50pm - 6:20pm	Panchal, M	61-3414
<b>10545</b>	<b>MTWTh</b>	<b>6:30pm - 10:00pm</b>	<b>Leung, S</b>	<b>61-3419</b>
<b>10546</b>	<b>MTWTh</b>	<b>6:30pm - 10:00pm</b>	<b>Lee, C</b>	<b>61-3411</b>
<b>10547</b>	<b>MTWTh</b>	<b>6:30pm - 10:20pm</b>	<b>STAFF</b>	<b>61-3410</b>
<b>10548</b>	<b>MTWTh</b>	<b>6:30pm - 10:20pm</b>	<b>STAFF</b>	<b>61-2311</b>
<b>10549</b>	<b>MTWTh</b>	<b>6:30pm - 10:20pm</b>	<b>STAFF</b>	<b>61-3414</b>

**MATH 110 — Elementary Statistics** **3.0 Units**  
Degree Applicable, CSU, UC

*Prerequisite:* MATH 71 or MATH 71X or MATH 71B or appropriate placement

Descriptive and inferential statistics and probability with emphasis on statistical methods.

10870	MTW	7:30am - 10:20am	Humaciu, M	61-2419
10871	MTW	7:30am - 10:20am	Pachas, E	61-3306
10872	MTW	7:30am - 10:20am	Huang, L	61-3310
10873	MTW	7:30am - 10:20am	Garcia, R	61-3415
10874	MTW	10:30am - 1:20pm	Humaciu, M	61-2419
10875	MTW	10:30am - 1:20pm	Pachas, E	61-3306
10876	MTW	10:30am - 1:20pm	Huang, L	61-3310
10877	MTW	1:30pm - 4:20pm	Faradineh, R	61-2419
10878	MTW	1:30pm - 4:20pm	Chen, D	61-3306
10879	MTW	1:30pm - 4:20pm	Alvarado, N	61-3310
<b>10880</b>	<b>MTW</b>	<b>4:30pm - 7:20pm</b>	<b>Faradineh, R</b>	<b>61-2419</b>
<b>10881</b>	<b>MTW</b>	<b>4:30pm - 7:20pm</b>	<b>Kim, M</b>	<b>61-3306</b>
<b>10882</b>	<b>MTW</b>	<b>4:30pm - 7:20pm</b>	<b>Nguyen, C</b>	<b>61-3310</b>
<b>10883</b>	<b>MTW</b>	<b>7:30pm - 10:20pm</b>	<b>Hernandez-Saul, C</b>	<b>61-2419</b>
<b>10884</b>	<b>MTW</b>	<b>7:30pm - 10:20pm</b>	<b>STAFF</b>	<b>61-3306</b>
<b>10885</b>	<b>MTW</b>	<b>7:30pm - 10:20pm</b>	<b>STAFF</b>	<b>61-3310</b>

**MATH 110S — Integrated Statistics** **5.0 Units**  
Degree Applicable, CSU, UC

*Prerequisite:* MATH 70S

MATH 110S is an elementary statistics course, covering typical topics from descriptive and inferential statistics.

10550	MTW	5:30pm - 10:20pm	Lancaster, S	61-2414
-------	-----	------------------	--------------	---------

## MATHEMATICS COURSE SEQUENCES

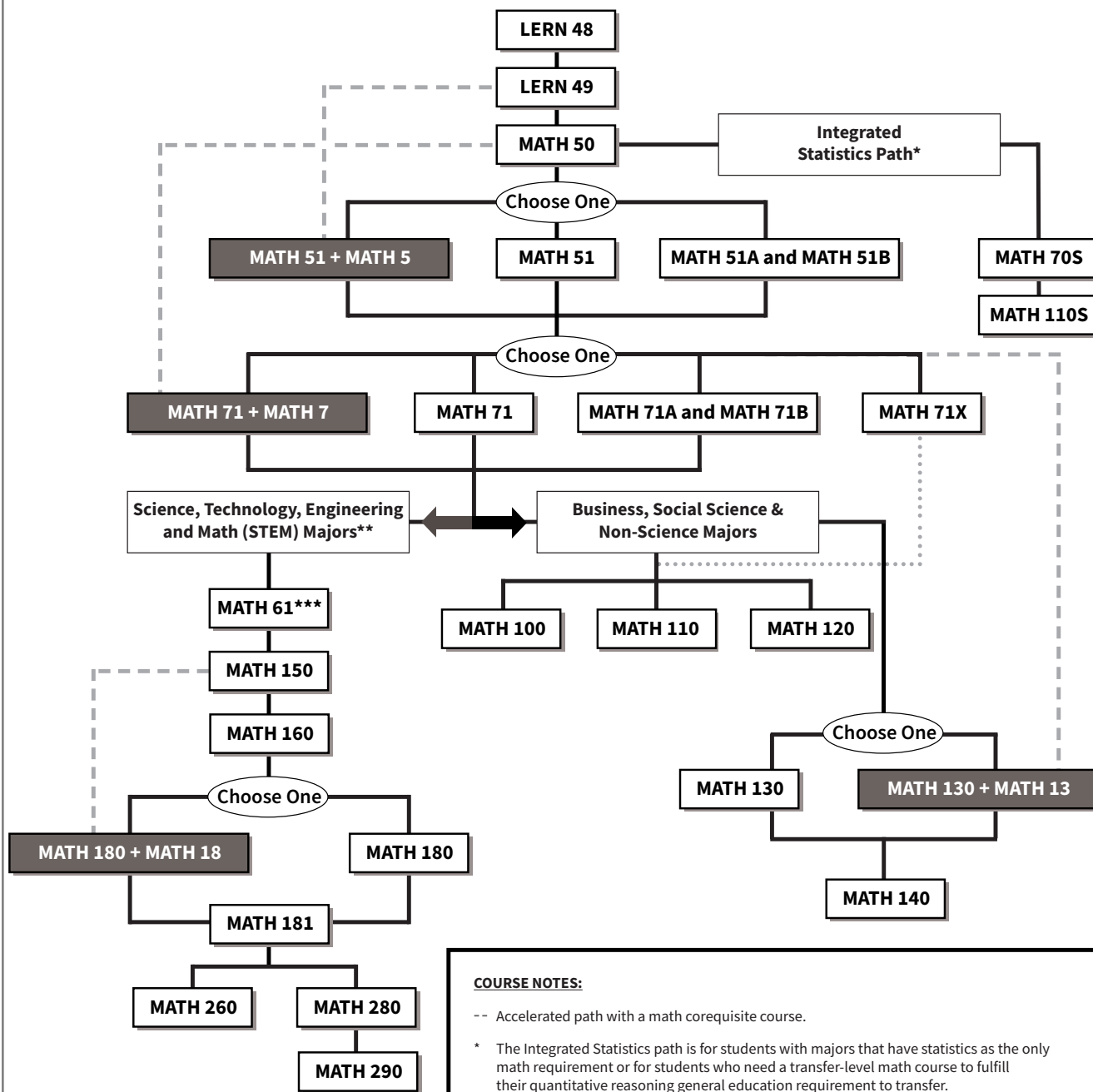

**COURSE NOTES:**

- Accelerated path with a math corequisite course.
- \* The Integrated Statistics path is for students with majors that have statistics as the only math requirement or for students who need a transfer-level math course to fulfill their quantitative reasoning general education requirement to transfer.
- \*\* The STEM path may also include other majors whose transfer universities require these courses.
- \*\*\* The Math 61 requirement can be waived with passing grades (C or better) in 1 year of High School Geometry or passing score on Geometry Competency Exam. Math 61 and 71 (or 71A) can be taken in any order following Math 51.

**PLACEMENT NOTES:**

Students may place directly into Math 180, 181, or 280 with the proper AP or IB exam scores.

Please visit the Math Department (Bldg. 61-Rm.1622) or go to [www.mtsac.edu/math](http://www.mtsac.edu/math) for additional information. For information regarding placement or assessment, please go to the Assessment Center (Bldg. 9B) or the Counseling Department (Bldg. 9B).

**■ MATH 130 — College Algebra** **4.0 Units**  
Degree Applicable, CSU, UC

*Prerequisite: MATH 71 or MATH 71B or appropriate placement*  
College-level algebra course.

10409	MTWTh	7:30am - 10:20am	Butenko, A	61-3302
10410	MTWTh	7:30am - 10:20am	STAFF	61-3410
10411	MTWTh	10:30am - 1:20pm	Butenko, A	61-3302
10412	MTWTh	1:30pm - 4:20pm	Kim, M	61-3302
<b>10458</b>	<b>MTWTh</b>	<b>4:30pm - 7:20pm</b>	<b>Lam, A</b>	<b>61-3302</b>
<b>10470</b>	<b>MTWTh</b>	<b>7:30pm - 10:20pm</b>	<b>Lam, A</b>	<b>61-3302</b>

**■ MATH 140 — Calculus for Business** **4.0 Units**  
Degree Applicable, CSU, UC

*Prerequisite: MATH 130 or MATH 160 or appropriate placement*  
Calculus for business, social science, and non-science majors.

10413	MTWTh	10:30am - 1:20pm	Tamayo, J	61-3410
-------	-------	------------------	-----------	---------

**■ MATH 150 — Trigonometry** **3.0 Units**  
Degree Applicable, CSU

*Prerequisite: MATH 71 or MATH 71B or appropriate placement AND MATH 61 or passing score on current geometry competency test.*  
Trigonometric and inverse trigonometric functions, including graphs and identities.

10414	MTW	7:30am - 10:20am	Eleuteri, R	61-3419
10415	MTW	10:30am - 1:20pm	Eleuteri, R	61-3419
10416	MTW	1:30pm - 4:20pm	Kojima, T	61-2315
<b>10417</b>	<b>MTW</b>	<b>4:30pm - 7:20pm</b>	<b>Kojima, T</b>	<b>61-2315</b>
<b>10551</b>	<b>MTW</b>	<b>7:30pm - 10:20pm</b>	<b>Yao, J</b>	<b>61-2418</b>

**■ MATH 160 — Precalculus Mathematics** **4.0 Units**  
Degree Applicable, CSU, UC

*Prerequisite: MATH 150 or appropriate placement*  
Prepares students for the calculus sequence.

10418	MTWTh	7:30am - 10:20am	Peng, G	61-2418
10419	MTWTh	10:30am - 1:20pm	Peng, G	61-2418
<b>10420</b>	<b>MTWTh</b>	<b>7:30pm - 10:20pm</b>	<b>Menjivar, J</b>	<b>61-3418</b>

**■ MATH 180 — Calculus and Analytic Geometry** **4.0 Units**  
Degree Applicable, CSU, UC

*Prerequisite: MATH 160 or appropriate placement*  
Differential and integral calculus with applications.

10421	MTWTh	7:30am - 10:20am	Nguyen, H	61-2319
10422	MTWTh	10:30am - 1:20pm	Griffith, H	61-2302
10423	MTW	12:30pm - 4:20pm	Sholars, J	61-2410
10465	MTW	12:30pm - 4:20pm	Tran, F	61-2306
<b>10552</b>	<b>MTW</b>	<b>5:30pm - 9:20pm</b>	<b>Tran, F</b>	<b>61-2306</b>

**■ MATH 181 — Calculus and Analytic Geometry** **4.0 Units**  
Degree Applicable, CSU, UC

*Prerequisite: MATH 180*  
Differential and integral calculus with infinite series and applications.

10424	MTWTh	1:30pm - 4:20pm	Griffith, H	61-2302
<b>10481</b>	<b>MTW</b>	<b>5:30pm - 9:20pm</b>	<b>Sholars, J</b>	<b>61-2410</b>

### MEDICAL TERMINOLOGY

**■ MEDI 90 — Medical Terminology** **3.0 Units**  
Degree Applicable, CSU

Medical terminology used in various allied health fields.

10019	TWTh	7:30am - 10:20am	Graffeo, N	67A-138
10059	TWTh	7:30am - 10:20am	Haines, M	67A-206
10026	TWTh	10:30am - 1:20pm	Haines, M	67A-150
<b>10042</b>	<b>TWTh</b>	<b>4:30pm - 7:20pm</b>	<b>Graffeo, N</b>	<b>67A-216</b>

### MENTAL HEALTH/PSYCHIATRIC TECHNICIAN

**■ MENT 40 — Introduction to Interviewing and Counseling** **3.0 Units**  
Not Degree Applicable

10003	MT	11:00am - 3:15pm	James-Perez, S	67A-233
-------	----	------------------	----------------	---------

**■ MENT 58D — Advanced Medical-Surgical Nursing and Pharmacology for PT** **4.0 Units**  
Degree Applicable

*Prerequisite: MENT 56, MENT 56L*  
*Corequisite: MENT 58L*  
Disease processes affecting body systems; etiology; nursing care; study of drugs: administration, dose calculations.

10004	MT	8:00am - 11:05am	Reyes, M	67A-215
and	MT	12:00pm - 3:05pm	Gilbert, C	67A-215
10035	MT	8:00am - 11:05am	Tull, A	67A-205
and	MT	12:00pm - 3:05pm	Gonzalez, G	67A-205

**■ MENT 58L — Advanced Medical-Surgical Nursing for Psychiatric Technicians Clinical** **1.5 Units**  
Degree Applicable

(May be taken for Pass/No Pass Only)  
*Prerequisite: MENT 56 and MENT 56L*  
*Corequisite: MENT 58D*

10005	WTh	7:00am - 11:50am	Reyes, M	HOSP
and	WTh	12:30pm - 3:20pm	Reyes, M	HOSP
10006	WTh	7:00am - 11:50am	Tull, A	HOSP
and	WTh	12:30pm - 3:20pm	Tull, A	HOSP
10036	WTh	7:00am - 11:50am	Yates, S	HOSP
and	WTh	12:30pm - 3:20pm	Yates, S	HOSP

**■ MENT 70 — Introduction to Psychiatric Technology** **1.5 Units**  
Degree Applicable

*Prerequisite: Admission to Psychiatric Technician Program*  
*Corequisite: MENT 70L*

10007	MT	8:00am - 10:15am	Badre, A	67A-233
10008	MT	8:00am - 10:15am	James-Perez, S	67A-225

**■ MENT 70L — Introduction to Psychiatric Technology Clinical Technicians** **2.0 Units**  
Degree Applicable

(May be taken for Pass/No Pass Only)  
*Corequisite: MENT 70*

10009	WThF	8:00am - 12:05pm	James-Perez, S	HOSP
and	WThF	12:30pm - 2:35pm	James-Perez, S	HOSP
10010	WThF	8:00am - 12:05pm	Felten, A	HOSP
and	WThF	12:30pm - 2:35pm	Felten, A	HOSP
10011	WThF	8:00am - 12:05pm	Nixon, B	HOSP
and	WThF	12:30pm - 2:35pm	Nixon, B	HOSP
10048	WThF	8:00am - 12:05pm	Wren, S	HOSP
and	WThF	12:30pm - 2:35pm	Wren, S	HOSP

### MICROBIOLOGY

**■ MICR 22 — Microbiology** **4.0 Units**  
Degree Applicable, CSU, UC

*Prerequisite: CHEM 10 or CHEM 40*  
*Advisory: BIOL 1 or BIOL 4 or BIOL 4H*  
Fundamental concepts of microbiology including viruses, bacteria, fungi, protozoa and parasitic worms.

10512	MTWTh	8:00am - 10:05am	Spitzer, J	60-2506
and	MTWTh	10:15am - 12:20pm	Spitzer, J	7-1104
10513	MTWTh	10:15am - 12:20pm	Spitzer, J	7-1104
and	MTWTh	12:50pm - 2:55pm	Spitzer, J	60-2506
10527	MTWTh	10:25am - 12:30pm	Kaur, R	60-2506
and	MTWTh	12:50pm - 2:55pm	Kaur, R	7-1104
10514	MTWTh	12:50pm - 2:55pm	Kaur, R	7-1104
and	MTWTh	3:15pm - 5:20pm	Kaur, R	60-2506

### MUSIC

**■ MUS 7 — Fundamentals of Music** **3.0 Units**  
(C-ID MUS 110) Degree Applicable, CSU, UC  
Introduction to music notation and the elements of music.

10675	MTW	7:30am - 10:20am	Tomlinson, R	2-M117
10676	MTW	10:30am - 1:20pm	Myers-Mc Kenzie, L	2-M119

**NOTE:** CRN 10676: No-cost digital textbooks or textual materials used



**■ MUS 12 — History of Jazz** **3.0 Units**

Degree Applicable, CSU, UC

*Advisory: Eligibility for ENGL 68.*

A survey of jazz as a significant American art form from its roots in African music to the present.

10661 MTW 10:30am - 1:20pm Harrison, L 2-M107

**NOTE:** CRN 10661: No-cost digital textbooks or textual materials used

10662 MTW 1:30pm - 4:20pm Stier, G 2-M104

**NOTE:** CRN 10662: No-cost digital textbooks or textual materials used

**■ MUS 13 — Introduction to Music Appreciation** **3.0 Units**

(C-ID MUS 100) Degree Applicable, CSU, UC

Western music from the medieval period through the 21st century. Attending at least one live concert is required.

10980 MTW 10:30am - 1:20pm STAFF 2-M104

**NOTE:** CRN 10980: No-cost digital textbooks or textual materials used

10668 MTW 1:30pm - 4:20pm Anastasia, S 2-M107

**NOTE:** CRN 10668: No-cost digital textbooks or textual materials used

10663 arrange 9 hours Marston, K ONLINE

**NOTE:** CRN 10663 is a Distance Learning Online Class.

**How to Begin Course:** Log into Canvas through the e-Learning Tools tab in the Mt.SAC portal at [inside.mtsac.edu](http://inside.mtsac.edu). Then click on the Canvas link and then click on the CRN to log into your DL course. **NOTE:** Some courses may not be activated until the start of the term. If you cannot locate your DL course in Canvas when the term starts, contact the professor. **On the first day of classes, log into your DL course to show your "attendance" because not doing so could result in your being dropped from the class for non-attendance.**

**Professor contact info:** Email Professor Marston at either: [kmarston1@mtsac.edu](mailto:kmarston1@mtsac.edu), through Student Detail Schedule or Canvas at MyMt-SAC Portal.

**Students must use their Mt.SAC e-mail account and be aware of course commitment and student expectations described at <http://www.mtsac.edu/distancelearning/>**

**To prepare for a successful online learning experience, see helpful short videos at <http://www.mtsac.edu/distancelearning/quiz/>**

CRN: 10663 No-cost digital textbooks or textual materials used

10665 9 hours Marston, K

**NOTE:** CRN 10665 is a Distance Learning Online Class.

**How to Begin Course:** Log into Canvas through the e-Learning Tools tab in the Mt.SAC portal at [inside.mtsac.edu](http://inside.mtsac.edu). Then click on the Canvas link and then click on the CRN to log into your DL course. **NOTE:** Some courses may not be activated until the start of the term. If you cannot locate your DL course in Canvas when the term starts, contact the professor. **On the first day of classes, log into your DL course to show your "attendance" because not doing so could result in your being dropped from the class for non-attendance.**

**Professor contact info:** Email Professor Marston at either: [kmarston1@mtsac.edu](mailto:kmarston1@mtsac.edu), through Student Detail Schedule or Canvas at MyMt-SAC Portal.

**Students must use their Mt.SAC e-mail account and be aware of course commitment and student expectations described at <http://www.mtsac.edu/distancelearning/>**

**To prepare for a successful online learning experience, see helpful short videos at <http://www.mtsac.edu/distancelearning/quiz/>**

CRN 10665: No-cost digital textbooks or textual materials used

10666 9 hours Cahow, M

**NOTE:** CRN 10666 is a Distance Learning Online Class.

**How to Begin Course:** Log into Canvas through the e-Learning Tools tab in the Mt.SAC portal at [inside.mtsac.edu](http://inside.mtsac.edu). Then click on the Canvas link and then click on the CRN to log into your DL course. **NOTE:** Some courses may not be activated until the start of the term. If you cannot locate your DL course in Canvas when the term starts, contact the professor. **On the first day of classes, log into your DL course to show your "attendance" because not doing so could result in your being dropped from the class for non-attendance.**

**Professor contact info:** Email Professor Cahow at either: [mcahow@mtsac.edu](mailto:mcahow@mtsac.edu), through Student Detail Schedule or Canvas at MyMtSAC Portal.

**Students must use their Mt.SAC e-mail account and be aware of course commitment and student expectations described at <http://www.mtsac.edu/distancelearning/>**

**To prepare for a successful online learning experience, see helpful short videos at <http://www.mtsac.edu/distancelearning/quiz/>**

CRN 10666: No-cost digital textbooks or textual materials used

10667 arrange 9 hours Cahow, M ONLINE

**NOTE:** CRN 10667 is a Distance Learning Online Class.

**How to Begin Course:** Log into Canvas through the e-Learning Tools tab in the Mt.SAC portal at [inside.mtsac.edu](http://inside.mtsac.edu). Then click on the Canvas link and then click on the CRN to log into your DL course. **NOTE:** Some courses may not be activated until the start of the term. If you cannot locate your DL course in Canvas when the term starts, contact the professor. **On the first day of classes, log into your DL course to show your "attendance" because not doing so could result in your being dropped from the class for non-attendance.**

**Professor contact info:** Email Professor Cahow at either: [mcahow@mtsac.edu](mailto:mcahow@mtsac.edu), through Student Detail Schedule or Canvas at MyMtSAC Portal.

**Students must use their Mt.SAC e-mail account and be aware of course commitment and student expectations described at <http://www.mtsac.edu/distancelearning/>**

**To prepare for a successful online learning experience, see helpful short videos at <http://www.mtsac.edu/distancelearning/quiz/>**

CRN 10667: No-cost digital textbooks or textual materials used

**■ MUS 15 — Rock Music History and Appreciation** **3.0 Units**

Degree Applicable, CSU, UC

Historical survey of rock music from its beginnings in the early 1950s to the present.

10669 MTWTh 8:00am - 10:05am STAFF 2-M119

**NOTE:** CRN 10669: No-cost digital textbooks or textual materials used

10670 MTW 1:30pm - 4:20pm Martin, M TBA

**NOTE:** CRN 10670: No-cost digital textbooks or textual materials used

10671 MTW 4:30pm - 7:20pm Alverson, D 2-M119

**NOTE:** CRN 10671: No-cost digital textbooks or textual materials used

**■ MUS 17A — Elementary Piano** **1.0 Unit**

Degree Applicable, CSU, UC

Reading and performance of piano literature. No prior musical experience is required.

10672 MTWTh 2:45pm - 4:50pm Leung, M 2-M102

**■ MUS 20A — Elementary Voice** **1.0 Unit**

Degree Applicable, CSU, UC

Group singing instruction with an emphasis on breathing and posture, performance techniques, and vocal quality.

10673 MTWTh 2:45pm - 4:50pm Harrison, L 2-M108

**NOTE:** CRN 10673: No-cost digital textbooks or textual materials used

**■ MUS 23A — Elementary Guitar** **1.0 Unit**

Degree Applicable, CSU, UC

Acoustic guitar playing, note reading, strumming, finger picking, and improvisation. Students must furnish their own guitars.

10674 MTWTh 12:30pm - 2:35pm Alverson, D 2-M101

■ **MUS 31 — Concert Choir** **1.5 Units**  
Degree Applicable, CSU, UC

(May be taken four times for credit)

*Prerequisite: Admission by audition*

Large mixed choral ensemble. Attendance at performances including those off-site is required. Auditions held first week.

10977 MTWTh 10:00am - 12:50pm Rogers, B 2-M108

**NOTE:** CRN: 10977 No-cost digital textbooks or textual materials used.

### NURSING

■ **NURS 20 — Nursing Work Experience Program** **1.0 Unit**  
Not Degree Applicable

(May be taken for Pass/No Pass Only)

*Prerequisite: Compliance with Work Experience regulations as designated in the College Catalog. Current satisfactory status in the Nursing Program*

10018 arrange 12.5 hours STAFF HOSP

**NOTE:** On-the-job experience at an approved work site. 75 paid or 60 non-paid hours required for each unit of credit. This is a Special Approval course, please contact the Nursing Office at 909-274-4560 for registration information.

### NUTRITION AND FOOD

■ **NF 10 — Nutrition for Health and Wellness** **3.0 Units**  
Degree Applicable, CSU

*Prerequisite: Eligibility for ENGL 68*

Principles of nutrition and their relationship to optimum health and well-being. Course is intended for non-health science majors.

10297 TTh 7:30am - 11:45am Berenji, N 78-1150

10310 TTh 12:20pm - 4:50pm Alvarado, A 78-1150

**You are what you eat . . .  
Make a HEALTHIER you!**

**Take a  
Nutrition and Foods  
class to learn how!**

**NF10: Nutrition for  
Personal Health and Wellness**

**NF25: Essentials  
of Nutrition**

**REGISTER  
TODAY!**

**3 UNITS  
Meets Area E General  
Education Requirements**

■ **NF 25 — Introduction to Nutrition Science** **3.0 Units**  
(C-ID NUTR 110)  
Degree Applicable, CSU, UC

*Prerequisite: Eligibility for ENGL 68*

Scientific concepts of nutrition related to the function of nutrients and current health issues with emphasis on individual needs.

10352 MW 12:20pm - 4:50pm Alvarado, A 78-1130

10335 T 12:20pm - 2:40pm Basile, T 78-1130

and arrange 6.5 hours Basile, T

**NOTE:** CRN 10335 is a **Hybrid Class** taught partially online with Scheduled Meetings on Campus.

**How to Begin Course:** Log into Canvas through the e-Learning Tools tab in the Mt.SAC portal at [inside.mtsac.edu](http://inside.mtsac.edu). Then click on the Canvas link and then click on the CRN to log into your DL course. **NOTE:** Some courses may not be activated until the start of the term. If you cannot locate your DL course in Canvas when the term starts, contact the professor. **On the first day of classes, log into your DL course to show your "attendance" because not doing so could result in your being dropped from the class for non-attendance.**

**Professor contact info:** Email Professor Basile at either: [TBasile@mtsac.edu](mailto:TBasile@mtsac.edu), through Student Detail Schedule or Canvas at MyMtSAC Portal.

**Students must use their Mt.SAC e-mail account and be aware of course commitment and student expectations described at <http://www.mtsac.edu/distancelearning/>**

**To prepare for a successful online learning experience, see helpful short videos at <http://www.mtsac.edu/distancelearning/quiz/>**

10336 arrange 9 hours Basile, T ONLINE

**NOTE:** CRN 10336 is a **Distance Learning Online Class**.

**How to Begin Course:** Log into Canvas through the e-Learning Tools tab in the Mt.SAC portal at [inside.mtsac.edu](http://inside.mtsac.edu). Then click on the Canvas link and then click on the CRN to log into your DL course. **NOTE:** Some courses may not be activated until the start of the term. If you cannot locate your DL course in Canvas when the term starts, contact the professor. **On the first day of classes, log into your DL course to show your "attendance" because not doing so could result in your being dropped from the class for non-attendance.**

**Professor contact info:** Email Professor Basile at either: [TBasile@mtsac.edu](mailto:TBasile@mtsac.edu), through Student Detail Schedule or Canvas at MyMtSAC Portal.

**Students must use their Mt.SAC e-mail account and be aware of course commitment and student expectations described at <http://www.mtsac.edu/distancelearning/>**

**To prepare for a successful online learning experience, see helpful short videos at <http://www.mtsac.edu/distancelearning/quiz/>**

### OCEANOGRAPHY

■ **OCEA 10 — Introduction to Oceanography** **3.0 Units**  
Degree Applicable, CSU, UC

Geological, chemical, physical, and biological aspects of the Earth's ocean.

10471 TWTh 10:30am - 1:20pm Ellaboudy, A 60-1511

10479 TWTh 1:30pm - 4:20pm Neves, D 11-2209

10779 TWTh 7:00pm - 9:50pm Smith, L 60-1511

■ **OCEA 10L — Introduction to Oceanography Laboratory** **1.0 Unit**  
Degree Applicable, CSU, UC

*Corequisite: OCEA 10 or OCEA 10H (May have been taken previously)*

Laboratory applications and problem-solving in oceanography.

10472 TWTh 1:30pm - 4:20pm Ellaboudy, A 60-1511

### PARALEGAL

■ **PLGL 39 — Contract Law** **3.0 Units**  
Degree Applicable, CSU

Laws relating to the formation of contracts, Statute of Frauds, third-party rights, breach of contract, remedies, and discharge.

10284 TTh 5:10pm - 9:25pm Sweetman, S 78-3120

## PHILOSOPHY

### ■ PHIL 3 — Introduction to Logic 3.0 Units

Degree Applicable, CSU, UC

*Prerequisite: Eligibility for ENGL 68*

Use of arguments in ordinary discourse and in academic disciplines with particular focus on deductive logic.

10069 TWTh 10:30am - 1:20pm Grey, G 26A-3630

**NOTE: No cost digital textbooks or textual materials used.**

10127 arrange 9 hours Mc Gruder, C ONLINE

**NOTE: CRN 10127 is a Distance Learning Online Class.**

**How to Begin Course:** Log into Canvas through the e-Learning Tools tab in the Mt.SAC portal at [inside.mtsac.edu](http://inside.mtsac.edu). Then click on the Canvas link and then click on the CRN to log into your DL course. **NOTE:** Some courses may not be activated until the start of the term. If you cannot locate your DL course in Canvas when the term starts, contact the professor. **On the first day of classes, log into your DL course to show your "attendance" because not doing so could result in your being dropped from the class for non-attendance.**

**Professor contact info:** Email Professor McGruder at either: CMcGruder@mtsac.edu, through Student Detail Schedule or Canvas at MyMtSAC Portal.

**Students must use their Mt.SAC e-mail account and be aware of course commitment and student expectations described at <http://www.mtsac.edu/distancelearning/>**

**To prepare for a successful online learning experience, see helpful short videos at <http://www.mtsac.edu/distancelearning/quiz/>**

10213 arrange 9 hours Mc Gruder, C ONLINE

**NOTE: CRN 10213 is a Distance Learning Online Class.**

**How to Begin Course:** Log into Canvas through the e-Learning Tools tab in the Mt.SAC portal at [inside.mtsac.edu](http://inside.mtsac.edu). Then click on the Canvas link and then click on the CRN to log into your DL course. **NOTE:** Some courses may not be activated until the start of the term. If you cannot locate your DL course in Canvas when the term starts, contact the professor. **On the first day of classes, log into your DL course to show your "attendance" because not doing so could result in your being dropped from the class for non-attendance.**

**Professor contact info:** Email Professor McGruder at either: CMcGruder@mtsac.edu, through Student Detail Schedule or Canvas at MyMtSAC Portal.

**Students must use their Mt.SAC e-mail account and be aware of course commitment and student expectations described at <http://www.mtsac.edu/distancelearning/>**

**To prepare for a successful online learning experience, see helpful short videos at <http://www.mtsac.edu/distancelearning/quiz/>**

10243 arrange 9 hours Mc Gruder, C ONLINE

**NOTE: CRN 10243 is a Distance Learning Online Class.**

**How to Begin Course:** Log into Canvas through the e-Learning Tools tab in the Mt.SAC portal at [inside.mtsac.edu](http://inside.mtsac.edu). Then click on the Canvas link and then click on the CRN to log into your DL course. **NOTE:** Some courses may not be activated until the start of the term. If you cannot locate your DL course in Canvas when the term starts, contact the professor. **On the first day of classes, log into your DL course to show your "attendance" because not doing so could result in your being dropped from the class for non-attendance.**

**Professor contact info:** Email Professor McGruder at either: CMcGruder@mtsac.edu, through Student Detail Schedule or Canvas at MyMtSAC Portal.

**Students must use their Mt.SAC e-mail account and be aware of course commitment and student expectations described at <http://www.mtsac.edu/distancelearning/>**

**To prepare for a successful online learning experience, see helpful short videos at <http://www.mtsac.edu/distancelearning/quiz/>**

### ■ PHIL 5 — Introduction to Philosophy

3.0 Units

(C-ID PHIL 100) Degree Applicable, CSU, UC

*Prerequisite: Eligibility for ENGL 68*

Philosophical ideas concerning knowledge, reality, and values.

10152 TWTh 7:30am - 10:20am Lape, E 26D-2230

10153 TWTh 10:30am - 1:20pm Haney, R 26A-2871

10199 TWTh 10:30am - 1:20pm Merward III, C 26A-1690

**NOTE: No cost digital textbooks or textual materials used.**

10206 TWTh 1:30pm - 4:20pm Alexander, E 26D-2230

10128 arrange 9 hours Lane, D ONLINE

**NOTE: CRN 10128 is a Distance Learning Online Class.**

**How to Begin Course:** Log into Canvas through the e-Learning Tools tab in the Mt.SAC portal at [inside.mtsac.edu](http://inside.mtsac.edu). Then click on the Canvas link and then click on the CRN to log into your DL course. **NOTE:** Some courses may not be activated until the start of the term. If you cannot locate your DL course in Canvas when the term starts, contact the professor. **On the first day of classes, log into your DL course to show your "attendance" because not doing so could result in your being dropped from the class for non-attendance.**

**Professor contact info:** Email Professor Lane at either: DLane@mtsac.edu, through Student Detail Schedule or Canvas at MyMtSAC Portal.

**Students must use their Mt.SAC e-mail account and be aware of course commitment and student expectations described at <http://www.mtsac.edu/distancelearning/>**

**To prepare for a successful online learning experience, see helpful short videos at <http://www.mtsac.edu/distancelearning/quiz/>**

**No cost digital textbooks or textual materials used.**

10129 arrange 9 hours Lane, D ONLINE

**NOTE: CRN 10129 is a Distance Learning Online Class.**

**How to Begin Course:** Log into Canvas through the e-Learning Tools tab in the Mt.SAC portal at [inside.mtsac.edu](http://inside.mtsac.edu). Then click on the Canvas link and then click on the CRN to log into your DL course. **NOTE:** Some courses may not be activated until the start of the term. If you cannot locate your DL course in Canvas when the term starts, contact the professor. **On the first day of classes, log into your DL course to show your "attendance" because not doing so could result in your being dropped from the class for non-attendance.**

**Professor contact info:** Email Professor Lane at either: DLane@mtsac.edu, through Student Detail Schedule or Canvas at MyMtSAC Portal.

**Students must use their Mt.SAC e-mail account and be aware of course commitment and student expectations described at <http://www.mtsac.edu/distancelearning/>**

**To prepare for a successful online learning experience, see helpful short videos at <http://www.mtsac.edu/distancelearning/quiz/>**

**No cost digital textbooks or textual materials used.**

10253 arrange 9 hours Wolde-Yohannes, S ONLINE

**NOTE: CRN 10253 is a Distance Learning Online Class.**

**How to Begin Course:** Log into Canvas through the e-Learning Tools tab in the Mt.SAC portal at [inside.mtsac.edu](http://inside.mtsac.edu). Then click on the Canvas link and then click on the CRN to log into your DL course. **NOTE:** Some courses may not be activated until the start of the term. If you cannot locate your DL course in Canvas when the term starts, contact the professor. **On the first day of classes, log into your DL course to show your "attendance" because not doing so could result in your being dropped from the class for non-attendance.**

**Professor contact info:** Email Professor Wolde-Yohannes at either: SWoldeYohannes@mtsac.edu, through Student Detail Schedule or Canvas at MyMtSAC Portal.

**Students must use their Mt.SAC e-mail account and be aware of course commitment and student expectations described at <http://www.mtsac.edu/distancelearning/>**

**To prepare for a successful online learning experience, see helpful short videos at <http://www.mtsac.edu/distancelearning/quiz/>**

10255 arrange 9 hours Wolde-Yohannes, S ONLINE  
**NOTE: CRN 10255 is a Distance Learning Online Class.**

**How to Begin Course:** Log into Canvas through the e-Learning Tools tab in the Mt.SAC portal at [inside.mtsac.edu](http://inside.mtsac.edu). Then click on the Canvas link and then click on the CRN to log into your DL course. **NOTE:** Some courses may not be activated until the start of the term. If you cannot locate your DL course in Canvas when the term starts, contact the professor. **On the first day of classes, log into your DL course to show your "attendance" because not doing so could result in your being dropped from the class for non-attendance.**

**Professor contact info:** Email Professor Wolde-Yohannes at either: SWoldeYohannes@mtsac.edu, through Student Detail Schedule or Canvas at MyMtSAC Portal.

**Students must use their Mt.SAC e-mail account and be aware of course commitment and student expectations described at <http://www.mtsac.edu/distancelearning/>**

**To prepare for a successful online learning experience, see helpful short videos at <http://www.mtsac.edu/distancelearning/quiz/>**

■ **PHIL 8 — Critical Thinking** **3.0 Units**  
 Degree Applicable, CSU, UC

Effective use of critical thinking in contemporary living, including recognizing faulty arguments and avoiding common fallacies.

10070 TWTh 1:30pm - 4:20pm Lloyd, A 26A-1690  
 10130 arrange 9 hours Lane, D ONLINE

**NOTE: CRN 10130 is a Distance Learning Online Class.**

**How to Begin Course:** Log into Canvas through the e-Learning Tools tab in the Mt.SAC portal at [inside.mtsac.edu](http://inside.mtsac.edu). Then click on the Canvas link and then click on the CRN to log into your DL course. **NOTE:** Some courses may not be activated until the start of the term. If you cannot locate your DL course in Canvas when the term starts, contact the professor. **On the first day of classes, log into your DL course to show your "attendance" because not doing so could result in your being dropped from the class for non-attendance.**

**Professor contact info:** Email Professor Lane at either: DLane@mtsac.edu, through Student Detail Schedule or Canvas at MyMtSAC Portal.

**Students must use their Mt.SAC e-mail account and be aware of course commitment and student expectations described at <http://www.mtsac.edu/distancelearning/>**

**To prepare for a successful online learning experience, see helpful short videos at <http://www.mtsac.edu/distancelearning/quiz/>**

**No cost digital textbooks or textual materials used.**

10265 arrange 9 hours Park, J ONLINE  
**NOTE: CRN 10265 is a Distance Learning Online Class.**

**How to Begin Course:** Log into Canvas through the e-Learning Tools tab in the Mt.SAC portal at [inside.mtsac.edu](http://inside.mtsac.edu). Then click on the Canvas link and then click on the CRN to log into your DL course. **NOTE:** Some courses may not be activated until the start of the term. If you cannot locate your DL course in Canvas when the term starts, contact the professor. **On the first day of classes, log into your DL course to show your "attendance" because not doing so could result in your being dropped from the class for non-attendance.**

**Professor contact info:** Email Professor Park at either: JSPark@mtsac.edu, through Student Detail Schedule or Canvas at MyMtSAC Portal.

**Students must use their Mt.SAC e-mail account and be aware of course commitment and student expectations described at <http://www.mtsac.edu/distancelearning/>**

**To prepare for a successful online learning experience, see helpful short videos at <http://www.mtsac.edu/distancelearning/quiz/>**

■ **PHIL 9 — Critical Thinking and Writing** **3.0 Units**  
 Degree Applicable, CSU, UC

*Prerequisite: ENGL 1A or ENGL 1AH*

Function and use of formal and informal logic, argument, critical evaluation, and language in written composition.

10256 TWTh 7:30am - 10:20am Merward III, C 26A-1690  
**NOTE: No cost digital textbooks or textual materials used.**

10257 arrange 9 hours Stowell, A ONLINE  
**NOTE: CRN 10257 is a Distance Learning Online Class.**

**How to Begin Course:** Log into Canvas through the e-Learning Tools tab in the Mt.SAC portal at [inside.mtsac.edu](http://inside.mtsac.edu). Then click on the Canvas link and then click on the CRN to log into your DL course. **NOTE:** Some courses may not be activated until the start of the term. If you cannot locate your DL course in Canvas when the term starts, contact the professor. **On the first day of classes, log into your DL course to show your "attendance" because not doing so could result in your being dropped from the class for non-attendance.**

**Professor contact info:** Email Professor Stowell at either: AStowell@mtsac.edu, through Student Detail Schedule or Canvas at MyMtSAC Portal.

**Students must use their Mt.SAC e-mail account and be aware of course commitment and student expectations described at <http://www.mtsac.edu/distancelearning/>**

**To prepare for a successful online learning experience, see helpful short videos at <http://www.mtsac.edu/distancelearning/quiz/>**

10267 arrange 9 hours Stowell, A ONLINE  
**NOTE: CRN 10267 is a Distance Learning Online Class.**

**How to Begin Course:** Log into Canvas through the e-Learning Tools tab in the Mt.SAC portal at [inside.mtsac.edu](http://inside.mtsac.edu). Then click on the Canvas link and then click on the CRN to log into your DL course. **NOTE:** Some courses may not be activated until the start of the term. If you cannot locate your DL course in Canvas when the term starts, contact the professor. **On the first day of classes, log into your DL course to show your "attendance" because not doing so could result in your being dropped from the class for non-attendance.**

**Professor contact info:** Email Professor Stowell at either: AStowell@mtsac.edu, through Student Detail Schedule or Canvas at MyMtSAC Portal.

**Students must use their Mt.SAC e-mail account and be aware of course commitment and student expectations described at <http://www.mtsac.edu/distancelearning/>**

**To prepare for a successful online learning experience, see helpful short videos at <http://www.mtsac.edu/distancelearning/quiz/>**

■ **PHIL 12 — Introduction to Ethics** **3.0 Units**  
 (C-ID PHIL 120) Degree Applicable, CSU, UC

*Prerequisite: Eligibility for ENGL 1A*

Concepts of morality and values, representative ethical theories, and applications to moral problems.

10071 TWTh 10:30am - 1:20pm Tonini, G 26A-2690  
 10131 arrange 9 hours Diem, A ONLINE

**NOTE: CRN 10131 is a Distance Learning Online Class.**

**How to Begin Course:** Log into Canvas through the e-Learning Tools tab in the Mt.SAC portal at [inside.mtsac.edu](http://inside.mtsac.edu). Then click on the Canvas link and then click on the CRN to log into your DL course. **NOTE:** Some courses may not be activated until the start of the term. If you cannot locate your DL course in Canvas when the term starts, contact the professor. **On the first day of classes, log into your DL course to show your "attendance" because not doing so could result in your being dropped from the class for non-attendance.**

**Professor contact info:** Email Professor Diem at either: ADiem@mtsac.edu, through Student Detail Schedule or Canvas at MyMtSAC Portal.

**Students must use their Mt.SAC e-mail account and be aware of course commitment and student expectations described at <http://www.mtsac.edu/distancelearning/>**

**To prepare for a successful online learning experience, see helpful short videos at <http://www.mtsac.edu/distancelearning/quiz/>**

**No cost digital textbooks or textual materials used.**

10214 arrange 9 hours Wolde-Yohannes, S ONLINE  
**NOTE: CRN 10214 is a Distance Learning Online Class.**

**How to Begin Course:** Log into Canvas through the e-Learning Tools tab in the Mt.SAC portal at [inside.mtsac.edu](http://inside.mtsac.edu). Then click on the Canvas link and then click on the CRN to log into your DL course. **NOTE:** Some courses may not be activated until the start of the term. If you cannot locate your DL course in Canvas when the term starts, contact the professor. **On the first day of classes, log into your DL course to show your "attendance" because not doing so could result in your being dropped from the class for non-attendance.**

**Professor contact info:** Email Professor Wolde-Yohannes at either: SWoldeYohannes@mtsac.edu, through Student Detail Schedule or Canvas at MyMtSAC Portal.

**Students must use their Mt.SAC e-mail account and be aware of course commitment and student expectations described at <http://www.mtsac.edu/distancelearning/>**

**To prepare for a successful online learning experience, see helpful short videos at <http://www.mtsac.edu/distancelearning/quiz/>**

■ **PHIL 12H — Introduction to Ethics - Honors** 3.0 Units  
 (C-ID PHIL 120) Degree Applicable, CSU, UC

*Prerequisite: Acceptance into the Honors Program*

An honors course providing an enriched experience. May not receive credit for both PHIL 12 and PHIL 12H.

10770 TWTTh 1:30pm - 4:20pm Ramal, R 26D-2240

■ **PHIL 15 — Major World Religions** 3.0 Units  
 Degree Applicable, CSU, UC

*Prerequisite: Eligibility for ENGL 68*

History, doctrines, and practices of the major world religions. Off-campus assignments are required.

10200 TWTTh 10:30am - 1:20pm Ramal, R 26D-2230  
 10132 arrange 9 hours Diem, A ONLINE

**NOTE: CRN 10132 is a Distance Learning Online Class.**

**How to Begin Course:** Log into Canvas through the e-Learning Tools tab in the Mt.SAC portal at [inside.mtsac.edu](http://inside.mtsac.edu). Then click on the Canvas link and then click on the CRN to log into your DL course. **NOTE:** Some courses may not be activated until the start of the term. If you cannot locate your DL course in Canvas when the term starts, contact the professor. **On the first day of classes, log into your DL course to show your "attendance" because not doing so could result in your being dropped from the class for non-attendance.**

**Professor contact info:** Email Professor Diem at either: ADiem@mtsac.edu, through Student Detail Schedule or Canvas at MyMtSAC Portal.

**Students must use their Mt.SAC e-mail account and be aware of course commitment and student expectations described at <http://www.mtsac.edu/distancelearning/>**

**To prepare for a successful online learning experience, see helpful short videos at <http://www.mtsac.edu/distancelearning/quiz/>**

**No cost digital textbooks or textual materials used.**

10133 arrange 9 hours Diem, A ONLINE

**NOTE: CRN 10133 is a Distance Learning Online Class.**

**How to Begin Course:** Log into Canvas through the e-Learning Tools tab in the Mt.SAC portal at [inside.mtsac.edu](http://inside.mtsac.edu). Then click on the Canvas link and then click on the CRN to log into your DL course. **NOTE:** Some courses may not be activated until the start of the term. If you cannot locate your DL course in Canvas when the term starts, contact the professor. **On the first day of classes, log into your DL course to show your "attendance" because not doing so could result in your being dropped from the class for non-attendance.**

**Professor contact info:** Email Professor Diem at either: ADiem@mtsac.edu, through Student Detail Schedule or Canvas at MyMtSAC Portal.

**Students must use their Mt.SAC e-mail account and be aware of course commitment and student expectations described at <http://www.mtsac.edu/distancelearning/>**

**To prepare for a successful online learning experience, see helpful short videos at <http://www.mtsac.edu/distancelearning/quiz/>**

**No cost digital textbooks or textual materials used.**

## PHOTOGRAPHY

■ **PHOT 5 — Digital Cameras and Composition** 1.0 Unit  
 Degree Applicable

Use of digital cameras and image editing software. Camera required after first class meeting. Field trip required.

10639 F 6:00pm - 8:05pm Schaedel, J 13-1455  
 and S 9:00am - 4:50pm Schaedel, J 13-1455  
 and Su 9:00am - 4:50pm Schaedel, J 13-1455  
**1 Weeks, Week beginning 06/22/2018 ending 06/24/2018**

**NOTE:** CRN 10639: No-cost digital textbooks or textual materials used

■ **PHOT 9 — Digital Image Editing for Photographers** 3.0 Units  
 Degree Applicable

Image editing software and techniques commonly used in photography.

10636 MTWTh 12:00pm - 1:20pm Felix, L 13-2425  
 and MTWTh 1:30pm - 3:45pm Felix, L 13-2425

**NOTE:** CRN 10636: No-cost digital textbooks or textual materials used

■ **PHOT 10 — Basic Digital and Film Photography** 3.0 Units  
 Degree Applicable, CSU, UC

The basic mechanical, optical, and chemical properties of photography, including digital and traditional darkroom techniques.

10564 MTWTh 8:00am - 9:20am Benoe, C 13-1455  
 and MTWTh 9:30am - 11:45am Benoe, C 13-1455

**NOTE:** CRN 10564: No-cost digital textbooks or textual materials used

10634 MTWTh 12:00pm - 1:20pm Benoe, C 13-1455  
 and MTWTh 1:30pm - 3:45pm Benoe, C 13-1455

**NOTE:** CRN 10634: No-cost digital textbooks or textual materials used

10635 MTWTh 6:00pm - 7:20pm Clark, H 13-1455  
 and MTWTh 7:30pm - 9:45pm Clark, H 13-1455

**NOTE:** CRN 10635: No-cost digital textbooks or textual materials used

■ **PHOT 20 — Color Photography** 3.0 Units  
 Degree Applicable

*Prerequisite: PHOT 10*

Color principles as they relate to commercial and artistic styles of photography.

10637 MTWTh 8:00am - 9:20am Perez, J 13-1430  
 and MTWTh 9:30am - 11:45am Perez, J 13-1430

**NOTE:** CRN 10637: No-cost digital textbooks or textual materials used

■ **PHOT 21 — Exploring Color Photography** 3.0 Units  
 Degree Applicable

*Prerequisite: PHOT 20*

Use of color principles as they relate to commercial and artistic styles and innovative use of color applications.

10638 MTWTh 8:00am - 9:20am Perez, J 13-1430  
 and MTWTh 9:30am - 11:45am Perez, J 13-1430

**NOTE:** CRN 10638: No-cost digital textbooks or textual materials used

## PHYSICS

■ **PHYS 1 — Physics** 4.0 Units  
 Degree Applicable, CSU, UC

*Prerequisite: Eligibility for MATH 100*

Discovery of concepts in physics through guided activities in mechanics, electricity, magnetism, and geometrical optics.

10685 MTWTh 9:00am - 11:05am Anderson, D 60-1503  
 and MTWTh 11:30am - 1:35pm Anderson, D 60-1503

■ **PHYS 2AG — General Physics** **4.0 Units**  
(C-ID PHYS 105) Degree Applicable, CSU, UC

*Prerequisite:* MATH 150

Basic principles of physics. Mechanics, heat, fluids, and wave motion. Includes laboratory.

10686	MTWTh	7:30am - 9:35am	Tatoian, V	60-1620
and	MTWTh	10:00am - 12:05pm	Tatoian, V	60-1620
10687	MTWTh	8:00am - 10:05am	STAFF	60-1628
and	MTWTh	10:30am - 12:35pm	STAFF	60-1628
10688	MTWTh	12:30pm - 2:35pm	STAFF	60-1620
and	MTWTh	3:00pm - 5:05pm	STAFF	60-1620
10689	MTWTh	1:00pm - 3:05pm	STAFF	60-1628
and	MTWTh	3:30pm - 5:35pm	STAFF	60-1628

■ **PHYS 2BG — General Physics** **4.0 Units**  
(C-ID PHYS 110) Degree Applicable, CSU, UC

*Prerequisite:* PHYS 2AG or equivalent

Continuation of PHYS 2AG. Includes electricity and magnetism, optics, and modern physics. Includes laboratory.

10690	MTWTh	9:00am - 11:05am	Schnurbusch, K	11-2304
and	MTWTh	11:30am - 1:35pm	Schnurbusch, K	11-2304

■ **PHYS 99 — Special Projects in Physics** **2.0 Units**  
Degree Applicable, CSU

*Corequisite:* PHYS 1 or PHYS 2AG or PHYS 4A (May have been taken previously)

Instructor's authorization needed prior to enrollment. Field trips may be required as part of this course.

10691		6 hours	STAFF	
-------	--	---------	-------	--

**NOTE: Corequisite:** PHYS 1 or PHYS 2AG or PHYS 4A (May have been taken previously) In order to offer selected students recognition for their academic interests and ability, and the opportunity to explore their disciplines to greater depth, the various departments from time to time offer Special Projects courses. The content of each course and the methods of study vary from semester to semester and depend on the particular project under consideration. Student must have instructor's authorization before enrolling in this class. Field trips may be required as part of this course.

## POLITICAL SCIENCE

■ **POLI 1 — Introduction to American Government and Politics** **3.0 Units**

(C-ID POLS 110) Degree Applicable, CSU, UC

*Prerequisite:* Eligibility for ENGL 1A

Principles and problems of government with particular emphasis on the national government of the U.S.

10073	TWTh	7:30am - 10:20am	Stone, J	26D-G421
10250	TWTh	7:30am - 10:20am	Jollevet, F	26D-G210
10076	TWTh	10:30am - 1:20pm	Stone, J	26D-G421
10251	TWTh	10:30am - 1:20pm	Trull, S	26D-G210
10077	TWTh	1:30pm - 4:20pm	Stone, J	26D-G421
10254	TWTh	1:30pm - 4:20pm	Khalife, E	26D-G210
10590	TWTh	4:30pm - 7:20pm	Lawton, J	26D-G290
10241	TWTh	7:30pm - 10:20pm	Gonzalez, R	26D-G210

■ **POLI 25 — Latino Politics in the United States** **3.0 Units**  
Degree Applicable, CSU, UC

*Prerequisite:* Eligibility for ENGL 1A

Latino political thought and action and how it is influenced and shaped by American institutions.

10591	TWTh	7:30am - 10:20am	Ramos Bernal, N	26D-G290
10139	TWTh	10:30am - 1:20pm	Madrid, R	26D-G411
10210	TWTh	4:30pm - 7:20pm	Pringle, L	26D-G411

## PSYCHOLOGY

■ **PSYC 1A — Introduction to Psychology** **3.0 Units**  
(C-ID PSY 110) Degree Applicable, CSU, UC

*Prerequisite:* Eligibility for ENGL 1A

*Advisory:* Eligibility for READ 100 or completion of AMLA 33R

Psychological approaches to the study of behavior and mental processes.

10078	MTW	7:30am - 10:20am	Shaw, T	26A-2670
10147	MTW	10:30am - 1:20pm	Beakes, J	26A-2891
10181	TWTh	10:30am - 1:20pm	Chhun, S	26A-2670
10182	MTW	1:30pm - 4:20pm	Willis, J	26A-2670
10207	TWTh	1:30pm - 4:20pm	Alcala, M	26A-2891
10208	MTW	7:30pm - 10:20pm	Pace, M	26A-2670
10134		arrange 9 hours	Blacksher, S	ONLINE

**NOTE: CRN 10134 is a Distance Learning Online Class.**

**How to Begin Course:** Log into Canvas through the e-Learning Tools tab in the Mt.SAC portal at [inside.mtsac.edu](http://inside.mtsac.edu). Then click on the Canvas link and then click on the CRN to log into your DL course. **NOTE:** Some courses may not be activated until the start of the term. If you cannot locate your DL course in Canvas when the term starts, contact the professor. **On the first day of classes, log into your DL course to show your "attendance" because not doing so could result in your being dropped from the class for non-attendance.**

**Professor contact info:** Email Professor Blacksher at either: SBlacksher@mtsac.edu, through Student Detail Schedule or Canvas at MyMtSAC Portal.

**Students must use their Mt.SAC e-mail account and be aware of course commitment and student expectations described at <http://www.mtsac.edu/distancelearning/>**

**To prepare for a successful online learning experience, see helpful short videos at <http://www.mtsac.edu/distancelearning/quiz/>**

10135		arrange 9 hours	Ano, G	ONLINE
-------	--	-----------------	--------	--------

**NOTE: CRN 10135 is a Distance Learning Online Class.**

**How to Begin Course:** Log into Canvas through the e-Learning Tools tab in the Mt.SAC portal at [inside.mtsac.edu](http://inside.mtsac.edu). Then click on the Canvas link and then click on the CRN to log into your DL course. **NOTE:** Some courses may not be activated until the start of the term. If you cannot locate your DL course in Canvas when the term starts, contact the professor. **On the first day of classes, log into your DL course to show your "attendance" because not doing so could result in your being dropped from the class for non-attendance.**

**Professor contact info:** Email Professor Ano at either: GAno@mtsac.edu, through Student Detail Schedule or Canvas at MyMtSAC Portal.

**Students must use their Mt.SAC e-mail account and be aware of course commitment and student expectations described at <http://www.mtsac.edu/distancelearning/>**

**To prepare for a successful online learning experience, see helpful short videos at <http://www.mtsac.edu/distancelearning/quiz/>**

10136		arrange 9 hours	Kolchakian, M	ONLINE
-------	--	-----------------	---------------	--------

**NOTE: CRN 10136 is a Distance Learning Online Class.**

**How to Begin Course:** Log into Canvas through the e-Learning Tools tab in the Mt.SAC portal at [inside.mtsac.edu](http://inside.mtsac.edu). Then click on the Canvas link and then click on the CRN to log into your DL course. **NOTE:** Some courses may not be activated until the start of the term. If you cannot locate your DL course in Canvas when the term starts, contact the professor. **On the first day of classes, log into your DL course to show your "attendance" because not doing so could result in your being dropped from the class for non-attendance.**

**Professor contact info:** Email Professor Kolchakian at either: MKolchakian@mtsac.edu, through Student Detail Schedule or Canvas at MyMtSAC Portal.

**Students must use their Mt.SAC e-mail account and be aware of course commitment and student expectations described at <http://www.mtsac.edu/distancelearning/>**

**To prepare for a successful online learning experience, see helpful short videos at <http://www.mtsac.edu/distancelearning/quiz/>**

10158 arrange 9 hours Kolchakian, M ONLINE  
**NOTE: CRN 10158 is a Distance Learning Online Class.**

**How to Begin Course:** Log into Canvas through the e-Learning Tools tab in the Mt.SAC portal at [inside.mtsac.edu](http://inside.mtsac.edu). Then click on the Canvas link and then click on the CRN to log into your DL course. **NOTE:** Some courses may not be activated until the start of the term. If you cannot locate your DL course in Canvas when the term starts, contact the professor. **On the first day of classes, log into your DL course to show your "attendance" because not doing so could result in your being dropped from the class for non-attendance.**

**Professor contact info:** Email Professor Kolchakian at either: MKolchakian@mtsac.edu, through Student Detail Schedule or Canvas at MyMtSAC Portal.

**Students must use their Mt.SAC e-mail account and be aware of course commitment and student expectations described at <http://www.mtsac.edu/distancelearning/>**

**To prepare for a successful online learning experience, see helpful short videos at <http://www.mtsac.edu/distancelearning/quiz/>**

10224 arrange 9 hours Dowdle, M ONLINE  
**NOTE: CRN 10224 is a Distance Learning Online Class.**

**How to Begin Course:** Log into Canvas through the e-Learning Tools tab in the Mt.SAC portal at [inside.mtsac.edu](http://inside.mtsac.edu). Then click on the Canvas link and then click on the CRN to log into your DL course. **NOTE:** Some courses may not be activated until the start of the term. If you cannot locate your DL course in Canvas when the term starts, contact the professor. **On the first day of classes, log into your DL course to show your "attendance" because not doing so could result in your being dropped from the class for non-attendance.**

**Professor contact info:** Email Professor Dowdle at either: MDowdle@mtsac.edu, through Student Detail Schedule or Canvas at MyMtSAC Portal.

**Students must use their Mt.SAC e-mail account and be aware of course commitment and student expectations described at <http://www.mtsac.edu/distancelearning/>**

**To prepare for a successful online learning experience, see helpful short videos at <http://www.mtsac.edu/distancelearning/quiz/>**

10593 arrange 9 hours Knapp, J ONLINE  
**NOTE: CRN 10593 is a Distance Learning Online Class.**

**How to Begin Course:** Log into Canvas through the e-Learning Tools tab in the Mt.SAC portal at [inside.mtsac.edu](http://inside.mtsac.edu). Then click on the Canvas link and then click on the CRN to log into your DL course. **NOTE:** Some courses may not be activated until the start of the term. If you cannot locate your DL course in Canvas when the term starts, contact the professor. **On the first day of classes, log into your DL course to show your "attendance" because not doing so could result in your being dropped from the class for non-attendance.**

**Professor contact info:** Email Professor Knapp at either: JKnapp@mtsac.edu, through Student Detail Schedule or Canvas at MyMtSAC Portal.

**Students must use their Mt.SAC e-mail account and be aware of course commitment and student expectations described at <http://www.mtsac.edu/distancelearning/>**

**To prepare for a successful online learning experience, see helpful short videos at <http://www.mtsac.edu/distancelearning/quiz/>**

■ **PSYC 1AH — Introduction to Psychology - Honors** 3.0 Units  
 (C-ID PSY 110) Degree Applicable, CSU, UC

*Prerequisite: Acceptance into the Honors Program*

*Advisory: Eligibility for READ 100 or completion of AMLA 33R*

Honors course in behavior and mental processes. May not receive credit for both PSYC 1A and PSYC 1AH.

10229 MTW 7:30am - 10:20am Powell, C 26A-2831

■ **PSYC 1B — Biological Psychology** 3.0 Units  
 (C-ID PSY 150) Degree Applicable, CSU, UC

*Prerequisite: PSYC 1A or PSYC 1AH*

*Advisory: Eligibility for ENGL 1A*

Biological mechanisms of behavior. Includes evolution and genetics with emphasis on neuronal and synaptic transmission.

10222 TWTh 7:30am - 10:20am Lucas, H 18D-1105

10079 TWTh 10:30am - 1:20pm Keo-Trang, Z 26A-2821

■ **PSYC 14 — Developmental Psychology** 3.0 Units  
 (C-ID PSY 180) Degree Applicable, CSU, UC

*Advisory: Eligibility for ENGL 1A*

Psychological principles across the lifespan. This course does not fulfill Title 22 requirements for Child Development majors.

10080 MTW 7:30am - 10:20am Laub, K 26A-2620

10226 TWTh 7:30am - 10:20am Sabet, S 26A-2821

10201 MTW 10:30am - 1:20pm Ingersoll, B 26A-2811

10594 TWTh 10:30am - 1:20pm Thomas, B 40-133

10278 arrange 9 hours Bacigalupi, S ONLINE

**NOTE: CRN 10278 is a Distance Learning Online Class.**

**How to Begin Course:** Log into Canvas through the e-Learning Tools tab in the Mt.SAC portal at [inside.mtsac.edu](http://inside.mtsac.edu). Then click on the Canvas link and then click on the CRN to log into your DL course. **NOTE:** Some courses may not be activated until the start of the term. If you cannot locate your DL course in Canvas when the term starts, contact the professor. **On the first day of classes, log into your DL course to show your "attendance" because not doing so could result in your being dropped from the class for non-attendance.**

**Professor contact info:** Email Professor Bacigalupi at either: SBacigalupi@mtsac.edu, through Student Detail Schedule or Canvas at MyMtSAC Portal.

**Students must use their Mt.SAC e-mail account and be aware of course commitment and student expectations described at <http://www.mtsac.edu/distancelearning/>**

**To prepare for a successful online learning experience, see helpful short videos at <http://www.mtsac.edu/distancelearning/quiz/>**

10595 arrange 9 hours Powell, C ONLINE

**NOTE: CRN 10595 is a Distance Learning Online Class.**

**How to Begin Course:** Log into Canvas through the e-Learning Tools tab in the Mt.SAC portal at [inside.mtsac.edu](http://inside.mtsac.edu). Then click on the Canvas link and then click on the CRN to log into your DL course. **NOTE:** Some courses may not be activated until the start of the term. If you cannot locate your DL course in Canvas when the term starts, contact the professor. **On the first day of classes, log into your DL course to show your "attendance" because not doing so could result in your being dropped from the class for non-attendance.**

**Professor contact info:** Email Professor Powell at either: CPowell@mtsac.edu, through Student Detail Schedule or Canvas at MyMtSAC Portal.

**Students must use their Mt.SAC e-mail account and be aware of course commitment and student expectations described at <http://www.mtsac.edu/distancelearning/>**

**To prepare for a successful online learning experience, see helpful short videos at <http://www.mtsac.edu/distancelearning/quiz/>**

10596 arrange 9 hours Blacksher, S ONLINE

**NOTE: CRN 10596 is a Distance Learning Online Class.**

**How to Begin Course:** Log into Canvas through the e-Learning Tools tab in the Mt.SAC portal at [inside.mtsac.edu](http://inside.mtsac.edu). Then click on the Canvas link and then click on the CRN to log into your DL course. **NOTE:** Some courses may not be activated until the start of the term. If you cannot locate your DL course in Canvas when the term starts, contact the professor. **On the first day of classes, log into your DL course to show your "attendance" because not doing so could result in your being dropped from the class for non-attendance.**

**Professor contact info:** Email Professor Blacksher at either: SBlacksher@mtsac.edu, through Student Detail Schedule or Canvas at MyMtSAC Portal.

**Students must use their Mt.SAC e-mail account and be aware of course commitment and student expectations described at <http://www.mtsac.edu/distancelearning/>**

**To prepare for a successful online learning experience, see helpful short videos at <http://www.mtsac.edu/distancelearning/quiz/>**

■ **PSYC 19 — Abnormal Psychology** **3.0 Units**  
(C-ID PSY 120) Degree Applicable, CSU, UC

*Prerequisite: PSYC 1A or PSYC 1AH*

Students will be familiarized with psychological, biological, and sociocultural approaches to understanding abnormal behavior.

10230 TWTTh 10:30am - 1:20pm Nolan Marion, M 26A-2620  
10244 arrange 9 hours Knapp, J ONLINE

**NOTE: CRN 10244 is a Distance Learning Online Class.**

**How to Begin Course:** Log into Canvas through the e-Learning Tools tab in the Mt.SAC portal at [inside.mtsac.edu](http://inside.mtsac.edu). Then click on the Canvas link and then click on the CRN to log into your DL course. **NOTE:** Some courses may not be activated until the start of the term. If you cannot locate your DL course in Canvas when the term starts, contact the professor. **On the first day of classes, log into your DL course to show your "attendance" because not doing so could result in your being dropped from the class for non-attendance.**

**Professor contact info:** Email Professor Knapp at either: JKnapp@mtsac.edu, through Student Detail Schedule or Canvas at MyMtSAC Portal.

**Students must use their Mt.SAC e-mail account and be aware of course commitment and student expectations described at <http://www.mtsac.edu/distancelearning/>**

**To prepare for a successful online learning experience, see helpful short videos at <http://www.mtsac.edu/distancelearning/quiz/>**

10769 arrange 9 hours Louie, C ONLINE

**NOTE: CRN 10769 is a Distance Learning Online Class.**

**How to Begin Course:** Log into Canvas through the e-Learning Tools tab in the Mt.SAC portal at [inside.mtsac.edu](http://inside.mtsac.edu). Then click on the Canvas link and then click on the CRN to log into your DL course. **NOTE:** Some courses may not be activated until the start of the term. If you cannot locate your DL course in Canvas when the term starts, contact the professor. **On the first day of classes, log into your DL course to show your "attendance" because not doing so could result in your being dropped from the class for non-attendance.**

**Professor contact info:** Email Professor Louie at either: CLouie@mtsac.edu, through Student Detail Schedule or Canvas at MyMtSAC Portal.

**Students must use their Mt.SAC e-mail account and be aware of course commitment and student expectations described at <http://www.mtsac.edu/distancelearning/>**

**To prepare for a successful online learning experience, see helpful short videos at <http://www.mtsac.edu/distancelearning/quiz/>**

■ **PSYC 25 — The Psychology of Women** **3.0 Units**  
Degree Applicable, CSU, UC

*Advisory: PSYC 1A (taken prior or concurrently), and ENGL 1A (taken prior or concurrently)*

A biopsychosocial analysis of the role of gender in the experience of women.

10223 TWTTh 7:30am - 10:20am Klee, G 26A-2811

■ **PSYC 26 — Psychology of Sexuality** **3.0 Units**  
(C-ID PSY 130) Degree Applicable, CSU, UC

*Prerequisite: Eligibility for ENGL 68*

Explores the factors involved in establishing and maintaining intimate sexual relationships.

10209 MTW 10:30am - 1:20pm Joneja, K 18D-1105

## PUBLIC HEALTH

■ **PUBH 24 — Introduction to Public Health** **3.0 Units**  
Degree Applicable, CSU, UC

*Prerequisite: Eligibility for ENGL 1A*

Organization and function of public health including current and ethical issues.

10526 arrange 9 hours Rexach, C ONLINE

**NOTE: CRN 10526 is a Distance Learning Online class.**

**How to Begin Course:** Log into Canvas through <http://myportal.mtsac.edu> and click on CRN for your DL course. **NOTE:** Some courses may not be activated until the start of the term. If you cannot locate your DL course in Canvas when the term starts, contact the professor. **On the first day of classes, log into your DL course to show your attendance because not doing so could result in your being dropped from the class for non-attendance.**

**Professor contact info:** Email Professor Rexach at either: Crxach@mtsac.edu, through Student Detail Schedule or Canvas at MyMtSAC Portal.

**Students must use their Mt. SAC e-mail account and be aware of course commitment and student expectations described at <http://www.mtsac.edu/instruction/learning/distlearn/>**

**To prepare for a successful online learning experience, see helpful short videos at <http://www.mtsac.edu/distancelearning/quiz/>**

■ **PUBH 26 — Introduction to Global Public Health** **3.0 Units**  
Degree Applicable, CSU

*Prerequisite: (PUBH 24 or BIOL 24) and (MATH 110 or MATH 110H or PSYC 10)*

*Advisory: Eligibility for READ 100 or AMLA 33R*

Health and disease in terms of global processes and socioeconomic influences. Major communicable and noncommunicable diseases.

10556 arrange 9 hours Rexach, C ONLINE

## RADIO - TELEVISION

■ **R-TV 01 — Introduction to Electronic Media** **3.0 Units**  
Degree Applicable, CSU

*Prerequisite: Eligibility for ENGL 68*

History, structure, function, economics, content and evolution of radio, television, film, the Internet, and new media.

10570 MTW 1:30pm - 4:20pm Smith, D 26A-2831

■ **R-TV 06 — Broadcast Traffic Reporting** **1.5 Units**  
Degree Applicable

*Corequisite: R-TV 01 (May have been taken previously)*

Preparation and delivery of traffic reports for radio and television, including anchored and airborne reports.

10629 MTW 8:45am - 10:10am Trujillo, T 13-2430

■ **R-TV 22 — Editing for Film and Television** **3.0 Units**  
Degree Applicable, CSU

Aesthetics and use of editing software for film and TV. Previous production experience recommended.

10571 MTW 10:30am - 1:20pm Kelly, S 13-1420

■ **R-TV 31 — History of Radio DJs** **3.0 Units**  
Degree Applicable

Traces the history of music radio through study of the most influential disc jockeys in broadcasting history.

10630 MTW 10:30am - 1:20pm Trujillo, T 13-2430



**R-TV 100 — Work Experience in Film and TV** **1.0 Unit**

Degree Applicable

(May be taken for option of Letter grade or Pass/NoPass)  
*Prerequisite:* Completion of 12 units of R-TV courses, from among the following: R-TV 18, R-TV 19A, R-TV 19B, R-TV 20, R-TV 21, R-TV 22, R-TV 23, and R-TV 29. Compliance with Work Experience regulations as designated in the College Catalog.

On-the-job experience in the film and television industry. 60 unpaid or 75 paid hours per unit of credit.

10589	12.5 hours	Smith, D	13-1477
10626	12.5 hours	Kelly, S	13-1471

**R-TV 100 — Work Experience in Film and TV** **2.0 Units**

Degree Applicable

(May be taken for option of Letter grade or Pass/NoPass)  
*Prerequisite:* Completion of 12 units of R-TV courses, from among the following: R-TV 18, R-TV 19A, R-TV 19B, R-TV 20, R-TV 21, R-TV 22, R-TV 23, and R-TV 29. Compliance with Work Experience regulations as designated in the College Catalog.

On-the-job experience in the film and television industry. 60 unpaid or 75 paid hours per unit of credit.

10625	25 hours	Smith, D	13-1477
10627	25 hours	Kelly, S	13-1471

**RADIOLOGIC TECHNOLOGY**

**RAD 2B — Clinical Experience 2B** **3.0 Units**

Degree Applicable, CSU

(May be taken for Pass/No Pass Only)

*Prerequisite:* RAD 2A

Clinical experience in radiology department under the supervision of a licensed radiologic technologist.

10024	arrange	24 hours	Neel, M	HOSP
-------	---------	----------	---------	------

**RAD 4 — Clinical Experience 4** **4.5 Units**

Degree Applicable, CSU

(May be taken for Pass/No Pass Only)

*Prerequisite:* RAD 3C

Clinical experience in radiology department under the supervision of a licensed radiologic technologist.

10025	MTWThF	8:00am - 12:05pm	McLaughlin, D	HOSP
	and MTWThF	12:40pm - 4:30pm	McLaughlin, D	HOSP

**RAD 50 — Introduction to Radiologic Science and Health Care** **3.0 Units**

Degree Applicable, CSU

Foundations of radiography, practitioner's role in healthcare delivery system, radiation protection, ethics and law.

10012	TTh	9:30am - 1:45pm	Engisch, P	67A-123
-------	-----	-----------------	------------	---------

**RAD 91 — Patient Care in Radiologic Sciences** **3.0 Units**

Degree Applicable, CSU

Concepts of optimal patient care, pharmacology, and role of the radiographer in patient education.

10013	MW	7:00am - 10:30am	Toy-Ortega, K	67A-123
	and MW	10:40am - 12:45pm	Toy-Ortega, K	67A-123

**READING**

**READING COURSE SEQUENCE:  
PATHWAYS TO READING COMPETENCY  
FOR AA/AS DEGREE**

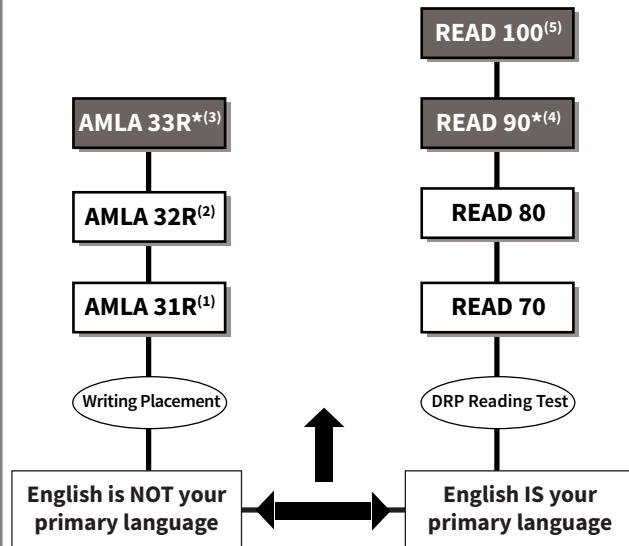

**COURSE NOTES:**

\* "C" or better meets graduation competency

- 1 - Eligibility for AMLA 41W
- 2 - Eligibility for AMLA 42W
- 3 - Eligibility for AMLA 43W
- 4 - Grade of "C" or better in READ 90 meets AA/AS degree competency
- 5 - Eligibility for READ 100 meets AA/AS degree competency and is CSU transferable

*Why take a READING CLASS early on?*

- Improves comprehension
- Supports reading across disciplines (STEM & non-STEM)
- Enhances critical thinking
- Expands vocabulary
- Promotes interaction with text

**READ 80 — Exploring Reading Strategies** **3.0 Units**

Not Degree Applicable

(May be taken for Pass/No Pass Only)

*Prerequisite:* READ 70 or satisfactory score on reading placement test

Reading comprehension, vocabulary strategies, and self-awareness of reading capabilities using narrative and expository text.

10368	MTWTh	10:15am - 12:20pm	Ezell, S	6-136
-------	-------	-------------------	----------	-------

■ **READ 90 — Reading College Texts** **3.0 Units**  
Degree Applicable

(May be taken for option of Letter grade or Pass/NoPass)

*Prerequisite:* READ 80 or satisfactory score on reading placement test

Effective college textbook reading with an emphasis on vocabulary and cross disciplinary textbook analysis and comprehension.

10369	MTWTh	8:00am - 10:05am	Ezell, S	6-130
10370	MTWTh	10:15am - 12:20pm	Cevallos, S	6-131
10371	MTW	4:30pm - 7:20pm	Burman, E	6-131
10372	MTW	4:30pm - 7:20pm	Wheeler, D	6-132
10373	MTW	7:30pm - 10:20pm	Wheeler, D	6-131
10396	arrange	9 hours	Cevallos, S	ONLINE

**NOTE: No cost digital textbooks or textual materials used.**

**CRN 10396** is a Distance Learning Online Class.

**How to Begin Course:** Log into Canvas through the e-Learning Tools tab in the Mt.SAC portal at [inside.mtsac.edu](http://inside.mtsac.edu). Then click on the Canvas link and then click on CRN for your DL course. **NOTE:** Some courses may not be activated until the start of the term. If you cannot locate your DL course in Canvas when the term starts, contact the professor. **On the first day of classes, log into your DL course to show your "attendance" because not doing so could result in your being dropped from the class for non-attendance.**

**Professor contact info:** Email Professor Cevallos at either: SCevallos2@mtsac.edu, through Student Detail Schedule or Canvas at MyMt-SAC Portal.

**Students must use their Mt.SAC e-mail account and be aware of course commitment and student expectations described at <http://www.mtsac.edu/distancelearning/>**

**To prepare for a successful online learning experience, see helpful short videos at <http://www.mtsac.edu/distancelearning/quiz/>**

■ **READ 100 — Analysis and Critical Reading** **3.0 Units**  
Degree Applicable, CSU

*Prerequisite:* READ 90 or satisfactory score on reading placement test

Critical reading course focusing on the effective use of critical thinking in a cross-disciplinary framework.

10391	MTWTh	8:00am - 10:05am	Cevallos, S	6-132
10392	MTW	1:30pm - 4:20pm	Silva, L	6-131
10395	arrange	9 hours	Silva, L	ONLINE

**NOTE: CRN 10395** is a Distance Learning Online Class.

**How to Begin Course:** Log into Canvas through the e-Learning Tools tab in the Mt.SAC portal at [inside.mtsac.edu](http://inside.mtsac.edu). Then click on the Canvas link and then click on CRN for your DL course. **NOTE:** Some courses may not be activated until the start of the term. If you cannot locate your DL course in Canvas when the term starts, contact the professor. **On the first day of classes, log into your DL course to show your "attendance" because not doing so could result in your being dropped from the class for non-attendance.**

**Professor contact info:** Email Professor Silva at either: LSilva@mtsac.edu, through Student Detail Schedule or Canvas at MyMtSAC Portal.

**Students must use their Mt.SAC e-mail account and be aware of course commitment and student expectations described at <http://www.mtsac.edu/distancelearning/>**

**To prepare for a successful online learning experience, see helpful short videos at <http://www.mtsac.edu/distancelearning/quiz/>**

## RESPIRATORY THERAPY

■ **RESD 56A — Techniques of Respiratory Therapy** **2.5 Units**  
Degree Applicable, CSU

(May be taken for Pass/No Pass Only)

*Prerequisite:* RESD 51B

*Corequisite:* RESD 57B

Clinical practice in intensive care and mechanical ventilator procedures in the treatment of adult and pediatric patients.

10014	arrange	23.83 hours	Hutchinson, J	HOSP
10015	arrange	23.83 hours	Hutchinson, J	HOSP
10016	arrange	23.83 hours	Hutchinson, J	HOSP

■ **RESD 57B — Special Procedures for Respiratory Care** **1.5 Units**  
Degree Applicable, CSU

*Prerequisite:* RESD 51B

*Corequisite:* RESD 56A

Application and skills development in pharmacology, bronchoscopy, mechanical ventilation, and arterial blood gas punctures.

10017	M	12:00pm - 4:15pm	Wiesner, M	67A-138
-------	---	------------------	------------	---------

## SIGN LANGUAGE, INTERPRETING

■ **SIGN 101 — American Sign Language 1** **4.0 Units**  
Degree Applicable, CSU, UC

Fundamentals of American Sign Language including work on comprehension skills and modeling grammatical structures.

10081	MTWTh	7:30am - 10:20am	STAFF	66-201
10149	MTWTh	10:30am - 1:20pm	Stuard, B	66-201
10592	MTWTh	10:30am - 1:20pm	Larson, S	66-205
10159	MTWTh	1:30pm - 4:20pm	Larson, S	66-201
10227	MTWTh	7:30pm - 10:20pm	Stuard, E	66-201

■ **SIGN 102 — American Sign Language 2** **4.0 Units**  
Degree Applicable, CSU, UC

*Prerequisite:* SIGN 101 or SIGN 101H

Further study of ASL as well as exposure to Deaf culture. Outside events attendance required.

10082	MTWTh	10:30am - 1:20pm	Dorough, G	21J-2
-------	-------	------------------	------------	-------

## SOCIOLOGY

■ **SOC 1 — Introduction to Sociology** **3.0 Units**  
(C-ID SOCI 110) Degree Applicable, CSU, UC

*Prerequisite:* Eligibility for ENGL 68

Systematic study of human relations and social structures emphasizing the interaction between personality, culture and society.

10083	TWTh	7:30am - 10:20am	Moss, J	26A-2871
-------	------	------------------	---------	----------

**NOTE: No cost digital textbooks or textual materials used.**

10084	TWTh	7:30am - 10:20am	VanderVis, M	26A-2690
-------	------	------------------	--------------	----------

**NOTE: No cost digital textbooks or textual materials used.**

10154	TWTh	10:30am - 1:20pm	Banuelos, M	26D-2431
-------	------	------------------	-------------	----------

**NOTE: No cost digital textbooks or textual materials used.**

10155	TWTh	7:30pm - 10:20pm	Dang, T	26D-2491
-------	------	------------------	---------	----------

**NOTE: No cost digital textbooks or textual materials used.**

10137	arrange	9 hours	Gallarde, M	ONLINE
-------	---------	---------	-------------	--------

**NOTE: CRN 10137** is a Distance Learning Online Class.

**How to Begin Course:** Log into Canvas through the e-Learning Tools tab in the Mt.SAC portal at [inside.mtsac.edu](http://inside.mtsac.edu). Then click on the Canvas link and then click on the CRN to log into your DL course. **NOTE:** Some courses may not be activated until the start of the term. If you cannot locate your DL course in Canvas when the term starts, contact the professor. **On the first day of classes, log into your DL course to show your "attendance" because not doing so could result in your being dropped from the class for non-attendance.**

**Professor contact info:** Email Professor Gallarde at either: MGallarde@mtsac.edu, through Student Detail Schedule or Canvas at MyMt-SAC Portal.

**Students must use their Mt.SAC e-mail account and be aware of course commitment and student expectations described at <http://www.mtsac.edu/distancelearning/>**

**To prepare for a successful online learning experience, see helpful short videos at <http://www.mtsac.edu/distancelearning/quiz/>**

**No cost digital textbooks or textual materials used.**

10138 arrange 9 hours Gallarde, M ONLINE  
**NOTE: CRN 10138 is a Distance Learning Online Class.**

**How to Begin Course:** Log into Canvas through the e-Learning Tools tab in the Mt.SAC portal at [inside.mtsac.edu](http://inside.mtsac.edu). Then click on the Canvas link and then click on the CRN to log into your DL course. **NOTE:** Some courses may not be activated until the start of the term. If you cannot locate your DL course in Canvas when the term starts, contact the professor. **On the first day of classes, log into your DL course to show your "attendance" because not doing so could result in your being dropped from the class for non-attendance.**

**Professor contact info:** Email Professor Gallarde at either: MGallarde@mtsac.edu, through Student Detail Schedule or Canvas at MyMtSAC Portal.

**Students must use their Mt.SAC e-mail account and be aware of course commitment and student expectations described at <http://www.mtsac.edu/distancelearning/>**

**To prepare for a successful online learning experience, see helpful short videos at <http://www.mtsac.edu/distancelearning/quiz/>**

**No cost digital textbooks or textual materials used.**

10258 arrange 9 hours Montero, S ONLINE  
**NOTE: CRN 10258 is a Distance Learning Online Class.**

**How to Begin Course:** Log into Canvas through the e-Learning Tools tab in the Mt.SAC portal at [inside.mtsac.edu](http://inside.mtsac.edu). Then click on the Canvas link and then click on the CRN to log into your DL course. **NOTE:** Some courses may not be activated until the start of the term. If you cannot locate your DL course in Canvas when the term starts, contact the professor. **On the first day of classes, log into your DL course to show your "attendance" because not doing so could result in your being dropped from the class for non-attendance.**

**Professor contact info:** Email Professor Montero at either: SMontero@mtsac.edu, through Student Detail Schedule or Canvas at MyMtSAC Portal.

**Students must use their Mt.SAC e-mail account and be aware of course commitment and student expectations described at <http://www.mtsac.edu/distancelearning/>**

**To prepare for a successful online learning experience, see helpful short videos at <http://www.mtsac.edu/distancelearning/quiz/>**

10268 arrange 9 hours Hernandez-Magallon, K ONLINE  
**NOTE: CRN 10268 is a Distance Learning Online Class.**

**How to Begin Course:** Log into Canvas through the e-Learning Tools tab in the Mt.SAC portal at [inside.mtsac.edu](http://inside.mtsac.edu). Then click on the Canvas link and then click on the CRN to log into your DL course. **NOTE:** Some courses may not be activated until the start of the term. If you cannot locate your DL course in Canvas when the term starts, contact the professor. **On the first day of classes, log into your DL course to show your "attendance" because not doing so could result in your being dropped from the class for non-attendance.**

**Professor contact info:** Email Professor Hernandez-Magallon at either: KHernandezMagallon@mtsac.edu, through Student Detail Schedule or Canvas at MyMtSAC Portal.

**Students must use their Mt.SAC e-mail account and be aware of course commitment and student expectations described at <http://www.mtsac.edu/distancelearning/>**

**To prepare for a successful online learning experience, see helpful short videos at <http://www.mtsac.edu/distancelearning/quiz/>**

**No cost digital textbooks or textual materials used.**

10269 arrange 9 hours Gallarde, M ONLINE  
**NOTE: CRN 10269 is a Distance Learning Online Class.**

**How to Begin Course:** Log into Canvas through the e-Learning Tools tab in the Mt.SAC portal at [inside.mtsac.edu](http://inside.mtsac.edu). Then click on the Canvas link and then click on the CRN to log into your DL course. **NOTE:** Some courses may not be activated until the start of the term. If you cannot locate your DL course in Canvas when the term starts, contact the professor. **On the first day of classes, log into your DL course to show your "attendance" because not doing so could result in your being dropped from the class for non-attendance.**

**Professor contact info:** Email Professor Gallarde at either: MGallarde@mtsac.edu, through Student Detail Schedule or Canvas at MyMtSAC Portal.

**Students must use their Mt.SAC e-mail account and be aware of course commitment and student expectations described at <http://www.mtsac.edu/distancelearning/>**

**To prepare for a successful online learning experience, see helpful short videos at <http://www.mtsac.edu/distancelearning/quiz/>**

**No cost digital textbooks or textual materials used.**

■ **SOC 2 — Contemporary Social Problems** 3.0 Units  
 (C-ID SOCI 115) Degree Applicable, CSU, UC

*Prerequisite: Eligibility for ENGL 68*

Basic sociological principles and concepts to the study and understanding of social problems.

10085 TWTh 10:30am - 1:20pm Mendoza Ramos, S 26D-2491  
 10252 arrange 9 hours Yoshioka, G ONLINE

**NOTE: CRN 10252 is a Distance Learning Online Class.**

**How to Begin Course:** Log into Canvas through the e-Learning Tools tab in the Mt.SAC portal at [inside.mtsac.edu](http://inside.mtsac.edu). Then click on the Canvas link and then click on the CRN to log into your DL course. **NOTE:** Some courses may not be activated until the start of the term. If you cannot locate your DL course in Canvas when the term starts, contact the professor. **On the first day of classes, log into your DL course to show your "attendance" because not doing so could result in your being dropped from the class for non-attendance.**

**Professor contact info:** Email Professor Yoshioka at either: GYoshioka@mtsac.edu, through Student Detail Schedule or Canvas at MyMtSAC Portal.

**Students must use their Mt.SAC e-mail account and be aware of course commitment and student expectations described at <http://www.mtsac.edu/distancelearning/>**

**To prepare for a successful online learning experience, see helpful short videos at <http://www.mtsac.edu/distancelearning/quiz/>**

10266 arrange 9 hours Yoshioka, G ONLINE  
**NOTE: CRN 10266 is a Distance Learning Online Class.**

**How to Begin Course:** Log into Canvas through the e-Learning Tools tab in the Mt.SAC portal at [inside.mtsac.edu](http://inside.mtsac.edu). Then click on the Canvas link and then click on the CRN to log into your DL course. **NOTE:** Some courses may not be activated until the start of the term. If you cannot locate your DL course in Canvas when the term starts, contact the professor. **On the first day of classes, log into your DL course to show your "attendance" because not doing so could result in your being dropped from the class for non-attendance.**

**Professor contact info:** Email Professor Yoshioka at either: GYoshioka@mtsac.edu, through Student Detail Schedule or Canvas at MyMtSAC Portal.

**Students must use their Mt.SAC e-mail account and be aware of course commitment and student expectations described at <http://www.mtsac.edu/distancelearning/>**

**To prepare for a successful online learning experience, see helpful short videos at <http://www.mtsac.edu/distancelearning/quiz/>**

■ **SOC 5 — Introduction to Criminology** **3.0 Units**  
(C-ID SOCI 160) Degree Applicable, CSU, UC

*Prerequisite:* Eligibility for ENGL 68

A scientific analysis of violations of societal rules of behavior that are formally defined as crime and delinquency.

10086 TWTTh 10:30am - 1:20pm Lukenbill, C 26D-2240  
10193 arrange 9 hours Howey, D ONLINE

**NOTE:** CRN 10193 is a Distance Learning Online Class.

**How to Begin Course:** Log into Canvas through the e-Learning Tools tab in the Mt.SAC portal at inside.mtsac.edu. Then click on the Canvas link and then click on the CRN to log into your DL course. **NOTE:** Some courses may not be activated until the start of the term. If you cannot locate your DL course in Canvas when the term starts, contact the professor. **On the first day of classes, log into your DL course to show your "attendance" because not doing so could result in your being dropped from the class for non-attendance.**

**Professor contact info:** Email Professor Howey at either: DHowey@mtsac.edu, through Student Detail Schedule or Canvas at MyMtSAC Portal.

**Students must use their Mt.SAC e-mail account and be aware of course commitment and student expectations described at <http://www.mtsac.edu/distancelearning/>**

**To prepare for a successful online learning experience, see helpful short videos at <http://www.mtsac.edu/distancelearning/quiz/>**

10215 arrange 9 hours Lawson, K ONLINE

**NOTE:** CRN 10215 is a Distance Learning Online Class.

**How to Begin Course:** Log into Canvas through the e-Learning Tools tab in the Mt.SAC portal at inside.mtsac.edu. Then click on the Canvas link and then click on the CRN to log into your DL course. **NOTE:** Some courses may not be activated until the start of the term. If you cannot locate your DL course in Canvas when the term starts, contact the professor. **On the first day of classes, log into your DL course to show your "attendance" because not doing so could result in your being dropped from the class for non-attendance.**

**Professor contact info:** Email Professor Lawson at either: KLawson@mtsac.edu, through Student Detail Schedule or Canvas at MyMtSAC Portal.

**Students must use their Mt.SAC e-mail account and be aware of course commitment and student expectations described at <http://www.mtsac.edu/distancelearning/>**

**To prepare for a successful online learning experience, see helpful short videos at <http://www.mtsac.edu/distancelearning/quiz/>**

10259 arrange 9 hours Tolmasov, B ONLINE

**NOTE:** CRN 10259 is a Distance Learning Online Class.

**How to Begin Course:** Log into Canvas through the e-Learning Tools tab in the Mt.SAC portal at inside.mtsac.edu. Then click on the Canvas link and then click on the CRN to log into your DL course. **NOTE:** Some courses may not be activated until the start of the term. If you cannot locate your DL course in Canvas when the term starts, contact the professor. **On the first day of classes, log into your DL course to show your "attendance" because not doing so could result in your being dropped from the class for non-attendance.**

**Professor contact info:** Email Professor Tolmasov at either: BTolmasov@mtsac.edu, through Student Detail Schedule or Canvas at MyMtSAC Portal.

**Students must use their Mt.SAC e-mail account and be aware of course commitment and student expectations described at <http://www.mtsac.edu/distancelearning/>**

**To prepare for a successful online learning experience, see helpful short videos at <http://www.mtsac.edu/distancelearning/quiz/>**

10270 arrange 9 hours Irvine, C ONLINE

**NOTE:** CRN 10270 is a Distance Learning Online Class.

**How to Begin Course:** Log into Canvas through the e-Learning Tools tab in the Mt.SAC portal at inside.mtsac.edu. Then click on the Canvas link and then click on the CRN to log into your DL course. **NOTE:** Some courses may not be activated until the start of the term. If you cannot locate your DL course in Canvas when the term starts, contact the professor. **On the first day of classes, log into your DL course to show your "attendance" because not doing so could result in your being dropped from the class for non-attendance.**

**Professor contact info:** Email Professor Irvine at either: CIrvine@mtsac.edu, through Student Detail Schedule or Canvas at MyMtSAC Portal.

**Students must use their Mt.SAC e-mail account and be aware of course commitment and student expectations described at <http://www.mtsac.edu/distancelearning/>**

**To prepare for a successful online learning experience, see helpful short videos at <http://www.mtsac.edu/distancelearning/quiz/>**

■ **SOC 5H — Introduction to Criminology - Honors** **3.0 Units**  
(C-ID SOC 160) Degree Applicable, CSU, UC

*Prerequisite:* Acceptance into the Honors Program

A scientific analysis of violations of societal rules of behavior that are defined as crime and delinquency. An honors class.

11055 TWTTh 10:30am - 1:20pm Gatillon, J 21H-1

■ **SOC 20 — Sociology of Ethnic Relations** **3.0 Units**  
(C-ID SOCI 150) Degree Applicable, CSU, UC

*Prerequisite:* Eligibility for ENGL 68

Ethnic and racial groups in the U.S. and social factors leading to prejudice, discrimination, and stereotypes.

10087 TWTTh 7:30am - 10:20am Ramirez, C 26D-2491  
10260 arrange 9 hours Hernandez-Magallon, K ONLINE

**NOTE:** CRN 10260 is a Distance Learning Online Class.

**How to Begin Course:** Log into Canvas through the e-Learning Tools tab in the Mt.SAC portal at inside.mtsac.edu. Then click on the Canvas link and then click on the CRN to log into your DL course. **NOTE:** Some courses may not be activated until the start of the term. If you cannot locate your DL course in Canvas when the term starts, contact the professor. **On the first day of classes, log into your DL course to show your "attendance" because not doing so could result in your being dropped from the class for non-attendance.**

**Professor contact info:** Email Professor Morales-Beasley at either: SMorales2@mtsac.edu, through Student Detail Schedule or Canvas at MyMtSAC Portal.

**Students must use their Mt.SAC e-mail account and be aware of course commitment and student expectations described at <http://www.mtsac.edu/distancelearning/>**

**To prepare for a successful online learning experience, see helpful short videos at <http://www.mtsac.edu/distancelearning/quiz/>**

10271 arrange 9 hours Hernandez-Magallon, K ONLINE

**NOTE:** CRN 10271 is a Distance Learning Online Class.

**How to Begin Course:** Log into Canvas through the e-Learning Tools tab in the Mt.SAC portal at inside.mtsac.edu. Then click on the Canvas link and then click on the CRN to log into your DL course. **NOTE:** Some courses may not be activated until the start of the term. If you cannot locate your DL course in Canvas when the term starts, contact the professor. **On the first day of classes, log into your DL course to show your "attendance" because not doing so could result in your being dropped from the class for non-attendance.**

**Professor contact info:** Email Professor Hernandez-Magallon at either: KHernandezMagallon@mtsac.edu, through Student Detail Schedule or Canvas at MyMtSAC Portal.

**Students must use their Mt.SAC e-mail account and be aware of course commitment and student expectations described at <http://www.mtsac.edu/distancelearning/>**

**To prepare for a successful online learning experience, see helpful short videos at <http://www.mtsac.edu/distancelearning/quiz/>**

## SPANISH

## ■ SPAN 1 — Elementary Spanish 4.0 Units

Degree Applicable, CSU, UC

Conversing, reading, and writing in Spanish at the elementary level.

10236	MTWTh	7:30am - 10:20am	Garcia, V	26B-3561
10237	MTWTh	10:30am - 1:20pm	Louis, I	26B-3561
10238	MTWTh	10:30am - 1:20pm	Ugas-Abreus, B	66-267
10239	MTWTh	1:30pm - 4:20pm	Fuentes, A	66-267

## ■ SPAN 1S — Spanish for the Spanish Speaking 4.0 Units

Degree Applicable, CSU, UC

Provides Spanish-speaking students opportunity to improve skills in standard Spanish grammar and vocabulary. Instruction in Spanish.

10261	MTWTh	10:30am - 1:20pm	Vogel, E	66-248
10262	MTWTh	1:30pm - 4:20pm	Leyva, E	66-248

## ■ SPAN 2 — Continuing Elementary Spanish 4.0 Units

Degree Applicable, CSU, UC

*Prerequisite: SPAN 1*

Further development of conversational, reading, and writing skills in Spanish. Further study of Hispanic culture.

10240	MTWTh	10:30am - 1:20pm	Reyes, A	77-1045
-------	-------	------------------	----------	---------

## SPEECH

## ■ SPCH 1A — Public Speaking 4.0 Units

Degree Applicable, CSU, UC

*Prerequisite: Eligibility for ENGL 68*

Study and apply rhetorical principles to research, write outlines, and deliver speeches. Credit for either SPCH 1A or SPCH 1AH.

10099	MTWTh	7:30am - 10:20am	Castello, A	21A-2
10100	MTWTh	7:30am - 10:20am	Crossman, E	21C-1
10101	MTWTh	7:30am - 10:20am	Musallet, O	21F-1
10102	MTWTh	7:30am - 10:20am	Nahabedian, S	26A-1881
10104	MTWTh	7:30am - 10:20am	Peterson, E	21G-1
10141	MTWTh	7:30am - 10:20am	Solorzano, D	66-209
10163	MTWTh	7:30am - 10:20am	Reynolds, F	26D-G481
10246	MTWTh	7:30am - 10:20am	McLeod, J	21C-2
10105	MTWTh	10:30am - 1:20pm	Arntson, R	18D-1101
10107	MTWTh	10:30am - 1:20pm	Castello, A	21A-2
10109	MTWTh	10:30am - 1:20pm	Crossman, E	21C-1
10110	MTWTh	10:30am - 1:20pm	Musallet, O	21F-1
10112	MTWTh	10:30am - 1:20pm	Peterson, E	21G-1
10140	MTWTh	10:30am - 1:20pm	Reynolds, F	26D-G481

**NOTE:** CRN 10140 above is designed for students in the Summer Bridge Program. Special approval is needed to enroll in this learning community. For more information, please contact (909) 274-5392.

10142	MTWTh	10:30am - 1:20pm	Selnick, S	21H-2
10143	MTWTh	10:30am - 1:20pm	Solorzano, D	66-209
10151	MTWTh	10:30am - 1:20pm	Taylor, W	21I-2
10160	MTWTh	10:30am - 1:20pm	Tuggle, S	26A-1881
10247	MTWTh	10:30am - 1:20pm	McLeod, J	21C-2

**NOTE:** CRN 10247 above is designed for students in the Summer Bridge Program. Special approval is needed to enroll in this learning community. For more information, please contact (909) 274-5392.

10263	MTWTh	10:30am - 1:20pm	Baker, R	21I-1
10106	MTWTh	1:30pm - 4:20pm	Bradshaw, S	26A-2610
10161	MTWTh	1:30pm - 4:20pm	Cantrell, D	26A-1891
10162	MTWTh	1:30pm - 4:20pm	Laverty, J	26D-G481
10198	MTWTh	1:30pm - 4:20pm	Ferguson, C	26A-1881
10202	MTWTh	1:30pm - 4:20pm	Willis, R	26D-G280
10203	MTWTh	4:30pm - 7:20pm	Arntson, R	26D-G280
10217	MTWTh	4:30pm - 7:20pm	Ferguson, C	26A-1881
10218	MTWTh	4:30pm - 7:20pm	Silverstein, A	26A-1891
10219	MTWTh	7:30pm - 10:20pm	Silverstein, A	26A-1891
10276	MTWTh	7:30pm - 10:20pm	Moorehead, A	26D-G280

## ■ SPCH 1AH — Public Speaking - Honors 4.0 Units

Degree Applicable, CSU, UC

*Prerequisite: Acceptance into the Honors Program*

An honors course designed to provide an enriched experience. May not receive credit for both SPCH 1A and SPCH 1AH.

10150	MTWTh	10:30am - 1:20pm	Laverty, J	26D-1411
-------	-------	------------------	------------	----------

## ■ SPCH 20 — Argumentation and Debate 3.0 Units

Degree Applicable, CSU, UC

*Prerequisite: SPCH 1A or SPCH 1AH*

Rhetorical principles of argumentation in both theory and practice. Emphasis given to rational discussion and reasoned advocacy.

10245	MTWTh	10:15am - 12:20pm	Cantrell, D	26A-1891
-------	-------	-------------------	-------------	----------

## ■ SPCH 26 — Interpersonal Communication 3.0 Units

Degree Applicable, CSU, UC

*Prerequisite: Eligibility for ENGL 68*

Dynamics of everyday one-to-one communication.

10114	MTWTh	10:15am - 12:20pm	Willis, R	26D-G280
-------	-------	-------------------	-----------	----------

## STUDY TECHNIQUES

## ■ STDY 85A — Basic Overview of Strategies for Academic Success 1.0 Unit

Not Degree Applicable

College success study techniques course emphasizing memory, motivation, note-taking, test-taking, and time managements strategies.

10388	M	10:15am - 12:05pm	STAFF	6-137
	and M	10:15am - 12:05pm	STAFF	6-137
	and M	10:15am - 12:05pm	STAFF	6-137
		2 hours	STAFF	

**NOTE:** STDY 85A (CRN 10388) is a part of the Pathways Program and is linked to LERN 49 (CRN 10393). **To enroll for Summer 2018 please register for both LERN 49 (CRN 10393) and STDY 85A (CRN 10388).** Your success in this summer program will guarantee your spot in Math 50 and Math 51 in Fall 2018. This class is a part of Math Cohort #1. If you have any questions please email pathways@mtsac.edu or call (909) 274-5703.

**CRN 10388** is a **Hybrid Class** taught partially online with Scheduled Meetings on Campus.

**Other Course Requirements:** n/a.

**How to Begin Course:** Log into Canvas through the e-Learning Tools tab in the Mt.SAC portal at inside.mtsac.edu. Then click on the Canvas link and then click on the CRN to log into your DL course. **NOTE:** Some courses may not be activated until the start of the term. If you cannot locate your DL course in Canvas when the term starts, contact the professor. **On the first day of classes, log into your DL course to show your "attendance" because not doing so could result in your being dropped from the class for non-attendance.**

**Professor contact info:** TBA.

**Students must use their Mt.SAC e-mail account and be aware of course commitment and student expectations described at <http://www.mtsac.edu/distancelearning/>**

**To prepare for a successful online learning experience, see helpful short videos at <http://www.mtsac.edu/distancelearning/quiz/>**

10389	T	10:15am - 12:05pm	STAFF	61-3406
and	T	10:15am - 12:05pm	STAFF	61-3406
and	T	10:15am - 12:05pm	STAFF	61-3406
		2 hours	STAFF	

**NOTE:** STDY 85A (CRN 10389) is a part of the Pathways Program and is linked to MATH 50 (CRN 10427). **To enroll for Summer 2018 please register for both MATH 50 (CRN 10427) and STDY 85A (CRN 10389).** Your success in this summer program will guarantee your spot in Math 51 and Math 71 in Fall 2018. This class is a part of Math Cohort #2. If you have any questions please email [pathways@mtsac.edu](mailto:pathways@mtsac.edu) or call (909) 274-5703.

**CRN 10389** is a **Hybrid Class** taught partially online with Scheduled Meetings on Campus.

**Other Course Requirements:** none.

**How to Begin Course:** Log into Canvas through the e-Learning Tools tab in the Mt.SAC portal at [inside.mtsac.edu](http://inside.mtsac.edu). Then click on the Canvas link and then click on the CRN to log into your DL course. **NOTE:** Some courses may not be activated until the start of the term. If you cannot locate your DL course in Canvas when the term starts, contact the professor. **On the first day of classes, log into your DL course to show your "attendance" because not doing so could result in your being dropped from the class for non-attendance.**

**Professor contact info:** TBA.

**Students must use their Mt.SAC e-mail account and be aware of course commitment and student expectations described at <http://www.mtsac.edu/distancelearning/>**

**To prepare for a successful online learning experience, see helpful short videos at <http://www.mtsac.edu/distancelearning/quiz/>**

10390	W	10:30am - 12:20pm	STAFF	61-2410
and	W	10:30am - 12:20pm	STAFF	61-2410
and	W	10:30am - 12:20pm	STAFF	61-2410
		2 hours	STAFF	

**NOTE:** STDY 85A (CRN 10390) is a part of the Pathways Program and is linked to MATH 51 (CRN 10433). **To enroll for Summer 2018 please register for both MATH 51 (CRN 10433) and STDY 85A (CRN 10390).** Your success in this summer program will guarantee your spot in Math 71 and Math 110 in Fall 2018. This class is a part of Math Cohort #3. If you have any questions please email [pathways@mtsac.edu](mailto:pathways@mtsac.edu) or call (909) 274-5703.

**CRN 10390** is a **Hybrid Class** taught partially online with Scheduled Meetings on Campus.

**Other Course Requirements:** none.

**How to Begin Course:** Log into Canvas through the e-Learning Tools tab in the Mt.SAC portal at [inside.mtsac.edu](http://inside.mtsac.edu). Then click on the Canvas link and then click on the CRN to log into your DL course. **NOTE:** Some courses may not be activated until the start of the term. If you cannot locate your DL course in Canvas when the term starts, contact the professor. **On the first day of classes, log into your DL course to show your "attendance" because not doing so could result in your being dropped from the class for non-attendance.**

**Professor contact info:** TBA.

**Students must use their Mt.SAC e-mail account and be aware of course commitment and student expectations described at <http://www.mtsac.edu/distancelearning/>**

**To prepare for a successful online learning experience, see helpful short videos at <http://www.mtsac.edu/distancelearning/quiz/>**

10858	M	2:25pm - 4:15pm	STAFF	6-134
and	M	2:25pm - 4:15pm	STAFF	6-134
and	M	2:25pm - 4:15pm	STAFF	6-134
		2 hours	STAFF	

**NOTE:** STDY 85A (CRN 10858) is a part of the Pathways Program and is linked to LERN 49 (CRN 10364). **To enroll for Summer 2018 please register for both LERN 49 (CRN 10364) and STDY 85A (CRN 10858).** Your success in this summer program will guarantee your spot in Math 50 and Math 51 in Fall 2018. This class is a part of Math Cohort #4. If you have any questions please email [pathways@mtsac.edu](mailto:pathways@mtsac.edu) or call (909) 274-5703.

**CRN 10858** is a **Hybrid Class** taught partially online with Scheduled Meetings on Campus.

**Other Course Requirements:** n/a.

**How to Begin Course:** Log into Canvas through the e-Learning Tools tab in the Mt.SAC portal at [inside.mtsac.edu](http://inside.mtsac.edu). Then click on the Canvas link and then click on the CRN to log into your DL course. **NOTE:** Some courses may not be activated until the start of the term. If you cannot locate your DL course in Canvas when the term starts, contact the professor. **On the first day of classes, log into your DL course to show your "attendance" because not doing so could result in your being dropped from the class for non-attendance.**

**Professor contact info:** TBA.

**Students must use their Mt.SAC e-mail account and be aware of course commitment and student expectations described at <http://www.mtsac.edu/distancelearning/>**

**To prepare for a successful online learning experience, see helpful short videos at <http://www.mtsac.edu/distancelearning/quiz/>**

## TECHNOLOGY-RELATED COURSES

■ **TECH 60 — Customer Relations for the Technician** **2.0 Units**  
Degree Applicable

Customer relations training (soft skills) for the technician.

11122	TTh	12:00pm - 2:50pm	Uranga, J	28B-312
-------	-----	------------------	-----------	---------

## THEATER ARTS

■ **THTR 9 — Introduction to Theater Arts** **3.0 Units**  
(C-ID THTR 111) Degree Applicable, CSU, UC

Aesthetic, artistic, technical, and business aspects of theater.

10631	MTW	12:45pm - 3:35pm	Cummings, C	1B/C-1
-------	-----	------------------	-------------	--------

<b>■ THTR 11 — Principles of Acting I</b>		<b>3.0 Units</b>	
(C-ID THTR 151)		Degree Applicable, CSU, UC	
Introduction to principles and techniques of acting. Analysis and performance of scenes and monologues.			
10632	MTW	9:45am - 12:35pm	Cummings, C 2-T120
10633	MTW	12:45pm - 3:35pm	Cockrum, D 2-T120

### WELDING

<b>■ WELD 40 — Introduction to Welding</b>		<b>2.0 Units</b>	
		Degree Applicable, CSU	
Fundamentals of welding process related to the areas of construction, machine tool, aerospace, and transportation.			
10033	TWTh	7:30am - 8:20am	Garcia, D 69-6911
	and TWTh	8:30am - 11:20am	Garcia, D 69-6911

<b>■ WELD 51 — Basic Electric Arc Welding</b>		<b>2.0 Units</b>	
		Degree Applicable	

*Advisory: WELD 50*

Electric arc welding, standard electrodes and alloy electrode selection, and AWS procedures for certification.

10001	TWTh	5:30pm - 6:20pm	STAFF 69-6911
	and TWTh	6:30pm - 9:20pm	STAFF 69-6911

<b>■ WELD 53A — Welding Metallurgy</b>		<b>3.0 Units</b>	
		Degree Applicable, CSU	
Structure of matter, physical, mechanical properties of metals, principles of alloying, plastic deformation, heat treatment.			
10038	TWTh	1:30pm - 4:20pm	Garcia, D 69-6911

## Mt. SAC's WELDING TECHNOLOGY PROGRAM

WELDING TECHNOLOGY

**A/C & Refrigeration • Electronics  
Aircraft Fabrication & Repair  
Bridge & High-Rise Construction  
Nuclear Energy • Shipbuilding  
& MORE!**

*Earn a mini-certificate in less than a year or an A.S. degree.*

*For more information, call 909-274-4638*



# Distance Learning Program

## What is Distance Learning?

- Distance Learning means taking online classes that are conducted partially or wholly off campus—“at a distance.” Students and professors communicate with each other using online and other technologies.

## Online Classes

- Online classes are delivered primarily via the Internet and have few or no meetings on campus. See the Schedule note for online classes for any on-campus or other requirements.

## Hybrid Classes

- Hybrid classes are partially delivered via the Internet but also have several or many required on-campus meetings. Students registered for hybrid classes must attend the first on-campus class meeting or they will be dropped from the classes.

## Requirements

- Distance Learning courses require access to a device with Internet connection using the latest browsers, such as Firefox, Safari, Chrome, or Internet Explorer, and using a Mt. SAC student e-mail address.

## Are You Ready for Online Classes?

- Take the online questionnaire for instant results to see if online classes are a good fit for you.  
<http://www.mtsac.edu/instruction/learning/distlearn/quiz/survey1.html>
- Students who have taken online classes found them to be equally or more rigorous than regular classes.
- Strong reading, writing, and time management skills are important to success in online classes, according to students who took online classes.

## Student Complaint/Grievance Process

- Student complaints may fall into three categories: Academic, Non-Academic or Discrimination Complaints. Please consult the current college Catalog or visit <http://www.mtsac.edu/studentlife/studentgrievances.html> for detailed information regarding the student complaint/grievance process.

**For further information regarding Distance Learning, please visit [www.mtsac.edu/college/distlearn/](http://www.mtsac.edu/college/distlearn/), e-mail [distancelearning@mtsac.edu](mailto:distancelearning@mtsac.edu) or call Library & Learning Resources Division at 909-274-5659.**

# 2018 Summer Distance Learning Program

*For complete course information, see the course offerings beginning on page 32.*

## ONLINE LEARNING COURSES

COURSE	TITLE	REFERENCE NUMBER
ADJU 1	The Administration of Justice System	10031
ADJU 4	Legal Aspects of Evidence	10032
ASTR 8	Introduction to Stars, Galaxies, and the Universe	10452
BIOL 5	Contemporary Health Issues	10555
BIOL 15H	Human Sexuality - Honors	10524
BUSA 11	Fundamentals of Accounting	10280
BUSA 68	Business Mathematics	10281
BUSL 18	Business Law	10337
BUSL 19	Advanced Business Law	10326
BUSM 20	Principles of Business	10312
BUSM 61	Business Organization and Management	10340
BUSR 50	Real Estate Principles	10557
CHLD 10	Child Growth and Lifespan Development	10319
CISB 11	Computer Information Systems	10301
CISB 15	Microcomputer Applications	10303, 10304
FCS 41	Life Management	10334
FIRE 1	Fire Protection Organization	10815
FIRE 2	Fire Prevention Technology	10817
GEOG 1	Physical Geography	10124, 10220, 10221
GEOG 2	Human Geography	10125, 10126
HIST 1	History of the United States	10587, 10588, 11124
HRM 51	Introduction to Hospitality	10561
KIN 34	Fitness for Living	10744, 10813
MUS 13	Introduction to Music Appreciation	10663, 10665, 10666, 10667
NF 25	Introduction to Nutrition Science	10336
PHIL 3	Introduction to Logic	10127, 10213, 10243
PHIL 5	Introduction to Philosophy	10128, 10129, 10253, 10255
PHIL 8	Critical Thinking	10130, 10265
PHIL 9	Critical Thinking and Writing	10257, 10267
PHIL 12	Introduction to Ethics	10131, 10214
PHIL 15	Major World Religions	10132, 10133
PSYC 14	Developmental Psychology	10278, 10595, 10596
PSYC 19	Abnormal Psychology	10244, 10769
PSYC 1A	Introduction to Psychology	10134, 10135, 10136, 10158, 10224, 10593
PUBH 24	Introduction to Public Health	10526
PUBH 26	Introduction to Global Public Health	10556
READ 100	Analysis and Critical Reading	10395
READ 90	Reading College Texts	10396
SOC 1	Introduction to Sociology	10137, 10138, 10258, 10268, 10269
SOC 2	Contemporary Social Problems	10252, 10266
SOC 5	Introduction to Criminology	10193, 10215, 10259, 10270
SOC 20	Sociology of Ethnic Relations	10260, 10271



ONLINE-SUPPORTED (HYBRID) COURSES

COURSE	TITLE	REFERENCE NUMBER
ANTH 5	Cultural Anthropology	10772
ANTH 22	General Cultural Anthropology	10771
BUSA 7	Principles of Accounting - Financial	10279, 10322
CISB 11	Computer Information Systems	10300, 10302
CISB 15	Microcomputer Applications	10325
COUN 5	Career and Life Planning	10753, 10754
ENGL 1A	Freshman Composition	10096, 10156, 10211, 10212, 10225, 10610
ENGL 1C	Critical Thinking and Writing	10176, 10216
ENGL 68	Preparation for College Writing	10191
HRM 52	Food Safety and Sanitation	10298
JOUR 100	Introduction to Mass Media	10624
NF 25	Introduction to Nutrition Science	10335
STDY 85A	Basic Overview of Strategies for Academic Success	10388, 10389, 10390, 10858

## 2018 Summer Schedule of Short-Term Classes

### AERONAUTICS

■ **AERO 254 — Aircraft Dispatcher Operations** **4.0 Units**  
 Elements and techniques of aircraft dispatch operations. Includes aircraft dispatcher briefings to a simulated flight crew.

10041	MTWTh	10:15am - 11:40am	Fleming, J	28B-103
	and	MTWTh	11:50am - 1:15pm	Shackelford, S

**8 Weeks, Week beginning 06/21/2018 ending 08/19/2018**

### COUNSELING

■ **COUN 1 — Introduction to College** **1.0 Unit**  
 Higher education and the college experience including educational decision-making and educational planning.

10746	MTWTh	10:30am - 12:45pm	Cuevas-Arella, A	12-1020
-------	-------	-------------------	------------------	---------

**2 Weeks, Week beginning 06/25/2018 ending 07/05/2018**

**NOTE:** CRN 10746 above is designed for first time college students who recently graduated from high school. To enroll in the STEP Program, students must attend an information and registration meeting. Please see the STEP website at [www.mtsac.edu/step](http://www.mtsac.edu/step) to sign up for this meeting. Special Approval is needed to enroll in this 2 week course. For more information about the STEP Program, please email [STEP@mtsac.edu](mailto:STEP@mtsac.edu).

10747	MTWTh	10:30am - 12:45pm	Versace, E	12-1060
-------	-------	-------------------	------------	---------

**2 Weeks, Week beginning 06/25/2018 ending 07/05/2018**

**NOTE:** CRN 10747 above is designed for first time college students who recently graduated from high school. To enroll in the STEP Program, students must attend an information and registration meeting. Please see the STEP website at [www.mtsac.edu/step](http://www.mtsac.edu/step) to sign up for this meeting. Special Approval is needed to enroll in this 2 week course. For more information about the STEP Program, please email [STEP@mtsac.edu](mailto:STEP@mtsac.edu).

10748	MTWTh	10:30am - 12:45pm	Hayward, J	12-1080
-------	-------	-------------------	------------	---------

**2 Weeks, Week beginning 06/25/2018 ending 07/05/2018**

**NOTE:** CRN 10748 above is designed for first time college students who recently graduated from high school. To enroll in the STEP Program, students must attend an information and registration meeting. Please see the STEP website at [www.mtsac.edu/step](http://www.mtsac.edu/step) to sign up for this meeting. Special Approval is needed to enroll in this 2 week course. For more information about the STEP Program, please email [STEP@mtsac.edu](mailto:STEP@mtsac.edu).

10749	MTWTh	10:30am - 12:30pm	Gutierrez, D	12-1020
-------	-------	-------------------	--------------	---------

**2 Weeks, Week beginning 07/09/2018 ending 07/19/2018**

**NOTE:** CRN 10749 above is designed for first time college students who recently graduated from high school. To enroll in the STEP Program, students must attend an information and registration meeting. Please see the STEP website at [www.mtsac.edu/step](http://www.mtsac.edu/step) to sign up for this meeting. Special Approval is needed to enroll in this 2 week course. For more information about the STEP Program, please email [STEP@mtsac.edu](mailto:STEP@mtsac.edu).

10750	MTWTh	10:30am - 12:30pm	Versace, E	12-1060
-------	-------	-------------------	------------	---------

**2 Weeks, Week beginning 07/09/2018 ending 07/19/2018**

**NOTE:** CRN 10750 above is designed for first time college students who recently graduated from high school. To enroll in the STEP Program, students must attend an information and registration meeting. Please see the STEP website at [www.mtsac.edu/step](http://www.mtsac.edu/step) to sign up for this meeting. Special Approval is needed to enroll in this 2 week course. For more information about the STEP Program, please email [STEP@mtsac.edu](mailto:STEP@mtsac.edu).

10751	MTWTh	10:30am - 12:30pm	Hayward, J	12-1080
-------	-------	-------------------	------------	---------

**2 Weeks, Week beginning 07/09/2018 ending 07/19/2018**

**NOTE:** CRN 10751 above is designed for first time college students who recently graduated from high school. To enroll in the STEP Program, students must attend an information and registration meeting. Please see the STEP website at [www.mtsac.edu/step](http://www.mtsac.edu/step) to sign up for this meeting. Special Approval is needed to enroll in this 2 week course. For more information about the STEP Program, please email [STEP@mtsac.edu](mailto:STEP@mtsac.edu).

### EMERGENCY MEDICAL SERVICE

■ **EMS 1 — Paramedic Fundamentals and Selection** **4.0 Units**  
 Assessment and review of EMT competencies and mathematical skills as part of the selection process for EMT - P program.

10053	MTWTh	8:00am - 11:50am	Rincon, P	28B-212
	and	MTWTh	1:00pm - 4:50pm	Jabr, A

**3 Weeks, Week beginning 06/21/2018 ending 07/12/2018**

■ **EMS 2 — Preparation for Paramedic Program** **1.0 Unit**  
 EMT-Basic Skills development for patient assessment and treatment decisions. 911 response team ride-alongs highly recommended.

10054	MTWTh	8:00am - 12:00pm	STAFF	28B-201
	and	MTWTh	1:05pm - 3:30pm	STAFF

**2 Weeks, Week beginning 07/16/2018 ending 07/29/2018**

### ENGINEERING

■ **ENGR 50A — Robotics Team Project Development** **2.0 Units**  
 This course is for members of the Robotics Team. Instructor Approval required. Off-campus competition required.

10683	F	8:00am - 3:30pm	Mason, M	60-1506
-------	---	-----------------	----------	---------

and arrange 10.2 hours Mason, M  
**6 Weeks, Week beginning 06/21/2018 ending 08/01/2018**

## FIRE TECHNOLOGY

<b>■ FIRE 91 — Fire Academy Ladder Orientation</b>				<b>1.0 Unit</b>
Intensive training in ladder manipulation to prepare students for Fire Academy and physical fitness tests given by fire departments.				
10027	M	8:00am - 12:05pm	Dominick, S	CVIFD
and	M	1:00pm - 5:05pm	Dominick, S	CVIFD
		and arrange 32 hours	Dominick, S	CVIFD
<b>1 Weeks, Week beginning 08/20/2018 ending 08/26/2018</b>				
10028	M	8:00am - 12:05pm	Dominick, S	CVIFD
and	M	1:00pm - 5:05pm	Dominick, S	CVIFD
		and arrange 32 hours	Ramirez, B	CVIFD
<b>1 Weeks, Week beginning 08/20/2018 ending 08/26/2018</b>				
10029	M	8:00am - 12:05pm	Dominick, S	CVIFD
and	M	1:00pm - 5:05pm	Dominick, S	CVIFD
		and arrange 32 hours	Ramirez, B	CVIFD
<b>1 Weeks, Week beginning 08/20/2018 ending 08/26/2018</b>				
10030	M	8:00am - 12:05pm	Dominick, S	CVIFD
and	M	1:00pm - 5:05pm	Dominick, S	CVIFD
		and arrange 32 hours	Pollock, L	CVIFD
<b>1 Weeks, Week beginning 08/20/2018 ending 08/26/2018</b>				

## KINESIOLOGY: ATHLETICS

<b>■ KINX 9 — Conditioning for Sports</b>				<b>.5 Unit</b>
Conditioning for athletes to develop muscular strength and endurance, flexibility, core training skills, and cardio fitness.				
10679	TWTh	11:20am - 1:10pm	Crichlow, B	3-1FL
<b>6 Weeks, Week beginning 07/09/2018 ending 08/19/2018</b>				
<b>NOTE:</b> CRN 10679: is limited to intercollegiate Women's Basketball team candidates. No-cost digital textbooks or textual materials used.				
10820	TWTh	1:20pm - 3:10pm	Maloney, C	3-1FL
<b>6 Weeks, Week beginning 06/26/2018 ending 08/02/2018</b>				
<b>NOTE:</b> CRN 10820: is limited to intercollegiate Men's Basketball team candidates. Class begins T, 6/26/18 and ends Th, 8/2/18. No-cost digital textbooks or textual materials used.				
10692	TTh	4:00pm - 7:10pm	Pawley, T	TBA
<b>6 Weeks, Week beginning 07/09/2018 ending 08/19/2018</b>				
<b>NOTE:</b> CRN 10692: is conditioning for intercollegiate Men's and Women's Tennis Team members. First class meeting will be held at the Softball Field. All other class meetings will be held at Citrus College. No-cost digital textbooks or textual materials used.				
<b>■ KINX 88 — Pre-Season Athletics</b>				<b>1.5 Unit</b>
10694	M	7:00am - 10:10am	Roth, A	POOL
and	TWTh	7:00am - 10:10am	Ruh, M	POOL
<b>6 Weeks, Week beginning 07/09/2018 ending 08/19/2018</b>				
<b>NOTE:</b> CRN 10694: is limited to intercollegiate Men's Water Polo candidates. No-cost digital textbooks or textual materials used.				
10695	MTWTh	7:00am - 10:10am	Kamaka, R	44-1900
<b>6 Weeks, Week beginning 07/09/2018 ending 08/19/2018</b>				
<b>NOTE:</b> CRN 10695: is limited to intercollegiate Men's Cross Country candidates. No-cost digital textbooks or textual materials used.				
10696	MTWTh	7:00am - 10:10am	Lanaro, G	44-1900
<b>6 Weeks, Week beginning 07/09/2018 ending 08/19/2018</b>				
<b>NOTE:</b> CRN 10696: is limited to intercollegiate Women's Cross Country candidates. No-cost digital textbooks or textual materials used.				
10759	MTWTh	7:00am - 10:10am	Purper, K	45S
<b>6 Weeks, Week beginning 07/09/2018 ending 08/19/2018</b>				
<b>NOTE:</b> CRN 10759: is limited to intercollegiate Women's Soccer candidates. No-cost digital textbooks or textual materials used.				
10760	MTWTh	7:00am - 10:10am	Ignacio, R	2-T121
<b>6 Weeks, Week beginning 07/09/2018 ending 08/19/2018</b>				
<b>NOTE:</b> CRN 10760: is limited to intercollegiate Pep Squad candidates. No-cost digital textbooks or textual materials used.				
10698	MTWTh	8:00am - 11:10am	Oliver, A	3-1FL
<b>6 Weeks, Week beginning 07/09/2018 ending 08/19/2018</b>				
<b>NOTE:</b> CRN 10698: is limited to intercollegiate Women's Volleyball candidates. No-cost digital textbooks or textual materials used.				

10697	MTWTh	9:00am - 12:10pm	Sanchez, J	45S
<b>6 Weeks, Week beginning 07/09/2018 ending 08/19/2018</b>				
<b>NOTE:</b> CRN 10697: is limited to intercollegiate Men's Soccer candidates. No-cost digital textbooks or textual materials used.				
10756	MW	12:00pm - 6:10pm	Osbourne, G	45G
<b>6 Weeks, Week beginning 07/09/2018 ending 08/19/2018</b>				
<b>NOTE:</b> CRN 10756: is limited to intercollegiate Women's Golf candidates. No-cost digital textbooks or textual materials used.				
10701	MTWTh	5:00pm - 8:10pm	Rivera, D	27C-201
<b>6 Weeks, Week beginning 07/09/2018 ending 08/19/2018</b>				
<b>NOTE:</b> CRN 10701: is limited to intercollegiate Wrestling candidates. No-cost digital textbooks or textual materials used.				

## KINESIOLOGY: INDIVIDUAL

<b>■ KINI 4A — Badminton - Beginning</b>				<b>.5 Unit</b>
10702	TWTh	4:10pm - 6:00pm	Whitlock, M	3-1FL
<b>6 Weeks, Week beginning 06/25/2018 ending 08/02/2018</b>				
<b>NOTE:</b> CRN 10702: Class begins T, 6/26/18 and ends Th, 8/2/18. No-cost digital textbooks or textual materials used.				
<b>■ KINI 4B — Badminton - Intermediate</b>				<b>.5 Unit</b>
10703	TWTh	4:10pm - 6:00pm	Whitlock, M	3-1FL
<b>6 Weeks, Week beginning 06/25/2018 ending 08/02/2018</b>				
<b>NOTE:</b> CRN 10703: Class begins on T, 6/26/18 and ends Th, 8/2/18. No-cost digital textbooks or textual materials used.				

## KINESIOLOGY: TEAM SPORT

<b>■ KINS 2A — Basketball Beginning</b>				<b>.5 Unit</b>
Designed to teach skills, fundamentals, rules and strategies for team play in basketball for the beginner.				
10699	TTh	7:00pm - 9:50pm	Michel, M	3-1FL
<b>6 Weeks, Week beginning 06/25/2018 ending 08/02/2018</b>				
<b>NOTE:</b> CRN 10699: Class begins T, 6/26/18 and end Th, 8/2/17. No-cost digital textbooks or textual materials used.				
<b>■ KINS 2B — Basketball Intermediate</b>				<b>.5 Unit</b>
Skills, fundamentals, rules and strategies for team play in basketball for students with previous-experience.				
10700	TTh	7:00pm - 9:50pm	Michel, M	3-1FL
<b>6 Weeks, Week beginning 06/25/2018 ending 08/02/2018</b>				
<b>NOTE:</b> CRN 10700: Class begins T, 6/26/18 and ends Th, 8/2/18. No-cost digital textbooks or textual materials used.				

## PHOTOGRAPHY

<b>■ PHOT 5 — Digital Cameras and Composition</b>				<b>1.0 Unit</b>
Use of digital cameras and image editing software. Camera required after first class meeting. Field trip required.				
10639	F	6:00pm - 8:05pm	Schaedel, J	13-1455
and	S	9:00am - 4:50pm	Schaedel, J	13-1455
and	Su	9:00am - 4:50pm	Schaedel, J	13-1455
<b>1 Weeks, Week beginning 06/22/2018 ending 06/24/2018</b>				
<b>NOTE:</b> CRN 10639: No-cost digital textbooks or textual materials used				

# 2018 SUMMER

## School of CONTINUING EDUCATION & Noncredit classes

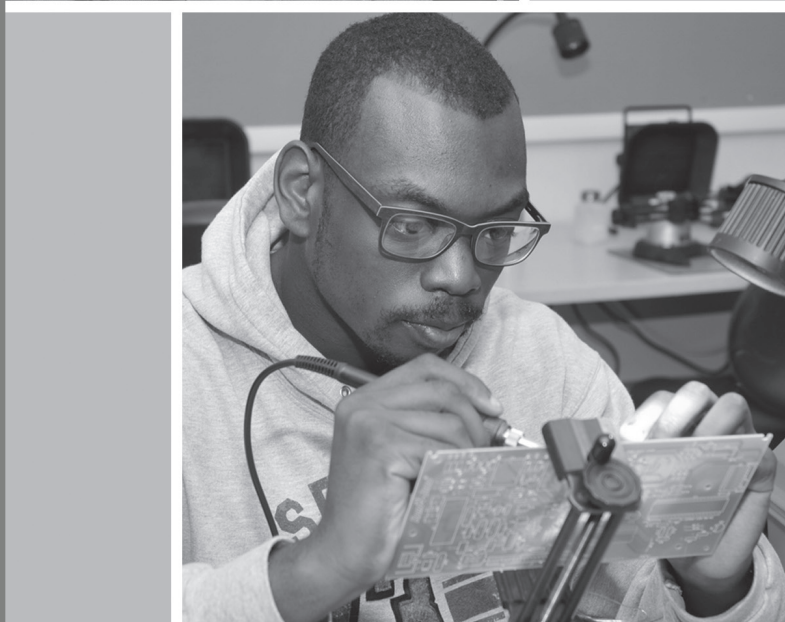
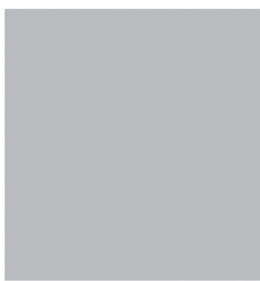

This section contains only the state-funded noncredit adult education courses. All fee-based career and professional development classes, as well as youth programs, recreational, motorcycle, driver education, arts, leisure and all other "community service" programs are compiled online at <http://communityed.mtsac.edu> or call (909) 274-4220.

# 2018 Summer Continuing Education Registration Form

## Mt. SAC School of Continuing Education Registration Form

<b>Print Last Name</b>		<b>First</b>	<b>MI</b>	<b>Former / Maiden Name</b>	<b>Social Security #</b> ____ / ____ / ____
<b>Street Address</b> <input type="checkbox"/> Check if changed in past 3 months				<b>City</b>	<b>Zip</b>
<b>Cell #</b> <input type="checkbox"/> Check if changed in past 3 months		<b>Home #</b>	<b>Work #</b>		<b>Student ID #</b> _____
<b>Text #</b> <input type="checkbox"/> Check if same as cell #		<b>E-mail Address</b>			<b>Date of Birth</b> ____ / ____ / ____
					<b>Sex</b> <input type="checkbox"/> Female <input type="checkbox"/> Male
<b>Student Type</b>		<b>Are you a U.S. Veteran?</b>		<b>Do you live in California?</b>	
X NCR Courses Only		<input type="checkbox"/> Yes <input type="checkbox"/> No		(Circle one) 1 Yes 0 No	
				<input type="checkbox"/> Yes <input type="checkbox"/> No	
<b>Educational Goal: (Circle one)</b>					
A. Associate & Transfer to 4-yr		D. 2-yr Vocational Degree		G. Prep for New Career/Job Skills	
B. Transfer to 4-year w/o Asso.		E. Vocational Certificate		J. Educational Development	
C. 2-yr Associate Degree		F. Discovery-Career Interest/Goal		I. Maintain Certificate/License	
				L. Credit for HS Diploma/GED	
				M. Undecided on Goal	
				N. Move Noncredit to Credit Coursework	
				X. Uncollected/Unreported	
<b>Educational Level: (Circle one)</b>					
0 Non HS Grad & not in HS		3XX High School Diploma		4XX GED/HS Cert of Equivalency	
2 Currently in Adult School		NHS Noncredit High School Student		5XX Cert of CA HS Proficiency	
				6XX Foreign School Diploma	
				7XX Received AA/AS Degree	
				8XX Received Bachelor or Higher	
				X Unknown/Unreported	
<b>Ethnicity and Race: (Select all that apply)</b> <small>Per U.S. Dept. of Education guidelines, colleges are required to collect the following racial and ethnic data.</small>					
Are you of Hispanic or Latino ethnicity? <input type="checkbox"/> Yes <input type="checkbox"/> No		05 Hispanic: Other		09 Asian: Korean	
02 Mexican, Mexican American, Chicano		06 Asian: Indian		10 Asian: Laotian	
03 Central American		07 Asian: Chinese		11 Asian: Cambodian	
04 South American		08 Asian: Japanese		12 Asian: Vietnamese	
				13 Asian: Filipino	
				14 Asian: Other	
				15 Black or African American	
				16 American Indian/Alaskan Native	
				17 Pacific Islander: Guamanian	
				18 Pacific Islander: Hawaiian	
				19 Pacific Islander: Samoan	
				20 Pacific Islander: Other	
				21 White	
<b>Class Selections (List class titles)</b>		<b>CRN</b>	<b>Instructor Name</b>		<b>Class Time</b>
<b>1.</b>					
<b>2.</b>					
<b>3.</b>					
<b>4.</b>					
<b>Student Signature:</b> _____					
<b>Today's Date:</b> _____					
<b>Number of years of school completed:</b> _____ years					
<b>Majority of schooling was outside of U.S.:</b> <input type="checkbox"/> Yes <input type="checkbox"/> No					
<b>Highest Diploma or Degree earned:</b>					
1. None		3. High School Diploma		5. Some college, no degree	
2. HSE Certificate		4. Technical/Certificate		6. A.A./A.S. Degree	
				7. 4 yr. college graduate	
				8. Higher than B.A./B.S.	
<b>I earned my diploma/degree outside of the U.S.:</b> <input type="checkbox"/> Yes <input type="checkbox"/> No					
<b>Native Language: (Circle one)</b>					
A. English		D. Tagalog		G. Korean	
B. Spanish		E. Vietnamese		H. Hmong	
C. Chinese		F. Cambodian		I. Arabic	
				J. Russian	
				K. Farsi	
				L. Somali	
				M. Other _____	
<b>Employment Barriers: (Select all that apply)</b>					
A. Cultural Barriers		D. English Language Learner		G. Homeless	
B. Disabled		E. Ex-Offender		H. Long-term Unemployed	
C. Displaced Homemaker		F. Foster Care Youth		I. Low Income	
				J. Low Levels of Literacy	
				K. Migrant Farmworker	
				L. Seasonal Farmworker	
				M. Single Parent	
				N. No TANF within 2 yrs.	
<b>Labor Force Status: (Circle One)</b>					
A. Unemployed		B. Employed		C. Employed, with notice	
				D. Not in labor force	
<b>Goal 1: (Circle One)</b>					
A. Improve basic skills		D. Get a job		G. Enter college or training	
B. Improve English skills		E. Retain job		H. Work-based project	
C. H.S. Diploma/HSE		F. Get a better job		I. Family goal	
				J. U.S. Citizenship	
				K. Military	
				L. Personal goal	
				M. None	
				N. Other	
<b>Goal 2: (Circle One)</b>					
A. Improve basic skills		D. Get a job		G. Enter college or training	
B. Improve English skills		E. Retain job		H. Work-based project	
C. H.S. Diploma/HSE		F. Get a better job		I. Family goal	
				J. U.S. Citizenship	
				K. Military	
				L. Personal goal	
				M. None	
				N. Other	

# School of Continuing Education 2018 Summer Classes

The School of Continuing Education offers a variety of adult education, personal development, job training, professional certificate and recreational programs for residents in surrounding communities. **The fee-based career and professional development courses are accessible online at <http://feeclasses.mtsac.edu> (Schedule of Classes).** You may call the School of Continuing Education office for more information about the fee-based class schedule at (909) 274-4220.

## CONTENTS

Adult Basic Education.....	87	English as a Second Language (ESL).....	92
High School Referral Program.....	87	Health Careers.....	93-94
Learning Assistance Center.....	89	Education for Older Adults.....	94-98
Supervised Tutoring.....	88	Locations of Off-Campus Classes.....	99
Learning Assistance Resource Center.....	89	Campus Map.....	102-103
The Writing Center.....	89	Continuing Education Program Index.....	101
Noncredit Certificates.....	90-91		
Short-Term Vocational Programs.....	91-92		
Administration of Justice.....	91		
Computer and Networking Technology.....	91		
Photography.....	91		
Welding.....	92		

## School of Continuing Education Registration Instructions

This section outlines the registration and enrollment procedures for Continuing Education courses. Please use the Continuing Education Registration Form on page 84. Registration is continuous throughout the semester, because Continuing Education classes begin and end at different times and for varying durations.

*Please note that Adult Basic Skills and ESL students must complete the required assessment and orientation process before registering for classes. See their respective sections for details.*

## REGISTRATION PROCEDURES

### 1. Register In Person

Registration is conducted in Building 40, Room 122. Enter campus at the Bonita Ave. entrance off Temple Avenue and go north into the campus. **The first day of registration is Wednesday, May 9.**

Summer Registration office hours:

MTWTh 7:30 a.m. - 7:00 p.m.

*Note: The Registration Office will be closed in observance of the Independence Day holiday (Wednesday, July 4).*

### Optional Job Training and Educational Advisement Service:

While registering in person you may want to take advantage of advisement service.

You can schedule a private appointment by calling: (909) 274-4845.

### 2. Register by Fax

- Complete all information on the Registration Form inserted in this Class Schedule, including class title and Course Reference Number (CRN).
- Fax the completed form to: (909) 274-2937.
- Please allow up to three business days to process fax registration.

- You will receive a "Student Schedule Printout" by mail after your registration is processed. All faxed registration forms will be held in the order received and processed beginning at 7:30 a.m. on Wednesday, May 9.

### 3. Register by Mail

- Complete all information on the Registration Form inserted in this Class Schedule. Be sure to include the class title and reference number on the registration form.
- Mail completed form:  
**School of Continuing Education**  
Mt. San Antonio College  
1100 N. Grand Ave.  
Walnut, CA 91788-0911
- A confirming "Student Schedule Printout" will be mailed to you after your registration is processed. *Note: The registration form is included in this Class Schedule for you. All mailed-in registration forms will be held in the order received and processed beginning at 7:30 a.m. on Wednesday, May 9.*

## Class Session Changes & Holidays

The School of Continuing Education reserves the right to make changes in any class. When enrollment in any class is not sufficient to justify its continuance, the class may be terminated. Class dates may change due to instructor/classroom availability.

Most classes will not be held on District holidays. Additional holidays may be observed depending upon off-campus class location. Information will be provided by the instructor.

## REGISTRATION PROCEDURES

### 1. Sign Up for Orientation

- Counselors will help students select appropriate courses and programs to help students succeed in their career of choice. Counseling sessions are conducted in multiple languages. To schedule an appointment, contact the Adult Basic Education Center at (909) 274-4845.

### 2. Register for Classes

- Students must finish the registration process at the Adult Basic Education Center after they have completed assessment and orientation. Students may register for most classes anytime during the semester when space is available within the requested class or program.

### 3. Complete Assessment Process

- Noncredit students enrolling in Basic Skills programs must go through a skills assessment at the Adult Basic Education Center (Building 30) to determine appropriate course selections and to develop an Individual Educational and career Plan.

### Enrollment Fees and Expenses

- Adult Education courses and programs do not have an enrollment fee. However, a material fee may be charged for some courses, payable at the time of registration. Please see the online instructions for fee payment and policies at [www.mtsac.edu/schedule](http://www.mtsac.edu/schedule).

### MT. SAC FARM TOURS

A guided tour of the Mt. SAC farm is available with advanced notice. Each tour is unique and can include such animals as sheep, pigs, cattle, horses, llama, emu, miniature horses, zebu (*miniature Brahma*), and Watusi (*African longhorn cattle*).

The tour takes approximately one hour. Please limit the group size to 60 people (or two classrooms of students).

Tours are available at no cost; however, we would appreciate a donation to help offset the costs for the tour guides.

**Please email [farmtours@mtsac.edu](mailto:farmtours@mtsac.edu)  
or call the Agricultural Sciences Department  
at (909) 274-4540, to arrange for a tour.**

### WILDLIFE SANCTUARY TOURS

Guided tours of Mt. SAC's Wildlife Sanctuary are available with advanced notice. The tours focus on the wonders of nature, exploring water and land ecosystems, studying plant animal habitats, and observing lake, pond, swamp and stream environments. There is a 10-person minimum required for this tour. Due to the enclosed space and narrow pathways at the sanctuary, there is a 30 person maximum.

Tours are available at no cost; however, we would appreciate a donation to help offset the costs for the tour guides.

**Please contact at (909) 274-4794  
to arrange for a tour. Tours are given during  
the fall and spring semesters only.**

- **Parking Fees:** Those who wish to park in the regular student parking lot need a valid Student Parking Permit, which may be purchased online in the student portal. Students may park in the pay lots without a Student Parking Permit. Please see pages 102-103 for general parking information and for parking lot locations.

### Support Services

- **Counseling/Advisement Services:** The Education Advisement Counseling and Assessment areas provide students with resources to explore and identify career options, practice interviewing techniques, and develop their communication and study skills. These services are offered throughout the semester. Call (909) 274-4845.
- **Tutorial Services:** Tutoring is available both in a classroom setting and at the Tutoring Center (Building 6, Room 101).

# 2018 Summer Schedule of Continuing Education Classes

## ADULT BASIC EDUCATION

**Adult Basic Education Center  
Mt. SAC Campus, Building 30  
(909) 274-4845**

**Office Hours:**

MTWTh: 8:00 a.m. - 5:00 p.m.

Dates: June 18 - July 26, 2018

**ABE Learning Center  
(909) 274-4935**

**Lab Days/Hours:**

MTWTh: 8:00 a.m. - 8:00 p.m.

**High School Office  
(909) 274-4937**

**Office Hours:**

MTWTh: 8:00 a.m. - 8:30 p.m.

The Adult Basic Education Center is committed to providing basic skills instruction, high school diploma and equivalency preparation, and support services that prepare students to transition into college and/or employment. Students also receive academic assessment, career assessment, career development, academic advising, and educational planning. All services are offered at no cost and students may register at any time during the semester.

### Adult Basic Education

The Adult Basic Education Lab is available to students on a walk-in basis, offering:

- Courses to strengthen reading, writing, and math
- Development of basic skills necessary for the workplace and college
- Direct instruction and individualized study plan
- Computer-based instruction and small group study
- Counseling and advising

### ASVAB Preparation

Students interested in entering the military can prepare for the Armed Services Vocational Aptitude Battery (ASVAB). Students will be pre-tested and prescribed an adult learning plan to cover deficient areas. Emphasis is placed on assisting students in earning the highest possible score on the official ASVAB exam.

### Computer Literacy/Vocational

The Adult Basic Education Lab offers computer literacy courses in the following software applications:

- MS Office (Word, Excel, PowerPoint, Access, Outlook)
- MS Publisher
- Quickbooks
- Keyboarding
- Internet Applications, Email

### High School Equivalency Exam Preparation

Coursework is offered in the Adult Basic Education Learning Center to prepare students to pass the official General Education Development (GED) test and the High School Equivalency Test (HiSET) exam with the highest possible score. Faculty provide individual learning plans. A cap and

gown graduation is held on the Mt. SAC campus each June to honor students receiving their California High School Equivalency certificate.

### SAT Preparation

Prepare for college-bound exams at the Community Education Center. Long-term preparation is available through the use of the most current SAT exam software.

### Typing Test Certification

Typing tests that certify typing speed for employment applications are open to the public. The ABE Learning Center offers keyboarding software to assist students in increasing their typing speed prior to taking typing tests.

**For more information on any of the above programs, please call the ABE Department at (909) 274-4845.**

### Athletes Can't Lose with WIN

The WIN program, a student athlete tutoring center, is specifically designed to:

- Prepare students to transfer to a four-year institution
- Assist student athletes to maintain academic eligibility

Please call (909) 274-4239 for further information.

### Adult High School Diploma, (909) 274-4937

Adult students can earn credits toward completion of a high school diploma under the guidance of instructors, counselors and support staff. Coursework is offered in small group instruction, computer-aided instruction, and individual study. A cap and gown graduation is held on the Mt. SAC campus each June to honor students receiving their high school diploma.

Credits for required courses and/or electives may be awarded in the following ways:

- Adult School Courses (accredited institutions only)
- Previous High School Courses (accredited institutions only)
- Work Experience (verification required)
- Community College Credit Courses
- Training Programs (accredited institutions only)

**Please call (909) 274-4937 for program information and to schedule an orientation appointment.**

### High School Referral Program

Program description and requirements:

- Students earn deficient high school credits at the Adult Basic Education Center
- Credits are transferred to their school of origin
- Students must obtain a referral form from their high school counselor
- Parents and students must attend a mandatory orientation, made by appointment ONLY, which must be completed prior to attending class

**Please call (909) 274-4937 for dates of instruction and to schedule an orientation appointment.**

## High School Summer Program: May 29 – July 19, 2018

Please contact respective high schools for specific dates, course availability, and registration information.

### ALHAMBRA UNIFIED SCHOOL DISTRICT

Alhambra High School (626) 943-6900  
Mark Keppel High School (626) 943-6700  
San Gabriel High School (626) 943-6800

### BALDWIN PARK UNIFIED SCHOOL DISTRICT

Baldwin Park High School (626) 960-5431  
Sierra Vista High School (626) 960-7741

### BASSETT UNIFIED SCHOOL DISTRICT

Bassett High School (626) 931-2800

### BONITA UNIFIED SCHOOL DISTRICT

Bonita High School (909) 971-8220  
San Dimas High School (909) 971-8230

### CHAFFEY JOINT UNION HIGH SCHOOL DISTRICT

Montclair High School (909) 621-6781

### CHARTER OAK UNIFIED SCHOOL DISTRICT

Charter Oak High School (626) 915-5841

### COVINA VALLEY UNIFIED SCHOOL DISTRICT

Covina High School (626) 974-6020  
Northview High School (626) 974-6120  
South Hills High School (626) 974-6220

### HACIENDA/LA PUENTE UNIFIED SCHOOL DISTRICT

La Puente High School (626) 934-6700  
Los Altos High School (626) 934-5400  
Wilson High School (626) 934-4440  
Workman High School (626) 933-8800

### POMONA UNIFIED SCHOOL DISTRICT

Diamond Ranch High School (909) 397-4715  
Fremont Academy (909) 397-4521  
Ganesha High School (909) 397-4400  
Garey High School (909) 397-4451  
Palomares Academy (909) 397-4539  
Pomona High School (909) 397-4498  
Village Academy High School (909) 397-4900

### ROWLAND UNIFIED SCHOOL DISTRICT

Nogales High School (626) 965-3437  
Rowland High School (626) 965-3448

### WALNUT UNIFIED SCHOOL DISTRICT

Diamond Bar High School (909) 594-1405  
Walnut High School (909) 594-1333

### WEST COVINA UNIFIED SCHOOL DISTRICT

Edgewood High School (626) 939-0600  
West Covina High School (626) 859-2900

### WHITTIER UNION SCHOOL DISTRICT

California High School (562) 698-8121  
La Serna High School (562) 698-8121  
Pioneer High School (562) 698-8121  
Santa Fe High School (562) 698-8121  
Whittier High School (562) 698-8121

## LEARNING ASSISTANCE CENTER

**Building 6, Room 101**  
**Lower Level of the Learning Technology Center**  
**(909) 274-4300**  
**<http://lac.mtsac.edu>**

**Center Hours:**  
MTWTh: 8:00 a.m. - 8:00 p.m.

The LAC helps students succeed in college. The LAC offers courses in basic math, reading, writing, and study techniques. Services also include tutoring, a computer lab, and test monitoring for distance learning courses. Students interested in more information should call (909) 274-4300.

Registration is accepted any time the LAC is open.

### Tutoring

Tutorial Services in the LAC offers tutoring for multiple subjects. Please see the section on "Supervised Tutoring" for more details.

### Learning Lab

The Learning Lab is a computer lab available for all credit and noncredit students. Workshops are offered by appointment to assist students who want more instruction on word processing, E-mail, database/web research, Power Point and course related materials. 107 PCs and 46 MACs along with technical assistance are available for students. Registration for use of the lab is necessary every semester. Students are required to present a current student picture I.D. at the front desk to access the Lab. No food or drinks are allowed in the lab and students are to work on academic material only.

## SUPERVISED TUTORING

**Building 6, Room 101**  
**Lower Level of the Learning Technology Center**  
**(909) 274-6605**

**Office Hours:**  
MTWTh: 10:00 a.m. - 5:00 p.m.

Tutorial Services provides free individual tutoring to students in English, math, and other subjects. Study groups are available for a range of courses, including foreign languages, sciences, and nursing. Additionally, Tutorial Services provides supplemental instruction in over 20 courses.

### Drop-in Tutoring

Tutors in English and math are on duty during regular hours. Drop-in and appointments for writing tutoring are available. Students are encouraged to build study time around their classes — ideally with a tutor — into their daily academic schedule.



## Study Groups

Sessions are designed to give students more focused, small group time with course material. Groups of two or more students are encouraged to keep regular group meetings with a tutor for a maximum of two hours per session.

Register at Tutorial Services counter. For more information, please call (909) 274-6605.

## Online Tutoring

Online tutoring is available for math, English, sciences, foreign languages, and many other subjects through Net Tutor. NetTutor is offered to ALL students of Mt. SAC currently enrolled in any of our classes. NetTutor is accessible through either Moodlerooms or Canvas. Please see the website for more information:

<http://www.mtsac.edu/distancelearning/nettutor.html>

## LEARNING ASSISTANCE RESOURCE CENTER (LARC)

**Building 6, Room 101**  
**Lower Level of the Learning Technology Center**  
**(909) 274-4300**

**Office Hours:**  
MTWTh: 8:00 a.m. - 8:00 p.m.

The LARC provides academic support for students in LERN48 and LERN49 (Math), LERN 81 (Writing), and READ70 and READ 80 courses.

## THE WRITING CENTER

**Building 26B, 1561A**  
**<http://writingcenter.mtsac.edu>**  
**(909) 274-5325**

**Office Hours:**  
MTWTh: 9:00 a.m. - 8:00 p.m.

The Writing Center offers free services to all students who would like help with writing. Students need to bring a current MT.SAC ID to access services.

## Tutoring

The Center provides one-on-one tutoring in writing for any course at the College; CRLA- certified tutors and at least one experienced composition teacher are present at all times. Both walk-in and by-appointment tutoring are available.

## Workshops

In addition, the Writing Center offers a variety of workshops to help students with common writing issues, such as sentence level errors, thesis statements, essay planning and organization, and documentation. These workshops are 40-75 minutes and are taught by experienced composition instructors.

## Services for Non-native English speaking students

The Writing Center offers specific workshops and expert tutoring in writing for students whose native language is not English.

## DLAs (Directed Learning Activities)

Directed learning activities are interactive exercises that target specific issues in grammar or rhetoric. They involve 45-60 minutes of self-directed activity followed by a 15-20 minute tutorial. DLA appointments are also available for students to re-view their DLA assignments with tutors. Professors may assign DLAs or students can choose to work on them independently.

## Computer Lab

The computer lab features grammar software and DSPS stations for DSPS students. Students who are working on DLAs (Directed Learning Activities), who have a tutoring appointment, and/or students who are attending workshops can also use the computer lab as well as students assigned online grammar software. A tutor is also typically available in the lab to answer questions.

## NONCREDIT CERTIFICATES OF COMPLETION/COMPETENCY

### Basic Skills

Basic Skills courses provide training that will improve opportunities for students to obtain employment, advance in their careers or prepare for future advanced academic studies. Students will increase basic skills, i.e., reading, writing, math and computer skills, and progress in this sequence based on individual needs, which results in Basic Skills Certificates of Competency. Courses are offered days and evenings to accommodate work and personal schedules. For more information, please call (909) 274-4845.

### Career Development

Career development provides students with information and guidance on college opportunities, careers and life planning. Students can apply skills gained to their current employment and personal lives, which will improve their opportunities to advance in their careers or transition into a new career. This sequence of courses is offered days and evenings to accommodate adults with alternate schedules. For more information, please call (909) 274-4845.

### English as a Second Language

ESL students are placed within a sequence of courses according to their English abilities. Students progress through the sequence based on individual need before transferring into credit courses or employment. Supplemental courses in speaking, writing, and vocational language will assist their progress through the sequence and may be taken along with ESL level classes as needed. Courses are offered all year long, including winter and summer intersession. Classes are offered days, evenings and weekends. For more information, please call (909) 274-5235.

### Secondary Education

The High School Program provides all courses needed to satisfy requirements for a high school diploma. Students earning a high school diploma increase future employment and educational opportunities, including college and training programs. Completion of these courses will provide the student with a high school diploma. For more information, please call (909) 274-4845.

## NONCREDIT CAREER TECHNICAL EDUCATIONAL CERTIFICATES

California Community College Adult Education Programs are authorized to offer short-term vocational programs with high employment potential. The demonstration of need to offer these programs within the College service area is determined by manpower needs projections from the California Occupational Information System (COTS), or Department of Labor surveys of employers.

### What Are Career Technical Educational Certificates?

Certificates in a variety of career technical education (CTE)/vocational programs are available through the School of Continuing Education. Many of the certificate programs mirror those offered through the credit programs of the College, are favorably recognized by business and industry, and are frequently used as a requirement for professional advancement. Classes taken are noncredit and do not generate college units toward a degree.

**Not all courses are offered every term. If a course needed for Certificate of Completion is not offered in a timely manner, the course may be taken for credit and applied to the noncredit certificate. If the course you need is NOT being offered as a noncredit course, but you see it offered in the credit section of the class schedule, please contact the STV Department office at (909) 274-5757 before registration begins. We will do our best to obtain a noncredit registration for you in the class.**

The School of Continuing Education also offers fee-based certificate programs. These include:

- CPR and First Aid
- Phlebotomy
- Medical Insurance Billing Specialist
- Make-up Artistry
- Water Technology

Specific certificate content and more information can be found in the Continuing Education Schedule of Classes each semester or contact (909) 274-4220.

### How to Finish a Career Technical Education Certificate

In order for students to receive a Certificate of Completion, the student must do the following:

- Register and pay material fees, if required, for desired classes.
- Satisfactorily complete coursework, papers, projects, pass the mid-term and final with the equivalent of a "C" grade as outlined by each individual course syllabus.
- When all courses are completed, submit a request to the School of Continuing Education Office, building 40, Room 109.

If any course for a noncredit certificate program has been taken for college credit, students must contact the School of Continuing Education office, (909) 274-4220, for instructions. Certificate criteria will be verified by the School of Continuing Education staff. If all requirements are met, a Certificate of Completion will be prepared for the student.

### Getting Help

For more information regarding career technical education certificates, please call the STV Department office at (909) 274-5757. Counselors are available to assist students with career and education planning. Please call (909) 274-4220 to schedule an appointment.

### The following noncredit certificates are offered:

#### Accounting:

- Bookkeeping
- Computerized
- Payroll

#### Agricultural Sciences:

- Floral Design
- Horse Ranch Management
- Livestock Management
- Nursery Management
- Pet Science

#### Business Management:

- Business Management - Level 1
- Business Management - Level 2
- Business Management - Level 3
- Human Resource Management
- International Business - Level 1
- International Business - Level 2
- Retail Management - Level 1
- Retail Management - Level 2
- Retail Management - Level 3
- Small Business Management - Level 1
- Small Business Management - Level 2
- Small Business Management - Level 3

#### Electronics:

- Computer and Networking Technology - Level 1
- Computer Systems Technology
- Electronic Assembly and Fabrication
- Electronic Systems Technology - Cabling & Wiring
- Electronic Technology
- Electronics and Computer-Engineering Technology
- Electronics Communications
- Industrial Electronics

#### Health Careers:

- Acute Care Nurse
- Certified Home Health Aide
- Certified Nursing Assistant
- In Home Support Services / Caregiver
- Physical Therapist Aide

#### Manufacturing Technology:

- Manufacturing and Electrical Systems
- MasterCAM

#### Office Technology:

- Administrative Assistant - Level 1
- Administrative Assistant - Level 2
- Essential / General Office Skills
- Office Computer Applications

#### Photographics:

- Photography

**Welding Technology:**

- Welding  
Licensed Welder
- Welding: Automotive Welding, Cutting and Modification
- Welding: Gas Tungsten ARC Welding
- Welding: Semiautomatic ARC Welding

**SHORT-TERM VOCATIONAL**

**ADMINISTRATION OF JUSTICE**

**VOC ADJ01**

**The Administrative Justice System**

History and philosophy of the justice system, subsystems, roles, relationships and theories of crime causation and correction.

10823 MTW 7:30pm - 10:20pm Yagoda, M 28B-204

**COMPUTER AND NETWORK TECHNOLOGY**

**VOC CNT60**

**A+ Certification Preparation**

Prepares the student and qualified computer technician for the A+ Certification Examination. All aspects of the A+ Essentials and A+ Practical Application test modules will be stressed through both lecture review and test simulation software.

10816 TWTh 8:00am - 9:50am Miller, K 28B-404

**VOC CNT62**

**Network+ Certification Preparation**

Prepares the student or A+ certified technician for the Network+ Certification Examination. Includes Open System Interconnection (OSI) model, Transmission Control Protocol/Internet Protocol (TCP/IP), and implementing, installing, maintaining, and supporting networks.

10818 TWTh 10:00am - 11:50am Miller, K 28B-404

**ESSENTIAL / GENERAL OFFICE SKILLS  
CERTIFICATE: VOC CSB15, VOC CSB41, BS ABE05**

This is an introductory course providing instruction in Office Management Skills, Microcomputer Applications (Word, Excel, Powerpoint, Google programs) and Career Development/Work Readiness to prepare students for an entry level position. The program is offered Fall, Spring, and Summer.

**FASHION**

**VOC FSH10**

**Clothing Construction 1**

Essentials of industry standard apparel construction techniques using a variety of machines and equipment. Students will be given instruction in single needle machine operation, industrial overlock operation, and garment assembly.

11134 MTWTh 9:00am - 10:15am Davis, M 78-2160  
and MTWTh 10:25am - 12:30pm Davis, M 78-2160

**ELECTRONIC SYSTEMS TECHNOLOGY - CABLING  
AND WIRING CERTIFICATE: VOC EST 50, 54 & 56**

Students will learn the skills required to prepare them for employment with telephone companies, satellite/cable TV providers, electrical contractors, computer networking companies and home theater/home security retailers. The program is offered in Fall and Spring.

**INTERIOR DESIGN**

**VOC ID10**

**Intro to Interior Design**

Provides a foundation for further training in careers including Interior Design, Furnishings and Maintenance; Interior Decorating; and Environmental Interior Design and Architecture.

10981 MTW 10:00am - 11:50am Tran, N 13-1230

**PHOTOGRAPHY**

**VOC PH004**

**Digital Cameras and Composition**

Use of digital cameras, lenses, filters and exposure to compose quality photographs. Shooting assignments are given for analysis in class. Camera will be required after the second week.

11111 F 06/22 6:00pm - 8:05pm Schaedel, J 13-1455  
and S 06/23 9:00am - 5:00pm Schaedel, J 13-1455  
and Su 06/24 9:00am - 5:00pm Schaedel, J 13-1455

**VOC PH009**

**Digital Image Edit/Photographe**

Software and techniques including digital workflow practices, digital image editing, enhancing and retouching methods commonly used in photography.

11115 MTWTh 12:00pm - 1:20pm Felix, L 13-2425  
and MTWTh 1:30pm - 3:45pm Felix, L 13-2425

**VOC PH010**

**Basic Digital and Film Photography**

Basic mechanical, optical and chemical principles of photography, including digital image systems. Laboratory experience involves problems related to camera and image output techniques.

11112 MTWTh 8:00am - 11:45am Benoe, C 13-1455  
11114 MTWTh 6:00pm - 7:20pm Clark, H 13-1455  
and MTWTh 7:30pm - 9:45pm Clark, H 13-1455  
11113 MTWTh 12:00pm - 3:45pm Benoe, C 13-1455

**VOC PH020**

**Color Photography**

Use of color principles as they relate to commercial and artistic styles. This includes lighting, color theory, color management, exaggerated and unique color schemes applied color psychology principles.

11116 MTWTh 8:00am - 9:20am Perez, J 13-1430  
and MTWTh 9:30am - 11:45am Perez, J 13-1430

**VOC PH021**

**Exploring Color Photography**

Use of color principles as they relate to commercial and artistic styles and innovative use of color applications. Includes lighting and unusual techniques, exaggerated and unique color schemes, light-painting, lighting effects, high dynamic range effects and oversize output.

11117 MTWTh 8:00am - 9:20am Perez, J 13-1430  
and MTWTh 9:30am - 11:45am Perez, J 13-1430

## WELDING

### VOC WL40

#### Introduction to Welding

Fundamentals of welding processes related to the areas of fabrication, construction, machine tool, aerospace and the transportation industries.

10819	TWTh	7:30am - 8:20am	Garcia, D	69-6911
	and TWTh	8:30am - 11:20am	Garcia, D	69-6911

### VOC WL51

#### Basic Electric Arc Welding

Electric arc welding, weld symbols, standard electrode and alloy electrode selection, American Welding Society (AWS) procedure for certification.

10821	TWTh	5:30pm - 6:20pm	Kuchta, J	69-6911
	and TWTh	6:30pm - 9:20pm	Kuchta, J	69-6911

### VOC WL53A

#### Welding Metallurgy

Designed for students seeking a career in welding and welding inspection. Covers structure of matter, chemical, physical and mechanical properties of metals, principles of alloying, solid state diffusion, plastic deformation and heat treatment.

10822	TWTh	1:30pm - 4:20pm	Garcia, D	69-6911
-------	------	-----------------	-----------	---------

## MANUFACTURING AND ELECTRICAL SYSTEMS CERTIFICATE

Students will learn manufacturing theory including Lean Manufacturing and waste elimination management; components of and how to read blueprints; manufacturing and production principles including torque; basic assembly techniques; use of materials and manual and power tools; safety; electrical systems; troubleshooting electrical circuits; quality control; diagnostics investigation; fundamentals of welding processes; tools for the transportation industry and business management techniques. The program is offered in Fall and Spring.

## STUDENTS WITH DISABILITIES PROGRAMS AND SERVICES

### DSPS LRND2

#### High Tech Center: Assistive Technology and Academic Strategies

Technology and academic strategies to assist students in accessing information and completing credit class assignments. Students should be registered with DSPS and enrolled in at least 3 academic units.

10780	MTWTh	8:00am - 5:00pm	Ponce, H	9E-1105
-------	-------	-----------------	----------	---------

### DSPS LRND3

#### Acquired Brain Injury Intervention

Designed for students who have been accepted into the Acquired Brain Injury Program at Mt. SAC. Specialized instruction and the use of computer software to improve cognitive skills (attention, memory, reasoning, etc) needed for academic and vocational goals. Note: Students must see a brain injury specialist in Disabled Student Programs and Services (DS-PandS), have acquired their injury after the age of 12, and have finished with any services through the public school system in order to be eligible to register in this class.

10784	MTWTh	8:00am - 5:00pm	Ponce, H	9E-1190
-------	-------	-----------------	----------	---------

## ENGLISH AS A SECOND LANGUAGE (ESL)

**Building 66 (Language Center), Lower Level  
Mt. SAC Campus  
(909) 274-5235  
Email: [eslreg@mtsac.edu](mailto:eslreg@mtsac.edu)  
Website: [www.mtsac.edu/esl](http://www.mtsac.edu/esl)**

Our goal is to help students strengthen their English communication skills, assist students with their future college and career success, and support as a member of their community.

**Summer Intersession: June 25 – August 10, 2018.**

### Steps to Enrollment:

1. **Come in person** to ESL, Building 66/Language Center, lower level. The placement test is offered every Thursday.
2. **Assessment and Placement** — Take the ESL placement test to assign the correct course level for your English ability.
3. **Registration** — We will register you immediately after you complete the placement test. If classes are full, we will add you to a waiting list and contact you when space is available.

*Note: New student testing is offered every Thursday.*

### Thursday testing times are:

**Morning Classes:** 8:30 and 11:00 a.m.

**Evening Classes:** 4:30 and 7:00 p.m.

Check-in begins 30 minutes before each test. A photo ID is required to take the placement test. Please allow 2 hours for testing, orientation, and registration. There will be no testing on holidays.

For registration, call (909) 274-5235 or email [eslreg@mtsac.edu](mailto:eslreg@mtsac.edu).

### One of the following levels will be recommended:

#### Pre-level:

For students with no experience in English. Learn to recognize and use common English words.

#### Levels 1 & 2:

Develop basic spoken and written English for everyday needs. Speak and write about personal interests and life experiences.

#### Levels 3 & 4:

Build communication skills and monitor the language learning process. Increase conversational fluency, vocabulary development and grammar accuracy.

#### Levels 5 & 6:

Focus language learning toward personal academic and vocational goals. Integrate language skills with lifelong learning strategies necessary for successful transition into college credit programs and/or a vocation.

#### Other Class Options:

#### Speaking Skills P1, A, B, & C:

Listening and speaking including vocabulary development, idioms and pronunciation and every day conversation practice. For literacy (P1), beginning (A), intermediate (B) and advanced (C) students.

**Writing Skills P1, A, B, & C:**

Reading and writing including basic vocabulary, spelling, writing sentences, paragraphs and simple essays using familiar topics and American customs. For literacy (P1), beginning (A), intermediate (B) and advanced (C) students.

**TOEFL Preparation:** Preparation for the TOEFL Test (computer version) for advanced students. For information call (909) 274-5235 or email [eslreg@mtsac.edu](mailto:eslreg@mtsac.edu).

**Citizenship:** Preparation for students preparing to pass the USCIS interview for citizenship.

**Career & Life Planning:** The VESL Career & Life Planning course introduces students to different aspects of the world of work. Students learn decision-making strategies, teamwork skills, and job-related skills, such as job search, interviewing, and resume writing.

**VESL Career Paths**

This is a two-semester program designed to prepare advanced ESL students for academic and career success. VESL Career Paths combines courses in oral and written communication, career and life planning, and computer skills to help students move into college credit programs that lead to certificates and degrees. These courses are also designed to improve the chances of a job promotion or career progress for students with employment as their main goal. Students must successfully complete the two-semester program in order to receive a certificate. Contact the VESL Program Coordinator at (909) 274-5236, for more information.

*Note: New students can enroll in the VESL Program in the Fall and Spring semesters.*

**Language Learning Center (LLC)**

The Language Learning Center (LLC) offers a wide variety of language learning software, videos, DVDs and recordings to improve listening, speaking and pronunciation skills for the following languages:

- American Language
- Arabic
- Chinese
- English as a Second Language
- French
- German
- Italian
- Japanese
- Sign Language
- Spanish

Enrollment is open throughout the semester to everyone. Register at the LLC front desk. ESL students may register in ESL registration office.

**Location:** Learning Technology Center (Building 77, room 1005).

*Note: LLC is closed during the first and last week of spring semester*

**Dates:** June 25 - July 26, 2018

**Times:** Please check the website for current hours.

Get more information on our website

at <http://www.mtsac.edu/llc> or call (909) 274-4580.

**HEALTH CAREERS**

**Health Careers Resource Center  
Mt. SAC Campus, Building 67B, Room 250  
(909) 274-4788**

The HCRC provides a state-of-the-art learning lab environment to:

- Update prior or current health skills/knowledge
- Participate in simulated clinical activities
- Provide "hands on" practice

The center is open to credit and noncredit health career students.

**HEALTH CAREERS: SHORT TERM VOCATIONAL TRAINING CERTIFICATES, BLDG. 40, ROOM 101**

*For additional information and how to register for these courses, please call (909) 274-4220.*

**Acute Certified Nursing Assistant Certificate  
VOC HTH04**

The Acute Care Nursing Assistant class is an additional 96 hours beyond the CNA program. This includes 32 hours of theory and 64 hours of clinical. Students who took the CNA program and passed the State Exam are eligible for the program. The Acute Care Nursing Assistant is a CNA who works in various departments of acute care hospitals. The program is offered in Spring and Fall.

**Certified Nursing Assistant (CNA)  
VOC HTH01, VOC HTH05**

The School of Continuing Education (SCE) Certified Nursing Assistant (CNA) Program at Mt. San Antonio College provides the participant with the knowledge and skills to be eligible to take the state certification exam and work as an entry level healthcare provider with patients in a variety of healthcare settings. Course content may increase chances for successful admission to an LVN or RN program.

**Home Health Aide Certification  
VOC HHA**

Eligible students are those who have completed the CNA program and passed the State exam. The course provides an additional 42 hours of training, 21 hours each in theory and clinical. The program is offered in Spring and Fall.

**In-Home Support Services Caregiver Training Program Summer 2018**

This FREE 7-week training prepares students for employment as a Personal Home Care Aide/Caregiver. The program educates students to assist elderly, disabled and ill individuals with activities of daily living at home, in an assisted living facility or at an adult day center. Students learn skills in personal hygiene, safe transfer techniques, and stages of Alzheimer's and dementia. Included in the program is a hands-on lab as well as career development and job placement assistance. Mandatory orientations for the summer 2018 class will be held in May and June 2018 and will provide the schedule and class information. For orientation, dates and program information please call 909-274-4220.

**Physical Therapist Aide  
VOC HTH 12, VOC PT81**

This course will provide students with a basic understanding of working in a physical therapy setting with patients who need rehabilitation. The course includes medical terminology used in the profession. The program is offered Fall, Spring and Summer.

## Health Careers Resource Center Available Services

- RN assistance in clinical skills practice and performance evaluation
- Medical and hospital equipment/supplies/ manikins/ simulators/ training aides for hands-on demonstrations and application of basic, intermediate and advanced skills
- Health Skills Performance Update/Evaluation
- Clinical simulations for Med-Surg, Psych, OB, Peds, Perioperative, Critical Care.
- METI Adult, Child, and Infant Human Patient Simulators

## Required Registration for the HCRC

HCRC registration is open during the entire semester to students who are concurrently enrolled in a credit or non-credit health occupation course. Prior to utilization of the HCRC, students must pre-register in the Continuing Education Division Registration Office, Building 40, Room 101. Registration receipt and current student identification must be brought to the HCRC on the first visit to complete the registration process.

## Student Identification

Students must also bring their current MT. SAC PHOTO I.D. card to the center on each visit. I.D. cards are available for \$10 at the Bursar's Office (Bldg. 4).

## Hours of Operation

**June 21 - August 1, 2018**

**Days:** MTWTh

**Times:** 8:00 a.m. - 5:00 p.m.

R.N. is available 10:00 a.m. - 3:00 p.m. Monday - Wednesday. Special workshops will be offered Monday-Thursday from 10:30 a.m. - 12:30 p.m. - please refer to the workshop flier posted in Bldg 67A & 67B for dates, topics, and sign-up process. If you have any questions, please call HCRC at (909) 274-6437.

## VOC HTH05

### Health Careers Skills Lab (HCRC)

Health occupational training and experience using instructional equipment and simulators for health occupation competencies.

- 11033 Associates Degree Nursing Program
- 11036 Bachelor Degree Nursing Program
- 11040 Continuing Education
- 11042 CNA/Acute CAN
- 11043 Medical Services-EMT, Paramedic, PA Prep
- 11044 Mental Health/Psych Tech Program
- 11045 Respiratory Therapy Program
- 11046 Radiology
- 11047 Phlebotomy
- 11049 Health Care Interpreting
- 11050 Home Health Aide
- 11051 In Home Support

## NURSING ASSISTANT PROGRAM (CNA) ORIENTATION FOR SUMMER INTERSESSION 2018 CLASS

A detailed schedule of exact dates and times of classes will be provided at the orientation meeting. Mandatory orientation for Summer 2018 will be held during the Spring 2018 semester. For more information, call (909) 274-5757.

## VOC RDTEC

### IV Therapy for Radiology Technology

Principles and techniques of venipuncture. Includes anatomy and physiology of sites, instruments, intravenous (IV) solutions, equipment, puncture techniques, hazards and complications, emergency care, post-puncture care.

10924	M	06/25	8:00am - 11:10am	Riley, J	67A-150
	and M	06/25	11:20am - 4:40pm	Riley, J	67A-150
	and T	06/26	8:00am - 10:10am	Riley, J	67A-150
	and T	06/26	10:20am - 3:10pm	Riley, J	67A-150
	and W	06/27	9:00am - 12:10pm	Riley, J	67A-150
	and W	06/27	12:20pm - 3:10pm	Riley, J	67A-150
	and Th	06/28	8:00am - 12:10pm	Riley, J	67A-150
	and Th	06/28	12:20pm - 5:10pm	Riley, J	67A-150

## EDUCATION FOR OLDER ADULTS

Classes begin the week of June 25 and end August 19, unless stated otherwise.

Mt. San Antonio College Continuing Education Division offers classes for older adults on campus and at various senior and community centers, and residential facilities throughout the area. Courses in this section are designed and developed to meet the educational needs of older adults. However, persons age 18 or over may enroll. For more information, call (909) 274-4192.

## COMPUTER SKILLS

**NOTE:** Computer Registration Dates and Locations:

(All Computer classes including digital photography and Internet)

Each person must register for himself/herself. Students may not register for anyone else. Students may register for only one class. Registration for new computer students is first come first served.

Note: the student is permitted to take the computer class only two (2) times consecutively

- Walnut Senior Center- 5/14/18 from 10:00-11:00 a.m. (Monday.)
- La Verne Community Center- 5/15/18 from 10:00-10:30 a.m. (Tuesday)
- San Dimas Com. Center- 5/16/18 from 10:00-11:00 a.m. (Wed)
- West Covina Senior Center- 5/17/18 from 10:00-10:30 a.m.(Thursday)
- Shadow Oak Park - 5/18/18 from 10:00-10:30 a.m.(Friday)
- Palomares Senior Center- First day of class
- Steinmetz Senior Center- First day of class
- Pathfinder Park - First day of class

**VOC CPBC1**

**Basic Computing - Level 1**

Introduction to the personal computer, including terminology and basic computer operations in a Windows environment.

10767	Th	8:55am - 12:00pm	Kretschmar, J	WCSCC
10774	T	9:00am - 12:05pm	Mc Farlin-Stagg, Z	LV
10778	T	11:40am - 2:45pm	Rzonca, S	WALT
10775	T	12:25pm - 3:30pm	Miranda, B	SD
10766	Th	12:55pm - 4:00pm	Jones, V	PATH

**VOC CPBC2**

**Basic Computing - Level 2**

Create documents in applications such as Microsoft Word; includes basic computer maintenance and problem-solving techniques.

10782	M	8:55am - 12:00pm	Miranda, B	PSC
10781	W	8:55am - 12:00pm	Bloom, D	WCSCC
10783	W	8:55am - 12:00pm	Miranda, B	SD
10788	Th	11:40am - 2:45pm	Rzonca, S	WALT

**VOC CPBC3**

**Basic Computing - Level 3**

Software application skills including creative projects which introduce computer graphics.

10790	M	8:25am - 11:30am	Jones, V	WCSCC
10794	Th	8:25am - 11:30am	Rzonca, S	WALT
10789	M	8:55am - 12:00pm	Bloom, D	WCSCC
10791	T	8:55am - 12:00pm	Miranda, B	PSC
10795	Th	8:55am - 12:00pm	Smith, H	SOP
10796	T	9:00am - 11:50am	White, S	SD
10793	F	9:00am - 11:50am	Moreno, M	LV

**VOC CPCC**

**Creative Computing**

Creative skills in utilizing graphic designs for projects such as business cards, letterhead, labels, flyers, posters, greeting cards, and computer-generated fabric designs.

10799	T	8:25am - 11:30am	Rzonca, S	WALT
10798	F	8:55am - 12:00pm	Miranda, B	SD
10800	F	9:00am - 11:50am	Tom, A	WCSCC
10801	F	11:30am - 2:35pm	Kretschmar, J	66-228
10797	TTh	12:30pm - 2:00pm	Kretschmar, J	SOP

**VOC CPDI**

**Digital Photography for the Beginner**

Digital camera operations, image management, composition, and use of graphics software.

10805	M	9:00am - 11:50am	Tom, A	WALT
10804	T	9:00am - 11:50am	Tom, A	SOP
10802	Th	9:00am - 11:50am	Tom, A	SD
10803	T	12:30pm - 3:20pm	Tom, A	WCSCC

**VOC CPNET**

**Internet Research - an Introduction**

Fundamental Internet functions including terminology, email, search engines and research tools.

10812	W	8:30am - 11:35am	Ortiz, C	WCSCC
10808	T	8:55am - 12:00pm	Kretschmar, J	WCSCC
10833	W	8:55am - 12:00pm	Smith, H	SOP
10810	M	9:00am - 11:50am	Moreno, M	SD
10834	W	9:00am - 11:50am	Tom, A	PSC
10809	Th	9:00am - 11:50am	Miranda, B	LV
10807	F	9:00am - 12:05pm	Jones, V	WALT
10811	M	11:30am - 2:35pm	Ortiz, C	66-238
10806	T	12:55pm - 4:00pm	Jones, V	PATH

**DECORATIVE/HOME AND FINE ARTS**

**OAD FNA03**

**Oil Painting**

Principles of drawing, design, color and composition for oil painting emphasizing creative skill development for the older adult population.

11023	Th	8:00am - 11:50am	Conte, K	WALT
-------	----	------------------	----------	------

**NOTE:** Walnut Senior Center: General Registration Date for the Following Classes: 5/14/18 from 10:00-11:00 a.m. (Monday) Note this is for classes held at Walnut Senior Center only. Oil Painting, Home Gardening, Beginning Decorative Art Production for Retail Sales, Healthy Aging Principles of Slow Movement, and all Computer Classes including Digital Photography. Each person must register for himself/herself. Students may not register for anyone else.

**OAD FNA04**

**Watercolor Painting**

Principles of watercolor painting for the older adult population. Emphasis will be on creative expression to develop primary skills for watercolor as they relate to composition and technique.

11027	W	8:45am - 11:35am	Conte, K	CCHCH
11034	M	9:00am - 11:50am	Conte, K	MAS
11032	T	9:00am - 11:50am	Conte, K	LV
11031	F	10:00am - 12:50pm	Conte, K	WCSCC
11038	W	12:55pm - 4:00pm	Smith, H	PATH
11037	Th	12:55pm - 4:00pm	Smith, H	DBC
11039	F	12:55pm - 4:00pm	Tucker, R	LV
11035	T	1:00pm - 3:50pm	Conte, K	SD

**OAD FNA32**

**Drawing-Beginning Through Advanced**

Perceptual and technical skills of drawing. Includes dry and fluid media for the older adult population. Focus on single objects, still life and landscape.

11052	Th	8:55am - 12:00pm	Tucker, R	LV
11041	T	12:30pm - 3:35pm	Tucker, R	DBC
11048	M	1:00pm - 4:05pm	Tucker, R	HERI

**HOME-BASED BUSINESS**

**VOC AGR-G**

**Home Gardening**

Organic gardening, plants, fruit orchards, and traditional gardening for the older adult population, including design, propagation methods, pruning, fertilizing, and pest control.

10761	M	10:00am - 11:50am	Williams, S	PATH
10644	W	10:00am - 11:50am	Williams, S	DBC
10765	Th	10:00am - 11:50am	Williams, S	WCSCC
10640	F	11:30am - 1:20pm	Williams, S	40-140
10645	M	1:00pm - 2:50pm	Williams, S	LEES
10758	T	1:00pm - 2:50pm	Williams, S	LV
10762	W	1:00pm - 2:50pm	Williams, S	SD
10764	Th	1:00pm - 2:50pm	Williams, S	WALT

**NOTE:** Walnut Senior Center: General Registration Date for the Following Classes: 5/14/18 from 10:00-11:00 a.m. (Monday) Note this is for classes held at Walnut Senior Center only. Oil Painting, Home Gardening, Beginning Decorative Art Production for Retail Sales, Healthy Aging Principles of Slow Movement, and all Computer Classes including Digital Photography. Each person must register for himself/herself. Students may not register for anyone else.

**VOC ESD03**

**Lettering Styles and Advertising Calligraphy**

Styles of calligraphy as they are used in art, media, and advertising for the older adult population. Includes size, placement, styles, and emerging technology.

10855	W	12:30pm - 2:20pm	Rafter, J	WCSCC
-------	---	------------------	-----------	-------

**VOC ESD07**

**Handcrafted Needlework for Retail Sales**

Needlework technique including knitting, crocheting, embroidery, needlepoint for plastic canvas, and emerging technology to construct finished products for sale.

10856	Th	8:25am - 11:30am	Beightol, D	LEES
10859	Th	8:55am - 12:00pm	Henry, P	DBC
10857	T	9:25am - 12:30pm	Beightol, D	SD

**VOC ESD08**

**Jewelry Production and Design for Retail Sales**

Design and construct wire-worked jewelry using beads and stones with various methods of wire wrapping, coiling, hammering, and emerging technology.

10860	Th	8:55am - 12:00pm	Paphatsarang, B	RIOVER
10861	F	8:55am - 12:00pm	Paphatsarang, B	SD

**NOTE:** San Dimas Senior/Community Center: Jewelry- 5/18/18 at 9:00am. (Friday). Registration cards will be handed out. 30 completed registration cards will be randomly drawn for class. Each person must be present during the registration process and may only register for him or herself. Students may not register for another student

10862	F	12:55pm - 4:00pm	Paphatsarang, B	WALT
-------	---	------------------	-----------------	------

**NOTE:** Walnut Senior Center: Jewelry- 5/25/18 at 1:00 pm. (Friday). Registration cards will be handed out. 30 completed registration cards will be randomly drawn for class. Each person must be present during the registration process and may only register for him or herself. Students may not register for another student at this time.

**VOC ESD09**

**Sewing and Design**

Basic sewing techniques for the older adult population, including basic tailoring, pattern reading, cutting, and style design to construct professional looking garments.

10868	W	8:55am - 12:00pm	Stringfellow, S	RIOVER
10865	M	9:00am - 12:05pm	Stringfellow, S	LV
10863	Th	9:00am - 12:05pm	Stringfellow, S	DBC
10866	M	12:25pm - 3:30pm	Stringfellow, S	LV
10867	W	12:25pm - 3:30pm	Stringfellow, S	RIOVER
10864	Th	12:25pm - 3:30pm	Stringfellow, S	DBC
10869	M	5:25pm - 8:30pm	Stringfellow, S	SD

**VOC ESD10**

**Beginning Decorative Art Production for Retail Sales**

Introduction to decorative painting and associated mediums for the older adult population, including painting on a variety of surfaces using tole art brush strokes used in folk art, stenciling and other design applications and emerging technology.

10978	M	12:55pm - 4:00pm	Beightol, D	IRWN
11019	Th	1:30pm - 3:45pm	Conte, K	WCSCC

**VOC ESD11**

**Intermediate Decorative Art Production for Retail Sales**

Intermediate tole art brush strokes on a variety of surfaces using acrylic paints, associated mediums, and emerging technology to create finished products for the older adult population.

11021	Th	1:00pm - 4:05pm	Beightol, D	SD
11020	M	5:55pm - 9:00pm	Beightol, D	LV

**VOC ESD15**

**Jewelry and Lapidary Production Design**

Jewelry making, stone cutting, polishing, and lapidary work, using emerging technology.

10835	S	8:55am - 12:00pm	Velarde, M	28B-410
-------	---	------------------	------------	---------

**VOC HBB1**

**Starting a Home-Based Business**

Starting a home-based business to become self-employed. Includes basic marketing, finance and management skills.

11054	M	8:55am - 12:00pm	Tucker, R	LV
-------	---	------------------	-----------	----

**HEALTH**

**OAD MOX01**

**Healthy Aging**

Healthy aging, including diet, nutrition, disease prevention, and application of physical fitness principles to maintain health while aging.

**NOTES:** Walnut Senior Center: Healthy Aging Registration- 5/21/18 at 8:45a.m. (Monday). Registration cards will be handed out. 70 completed registration cards will be randomly drawn for each class. Each person must be present during the registration process and may only register for him or herself. Students may not register for another student at this time. Students may register for only one Healthy Aging Class.

Diamond Bar Center: Healthy Aging- 5/23/18 at 9:00am. (Wednesday). Registration cards will be handed out. 30 completed registration cards will be randomly drawn for each class. Each person must be present during the registration process and may only register for him or herself. Students may not register for another student at this time. Students may register for only one Healthy Aging Class.

Pathfinder Park Community Center: Healthy Aging- 5/24/18 at 11:00 am. (Thursday). Registration cards will be handed out. 70 completed registration cards will be randomly drawn for class. Each person must be present during the registration process and may only register for him or herself. Students may not register for another student at this time.

West Covina Senior Center: Healthy Aging - 5/30/18 at 10:00 am (Wednesday)

11136	F	7:25am - 8:30am	Jones, V	HERI
11129	MWF	8:00am - 8:50am	Cena, A	DBC
11151	MWF	8:00am - 8:50am	Overoye, S	SOP
11156	MWF	8:00am - 8:50am	Tamburro, M	WALT
11152	TTh	8:00am - 9:20am	Rohrenbacher, J	LV
11154	TTh	8:00am - 8:50am	Tamburro, M	PLUM
11147	T	8:45am - 9:35am	Moreno, M	COV-AT
11126	F	8:45am - 9:50am	Baker, N	BRDG
11135	MTWTh	8:55am - 10:00am	James, D	RAN
11163	MW	9:00am - 9:50am	STAFF	WCSCC
11130	MWF	9:00am - 9:50am	Cena, A	DBC
11153	MWF	9:00am - 9:50am	Suarez, M	VILA
11157	MWF	9:00am - 9:50am	Tamburro, M	WALT
11127	TTh	9:00am - 10:05am	Bresciani, A	VILA
11137	TTh	9:00am - 10:05am	Jones, V	LEES
11168	TTh	9:00am - 9:50am	Velarde, M	BRDG
11150	W	9:00am - 9:50am	Overoye, S	COUN
11140	F	9:00am - 9:50am	Ledezma, E	WCSCC
11169	F	9:00am - 9:50am	Velarde, M	RAN
11138	W	9:25am - 10:30am	Jones, V	SD
11165	M	9:30am - 10:20am	Trimble, J	SD
11162	F	9:30am - 10:20am	STAFF	SD
11164	MW	10:00am - 10:50am	STAFF	WCSCC
11131	MWF	10:00am - 10:50am	Cena, A	DBC
11159	MW	7:30am - 8:35am	STAFF	HERI
11160	TTh	10:00am - 10:50am	STAFF	PATH
11148	WTh	10:00am - 10:50am	Moreno, M	LPSC
11144	F	10:00am - 10:50am	Ledezma, E	WCSCC
11166	F	10:00am - 10:50am	Trimble, J	SDMS
11128	W	10:25am - 12:00pm	Bresciani, A	WALT
11167	M	10:30am - 11:20am	Trimble, J	WPK
11170	TTh	10:30am - 11:20am	Velarde, M	RGNT
11149	F	10:30am - 11:20am	Suarez, M	LPSC
11171	F	10:30am - 11:20am	Velarde, M	WPK
11139	W	10:40am - 11:45am	Jones, V	WPK
11155	MWF	11:00am - 11:50am	Tamburro, M	PSC
11161	TTh	11:00am - 11:50am	STAFF	PATH
11132	W	1:00pm - 1:50pm	Cena, A	ESGVJC
11146	Th	1:00pm - 1:50pm	Moreno, M	IRWN
11145	F	1:00pm - 1:50pm	Miranda, B	IRWN
11133	MF	1:25pm - 2:30pm	Cena, A	MSAG
11158	S	9:00am - 9:50am	Tan, J	COUN



**LOCATION CODES FOR OLDER ADULT PROGRAM**

<b>BRDG</b> Bridgecreek Retirement Center	<b>IRC</b> Irwindale Recreation Center	<b>SDMS</b> San Dimas Retirement Center
<b>CMRNPk</b> Cameron Park Community Center	<b>IRWN</b> Irwindale Senior Citizens Center	<b>SD</b> San Dimas Senior/Community Center
<b>CCHCH</b> Casa Colina	<b>LEES</b> Lark Ellen Elementary School	<b>SDSR</b> San Dimas Recreation Center
<b>COUN</b> Country View Retirement Home	<b>LPSC</b> La Puente Senior Center	<b>SOP</b> Shadow Oak Park
<b>COV-AT</b> Atria - Covina	<b>LV</b> La Verne Community Center	<b>PLUM</b> Stanley Plummer Building
<b>DBC</b> Diamond Bar Center	<b>MAS</b> The Masonic Home	<b>VILA</b> Villa Colina
<b>EMSD</b> Emeritus of San Dimas	<b>MSAG</b> Mt. San Antonio Gardens	<b>WALT</b> Walnut Senior Center
<b>ESEALS</b> Easter Seals	<b>PSC</b> Palomares Senior Center	<b>WPK</b> Washington Park
<b>ESGVJC</b> E. San Gabriel Val. Japanese Community Center	<b>PATH</b> Pathfinder Park Community Center	<b>WCSCC</b> West Covina Senior Citizens Center
<b>GPP</b> Ganesha Park Pool	<b>RAN</b> Atria - Rancho Park Adult Community	<b>WPCC</b> Westmont Park Community Center
<b>HERI</b> Heritage Park Community Center	<b>RGNT</b> Regent Senior Living	<b>WSSC</b> William Steinmetz Senior Center
<b>HILL</b> Hillcrest Homes	<b>RIOVER</b> Rio Verde Academy	

**OAD MOX02**

**Healthy Aging - Principles of Slow Movement**

Healthy aging, including diet, nutrition, disease prevention, and application of Tai Chi principles to maintain health while aging for the older adult population.

11174	MW	9:00am - 9:50am	Rafter, J	IRWN
11172	Th	9:00am - 10:50am	Rafter, J	DBC

**NOTE:** Diamond Bar Center: Healthy Aging Principles of Slow Movement- 5/24/15 at 10:00 am. (Thursday). Registration cards will be handed out. 30 completed registration cards will be randomly drawn. Each person must be present during the registration process and may only register for him or herself. Students may not register for another student at this time. Students may register for only one Healthy Aging Principles of Slow Movement class.

11177	F	9:00am - 10:50am	Rafter, J	PLUM
11175	MW	10:00am - 10:50am	Rafter, J	IRWN
11179	M	1:00pm - 2:50pm	Rafter, J	WCSCC
11176	Th	1:00pm - 2:50pm	Rafter, J	LV
11178	T	2:00pm - 3:50pm	Rafter, J	WALT

**NOTE:** Walnut Senior Center: General Registration Date for the Following Classes: 5/14/18 from 10:00-11:00 a.m. (Monday) Note this is for classes held at Walnut Senior Center only. Oil Painting, Home Gardening, Beginning Decorative Art Production for Retail Sales, Healthy Aging Principles of Slow Movement, and all Computer Classes including Digital Photography. Each person must register for himself/herself. Students may not register for anyone else.

**OAD MOX04**

**Healthy Aging - Principles of Posture and Flexibility**

Healthy aging, including diet, nutrition, disease prevention, and application of Yoga principles to maintaining health while aging for the older adult population.

11180	TTh	7:30am - 8:35am	Bresciani, A	HERI
11192	Th	8:15am - 9:05am	Overoye, S	WCSCC
11182	MWF	8:30am - 9:50am	Klein, G	PATH

**NOTE:** Pathfinder Park Community Center: Healthy Aging - Principles of Posture and Flexibility- 5/25/18 at 9:00 am. (Friday). Registration cards will be handed out. 70 completed registration cards will be randomly drawn for class. Each person must be present during the registration process and may only register for him or herself. Students may not register for another student at this time.

11186	T	9:00am - 9:50am	Tamburro, M	SD
11187	Th	9:00am - 10:20am	Tamburro, M	SD
11189	Th	10:00am - 11:20am	Trimble, J	LEES
11191	T	10:15am - 11:05am	Trimble, J	WCSCC
11185	T	11:00am - 11:50am	Tamburro, M	PSC
11188	F	11:00am - 11:50am	STAFF	IRWN
11183	MWF	12:30pm - 1:50pm	Klein, G	SOP
11190	T	8:30am - 10:00am	Trimble, J	WALT
11184	M	3:30pm - 5:00pm	Klein, G	WALT

**NOTE:** Walnut Senior Center: Healthy Aging Principles of Posture and Flexibility- 5/22/18 at 8:30am. (Tuesday Jill Trimble). Registration cards will be handed out. 70 completed registration cards will be randomly drawn for each class. Each person must be present during the registration process and may only register for him or herself. Students may not register for another student at this time. Students may register for only one Healthy Aging Class.

11181	Th	4:30pm - 6:00pm	Klein, G	DBC
-------	----	-----------------	----------	-----

**OAD MOX06**

**Healthy Aging - Principles of Aquatic Resistance**

Healthy aging, including diet, nutrition, disease prevention, and application of aquatic resistance principles to maintaining health while aging for the older adult population.

11193	MTWThF	8:45am - 9:35am	Friedman, K	MAS
11197	TWThF	9:00am - 9:50am	Castro, C	GPP
11194	MTWThF	9:45am - 10:35am	Friedman, K	MAS
11195	MTWTh	4:30pm - 5:20pm	Ledezma, E	IRC

**LOCATION CODES FOR OLDER ADULT PROGRAM**

<b>BRDG</b> Bridgecreek Retirement Center	<b>IRC</b> Irwindale Recreation Center	<b>SDMS</b> San Dimas Retirement Center
<b>CMRNPk</b> Cameron Park Community Center	<b>IRWN</b> Irwindale Senior Citizens Center	<b>SD</b> San Dimas Senior/Community Center
<b>CCHCH</b> Casa Colina	<b>LEES</b> Lark Ellen Elementary School	<b>SDSR</b> San Dimas Recreation Center
<b>COUN</b> Country View Retirement Home	<b>LPSC</b> La Puente Senior Center	<b>SOP</b> Shadow Oak Park
<b>COV-AT</b> Atria - Covina	<b>LV</b> La Verne Community Center	<b>PLUM</b> Stanley Plummer Building
<b>DBC</b> Diamond Bar Center	<b>MAS</b> The Masonic Home	<b>VILA</b> Villa Colima
<b>EMSD</b> Emeritus of San Dimas	<b>MSAG</b> Mt. San Antonio Gardens	<b>WALT</b> Walnut Senior Center
<b>ESEALS</b> Easter Seals	<b>PSC</b> Palomares Senior Center	<b>WPK</b> Washington Park
<b>ESGVJC</b> E. San Gabriel Val. Japanese Community Center	<b>PATH</b> Pathfinder Park Community Center	<b>WCSCC</b> West Covina Senior Citizens Center
<b>GPP</b> Ganesha Park Pool	<b>RAN</b> Atria - Rancho Park Adult Community	<b>WPCC</b> Westmont Park Community Center
<b>HERI</b> Heritage Park Community Center	<b>RGNT</b> Regent Senior Living	<b>WSSC</b> William Steinmetz Senior Center
<b>HILL</b> Hillcrest Homes	<b>RIOVER</b> Rio Verde Academy	

**OAD MOX11**

**Healthy Aging: Fall Prevention, Balance and Mobility**

Risks and fears associated with falling for older adults. Includes setting realistic goals, minimizing environmental risks, and balance exercises.

11200 MF 10:15am - 11:05am Klein, G WALT

**NOTE:** Walnut Senior Center: • Fall Prevention Balance and Mobility registration- 5/25/18 at 10:15 a.m. (Friday). Registration cards will be handed out. 70 completed registration cards will be randomly drawn for each class. Each person must be present during the registration process and may only register for him or herself. Students may not register for another student at this time. Students may register for only one Healthy Aging Class.

11201 T	11:00am - 11:50am	Bresciani, A	IRWN
11198 Th	11:00am - 12:05pm	James, D	PSC
11202 Th	11:30am - 12:20pm	Trimble, J	LEES
11199 TTh	1:00pm - 1:50pm	Klein, G	SOP
11203 TTh	1:30pm - 2:20pm	Trimble, J	LV

**LIFELONG LEARNING**

**DSPS IAEP**

**Interacting with Emergency Personnel and Authorities**

Prepares students with disabilities to interact with emergency personnel including law enforcement. Overview of the criminal justice system and reporting victimization.

11118 M	8:45am - 11:35am	Cardona, Y	CCHCH
11120 M	8:45am - 11:35am	Lee, Z	CCHCH
11119 M	8:55am - 12:00pm	Espinoza Rodriguez, L	RIOVER
11121 M	8:55am - 12:00pm	Ramirez Catalan, B	LV
11125 T	8:55am - 12:00pm	Ramirez Catalan, B	WPCC

**DSPS ELL01**

**Lifelong Learning for the Special Needs Population**

Educational activities for special needs students emphasizing physical, cognitive, social, and emotional skill development.

10840 TTh	8:45am - 11:35am	Cena, A	CCHCH
10843 TThF	8:45am - 11:35am	Lee, Z	CCHCH
10836 F	8:45am - 11:35am	Cardona, Y	CCHCH
10842 TWTThF	8:55am - 12:00pm	Espinoza Rodriguez, L	RIOVER
10844 WF	8:55am - 12:00pm	Ramirez Catalan, B	LV
10845 Th	8:55am - 12:00pm	Ramirez Catalan, B	WPCC
10838 Th	10:30am - 11:55am	Cardona, Y	PLUM
10837 MF	1:00pm - 1:50pm	Cardona, Y	CCHCH
10841 T	1:00pm - 1:50pm	Cena, A	CCHCH
10846 TTh	1:00pm - 3:50pm	Ramirez Catalan, B	40-119
10839 Th	1:00pm - 1:50pm	Cena, A	CCHCH

**OAD ELL04**

**Lifelong Learning for Older Adults**

Improve or maintain mental fitness of older adults through educational activities promoting critical thinking and cognitive skills.

**NOTE:** Please refer to the college website for more detailed information on course offerings.

## Locations of Off-Campus Classes

### **Atria Covina**

825 W. San Bernardino Rd.  
Covina, CA 91722  
Phone: (626) 967-9621

### **Atria Rancho Park**

801 Cypress Way  
San Dimas, CA 91773  
Phone: (909) 592-9662

### **Bridgecreek Retirement Center**

3601 Holt Ave.  
West Covina, CA 91791  
Phone: (626) 332-1135

### **Cameron Park Community Center**

1305 E. Cameron Avenue  
West Covina, CA 91791  
Phone: (626) 919-6966

### **Casa Colina Hospital and Centers for Healthcare,**

255 East Bonita Avenue,  
Pomona, California  
Phone: (909) 596-7733 X 4413

### **Country View Retirement**

824 Cameron Ave.  
West Covina, CA 91790  
Phone: (626) 962-3511

### **Diamond Bar Center**

1600 S. Grand Ave.  
Diamond Bar, CA 91765  
Personal Line: (909) 839-7068  
Phone: (909) 839-7070

### **East San Gabriel Valley Japanese Community Center**

1203 W Puente Avenue  
West Covina, CA 91790  
Phone: (626) 960-2566

### **Brookdale of San Dimas**

1740 S. San Dimas Ave.  
San Dimas, CA 91773  
Phone: (909) 544-4869

### **Ganesha Park Pool**

1575 N. White Avenue  
Pomona, CA 91768  
Phone: (909) 620-2329

### **Heritage Park Community Center**

2900 Brea Canyon Rd.  
Diamond Bar, CA 91765  
Phone: (909) 396-5699

### **Hillcrest Homes**

2705 Mountain View Dr  
La Verne, CA 91750  
Phone: (909) 392-4358

### **Irwindale Recreation Center**

16053 Calle de Paseo  
Irwindale, CA 91706  
Phone: (626) 430-2227  
Front desk: (626) 430-2224

### **Irwindale Senior Citizens Center**

16116 Arrow Hwy.  
Irwindale, CA 91706  
Personal Line: (626) 430-2286  
Phone: (626) 430-2284

### **Joslyn Senior Citizen's Center**

Valleydale Park  
815 N. Barranca  
Covina, CA 91723  
Phone: (626) 384-5380  
(626) 858-7271

### **La Puente Senior Center**

16001 Main Street  
La Puente, CA 91744  
Phone: (626) 855-1585

### **La Verne Community Center**

3680 D Street  
La Verne, CA 91750  
Phone: (909) 596-8776  
Romero: (909) 596-8724

### **Lark Ellen Elementary School**

4555 N Lark Ellen Avenue  
Covina, CA 91722  
Phone: (626) 974-4500

### **The Masonic Home**

1650 Old Badillo St.  
Covina, CA 91724  
Front Desk (626) 251-2200

### **Mt. San Antonio Gardens**

900 E. Harrison Ave.  
Pomona, CA 91767  
Phone: (909) 624-5061

### **Palomares Senior Center**

499 East Arrow Highway  
Pomona, CA 91767  
Phone: (909) 620-2324

## Locations of Off-Campus Classes

### **Pathfinder Park Community Center**

18150 Pathfinder Rd.  
Rowland Heights, CA 91748  
Phone: (562) 691-1624

### **Regent Assisted Living**

150 S. Grand Ave.  
West Covina, CA 91791  
Phone: (626) 332-3344

### **Renacimiento Community Center**

2383 Chanslor St.  
Pomona, CA 91766

### **Rio Verde Academy**

2226 E. Rio Verde Drive  
West Covina, CA 91791  
Phone: (909) 274-4220

### **San Dimas Retirement Center**

834 W. Arrow Hwy.  
San Dimas, CA 91773  
Phone: (909) 599-4512

### **San Dimas Senior/Community Center**

201 E. Bonita Ave.  
San Dimas, CA 91773  
Phone: (909) 394-6293

### **San Dimas Recreation Center**

990 W. Covina Blvd.  
San Dimas, CA 91773  
Phone: (909) 592-1430

### **Shadow Oak Park Community Center**

2121 Shadow Oak Drive.  
West Covina, CA 91792  
Phone: (626) 965-0328

### **Stanley Plummer Building**

245 E. Bonita Ave.  
San Dimas, CA 91773  
Phone: (909) 394-6290

### **Villa Colima**

19850 Colima  
Walnut, CA 91789  
Phone: (909) 595-5030

### **Walnut Senior Center**

21215 La Puente Rd.  
Walnut, CA 91789  
Phone: (909) 598-6200

### **Washington Park**

865 E. Grand Avenue  
Pomona, CA 91766  
Phone: (909) 620-2305

### **West Covina Senior Citizens Center**

2501 E. Cortez St.  
West Covina, CA 91791  
Phone: (626) 939-8864  
Front desk (626) 331-5366

### **Westmont Park Community Center**

1808 West 9th Street  
Pomona, CA 91766  
Phone: (909) 620-2329

### **William Steinmetz Senior Center**

1545 South Stimson Avenue  
Hacienda Heights, CA 91745  
Phone: (626) 934-7041

# School of Continuing Education Program Index

## A

A+ Certification Preparation .....	91
Acute CNA .....	93
Administration of Justice .....	91
Adult Basic Education Center .....	87
Adult Basic Skills Lab .....	87
ASVAB Preparation.....	87

## B

Basic Electric Arc Welding .....	92
----------------------------------	----

## C

Campus Map .....	102-103
CNA (Certified Nursing Assistant) .....	93
CNA Orientation .....	94
Computer and Networking Technology.....	91
Computing (Levels 1,2,3) .....	95

## D

Decorative Art Production for Retail Sales.....	96
Digital Photography for the Beginner.....	95
Drawing (Beginning – Advanced) .....	95

## E

Education for Older Adults .....	94-98
English as a Second Language (ESL).....	92-93

## F

Farm Tours (Ad).....	86
----------------------	----

## G

GED Exam Preparation /Testing .....	87
-------------------------------------	----

## H

Health Care/ Careers .....	93-94
Health Careers Resource Center .....	93
Healthy Aging (Older Adults) .....	96
Healthy Aging (Principles of Aquatic Resistance) .....	97
Healthy Aging (Principles of Posture and Flexibility).....	97
Healthy Aging (Principles of Slow Movement).....	97
High School Referral Program .....	87
High School Diploma Program for Adults.....	87
Home Gardening.....	95
Home Health Aide .....	93

## I

In-Home Support Services.....	93
Internet Research.....	95

## J

Jewelry Production & Design for Retail Sales.....	96
---	----

## L

Language Learning Center (LLC).....	93
Learning Assistance Center & Lab .....	88
Lifelong Learning.....	98

## N

Needlework for Retail Sales .....	96
-----------------------------------	----

## O

Off-Campus Class Locations .....	99-100
Oil Painting .....	95

## P

Parking Information .....	102-103
Photography .....	91
Photography, Basic and Film.....	91
Physical Therapist Aide .....	93

## R

Registration Process.....	85-86
---------------------------	-------

## S

SAT Preparation .....	87
Short-Term Vocational .....	91-92
Students with Disabilities Program & Services .....	92

## T

TOEFL.....	93
Tutoring .....	88

## V

Vocational English as a Second Language (VESL).....	93
---	----

## W

Welding, Introduction to.....	92
Welding Metallurgy .....	92
Wildlife Sanctuary (Ad) .....	86
Writing Center .....	89

# Legend for Campus Map

Location Building Number + (Grid)

## A

Academic Senate	4 (F,2)
Accessible Technology Center (DSPS)	9E (D,2)
ACES	9E (D,2)
Adult Basic Education Center	30 (B,4)
Admissions & Records	9B (D,2)
Administration	4 (F,2)
Agricultural Sciences	80 (C,5)
Animation Drawing Lab	13 (D,3)
Art Center	1A/B/C (D,1)
Art Computer Graphics Lab	13 (D,3)
Art Gallery/Classrooms	1B/C (D,1)
Arts Division Office	12 (D,3)
ARISE (Asian American Pacific Islander Program)	16B (E,3)
ASPIRE	9D (D,2)
Assessment	9B (D,2)
Athletics Modular	44 (G,4)
Auxiliary Services	9A (D,2)

## B

Biological Services	7 (F,3), 11 (E,2), 60 (E,3) & 61 (E,2)
Bookstore (SacBookRac) Photo ID	9A (D,2)
Box Office	2T (E,1)
Bursar's Office/Permits	4 (F,2)
Business Division Office	77 (D,3/4)
Business Faculty Offices	77,78,79(D,3/4)
Business and Computer Technology	77,78,79(D,3/4)
Bridge/Learning Communities	9E (D,2)

## C

Campus Events	6 (E,2)
Campus Police (Public Safety)	23 (F,5)
Career & Transfer Services	9B (D,2)
Center for Deaf and Hard of Hearing Services (DHH)	9A (D,2)
Center of Excellence	21D (E,3)
Central Plant	29 (D,4)
Central Plant Office	29B (D,4)
Chemistry Department	7 (F,3)
Child Development Administration	70 (C,4)
Child Development Classes	73 (C,4)
Child Development Complex	70-73 (C,4)
Child Development Faculty Offices	73 (C,4)
Clarke Theater	2T (E,1)
Communication Department	26D (E,3)
Computer Technology	77,78,79(D,3/4)
School of Continuing Education Division Office	40 (C,5)
Counseling Department	9B (D,2)

## D

Dance Studio	2T (E,1)
Design Technology	13 (D,3)
Disabled Student Programs & Services	9B (D,2)
Document Storage/Facilities Planning	46A (F,5)
DREAM	16C (E,3)

## E

English Department Office	26D (E,3)
EOPS/CARE/CalWORKs	9B (D,2)
Emergency Operations Center/ Facilities Construction Offices	46 (F,5)
ESL Classrooms	31A & B, 32, 35-36 (B,4) & 66 (D,4)
Exercise Science/Wellness Center	27A (E,4)
Express Stop (Food & Supplies)	16A (E,3)

## F

Facilities, Planning + Management / Maintenance + Operations	47 (F/G,5)
Farm (Agriculture/Horticulture/VetTech)	
48th District Agricultural Association	F10 (D,5)
Agricultural Sciences	80 (C,5)

Equine Unit	F6A-B-C (D,6)
Equipment Barn	F3 (C,5)
Equipment Technology	F7 (D,5)
Farm Offices	F2A (C,5)
Horticulture Storage	F2B (C,5)
Horticulture Unit	F1 (B,5)
Irrigation & Landscape Construction	F2C (C,5)
Livestock Pavilion	F9 (C,5)
Small Animal Care Unit	F5B (C,6)
Swine Unit	F4A & F4B (B/C,6)
Vivarium	F5A (C,6)
Fashion	13 (D,3)
Feddersen Recital Hall	2M (E,1)
Field House	50G (F,6)
Financial Aid	9B (D,2)
Fiscal Services	4 (F,2)
Foreign Languages	66 (D,4)
Forensics	26D (E,3)
Foundation Office	12 (D,3)
Founders Hall	10 (E,2)

## G

Grants	4 (F,2)
Gym	3 (E,2)

## H

Health Careers Center	67A & B (D,4)
Health Careers Resource Center	67B (D,4)
Heating/Air Conditioning	69 (E,4)
High School Outreach	9B (D,2)
High School Referral/ Adult Diploma Programs	32, 33 & 38A-B (B,4)
History/Geography/ Political Science	26D (E,3)
Honors Program	26A (D,3)
Hospitality & Restaurant Management	19B (E,3)
Human Resources	4 (F,2)
Humanities & Social Sciences Division Office	66 (D,4)
Humanities/Social Sciences	26A, B & D (D/E,3)

## I

Information Technology	23 & 23A (F,5)
Instruction Office	4 (F,2)
Interior Design	13 (D,3)

## J

Journalism	26D (E,3)
------------	-----------

## K

KSAK Radio	6 (E,2)
Kinesiology, Athletics & Dance	45 (F,4)
Kinesiology, Athletics & Dance Division Office	45 (F,4)

## L

Language Center	66 (D,4)
Library / Learning Technology Center	6 (E,2)
Library & Learning Resources Division Office 6	(E,2)
Locker Rooms	27C (E,4)

## M

Mail Center	4 (F,2)
Maintenance & Operations/Facilities Planning & Management	47 (F/G,5)
Marketing & Communication	4 (F,2)
Math & Science	61 (E,2)
Math Tutoring	61 (E,2)
Media Services	6 (E,2)
Mental Health Faculty Offices	67A (D,4)
Mountie Café (Food)	8 (D,2)
Mountie Grill - WOW (Food)	19C (E,3)
Music/Dance/Theater Classes	2M & 2T (E,1)

## N

Natural Sciences Division Office	61 (E,2)
----------------------------------	----------

Natural Sciences Complex 7	(F,3), 11 (E,2), 60 (E,3) & 61 (E,2)
Nutrition	19B (E,3)

## O

Older Adult Programs	36 (B,4)
----------------------	----------

## P

Parking Office (Violations)	23 (F,5)
Payroll & Purchasing	4 (F,2)
Performing Arts Center	2M & 2T (E,1)
Photographics	13 (D,3)
Planetarium	26C (D,3)
Pool	27P (E,4)
President's Office/Board Room	10(E,2)
Printing Services	4 (F,2)
Professional & Organizational Development	6 (E,2)
Prime Stop (Food & Supplies)	61 (E,2)
Public Affairs & Media Relations	4 (F,2)
Public Safety	23 (F,5)

## R

REACH	9B (D,2)
Receiving/Transportation	48 (G,5)
Regional Health Occupations Resource Center (RHORC)	35 (B,4)
Research & Institutional Effectiveness	4 (F,2)
Risk Management	4 (F,2)

## S

School of Continuing Education Division Office	40 (C,5)
Science Laboratories	60 (E,3)
Science - North	11 (E,2)
Science - South	7 (F,2/3)
Sherman Park	F1A (C,4)
Short Stop (Food & Supplies)	67A (D,4)
Starbucks	8 (D,2)
Student Health	67B (D,4)
Student Health (Satellite Office)	9E (D,2)
Student Life Center	9C (D/E,2)
Student Services Center	9B (D,2)
Student Services Annex	9D (D,2)
Student Success Center	9E (D,2)
Studio Theater	2T (E,1)

## T

Teacher Preparation Institute	26A (D,3)
Technology Center	28A/B (E,3/4)
Technology & Health Division Office	28A (E,3)
Technical Education Resource Ctr (TERC)	18C (E,3)
Technical Services	6 (E,2)
Telecommunications	23 (F,5)
Tutorial Services/ Supervised Tutoring (LAC)	6 (E,2)
TV Production/Broadcasting	6 (E,2)

## U

Upward Bound	9B (D,2)
--------------	----------

## V

Veterans Resource Center	9E (D,2)
Vocational Technical Ed. Act (VTEA)	40 (C/D,5)

## W

Welding/Air Conditioning	69 (E,4)
Wellness Center	27A (E,3/4)
WIN (Student Athlete Tutorial Center)	45 (F/G,4)
Writing Center	26B (D,3)

# Mt. San Antonio College

1100 N. Grand Ave. Walnut, CA 91789

Phone: (909) 274-7500 | Campus Police: (909) 274-4555 | Text-A-Tip: (909) 610-9139

Interactive Campus Map: [www.mtsac.edu/maps](http://www.mtsac.edu/maps)

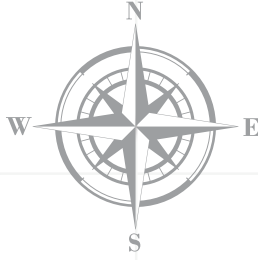

Updated: 2018-02-22

EMERGENCY BLUE PHONE (909) 274-4555	STUDENT PARKING LOT	EMPLOYEE PARKING LOT	DAY USE PARKING LOT	DAY USE PERMIT DISPENSER	SHORT-TERM TIMED PARKING	METERED PARKING	INFORMATION KIOSK	PUBLIC TRANSIT STOP	ACCESSIBLE PARKING	ACCESSIBLE VAN SERVICE	SMOKING ZONE	SECURITY ESCORT Mon. - Thurs. 6:30 pm - 10:15 pm

# BUSINESS & COMPUTER TECHNOLOGY COMPLEX

## BUILDINGS 77, 78 & 79



Welcome to Mt. SAC's latest addition, the BCT Complex. It's comprised of three buildings providing about 106,000 square feet of space for classrooms, hands-on labs and state-of-the-art technology.



## Building 79

### 2<sup>ND</sup> FLOOR >

- CIS Faculty Offices**  
(Computer Information Systems)
- CHLD** – Child Development
- CIS** – Computer Information Systems

### 3<sup>RD</sup> FLOOR >

- Accounting & Management Faculty Offices**
- BUSA** – Business Accounting
- BUSM** – Business Management
- BUSS** – Business Sales, Merchandising & Marketing

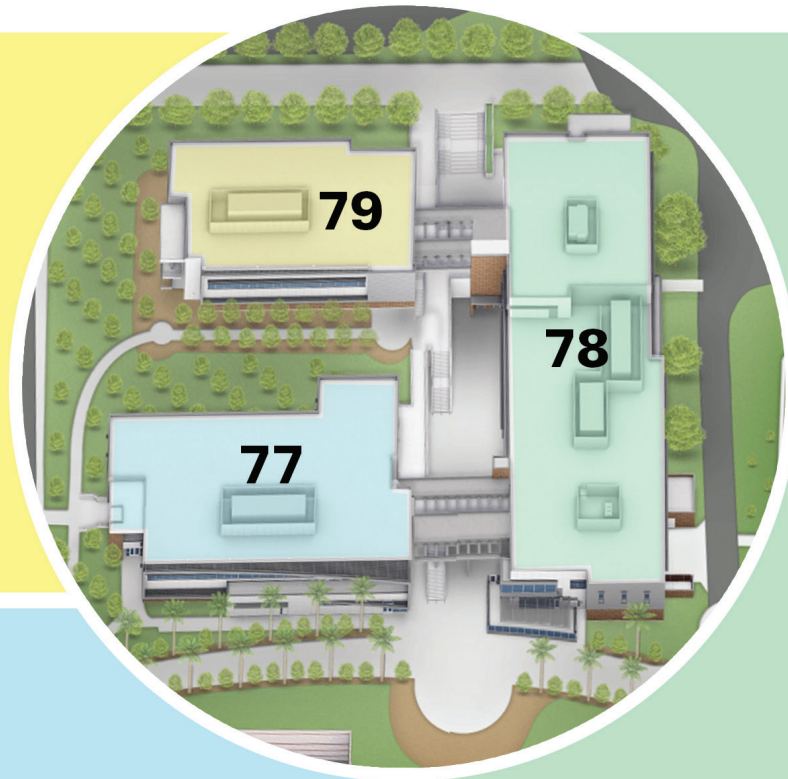

## Building 77

### 1<sup>ST</sup> FLOOR >

- Humanities**
- Language Learning Center**
- Lecture Hall**

### 2<sup>ND</sup> FLOOR >

- Business Division Offices**
- Business Division Project Offices**
- Business Division Computer Lab**

## Building 78

### 1<sup>ST</sup> FLOOR >

- CSDT Faculty Offices**  
(Consumer Sciences & Design Technologies)
- HRM** – Hospitality and Restaurant Management
- NF** – Nutrition and Food
- RESTAURANT**

### 2<sup>ND</sup> FLOOR >

- CISN Faculty Offices**  
(Computer Information Systems: Networking)
- CIS** – Computer Information Systems
- FASH** – Fashion Merchandising and Design

### 3<sup>RD</sup> FLOOR >

- Business Administration Faculty Offices**
- BUSC** – Business Economics
- BUSR** – Business Real Estate
- BUSL** – Business Law
- PLGL** – Paralegal