

Registration
Begins
January 17

Classes
Begin
February 26

School of
Continuing Ed.
Pg. **186**

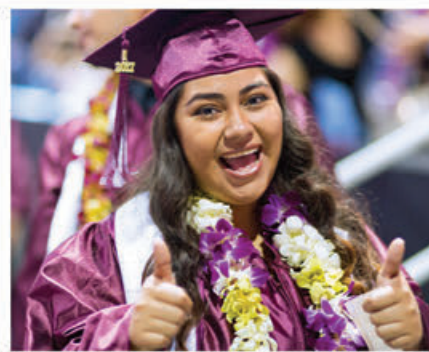

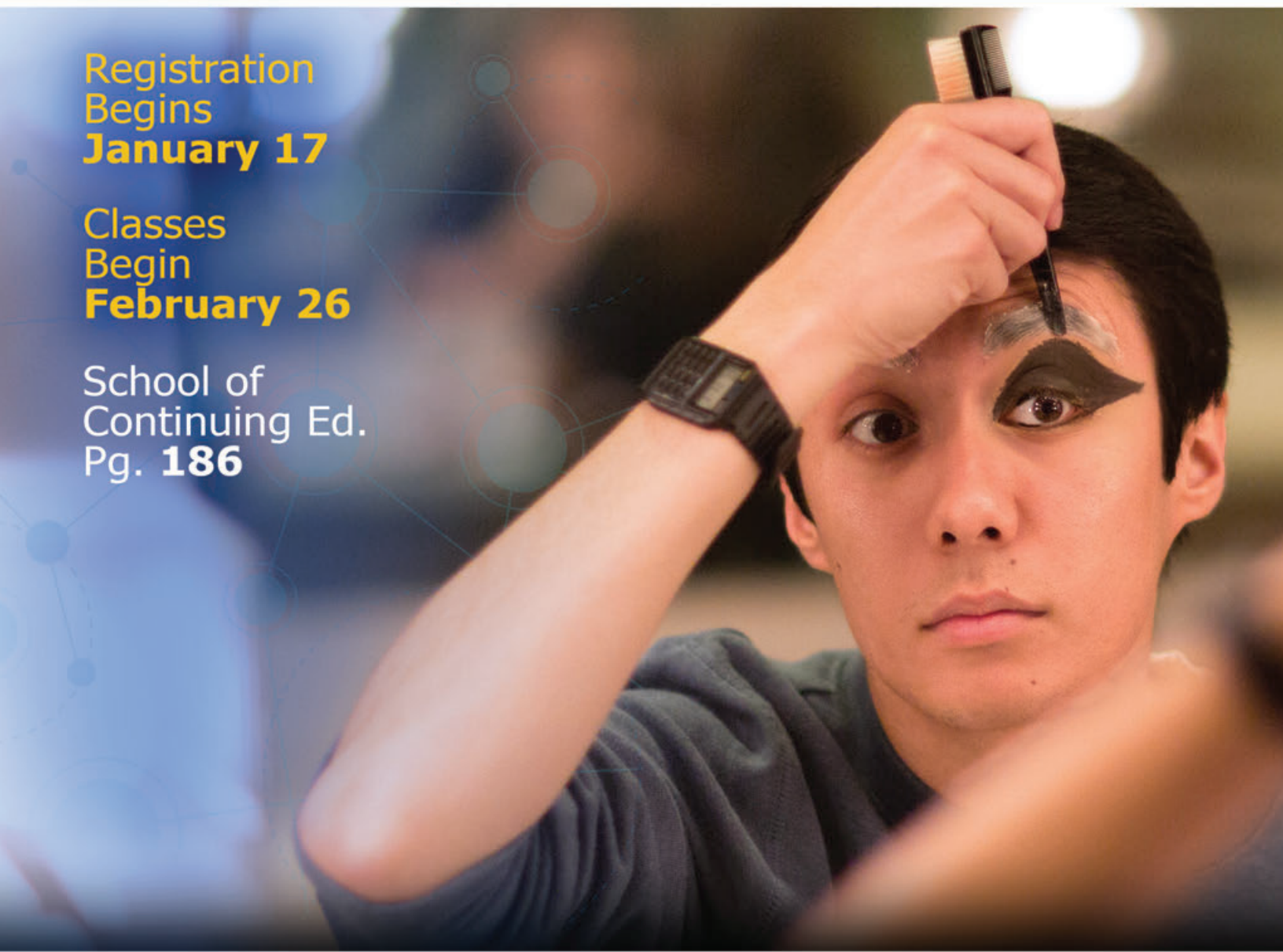

Need help with **tough assignments?**

ONLINE TUTORING
is available evenings
and Sundays.

For more info and
specific service hours, visit:

[http://www.mtsac.edu
/lac/onlinetutoring](http://www.mtsac.edu/lac/onlinetutoring)



ONLINE TUTORING
A service provided by the MT. SAC
Learning Assistance Center

NO SMOKING

Except in Designated Areas



For more information about our
smoking policy and designated areas, visit:

<http://smoking.mtsac.edu>



Board of TRUSTEES

Dr. Manuel Baca
Rosanne M. Bader
Jay Chen
Judy Chen Haggerty, Esq.
Dr. David K. Hall
Robert F. Hidalgo
Laura Santos
Corey Case, Student Trustee

Dr. William T. Scroggins
College President & CEO

Our MISSION

The mission of Mt. San Antonio College is to support all students in achieving their educational goals in an environment of academic excellence. Specifically, the College is committed to providing quality education, services, and workforce training so that students become productive members of a diverse, sustainable, global society. The College pledges to prepare students for lifelong learning through the mastery of basic skills, the achievement of associate degrees and certificates, and the completion of career and transfer pathways. The College will carry out this commitment by providing an engaging and supportive teaching and learning environment for students of diverse origins, experiences, needs, abilities, and goals. The College is dedicated to serving our community through improving economic achievement, advancing civic engagement, enhancing personal well-being, promoting critical thinking, and enriching aesthetic and cultural experiences.

Stay *connected* with Mt. SAC through **Social Media**

search: mtsac



Go to **www.mtsac.edu**
and scroll to the bottom of
the page to download the

mountie app



Joe
Mountie

HOW TO REGISTER . . .

for Credit classes, pages 6-7

School of Continuing Education,
pages 187-189

FINANCIAL AID page 9

CREDIT CLASSES page 31

**SCHOOL OF CONTINUING
EDUCATION CLASSES** page 186

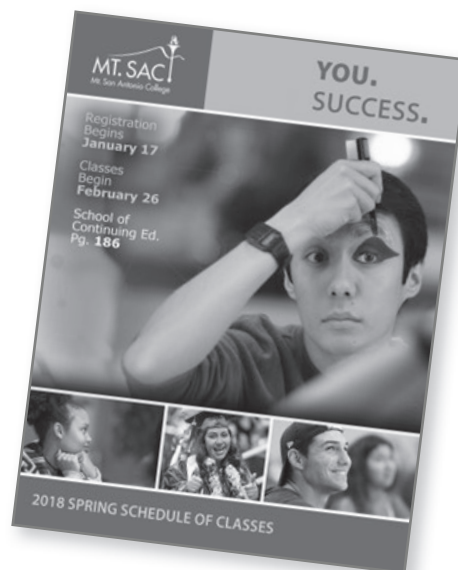

KEY DATES FOR SPRING 2018

January 17	Registration begins for 2018 Spring Semester Credit and Continuing Education classes
February 16	Lincoln's Birthday Holiday (<i>campus closed</i>)
February 18	2018 Winter Intersession ends
February 19	Washington's Birthday Holiday (<i>campus closed</i>)
February 25	Residency determination date for Spring 2018
February 26	2018 Spring Semester begins
March 5	International student application due for 2018 Summer Intersession
March 9	Last day to change residency for Spring
March 12	Last day to return 2018 Spring parking permit
March 30	Cesar Chavez Holiday (<i>campus closed</i>)
May 9	Registration begins for 2018 Summer Intersession Credit and Continuing Education classes
May 12	Last day to petition for 2018 Spring Commencement
May 28	Memorial Day Holiday (<i>campus closed</i>)
June 11 - 17	Final Exams
June 17	Commencement
June 17	2018 Spring Semester ends
June 21	2018 Summer Intersession begins

The last day for withdrawal or for a refund is specific to the course and is listed on the Student Schedule/Receipt.

ALTERNATE FORMATS

The Schedule of Classes is available online at www.mtsac.edu and in alternate formats (Braille, enlarged text, e-text, etc.) upon request. Please contact **Accessibility Resource Centers for Students (formerly known as DSPS)** at (909) 274-4290.

DROP-FOR-NONPAYMENT POLICY

Students are reminded that **payment for all fees is due upon registration**. Students who fail to pay for their classes by the **established deadlines may be dropped**. The deadlines for paying of fees are **Thursday, February 15, 2018** (for classes registered January 17 through February 15 at 8 p.m.) and **Friday, February 23, 2018** (for classes registered February 16 through February 23, 2018). These deadlines will be posted on the student portal at my.mtsac.edu and on the student **Schedule/Receipt**. Fee payment can be made either online any time (except from 11 p.m. to 1 a.m.) or in person at the Bursar's Office (Building 4) during regular business hours.

Contents

ADD Authorization Codes	20	Financial Aid & Scholarships	9
Attendance, Drop & Withdrawal Policies	20	Grades	22
Calendar & Deadlines	4	How To Add Yourself to a Wait List.....	12-13
California Community College Board of Governors		Key Dates.....	4
Fee Waiver (BOGW) Information	8-9	Online Registration.....	10-11
Campus Directory	5	Parking	
Campus Map	210-211	Fees.....	7
Campus Safety	29-30	Policies.....	8-9
Changing Your Class Schedule	20	Purchasing a Parking Permit.....	8
Childcare Services	25	Placement Test Information.....	19-20
Course Policies.....	21	Police & Campus Safety Escort Service.....	29
Credit Classes.....	31	Prerequisites, Corequisites & Advisories.....	18
Fees		Registration Process.....	6-7
Fee Payment Options/Policies	7	School of Continuing Education.....	82
Fee Refund Policy	23	Student Services & Resources.....	24-28
List of Fees	7	TouchNet: Authorized Users	16-17
Nonresidents.....	8		
Paying Fees Online	14-15		

Campus Directory

**For assistance, call the Mt. SAC general number at (909) 274-7500.
For direct access to offices, dial (909) 274 + the 4-digit extension.**

Accessibility Resource Centers for Students (formerly known as DSPS).....	ext. 4290	High School Outreach.....	ext. 5906
Admissions & Records	ext. 4415	Instruction Office	ext. 4200
Adult Basic Education	ext. 4845	Instructional Divisions	
Aspire Program.....	ext. 6396	Arts.....	ext. 5200
Assessment Center.....	ext. 4265	Business	ext. 4600
Bridge Program.....	ext. 5392	Humanities & Social Sciences	ext. 4570
Bookstore ("SacBookRac")	ext. 4475	Kinesiology, Athletics & Dance.....	ext. 4630
Bursar's Office.....	ext. 4960	Library & Learning Resources	ext. 5659
California Work Opportunity and Responsibility to Kids (CalWORKS)	ext. 4755	Natural Sciences	ext. 4425
Career and Transfer Services	ext. 4510	Technology & Health	ext. 4750
Child Development Center.....	ext. 4920	Learning Assistance Center	ext. 4300
Continuing Education.....	ext. 4220	Library.....	ext. 4260
Cooperative Agencies Resources for Education (CARE).....	ext. 4500	Lost & Found (Student Life).....	ext. 4525
Counseling Center	ext. 4380	Older Adult Program	ext. 4192
Directions to Campus	ext. 4181	Parking.....	ext. 4233
English as a Second Language (ESL). ext.	5235	Police & Campus Safety	ext. 4555
Extended Opportunity Programs & Services (EOPS).....	ext. 4500	Police & Campus Safety Escort Service.....	ext. 4555
Financial Aid & Scholarships	ext. 4450	Student Life/Student Activities	ext. 4525
Health Center	ext. 4400	TRIO Programs:	
		ACES & Upward Bound.....	ext. 4411
		Veterans Resource Center	ext. 4520

Registration — 8 Easy Steps

REGISTRATION BEGINS FOR 2018 SPRING SEMESTER Wednesday, January 17, 2018

MAIN CAMPUS — (909) 274-7500

- **STEP 1 — Apply to Mt. SAC** (909) 274-4415
The preferred method of application is via the Web at www.mtsac.edu.
- **STEP 2 — Apply for Financial Aid** (909) 274-4450
Apply for financial aid, fee waivers, and grants.
Mountie Fast Track Info Session: Got questions? These Information Sessions were created to answer your questions and assist you in getting started at Mt. SAC! Register online at: <http://www.mtsac.edu/fasttrackinfosessions>
- **STEP 3 — Placement Test Information Sessions** (909) 274-4265
The info sessions will help you prepare for the tests.
- **STEP 4 — Get Assessed** (909) 274-4265
Schedule and take your course placement tests at the Assessment Center.
- **STEP 5 — New Student Orientation** (909) 274-4380
Attend an orientation session. Any student who is new to Mt. SAC MUST attend orientation before registering for classes.
- **STEP 6 — Counseling** (909) 274-4380
Receive counseling/advising and your Mountie Academic Plan (MAP).
- **STEP 7 — Register** inside.mtsac.edu
Register online. If you need help, visit the Student Services Center.
- **STEP 8 — Fees** (909) 274-4960
Pay your fees by credit card online, check by mail, or cash, check or credit card in person at Bursar's Office.

STEP 1 — Apply to Mt. SAC

Who is eligible for Admission?

- A. Any person possessing a high school diploma or its equivalent or is at least 18 years old is eligible for admission to Mt. San Antonio College.
- B. High school juniors and seniors should apply online at www.mtsac.edu. They will also need to submit a Special Admissions Application and meet the stated criteria. Admission is approved on an individual basis.

Special note to parents, Right of Access:

Under Section 49061 of the Education Code, parents of community college students do not have a right of access to their children's student records, regardless of whether the student is under the age of 18. In accordance with this regulation, students' college records will be released to parents only with the written consent of the student.

How Do I Apply?

- A. Apply online by visiting www.mtsac.edu and clicking on the "Apply Now" link.

- B. Students who are new to Mt SAC must apply online for admission. Returning Mt SAC students with an absence of two consecutive semesters (excluding Summer and Winter intersessions) must re-apply online for admission. Students who have attended Mt SAC within the past academic year do not need to re-apply.
- C. Submit official transcripts from all accredited high schools, colleges, and trade schools attended.

STEP 2 — Apply for Financial Aid

Mt. SAC offers a variety of financial aid programs funded by federal and state agencies and private sources, including grants, fee waivers, work-study opportunities, scholarships, and loans. For further information, contact the Financial Aid Office at (909) 274-4450 or visit <http://www.mtsac.edu/financialaid>

STEP 3 — Placement Test Information Sessions

The sessions will prepare students to take the required placement tests and provide an opportunity for students to ask questions regarding the tests. For further information, contact the Assessment Center at (909) 274-4265 or visit <http://www.mtsac.edu/assessment>

STEP 4 — Get Assessed

Assessment is required of all students attending Mt. SAC. Most classes have basic skills prerequisites that must be assessed prior to registration. Course eligibility may be determined by placement test results or by previous Mt. SAC or other college coursework. Apply online at www.mtsac.edu before taking your placement tests. Assessment must be completed prior to your orientation and registration date and time.

To Make a Placement Test Appointment:

- A. Determine the test(s) required for the courses in which you plan to enroll.
 - Placement Test information, page 19
- B. To make an appointment, you can:
 - go online at www.mtsac.edu/assessment; or
 - call the Assessment Center at (909) 274-4265; or
 - visit the Assessment Center in the Student Services Center
- C. Arrive at the designated testing room 10-15 minutes early on the day of the test.
 - A photo I.D. is required to take all tests and to receive all test results.
 - Tests scores are valid for two years.
 - Students may retest after three months.

Registration — 8 Easy Steps

STEP 5 — New Student Orientation

College counselors lead group orientation sessions for all new students who are enrolling at Mt.SAC, unless otherwise exempted. Students are exempt (but not prohibited) from participating in orientation, counseling and advising if they meet any of the following:

- A. Enroll in community service classes only
- B. Possess an Associate or higher degree from a regionally accredited institution
- C. Attain 60 units or more from a regionally accredited institution
- D. Select and enroll in a general interest class only.

All students must meet course prerequisites. Completion of orientation is required prior to registering for classes. Students may complete orientation in person or online. To schedule an orientation appointment, call (909) 274-4380, visit the Counseling Center in the Student Services Bldg or online at www.mtsac.edu/counseling/orientation.html.

STEP 6 — Counseling

College counselors lead group education planning sessions for new students who are enrolling at Mt. SAC. Students should complete assessment and have test results prior to participating in an education planning workshop. You will develop a first semester education plan.

STEP 7 — Register

- A. View your assigned registration appointment by visiting inside.mtsac.edu. Login using your username and password, then you can view your assigned registration date and time. Students are not able to register before their assigned date and time.
- B. Prior to your registration appointment, review the *Schedule of Classes* and prepare a tentative class schedule. You will need to have the Course Reference Number (CRN) when you register online. Some classes may be closed at your registration time, so be prepared with some alternatives.
- C. You can search for open classes online at www.mtsac.edu/searchforclasses/.
- D. You will be able to add yourself to wait lists for courses during registration.
- E. Check course prerequisites and corequisites. *A prerequisite is a course or experience which must be completed prior to enrollment in certain courses.* Be sure that you have completed the required prerequisites for the courses you have selected. Prerequisites are identified in the course descriptions in the *Schedule of Classes* and in the college Catalog.
- F. Be sure to register for required corequisites. *A corequisite is a course that must be taken during the same term as the course originally chosen.* Corequisites are identified in the course descriptions in the *Schedule of Classes* and in the college Catalog. Some corequisites may have been taken previously.

STEP 8 — Fees

Payment is due upon registration. Students who fail to pay for their classes by the established deadlines may be dropped. Students who remain enrolled after the course refund deadline remain financially responsible for the payment of fees even if they drop the class or are dropped by their instructor. Please check inside.mtsac.edu student portal for further information.

All fees are subject to change.

Fee Explanations

Contact the Bursar's Office at (909) 274-4960 with fee-related questions.

Enrollment Fee: The Enrollment Fee is \$46 per unit. Students who qualify for the Board of Governors Fee Waiver (BOGW) are not required to pay this fee.

Non-Resident and International Student Tuition: Out-of-state tuition fees are \$264 per unit and are re-

FEES (refer to Fee Explanations below)	Fees subject to change	
ENROLLMENT FEE	Resident	\$46 per unit
	International Students	\$310 per unit (\$264 per unit + \$46 per unit enrollment fee)
	Non-Resident Students	\$310 per unit (\$264 per unit + \$46 per unit enrollment fee)
STUDENT HEALTH FEE	Regular	\$20
	With BOGW	\$15
PARKING PERMIT	Regular	\$50
	With BOGW	\$25
STUDENT ACTIVITIES FEE	Collected in Fall and Spring semesters only	\$11
STUDENT REPRESENTATION FEE	Collected in Fall and Spring semesters only	\$0.50
STUDENT TRANSPORTATION FEE	Collected in Fall and Spring semesters only	\$8 part-time students \$9 full-time students

quired of all students who have not established residency in the State of California for a period of one year prior to the day before classes begin. International student tuition fees are \$264 per unit and are required of all non-resident international students attending Mt. SAC on an F-1 Visa. Contact Admissions & Records at (909) 274-4415 with residency questions.

Student Health Fee: Required of all credit students. Students who qualify for the Board of Governors Fee

Fee Payment Options/Policies

Waiver pay a reduced fee. Pursuant to Section 76355 of the Education Code, Mt. SAC has a process by which students may request to waive the health fee. To qualify for a waiver, students must provide documentation of active membership in a religious organization that relies exclusively upon prayer for healing. Applications for waivers are available in the Bursar's Office or in the Student Health Center (67B) for the first two weeks of the semester.

Parking Permit: A valid parking permit is required at all times to park on campus in all student parking lots. Parking permit replacement fees will apply.

Student Activities Fee: This fee is charged during Fall and Spring semesters for the purpose of providing book grants, scholarships, leadership opportunities, co-curricular programs and activities, and discounted amusement park and movie theater tickets. Refunds and waivers of this fee will not be approved after the second week of the semester.

Student Transportation Fee: Effective Summer 2015, a mandatory transportation fee for the Foothill Transit Class Pass Program will be charged to full and part-time students. California Education Code Section 76361 authorizes the governing board to require students to pay a fee for the purposes of partially or fully recovering transportation costs incurred by Mt. SAC.

Student Representation Fee: A mandatory fee that is collected during Fall and Spring Registration for the purpose of providing Mt. SAC students the means to advocate their positions and viewpoints before city, county and state government agencies.

Additional fees paid at the Bursar's Office:

- Material Cards & Field Trip Fees
- Verification Requests
- F-1 Student Application Fee (\$50)

Owing a Debt to the College

Mt. SAC will withhold grades, transcripts, degrees, registration privileges, or any other combination thereof, from any student or former student who has failed to pay a valid financial obligation due to the College (e.g., returned check, unpaid loan, equipment breakage, financial aid overpayment, unpaid registration fee). Any item or items withheld shall be released when the student satisfactorily meets his/her financial obligation. When the outstanding

Parking Permits

Online: After registering for classes, click on Student Portal #31 to order your parking permit through the permit vendor, Credentials Order Processing Services. Enter mailing address, license plate and registration information for each vehicle and provide credit card information. Our third party vendor will mail the permit within approximately 7-10 business days. A temporary permit may be printed to display until it arrives.

In person: Student parking permits can be purchased in person at the Bursar's Office (Building 4, lower level) during business hours. Vehicle license plate and registration information must be provided at the time of purchase. Payment for parking permit accepted by cash or check only.

financial obligation owed to the College is sent to our collection agencies, Chancellor's Office Tax Offset Program, the collection cost incurred will be added to the original amount owed. Returned checks must be paid in the form of cash, credit card, money order or a cashier's check, and a returned check charge of \$25 will be added to the amount of the check.

Fee Payment Options/Policies

- Payment is due upon registration.
- Any unpaid fees after the first day of the semester will result in a financial hold placed on your account. Financial holds will prevent students from enrollment, withdrawals, will prohibit access to transcripts and grades, and will limit access to certain campus services.
- Check your schedule to verify any course adds and/or drops.
- It is the student's responsibility to drop classes by the appropriate deadline as shown on the Student Schedule/Receipt. Students who remain enrolled after the course refund deadline remain financially responsible for payment of fees even if they drop the class or are dropped by their instructor.
- Students who fail to pay for their classes by the established deadlines will be dropped. Please check **inside.mtsac.edu** student portal for established deadlines and further information.

Fee payment may be made online, by mail, or in person.

Online Payments

Following online registration, fees can be paid online using VISA, MasterCard, Discover, American Express or a check card displaying the above logos. The payment link is # 25 on the Mt. Sac Student Portal, StudentTab.

Fee Payment Options/Policies

Mail Payments

Following online registration, fees can be paid by mailing a check or money order payable to Mt. SAC with the student ID number included on the check or money order. Mail to: **Bursar's Office, 1100 N. Grand Ave., Walnut, CA 91789.** DO NOT MAIL CASH.

In-Person Payments

Following online registration, fees can be paid in person at the Bursar's Office in Building 4, Lower Level. The Bursar's office accepts cash, money orders, personal checks, business checks, Rehab vouchers, credit cards and cashier's checks.

Policy for Check Payment

- Checks must be written for exact amount only.
- All checks must be made payable to Mt. SAC (*third party checks are **not** acceptable*).
- Personal checks must have a pre-printed address imprinted on the check (***no** temporary checks*).
- Checks with written amount corrections are not acceptable.
- Post-dated checks are not acceptable.
- Students who have written two previous checks that have been returned for insufficient funds will not be allowed to write another check for

registration.

Policy for Credit Card Payment

- Visa, MasterCard, Discover, and American Express are accepted.
- Mt. SAC does not give cash advances or cash back

WHEN DO I REGISTER?

Check your registration appointment online for your date and time. You may not register prior to the date and time assigned. Register online at ***inside.mtsac.edu*** (6:00 a.m. - 11:00 p.m., Mon. - Sat.). Computers and staff are available for students to register in the Student Services Center.

You may register during the following times		
From	Begin Time To	End Time
Jan 15, 2015	07:00 am	Jun 14, 2015 11:59 pm

<input checked="" type="checkbox"/>	You have no Holds which prevent registration.
<input checked="" type="checkbox"/>	Your Combined Academic Standing is Good Standing which
<input checked="" type="checkbox"/>	Your Student Status permits registration.
	Your Class for registration purposes is Freshman.

Earned Credit		
Level	Type	Hours
Credit	Transfer	0.000
Credit	Institutional	3.000
Non Credit	Institutional	0.000

Curriculum Information	
Current Program	
Associate in Science	
Level:	Credit
Program:	Psychiatric Tech AS Degree
Admit Term:	Winter 2010
Admit Type:	Standard
Catalog Term:	Fall 2013
College:	Mt. San Antonio College
Campus:	Mt. San Antonio College

Financial Aid and Scholarships

Financial Aid

Mt. SAC offers a variety of financial aid programs funded by the federal and state government and private sources, including grants, fee waivers, work-study opportunities, scholarships, and loans. These programs are available to eligible students to help meet the cost of attending college. Students may apply for aid by filing a Free Application for Federal Student Aid (FAFSA) form at ***www.fafsa.gov***.

Eligible for the CA Dream Act? If you meet requirements for an AB 540 nonresident tuition exemption, you could be eligible for state and institutional aid. Apply online: ***https://dream.csac.ca.gov***.

Fee waivers to cover enrollment costs are available through the Board of Governors Fee Waiver (BOGW) program.

Apply online at: ***www.mtsac.edu/students/finaid***.

The Financial Aid Office is located on the upper level of the Students Services Center (9B); our phone number is (909) 274-4450. We have staff and computers available to help you complete financial aid forms.

Scholarships

In addition to federal and state aid, scholarships are available to qualified students based on a number of factors, such as educational goal, major, need and/or merit.

The Mt. SAC Title IV code is: 001245

Students may submit a Mt. SAC Scholarship Program Application during the Spring semester of each year to be considered for over 100 scholarships.*

Visit the Scholarship Program Office (Bldg. 9B) for assistance with researching on and off-campus scholarship opportunities, application assistance, personal essay advisement and monthly workshops/presentations.

Students may walk-in for general information or request an appointment by calling **(909) 274-4457**, or e-mailing ***scholarships@mtsac.edu***. For more info, visit ***www.mtsac.edu/scholarships/***.

Funds are made available to students in the following Fall semester. Scholarship deadlines, eligibility information and applications are available on the Financial Aid tab of the *inside.mtsac.edu*** student portal.*

Online Registration

STEP 1. Log on to: *inside.mtsac.edu*

STEP 2. You will need to enter your **Username** and your **Password** to login.

STEP 3. Once you are in, click on **Student** Tab to display your menu. (B)

STEP 4. Click on **Student Self-Service Links** option No. 4. (C)

STEP 5. Click on **Select a Term.** (D)

STEP 6. Hit submit. (E)

STEP 7. Enter the five-digit **Course Reference Number (CRN)** in the area provided for each course you are trying to add (up to 10 classes at one time). (F)

STEP 8. Click on **Submit Changes** after you have entered all of your numbers. (G)

Secure Login

User Name:

Password:

Login Cancel

Home College Library **Student** Student Success Financial Aid eLearning Tools Noncredit

Personal Announcements

[Spring 2015] Online Services to help you this semester!
Student Parking Available in Lot M
Student Life Weekly Calendar
Earn a free certificate in Leadership!
2014 1098T Form Is Now Available

Campus Announcements

Phase 1 Perimeter Fence - Student Lot A
Step Up: Improve Your Fitness
Bursar's Office closed Friday, March 27, 2015

College Library **Student** Student Success Financial Aid eLearning Tools Noncredit

Personal Announcements

2015] Online Services to help you this semester!
Parking Available in Lot M
Life Weekly Calendar
Free certificate in Leadership!
98T Form Is Now Available

Campus Announcements

Perimeter Fence - Student Lot A
Improve Your Fitness
Office closed Friday, March 27, 2015

Student Self Service

Registration

1. Apply for Admission
2. Review Existing Application
3. Select Term
4. Register (Add or Drop) Classes
5. Change Class Grading Option
6. Week at a Glance
7. Registration Fee Assessment
8. Registration Appointment/Hold
9. Active Registration
10. Registration History
11. Print Your Schedule/Receipt
12. Search for Classes
13. View Your Waitlist

Student Records

14. View Assessment/Placement Test Scores
15. View Holds
16. Final Grades
17. Grade Detail
18. View Unofficial Transcript
19. Request Official Transcript

Personal Information **Student** Financial Aid Employee Mailing Address

Search Go

Registration Term

Select a Term:

Submit

Before attempting to register for a class, check to make sure the class is open (and the wait list is not filled) at the class schedule search (https://prodsb.mtsac.edu/prod/pw_slgsched.p_Search). Mt. SAC's IT Acceptable Use Policy (http://www.mtsac.edu/administration/infosecurity/acceptable_use.html) prohibits intentionally or negligently performing an act that computer or network to the extent that other users may be denied service. Use of scripts or excessive, repeated unsuccessful registration placement of a temporary hold on your account.

To add a class, enter the Course Reference Number in the Add Classes section. To drop a class, use the options available in the Action pull-down list.

Without petitioning, students may enroll in up to 18 units each semester and up to 7 units each summer and winter intersession. Students who have in a given semester with a grade point average of at least 3.0 and have a minimum cumulative grade point average of at least 3.0 may petition for per maximum. Students wishing to exceed the maximum number of units allowed must contact the Counseling Office (X-4380).

MAXIMUM NUMBER OF UNITS ENROLLED		
Term	Good Standing	Probation Standing
Spring/Fall	18	12
Winter/Summer	7	4

Add Classes Worksheet

CRNs

Submit Changes Class Search Reset

Online Registration

STEP 9. The classes you successfully selected will be displayed.

STEP 10. Review your class schedule. (H)

**Mt. San Antonio College
Student Schedule/Receipt
Spring 2015**

H

Your Registration Begins: 15 JAN 2015 at 7:00am

Schedule for 16-MAR-2015

Enrolled Courses										
Crn	Subj	Crse	Title	Crd	Start Date	End Date	Times	Days	Bld	Rm
40973	ENGL	1A	Freshman Composition	4.0	23-FEB-15	14-JUN-15	12:00- 2:05pm	M W	26A	3620
41374	SPAN	1	Elementary Spanish	4.0	23-FEB-15	14-JUN-15	9:00- 1:15pm		F	66 248
41930	BIOL	21	Marine Biology Lab	1.0	23-FEB-15	14-JUN-15	9:45-12:55pm	T		7 1115
42098	KIN	34	Fitness for Living	3.0	23-FEB-15	14-JUN-15	9:45-11:10am	M W		45 1462
43074	BIOL	20	Marine Biology	3.0	23-FEB-15	14-JUN-15	1:15- 2:40pm	T R		11 2312
44211	BS	LANG1	Language Skills Laboratory	0.0	23-FEB-15	14-JUN-15	TBA			6 264

Additional Information							
Crn	Subj	Crse	Instructor	Email	Refund Deadline	Last Day to Drop Without a W	Last Day to Drop With a W
40973	ENGL	1A	Boehner-Staylor, Maya C.	mstaylor@mtsac.edu	06-MAR-15	08-MAR-15	01-MAY-15
41374	SPAN	1	Baler, Pablo F.	pbaler@mtsac.edu	06-MAR-15	08-MAR-15	01-MAY-15
41930	BIOL	21	Schmidt, Sherry E.	sschmidt@mtsac.edu	06-MAR-15	08-MAR-15	01-MAY-15
42098	KIN	34	Sanchez, Juan C.	jsanchez@mtsac.edu	06-MAR-15	08-MAR-15	01-MAY-15
43074	BIOL	20	Bava, Jose	jbava@mtsac.edu	06-MAR-15	08-MAR-15	01-MAY-15
44211	BS	LANG1	Marcy, Peggy C.	pmarcy@mtsac.edu	12-JUN-15	12-JUN-15	12-JUN-15

Account Information			
<p>Any unpaid fees that result after the semester begins will be placed on a financial hold. Financial holds will prevent students from enrollment, transcripts, withdrawals and prohibit access to certain campus services.</p> <p>It is the student's responsibility to drop classes by the appropriate deadline as shown above. Students who remain enrolled after the refund deadline are not eligible for a refund and remain financially responsible for payment of fees even if they drop the class or are dropped by their instructor.</p>			
		Account Summary for	
		Account Balance: \$0.00	
Spring 2015			
Detail Code	Description	Charge	Payment Balance
ENRL	Enrollment	\$690.00	\$0.00
HTHF	Health Fee	\$19.00	\$0.00
SREP	Student Representation Fee	\$0.50	\$0.00
STAF	Student Activity Fee	\$11.00	\$0.00
VSA2	Visa (Web Credit Cards)		\$720.50 \$0.00

Fee Waiver

California Community College Board of Governors Fee Waiver (BOGW)

The Board of Governors Fee Waiver waives the enrollment fee and provides a reduced cost for health and parking fees. Students are responsible for paying any additional fees.

This assistance is available to qualified California residents. There are three methods by which students may qualify:

Method A:

A student is currently a recipient of funds from TANF (Temporary Assistance for Needy Families), SSI (Supplemental Security Income), or GA/GR (General Assistance/ General Relief), or, if a dependent, such funds are the sole source of income for the family.

Students must provide a current copy of their check or an Untaxed Income Verification form, available online at www.mtsac.edu/students/finaid/forms.html

Method B:

Household size and annual family income. Colleges may ask students to provide documentation of income, such as a copy of their Federal Income Tax Return. **Students are required to provide documentation if it is requested.**

Method C:

A student has applied for other state/federal aid and has demonstrated financial need by completing the Free Application for Federal Student Aid (FAFSA) form. Method C is the

preferred method as most students that do not qualify for a fee waiver based on Methods A and B, do qualify when they file the FAFSA.

Visit www.cccapply.org/money to apply online.

Students may also download the application form from the website and return it in person to the Financial Aid Office (Bldg. 9B).

Students may apply for a BOGW at any point during the academic year. If students are determined eligible for a BOGW, it will be valid for the entire academic year. Students must reapply for a BOGW each year beginning with the summer term. Please refer to the Refund for BOGW policy on page 21 for information regarding refunds.

BOGW recipients are subject to loss of BOGW eligibility when they are on probation for two consecutive semesters with academic and/or progress probation. Only students identified as foster youth are exempt from this rule. There are provisions for regaining eligibility and an appeal process. You can find out more details at: www.mtsac.edu/financialaid/types-of-aid/state-aid-programs.html

NOTE: Since verification of eligibility may involve contact with other agencies, parental signature, or other documents, it is reasonable to expect that an application may not be completed on the same day it is submitted.

How To Add Yourself To A Wait List

STEP 1. Type the five-digit Course Reference (CRN) in the area provided for each course you are trying to add. **(A)**

STEP 2. After you hit the Submit Changes button, you will receive the following message. **(B)**

STEP 3. Click on the Action box, select Wait List. **(C)**

STEP 4. You will see the following message indicating you are now on the Wait List. **(D)**

Panel A: The 'Add Classes Worksheet' form. The 'CRNs' field contains five empty boxes. A callout 'A' points to these boxes.

Panel B: The 'Add Classes Worksheet' form after clicking 'Submit Changes'. The 'Action' dropdown menu is open, showing 'None' selected. A callout 'B' points to the dropdown.

Panel C: The 'Add Classes Worksheet' form after selecting 'Wait List' from the dropdown. The dropdown now shows 'Wait List'. A callout 'C' points to the dropdown.

Panel D: The 'Current Schedule' section. The 'Status' row shows 'Wait List on Mar 16, 2015'. A callout 'D' points to this row.

Tables:

MAXIMUM NUMBER OF UNITS ENROLLED

Term	Good Standing	Probation Standing
Spring/Fall	18	12
Winter/Summer	7	4

Registration Add Errors

Status	Action	CRN	Subj	Crse	Sec	Level	Cred	Grade	Mode	Title
Closed To waitlist this class select WaitList from the drop down list and click on "Submit Changes."	Note	41275	SPCH	1A	25	Credit	4.000	Standard	Letter	Grade Public Speaking

Current Schedule

Status	Action	CRN	Subj	Crse	Sec	Level	Cred	Grade	Mode	Title
Wait List on Mar 16, 2015	None	41275	SPCH	1A	25	Credit	0.000	Standard	Letter	Grade Public Speaking

Summary:

- Total Credit Hours: 0.000
- Billing Hours: 0.000
- Minimum Hours: 0.000
- Maximum Hours: 18.000
- Date: Mar 16, 2015 03:07 pm

How To Add Yourself To A Wait List

STEP 5. To view your wait list course(s), Select Self Service Links No. 13 - View your waitlist from the Student tab. **(E)**

STEP 6. You will see the date you placed yourself on the Wait List and Position. **(F)**

STEP 7. You will be notified via your Mt. SAC Email Account when an opening is available and given 72 hours to enroll in the course.

STEP 8. Go to your portal and select Student Tab and Select Self Service Links option No. 4. under the Action tab. Click on the drop down arrow and select Web Registered, make sure you hit Submit Changes. **(G)**

Student Self Service

Registration

1. Apply for Admission
2. Review Existing Application
3. Select Term
4. Register (Add or Drop) Classes
5. Change Class Grading Option
6. Week at a Glance
7. Registration Fee Assessment
8. Registration Appointment/Hold
9. Active Registration
10. Registration History
11. Print Your Schedule/Receipt
12. Search for Classes
13. View Your Waitlist

E

Student Records

14. View Assessment/Placement Test Scores
15. View Holds
16. Final Grades
17. Grade Detail
18. View Unofficial Transcript
19. Request Official Transcript
20. View Status of transcript Request
21. View College Catalog
22. View Student Information
23. Request Enrollment Verification

Personal Information Student Employee Finance
RETURN TO MENU SITE MAP HELP

Search

Student Detail Schedule

Total Credit Hours: 0.000

Public Speaking - SPCH 1A - 25

Associated Term: Spring 2015
 CRN: 41275
 Status: Wait List on Mar 16, 2015
 Waitlist Position: 1
 Notification Expires:
 Assigned Instructor: John W. Vitullo

Grade Mode: Standard Letter Grade
 Credits: 0.000
 Level: Credit
 Campus: Mt. San Antonio College

Scheduled Meeting Times

Type	Time	Days	Where	Date Range	Schedule Type	Instructors	Email	Office Location
Class	10:45 am - 12:50 pm	MTWR	Bldg. 21H	1 Apr 20, 2015 - Jun 14, 2015	Lecture and/or discussion	John W Vitullo (P)	jvitullo@mtsac.edu	

Current Schedule

Status	Action	CRN	Subj	Crse	Sec	Level	Cred	Grade Mode	Title
Wait List on Mar 17, 2015	<div style="border: 1px solid gray; padding: 2px; display: inline-block;"> None Drop Before Class Begins **Web Registered** </div>	41261	SPCH	1A	10	Credit	0.000	Standard Letter Grade	Public Spee

Total Credit Hours: 0.000
 Billing Hours: 0.000
 Minimum Hours: 0.000
 Maximum Hours: 18.000
 Date: Mar 17, 2015 11:46 am

Add Classes Worksheet

CRNs

--	--	--	--	--	--	--	--	--

Paying Fees Online

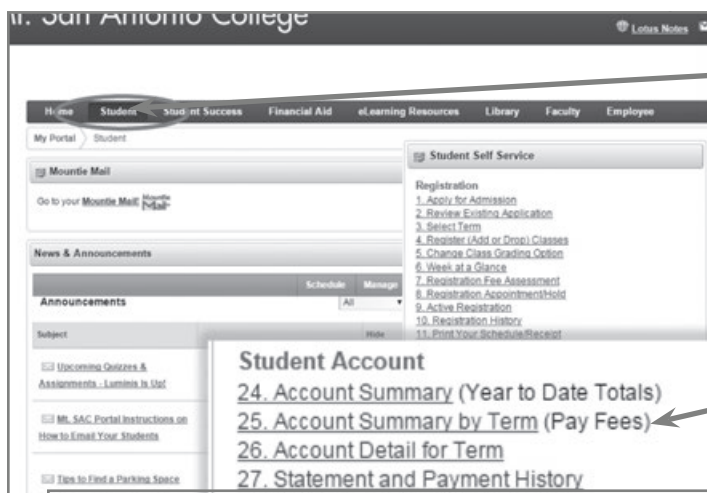

STEP 1. Login to the Mt. SAC portal.

STEP 2. Click on the Student tab. **(A)**

STEP 3. Click on #25. Account Summary by Term (Pay Fees) **(B)** under the Student Self-Service links.

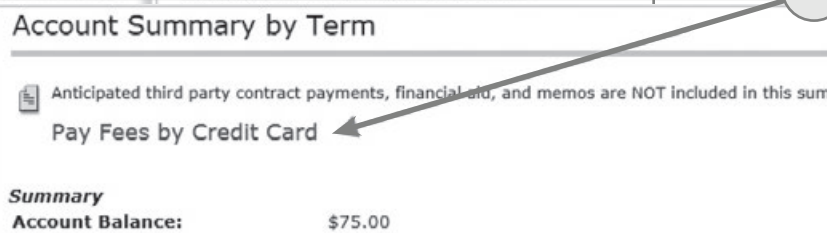

STEP 4. Verify your fees, then click on Pay Fees by Credit Card. **(C)**

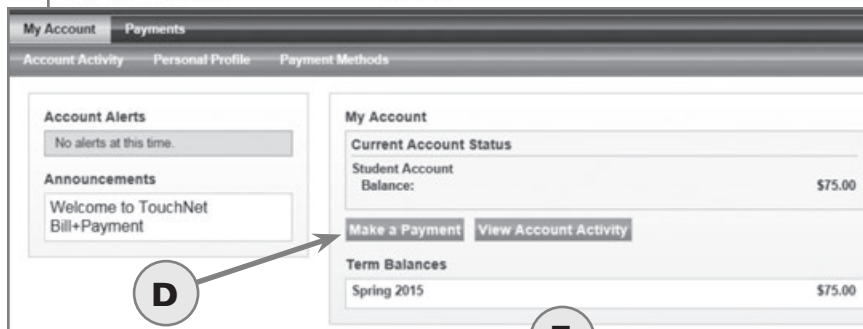

STEP 5. Click on Make a Payment. **(D)**



STEP 6. The balance will display once again, click Make a Payment. **(D)**

STEP 7. Select payment: Click on Current account balance or Pay by term **(E)** and click Continue.



STEP 8. Select Payment Method: Click on the dropdown menu to select Credit or Debit Card **(F)** and click Select.

Paying Fees Online

STEP 9. Fill in credit or debit card number and click Continue. (G)

STEP 10. Verify information and click Submit Payment (H)

STEP 11. Once you see the payment receipt (print for your records), then click on Log Out. (I)

Amount	Payment Method	Confirmation	Payment Receipt
\$75.00	Credit Card	xxxxxxxxxxxx1111	Joe Mountie

STEP 12. Navigate back to your portal. Click on Student Self-Service Links Option # 11-Print your Schedule/ Receipt (J) and verify you have no fees.

Detail Code	Description	Charge	Payment	Balance
ENRL	Enrollment	\$690.00	\$0.00	\$0.00
HTHF	Health Fee	\$18.00	\$0.00	\$0.00
SREP	Student Representation Fee	\$0.50	\$0.00	\$0.00
STAF	Student Activity Fee	\$11.00	\$0.00	\$0.00
VSA2	Visa (Web Credit Cards)	\$720.80	\$0.00	\$0.00
Term Charges:		\$720.80		
Term Credits:		\$720.80		
Term Balance:		\$0.00		\$0.00
Previous Balance:		\$0.00		\$0.00
Account Balance:		\$0.00		\$0.00

TouchNet: Authorized Users

TouchNet gives students the ability to authorize access to their payment information to another individual (e.g., parent, guardian). To do so, the student must first add the individual to their account by following the steps below. The system will then assign the individual his/her own login ID and password to log in and make payments for the student (instructions on pg.4). Returning authorized users can go to <http://www.mtsac.edu/payments> to login.

ADDING AN AUTHORIZED USER:

- STEP 1.** Login to the Mt. SAC portal.
- STEP 2.** Click on the Student tab (A).
- STEP 3.** Click on #25. Pay Fees (B) under the Student Self-Service links.
- STEP 4.** Click on Pay Fees by Credit Card (C).
- STEP 5.** Click on the Authorized Users tab (D).
- STEP 6.** Enter E-mail address of authorized user in the designated box.
- STEP 7.** Select Yes or No on the question regarding payment history.
- STEP 8.** Click Continue.

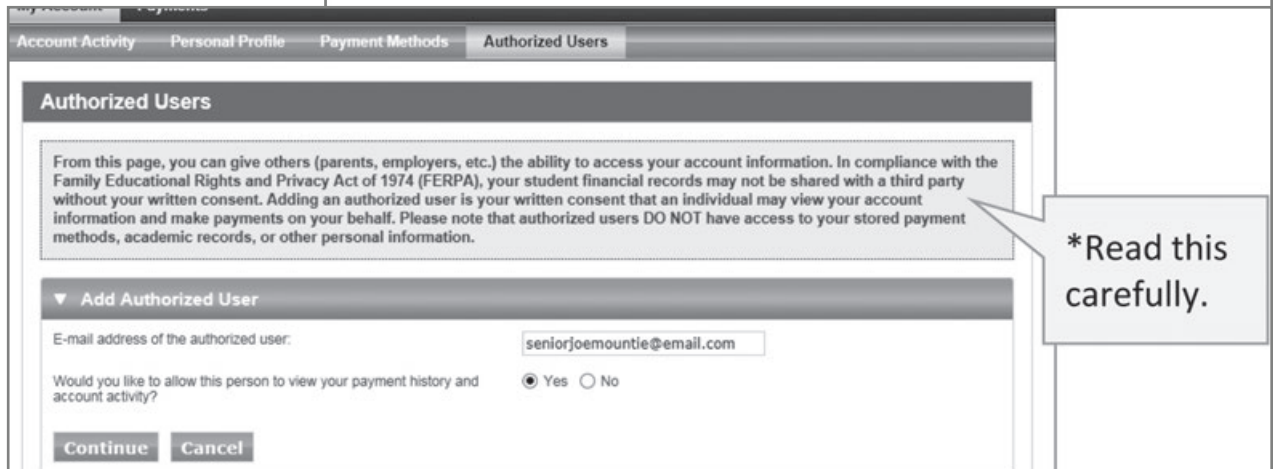
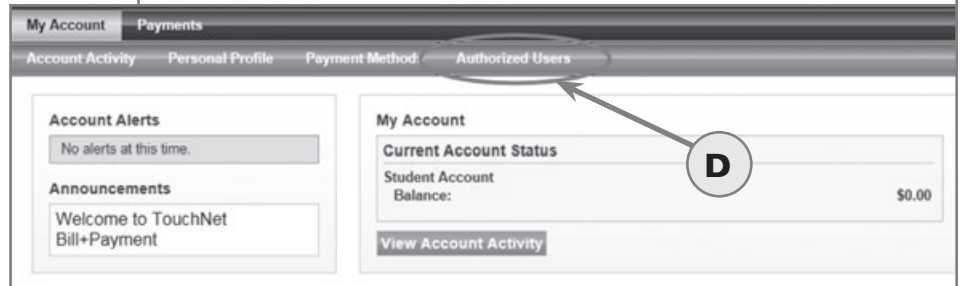
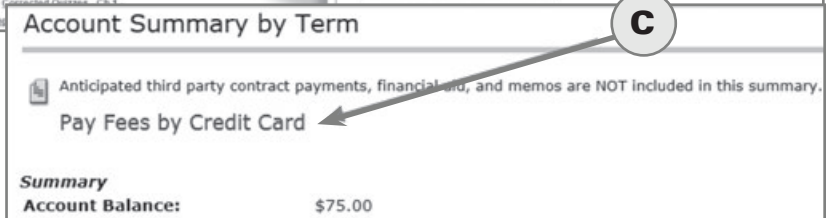
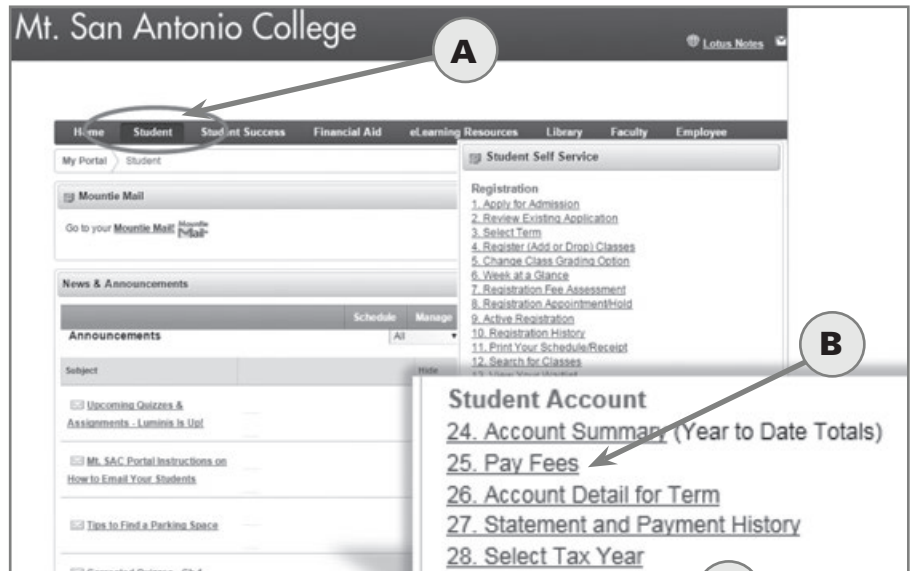

TouchNet: Authorized Users

Agreement to Add Authorized User

I hereby authorize **Mount San Antonio College** to grant **seniorjoemountie@gmail.com** partial access to my accounts, including ability to view my payment history and/or make payments accordingly. My payment methods, billing statements, and credit card and/or checking account information will remain confidential and hidden from all other users. I understand that I am still primarily responsible for ensuring that all my accounts are paid on time and in full.

This agreement is dated Tuesday, November 15, 2016.

For fraud detection purposes, your internet address has been logged.
140.144.127.1 at 11/15/16 1:31:58 PM PST

ANY FALSE INFORMATION ENTERED HEREON CONSTITUTES AS FRAUD AND SUBJECTS THE PARTY ENTERING SAME TO FELONY PROSECUTION UNDER BOTH FEDERAL AND STATE LAWS OF THE UNITED STATES. VIOLATORS WILL BE PROSECUTED TO THE FULL EXTENT OF THE LAW.

Please check the box below to agree to the terms and continue.

I Agree

[Print Agreement](#) [Continue](#) [Cancel](#)

STEP 9. Read the agreement prompt carefully and check I Agree, if you agree with the terms. If you do not agree click Cancel to end the process (E).

STEP 10. Click Print Agreement if you wish and/or click on Continue.

My Account Payments

Account Activity Personal Profile Payment Methods **Authorized Users**

Authorized Users

Thank you. We have sent an e-mail to **eojeda002@gmail.cpm** with instructions on how to log in and view your payment plan information. This person will log in using the e-mail address you provided.
(Note: If the e-mail delivery fails for some reason, a notification MAY be sent to your e-mail address on record.)

From this page, you can give others (parents, employers, etc.) the ability to access your account information. In compliance with the Family Educational Rights and Privacy Act of 1974 (FERPA), your student financial records may not be shared with a third party without your written consent. Adding an authorized user is your written consent that an individual may view your account information and make payments on your behalf. Please note that authorized users DO NOT have access to your stored payment methods, academic records, or other personal information.

Current Authorized Users

When you delete an authorized user, that person will no longer be able to make payments to your accounts. Any scheduled payments by that person that have not already been applied will be cancelled.

Full name:	E-mail address:	Action
	eojeda002@gmail.cpm	Edit Delete Show Agreement

*You can edit or delete authorized user in this screen.

Students and Staff

*Indicates required information
*University ID:
*Pin:
[Login](#)

Authorized Users

Login for parents or others who have been granted access.

*E-mail:
*Password:
[Login](#)

Forgot your password?
Have a temporary password emailed to you.

Welcome

Welcome to Mount San Antonio College Student Account Suite. This site is a 24x7 service offered to students and their families for making payments and managing their student account.

Students and staff may log in using their University ID and Pin. Parents, guardians, or employers wishing to access the system require student permission via the student's authorized user process. If you have any questions about the system, please send e-mail to barsar@mtsac.edu.

Student Account Suite Features

Student Account Capabilities

- Check your balance.
- Make a payment towards your balance.
- View your payment history.
- Store your payment methods for quick and easy payment.
- As a student, provide permission to others (parents, employers, etc.) to make payments.

STEP 11. An email will be sent to the authorized user with instructions on how to login and view payment information.

AUTHORIZED USER LOGIN:

STEP 1. Click on the link provided in the email sent to you by Studentinfo@mtsac.edu and enter your login information provided in the email (F). Returning users click here to login.

My Account Payments

Account Activity Personal Profile Payment Methods **Select Student**

Cancelled making payment!

Account Alerts

No alerts at this time.

Announcements

Welcome to TouchNet Bill+Payment

My Account

Current Account Status

Student Account Balance:

[View Account Activity](#)

STEP 2. Fill in your personal information and type in a new password to complete your profile. Click Save.

STEP 3. Click on View Account Activity to make a payment (G).

Prerequisites, Corequisites and Advisories

Prerequisites and Advisories

Faculty at Mt. SAC have established prerequisites, corequisites and advisories for courses. Please refer to the course descriptions in the *Schedule of Classes* or college *Catalog* for prerequisites, corequisites and advisories. **If students do not meet the prerequisite or corequisite requirements, they will be blocked from enrolling in those courses.** Transcripts and grade report cards from other colleges must be evaluated prior to registration to satisfy pre- and corequisites.

Prerequisite

Prerequisites to a course are those courses which must have been taken previously as preparation for the course. To enroll in a class that has a prerequisite, students must complete the required preparation prior to enrolling in the course. In some instances, **English, Reading, Math and Chemistry prerequisites** may be met by attaining eligibility through assessment. All **course prerequisites** listed must be completed with a grade of "C" or better, unless otherwise stated.

Corequisite

To enroll in a course that has a corequisite, the corequisite course must be taken at the same time. In some instances, a corequisite may have been taken previously.

Advisory

An advisory to a course is preparation which is highly recommended by faculty teaching the course. Although students may enroll in a course if they do not possess the advisory skills, they are encouraged to abide by an advisory whenever possible.

IMPORTANT NOTE TO STUDENTS

To comply with State law, students enrolled in courses with prerequisite requirements will be automatically dropped from any course where those prerequisites have not been completed. This may occur if they were enrolled in the prerequisite course at the time they registered for the current term and failed to complete that course successfully.

Students who are uncertain about their status regarding completion of prerequisite requirements may go to Counseling Center for assistance.

If a student is currently enrolled in the prerequisite course and is not sure of the grade, he or she may:

- 1) Check with the instructor, or**
- 2) Go to the appropriate Division Office the first day of the new semester.**

Students will receive notification if they are dropped from any course for this reason.

Prerequisite Challenge Process

In accordance with Title 5 Section 55003 (p) and (q), Student Challenge of Prerequisites or Corequisites, students may challenge a prerequisite or corequisite for a course. A prerequisite or corequisite cannot be "waived," but students have the ability to demonstrate that they meet the prerequisite or corequisite on the following criteria, and course eligibility may be granted. The challenge must be based on at least one of the following specific grounds:

- The College will accept prerequisite or corequisite courses from regionally accredited colleges and universities in the United States. (The student will meet with the appropriate department chair)
- A student may request a prerequisite or corequisite variance to demonstrate that the student has the knowledge or ability equivalent to the prerequisite or corequisite for the course in question, but has not formally met the established prerequisite or corequisite. (The student will meet with the appropriate department chair)
- The prerequisite or corequisite course has not been made reasonably available, and waiting until the prerequisite or corequisite is offered will create an undue delay in meeting educational goals. (The student will meet with the Director of Assessment and Matriculation)
- The prerequisite or corequisite is being applied in a discriminatory manner. (The student will meet with the Director of Assessment and Matriculation)
- The prerequisite violates the provisions of the State Education Code. (The student will meet with the Director of Assessment and Matriculation)

Placement Test Information

Placement Test Information

ATTENTION STUDENTS:

The College is in the process of revising how to assess students for placement into English and math courses. The process by which most students will be placed in English and math courses will be primarily based on students' high school coursework, high school grades, and overall high school grade point average (GPA). Continuing students who were previously assessed by the English and math placement tests will have the option to be re-assessed using the new assessment process. More information will be posted in the student portal. Please continue to check your portal (inside.mtsac.edu) for updates.

Assessment is required of all students attending Mt. SAC or any other California Community College. Most classes have basic skills prerequisites that must be assessed prior to registration. Course eligibility may be determined by placement tests or previous coursework. In some instances English, Reading, Math and Chemistry prerequisites may be met by attaining eligibility through assessment. In addition:

- Students may retest after three months
- Test scores are valid for two years
- A valid photo I.D. is required to take ALL tests and to obtain test results

The following tests may be taken at the Assessment Center:

English Placement Test Assessment of Written English (AWE) **1 hour***

This is a test of your abilities in language usage. It is required for placement in English classes (*including LERN, AMLA, and ESL classes*). The AWE is used to provide eligibility for the following courses:

ESL	English as a Second Language
AMLA 41W	American Language, Basic Writing
AMLA 42W	American Language, Intermediate Writing
AMLA 43W	American Language, Advanced Writing
LERN 81	Improving Writing
ENGL 67¹	Writing Fundamentals
ENGL 68²	Preparation for College Writing
ENGL 90¹	Accelerated Developmental Writing
ENGL 1A	Freshman Composition

¹Students eligible for ENGL 67 have two options: A) Enroll in ENGL 67; or B) Enroll in ENGL 90. Students will be eligible to enroll in ENGL 1A after successful completion of ENGL 90.

²Students eligible for ENGL 68 have two options: A) Enroll in ENGL 68; or B) Concurrently enroll in both ENGL 1A and ENGL 66 - Paragraph Writing.

Reading Placement Test Degrees of Reading Power (DRP)

This is a test of your current reading abilities. The results will be used to provide eligibility for the following courses:

Degrees of Reading Power (DRP)

READ 70	Improving Reading Comprehension
READ 80	Developing Reading Comprehension
READ 90	Preparing for College Reading
READ 100	Analysis and Critical Reading

Mt. SAC Math Placement Test **1 hour***

This is a test of your arithmetic and pre-algebra skills.

The appropriate test score will provide eligibility for the following courses. **Please see the course descriptions in the *Schedule of Classes* for prerequisites.**

LERN 48	Basic Math Skills Review
LERN 49	Math Skills Review
MATH 50	Pre-Algebra
MATH 51³	Elementary Algebra
MATH 51A	Elementary Algebra - First Half
MATH 70S³	Integrated Intermediate Algebra

³Students eligible for MATH 51 may enroll in MATH 70S. Students will be eligible to enroll in MATH 110S-Integrated Statistics after successful completion of MATH 70S.

Intermediate Algebra Placement Test **1 hour***

This is a test of your elementary algebra skills. The appropriate test score will provide eligibility for the following courses. **Please see the course descriptions in the *Schedule of Classes* for prerequisites.**

MATH 61	Plane Geometry
MATH 71	Intermediate Algebra
MATH 71A	Intermediate Algebra – First Half
MATH 71X	Practical Intermediate Algebra

College Level Math Placement Test **1 hour***

This is a test of your intermediate algebra skills. The appropriate test score will provide eligibility for the following courses. **Please see the course descriptions in the *Schedule of Classes* for prerequisites.**

MATH 100	Survey of College Mathematics
MATH 110	Elementary Statistics
MATH 120	Finite Mathematics
MATH 130	College Algebra
MATH 150	Trigonometry
MATH 160	Pre-Calculus Mathematics (Trigonometry Supplement Test may also be required)

Calculus Placement Test **1 hours***

This is a test of your algebra and trigonometry skills. The appropriate test scores will provide eligibility for the following courses. **Please see the course descriptions in the *Schedule of Classes* for prerequisites.**

MATH 140	Calculus for Business
MATH 180	Calculus and Analytic Geometry

Chemistry Placement Test **1 hour***

Appropriate test scores AND transcripts verifying successful completion of the required courses will provide eligibility for the following course. **Please see the course descriptions in the *Schedule of Classes* for prerequisites.**

CHEM 50	General Chemistry I
----------------	---------------------

* Not actual test time. Time indicated may vary slightly depending on time necessary for administration and instructions.

Exemption from Assessment

A student is exempt from assessment if the student has:

1. completed an Associated degree or higher from a regionally accredited institution;
2. enrolled at the College for a reason other than career development or advancement, transfer, attainment of a degree, or certificate of achievement, or

Placement Test Information

- completion of a basic skills, or English as a Second Language course sequence;
- completed these services at another community college within a time period identified by the College;
 - enrolled at the College solely to take a course that is legally mandated for employment as defined Section 55000 or necessary in response to a significant change in industry or licensure standards;
 - enrolled at the College as a special admission student pursuant to Education Code section 76001.

Test Scores from Other Colleges

The Assessment Center will accept math test scores from other colleges that use the Mathematics Diagnostic

Testing Project (MDTP) placement tests if the test was taken less than two years ago. An official copy of the test scores must be brought or mailed to the Assessment Center for evaluation and course placement. The following are placement levels for the tests we accept:

MDTP – Elementary Algebra Test

MATH 71 MATH 61

MDTP – Intermediate Algebra Test

MATH 100 MATH 110 MATH 120
MATH 130 MATH 150 MATH 160

MDTP – Pre-Calculus Test

MATH 140 MATH 180

Mt. SAC **does not** accept English Placement test scores from other colleges.

Changing Your Class Schedule

Changing Your Class Schedule

You can make changes to your course schedule by using the Online Registration System.

- You may drop classes.
- You may add open classes or any class for which you have an ADD Authorization Code.
- You may search for open sections at www.mtsac.edu/searchforclasses/
- It is your responsibility to know deadlines to add courses and to drop courses that you are no longer attending. You must use the online registration system to drop classes.
- You must pay the required fee for any added class and drop by the course refund deadline on student Schedule/Receipt to qualify for a refund (see page 21).

Adding or Dropping a Class

A. To Add an Open Class:

- You may add open classes online at **inside.mtsac.edu**. Verify your add by printing your schedule/receipt.
- Once classes start, you must attend the first class meeting to obtain an ADD Authorization Code if the class is no longer available through the registration system. Instructors will add students depending on the number of open spaces in the class.
- You must have your Mt. SAC registration appointment printout of your assigned date and time, along with a picture ID.**
- You must be **eligible** (have the appropriate prerequisite) for the class. Prerequisites will be checked by the system at the time you register for the class. If you are blocked from registering for a class and believe that you do possess the appropriate prerequisite, or if you have a question regarding the prerequisite, call Admissions and Records at **(909) 274-4415** for assistance.
- You must register for all ADDs prior to the expiration date on the ADD Authorization Code.

- You MUST have a picture ID to add classes in person at Admissions & Records.
- B. To Add a Closed Class:**
- To add the class, you must attend the first class meeting and obtain an ADD Authorization from the instructor.
 - You must have your Mt. SAC student schedule printout and a picture ID.**
 - You must be **eligible** (have the appropriate prerequisite) for the class. If the course has a required prerequisite, obtain a Proof of Eligibility Form from the appropriate Division Office or Admissions and Records prior to attending the class you wish to add.
 - If you receive an ADD Authorization Code from the instructor, add the class online.
 - Registration for all Added classes must be completed prior to the expiration date on the ADD Authorization Code.**

ADD AUTHORIZATION CODES: A 4 digit code is issued by the instructor of a closed class. You must enter the Course Reference Number (CRN) and the ADD Authorization Code when prompted at **inside.mtsac.edu** to add the closed class. ADD Authorization Codes can only be used once and have expiration dates. Be sure to use the code on or before the expiration date. Failure to use the codes prior to expiration will prevent students from adding the class.

WAIT LISTS: Wait lists will be available beginning the first day of registration.

C. To Drop a Class:

- Drop classes online at **inside.mtsac.edu**. Verify your drops by printing your schedule/receipt.
- See your Schedule/Receipt for important deadlines related to dropping classes.
- See page 21 for refund information.

Course Policies

Attendance

Students should check their Schedule for the day and time their classes meet and ALLOW PLENTY OF TIME TO PARK AND LOCATE THE CORRECT CLASSROOM.

Students who enroll in class must attend the first class meeting. Any student who has not arrived within the first 30 minutes of the first class meeting may be dropped from the class roster and the place given to a waiting student who was unable to enroll at the time of registration. Failure to attend the first class meeting does not ensure that you will be dropped. **It is the student's responsibility to drop a class.**

Success in college depends upon regular class attendance. Poor attendance can result in a low grade in a class. Instructors may drop a student who has excessive absences. It is each student's responsibility to know the attendance policies of each of his/her instructors.

Students are responsible for dropping classes they do not plan to attend. Failure to drop will result in an "F" letter grade on a student's transcript.

Auditing

Students are not permitted to audit classes. All individuals attending, visiting, participating or sitting in the class must be officially registered in that particular class.

Course Repetition

Only certain courses may be repeated for credit.

Refer to the latest Mt. SAC Catalog regarding the repeatability allowance for specific courses. If a course is repeatable, the course may only be repeated for the number of times indicated. Students are allowed to repeat a course in which they received a substandard grade/mark ("D," "F," "W," "NC," "NP") only two times (for a total of three attempts). Students attempting to enroll in the same course a fourth time will be blocked automatically from registering.

Courses for which satisfactory grades of "A," "B," "C," or "Pass" are received may not be repeated. Only upon extenuating circumstances will repetition in courses for which the student has satisfactorily passed be allowed. Students with extenuating circumstances may file a Petition for Exceptional Action form in the Admissions and Records Office. Students who repeat courses based on this provision will not earn additional units or grade points toward improving or changing the previous grade earned in the class or toward changing the overall grade point average.

Dropping Courses and Withdrawing from the College

It is the students' responsibility to drop or withdraw from courses they no longer attend. Students should check their schedule/receipt, available on the "My Mt SAC" portal for information regarding key dates. Dates vary and are often course specific.

Full 16-week courses

For 16 week courses, students who drop a class, withdraw

from the college, or are dropped from a class by the professor by the Sunday at the end of the second week of classes will not receive any mark or notation on their permanent academic record.

Students who drop a class, withdraw from the college, or are dropped by the professor beginning Monday of the third week of a 16 week class will receive a mark of "W" (Withdrawal) on their permanent record.

Professors may not drop students from a class and students may not drop themselves from any class or withdraw from the college after 60% of the class has elapsed. All students who are registered for a class after 60% of the class has elapsed shall receive an academic grade (A,B,C,D,F,P,NP) or an Incomplete mark for the class. A "W" Withdrawal mark shall not be assigned to any student enrolled after the last day to drop a class except in the case of an approved petition due to extenuating circumstances. A "W" Withdrawal remains a permanent part of a student's academic record.

Intersessions and other short term classes

For short term classes, students who drop a class, withdraw from college or are dropped from a class by the professor prior to the conclusion of the first 20% of the class will not receive any mark or notation on their permanent record.

Students who drop a class, withdraw from the college, or are dropped by the professor after 20% of the class has elapsed will receive a mark of "W" (Withdrawal) on their permanent record.

Professors may not drop students from a class and students may not drop themselves from any class or withdraw from the college after 60% of the class has elapsed. All students who are registered for a class after 60% of the class has elapsed shall receive an academic grade (A,B,C,D,F,P,NP) or an Incomplete mark for the class. A "W" Withdrawal mark shall not be assigned to any student enrolled after the last day to drop a class except in the case of an approved petition due to extenuating circumstances. A "W" Withdrawal remains a permanent part of a student's academic record.

Student Load Limits

Without petitioning, students may enroll in up to 18 units each semester and up to 7 units each summer and winter intersession. Students who have completed a minimum of 15 college units in a given semester with a grade point average of at least 3.0 and have a minimum cumulative grade point average of at least 3.0 may petition for permission to enroll in units above the maximum. Petitions for Exceptional Action are available in the Counseling Center, located on the upper level of the Student Services Center.

Petition for Exceptional Action

Petition for Exceptional Action forms are available from the Counseling Center and Admissions and Records Office in the Student Services Center. Action on a petition will be taken either by the appropriate administrator or the Board of Appeals.

Grades

Final Grades

Final grades for the previous semester will be available online via ***inside.mtsac.edu*** beginning the third week of the following term.

- When you visit ***inside.mtsac.edu***, you will be directed to the appropriate screen to view your transcript.
- If you need a copy of your grades, you can obtain a student copy of your Mt. SAC transcript on your portal. You can request **official** transcripts online through ***inside.mtsac.edu*** student portal.

Pass/No Pass Grades

Some classes offered at Mt. SAC are available with two different grading options: letter grade (A, B, C, D, F) or a Pass/No Pass (Pass: A, B, or C; No Pass: The equivalent of D or F).

A few classes are offered for Pass/No Pass only. These courses are designed to encourage students to explore areas outside their major field of study in order to broaden and enrich their collegiate experience, and to afford an opportunity for departments to offer courses in which there is diminished emphasis on grades. **The Pass/No Pass grading option is not available for General Education courses.**

In courses offering both grading options, students are automatically registered on a letter-grade basis at the time of registration. If a change is desired, students must declare their intent to be graded on a Pass/No Pass basis.

Credit toward graduation by using Pass/No Pass classes is limited to a maximum of sixteen units. Courses taken for Pass/No Pass are not counted in calculating the grade point average, or in determining eligibility for the Dean's List or President's List. However, these courses are considered in probation and dismissal procedures.

Incomplete Grades

A faculty member may approve a petition for an Incomplete, "I," for work missed commencing with the 14th week of a regular semester (or after 85% of a short-term class) under the circumstances listed below:

- A. Verifiable serious illness or emergency
- B. Verifiable work conflict
- C. Call to active military duty

The requirements for removal of the "I" shall be stated by the instructor on the "Petition to Request Incomplete Grade" form. Approval of an incomplete and the assignment of a replacement grade are at the discretion of the instructor. If the "I" is not made up within one year of its issue, the predetermined replacement grade will be assigned. If a grade was not predetermined, the "I" will revert to an "F" **Students may not re-register in a class while an "I" is in effect for that class.**

Fee Refund Policy

Fee Refunds

Refunds are now automatic. In order to receive a refund, you must drop your class(es) by the refund deadline for that class. The deadline can be found on your Student Schedule/Receipt (see sample below). Classes that do not attain minimum initial enrollment may be cancelled. **Students who have dropped or cancelled classes will receive a refund through their preference on BankMobile (formerly Higher One card).** Students will also be entitled to refunds for textbook(s) purchased if such textbook(s) have not been marked.

Parking Permit Refund

To receive a refund for your current parking permit, you must return the permit to the Bursar's Office. This can be done in person, by mail or dropped off at the Bursar's Office drop box. The deadline is March 12, 2018. Once the permit is received, your refund will be processed and sent to your Mt. SAC card preference.

Production & Copy Cards Refunds

Production cards can be returned to the Bursar's Office for refund until March 12, 2018, if unmarked and unused.

Refund for BOGW

You may apply for a Board of Governors Fee Waiver (BOGW) at any point within the academic year. If you qualify and have already paid, you will be automatically reimbursed for covered fees in the form of a refund through your preference at BankMobile.

Mt. San Antonio College Student Schedule/Receipt Spring 2015

SAMPLE

Schedule for
16-MAR-2015

Your Registration Begins: 15 JAN 2015 at 7:00am

Enrolled Courses										
Crn	Subj	Crse	Title	Crd	Start Date	End Date	Times	Days	Bld	Rm
40973	ENGL	1A	Freshman Composition	4.0	23-FEB-15	14-JUN-15	12:00- 2:05pm	M W	26A	3620
41374	SPAN	1	Elementary Spanish	4.0	23-FEB-15	14-JUN-15	9:00- 1:15pm	F	66	248
41930	BIOL	21	Marine Biology Lab	1.0	23-FEB-15	14-JUN-15	9:45-12:55pm	T	7	1115
42098	KIN	34	Fitness for Living	3.0	23-FEB-15	14-JUN-15	9:45-11:10am	M W	45	1462
43074	BIOL	20	Marine Biology	3.0	23-FEB-15	14-JUN-15	1:15- 2:40pm	T R	11	2312
44211	BS	LANG1	Language Skills Laboratory	0.0	23-FEB-15	14-JUN-15	TBA		6	264

Additional Information							
Crn	Subj	Crse	Instructor	Email	Refund Deadline	Last Day to Drop Without a W	Last Day to Drop With a W
40973	ENGL	1A	Boehner-Staylor, Maya C.	mstaylor@mtsac.edu	06-MAR-15	08-MAR-15	01-MAY-15
41374	SPAN	1	Baler, Pablo F.	pbaler@mtsac.edu	06-MAR-15	08-MAR-15	01-MAY-15
41930	BIOL	21	Schmidt, Sherry E.	sschmidt@mtsac.edu	06-MAR-15	08-MAR-15	01-MAY-15
42098	KIN	34	Sanchez, Juan C.	jsanchez@mtsac.edu	06-MAR-15	08-MAR-15	01-MAY-15
43074	BIOL	20	Bava, Jose	jbava@mtsac.edu	06-MAR-15	08-MAR-15	01-MAY-15
44211	BS	LANG1	Marcy, Peggy C.	pmarcy@mtsac.edu	12-JUN-15	12-JUN-15	12-JUN-15

Account Information

Any unpaid fees that result after the semester begins will be placed on a financial hold. Financial holds will prevent students from enrollment, transcripts, withdrawals and prohibit access to certain campus services.

It is the student's responsibility to drop classes by the appropriate deadline as shown above. Students who remain enrolled after the refund deadline are not eligible for a refund and remain financially responsible for payment of fees even if they drop the class or are dropped by their instructor.

Refunds are processed when classes are dropped by the course refund deadline date (see above). You will receive a refund through your preference on your MtSAC Card. See <http://myportal.mtsac.edu> for further information. For parking permit refund deadlines see the current [Schedule of Classes](#).

Account Summary for

Account Balance: \$0.00

Spring 2015

Detail Code	Description	Charge	Payment	Balance
ENRL	Enrollment	\$690.00		\$0.00
HTHF	Health Fee	\$19.00		\$0.00
SREP	Student Representation Fee	\$0.50		\$0.00
STAF	Student Activity Fee	\$11.00		\$0.00
VSA2	Visa (Web Credit Cards)		\$720.50	\$0.00
	Term Charges:	\$720.50		
	Term Credits :		\$720.50	
	Term Balance:			\$0.00
	Previous Balance:			\$0.00
	Account Balance:			\$0.00

Student Services and Resources

Please visit the website or call for current hours of operation

Accessibility Resources for Students (formerly known as DSPS)

Ext. 4290

Bldg. 9B

www.mtsac.edu/access

The Access Center provides services to students who have professionally documented disabilities and need additional services to successfully attend classes at Mt. SAC. Students who suspect they might have a disability are welcome to apply for services and an eligibility determination will be made. **Disability-related information about students is held in the strictest confidence.**

Based on individual disability-related needs, some of the services include specialized counseling, priority registration assistance, assessment of disability and educational needs, access to an adaptive computer lab, equipment loans, sign language interpreters, note takers in the classroom, classroom and testing accommodations, transportation around campus, and many other services and accommodations.

ACES Program (Achieving in College, Ensuring Success)

Ext. 4411

Bldg. 9E

www.mtsac.edu/aces

ACES (Achieving in College, Ensuring Success) is a TRiO Student Support Services Program that was established by Congress to help students overcome class, social, academic, and cultural barriers to higher education. The ACES Program is funded by a \$213,180 per year grant from the U.S. Department of Education. ACES is designed to assist students who are low-income and/or the first in their family to attend college and/or disabled to obtain an Associates Degree and transfer from Mt. San Antonio College to a four-year institution. ACES services focus on a holistic approach to student development and student success. Participants will gain the knowledge and skills necessary to achieve their educational goals and ultimately obtain a bachelor's degree.

Admissions & Records

Ext. 4415

Bldg. 9B

www.mtsac.edu/admissions

The Admissions and Records office provides comprehensive admissions/registration services for all credit students, processes student requests for transcripts, enrollment verifications, general education (transfer) certifications, and graduation evaluations. Special services are provided for international (F-1 Visa) students. Assistance is available in English, Spanish, Vietnamese and Chinese.

Aspire Program

Ext. 6396

Bldg. 9F

www.mtsac.edu/aspire

Aspire is a student success program designed to enrich the experience of African-Americans and other students at Mt. SAC through counseling, instruction, mentoring,

and community building. Aspire's primary focus is to equip you with resources to boost your academic performance and help you reach your goals at Mt. SAC. Aspire students perform better, because they learn how to get the most from their college experience. They have caring mentors who encourage and motivate them to achieve their personal potential. Aspire students bond together as a "community" by sharing experience and participating in college tours, success workshops, tutoring, and campus activities.

Assessment Center

Ext. 4265

Bldg. 9B

www.mtsac.edu/assessment

Students may complete required English, Reading, Chemistry and Math placement testing in the Assessment Center. Assistance in reviewing course placement is also provided.

Bookstore (SacBookRac)

Ext. 4475

Bldg. 9A

bookstore.mtsac.edu/

Visit Bookstore website for current hours of operation and buyback hours and locations.

SacBookRac offers textbooks, school supplies, Mt. SAC apparel, gift items, and houses the Mt. SAC Photo ID area. Textbooks and supplies for students average between \$300 to \$600 per semester, depending upon the program of study selected. Students are encouraged to buy books early, especially to save money by purchasing used books. Books are sold on a first-come, first-served basis. Students may order textbooks online at www.sacbookrac.com. Orders can be picked up at the store or shipped to the student's home.

Refund Policy

Refunds are allowed within the first week of the start of each semester. The refund policy details are posted in the bookstore and are printed on a bookmark which is attached to the purchase receipt.

Bridge Program

Ext. 5392

Bldg. 9E

www.mtsac.edu/bridge

The Bridge Program offers several learning communities designed to increase students' academic and personal success through the structuring of the learning environment. Students participating in a learning community are enrolled in linked or clustered classes that are taught in a cooperative environment between instructors. There are various learning communities offered: Summer Bridge, Math Bridge, English Bridge and many more. Each learning community focuses on a specific academic need and has an assigned counselor to assist students. The Bridge Program is perfect for students who are the first in their family to attend college, want to improve academic and social skills, want to learn more about career and transfer options, or need additional support during their first year at Mt. SAC.

Student Services and Resources

Please visit the website or call for current hours of operation

Bursar's Office

Ext. 4960

Bldg. 4, Lower Level

www.mtsac.edu/bursars

The Bursar's Office manages the collection of credit registration fees and other campus fees including parking permits, replacements, parking citation fees, enrollment verification, and production cards. The office also processes refunds for credit classes, parking permits and production cards.

CalWORKs (California Work Opportunity and Responsibility to Kids)

Ext. 4755

Bldg. 9B

www.mtsac.edu/calworks

The CalWORKs program provides services to Mt. SAC students who are recipients of TANF/CalWORKs cash-aid for themselves and their children. The CalWORKs program serves as the liaison between the student and their county office. Support services include: educational planning, case management, job development/placement assistance, referrals to the basic skills tutoring/computer skills lab and the GED/High School diploma programs. Based upon available funding, childcare and work-study may be available. The CalWORKs program also provides support in complying with the 32/35 hours per week welfare-to-work requirement.

Career and Transfer Services

Bldg. 9B

careerservices.mtsac.edu

transfer.mtsac.edu

Career and Transfer Services helps students transition to their next goal of employment and/or transfer. We provide a variety of services, activities, events and resources to help students solidify career goals, sharpen job acquisition skills, acquire part- and full-time employment, and transfer to universities.

CAREER SERVICES

Ext. 4510

Activities, resources and events include:

- Job and internship referrals
- Career fairs
- Career acquisition skills workshops
- Mock interview sessions
- 1-on-1 assistance with résumé preparation, interviewing techniques, and general job search

TRANSFER SERVICES

Ext. 6388

Activities, resources and events include:

- Career and college guidebooks and university catalogs library
- Workshops on career and transfer topics
- University representative visits and appointments
- College fairs
- University tours
- Walk-in transfer advising
- Computers for career and transfer research, applications and more!

Child Development Center (Childcare Services)

Ext. 4920

Bldgs. 70-73

www.mtsac.edu/cdc

Admission Policy

Early care and education services are provided Monday through Friday for student-parents, staff/faculty, and community members. The Child Development Center welcomes children from 3 months through 5 years regardless of sex, ethnicity, or physical disability. A child must be in overall good health in order to attend. Parents seeking tuition assistance must meet income requirements and demonstrate a need for care with (one or a combination of) acceptable and verifiable activities: 6 or more units of credit courses, employment, work-study, job training programs, non-credit courses directly related to employment, etc.

Tuition Assistance and Payment Options

Half and full-day State Preschool programs, General Childcare, and CCAMPIS (Pell Grant) funding are available for eligible families. We also welcome CalWORKs and other alternative payment programs. Families not eligible for these funding sources may enroll in the tuition-based program. For information on tuition rates, contact the Center at (909) 274-4920.

Minimum Hours Requirements

Children must enroll a minimum of 20 hours per week.

Enrollment

Application and registration must be done in person at the Child Development Center. For more information, contact the Center at (909) 274-4920 or visit the website.

Counseling Center

Ext. 4380

Bldg. 9B

www.mtsac.edu/counseling

Students can take advantage of educational planning, career exploration and decision-making, and other services offered through the Counseling Center on the second floor of the Student Services Center.

Counselors are available to assist students who:

- are undecided about their major or career direction;
- need information about their career and transfer options;
- are having difficulty in their courses;
- need assistance with personal problems.

It is highly recommended that students see a counselor during their first semester at Mt. SAC to develop a student educational plan.

Counselors and educational advisors can also provide:

- information on course selection and planning for degree or certificate completion;
- information about major and transfer requirements to CSU, UC and private universities;
- general information about the college.

Student Services and Resources

Please visit the website or call for current hours of operation

DREAM Program

Ext. 5596

Bldg. 16C

<http://www.mtsac.edu/dream/>

The DREAM Program is part of the campus wide Student Equity (SE) efforts designed to provide support services for the success of Dreamers/Undocumented students at Mt. San Antonio College (Mt. SAC). Its purpose is to provide the space where Dream students can come together to receive the support they need to succeed in college.

The program strives to increase the personal growth and development of Dreamer students through academic, career and personal counseling, which is provided by a full-time faculty counselor, who brings extensive background and knowledge on how to guide and support Dreamers. Peer mentoring as well as educational workshops are available for students to encourage engagement and participation outside the classroom experience. Moreover, tutoring is also available to ensure the academic success of program participants. The DREAM Program provides assistance in applying for the California Dream Act/ Financial Aid and scholarship opportunities. Additionally, through its partnerships, the DREAM Program has a referral process to assist students in applying for DACA and/or Medical Services as well as other services relative to this student population. By using a holistic approach the DREAM Program strives to help students navigate the higher educational system and beyond.

Extended Opportunity Programs and Services (EOPS) and Cooperative Agencies Resources for Education (CARE)

Ext. 4500

Bldg. 9B

www.mtsac.edu/eops www.mtsac.edu/eops/care.html

EOPS provides support services to students with academic and financial disadvantages. Services include counseling, educational planning, peer advising, tutoring, book services, and priority registration. Mt. SAC's CARE program is designed to recruit and assist single parents who are heads of household with children 13 years old and under and who are TANF/CALWORKs cash aid recipients attending community college. To meet eligibility requirements for CARE, either the student or dependent child must receive cash aid. CARE students receive additional support through counseling, tutoring, assistance with books and supplies, and grants.

Financial Aid and Scholarships

Ext. 4450

Bldg. 9B

www.mtsac.edu/financialaid

www.mtsac.edu/scholarships

The Financial Aid Office provides assistance in applying for state and federal financial assistance, including grants, loans, scholarships, fee waivers and work study. Students must complete the FAFSA (Free Application for Federal Student Aid) form. The College's priority filing date is April 15 of each year for the following academic year. Information and applications for scholarships are also available throughout the year in the Financial Aid Office.

Food Services

www.mtsacdining.com

The Food Services Department provides the campus community with a cafeteria, coffeehouse, and four convenience stores.

Mountie Cafe

Bldg. 8, Ext. 5284

Located on the west side of campus next to SacBookRac, Mountie Café is the perfect meeting spot. Students will find diverse food options including:

- *Common Grounds featuring Starbucks* - we proudly brew hot and cold coffee drinks, frappuccino, fresh baked muffins, scones, and brownies..
- *SubConnection* - fresh, made-to-order deli sandwiches, salads or wraps
- *Original Burger Company Grill* - OBC serves custom certified angus beef burgers, veggie burgers and grilled chicken sandwiches
- *Pandinis* - individual pizzas, signature Labretti sandwiches, fresh salads and tossed pasta
- *Mein Bowl* - specializing in Chinese favorites, pick from entrees and your choice of noodles, rice or fried rice

WOW at Mountie Grill

Bldg. 19C, Ext. 4624

WOW Cafe and Wingery - breakfast, wings, chicken, hamburgers, salads and rice bowls.

Convenience Stores

All stores offer a variety of snack foods, beverages and school and test supplies.

Mountie Stop

Building 9A

Express Stop

Building 16A

Prime Stop

Building 61

Short Stop

Building 66

Vending Machines

Buildings 2, 3, 9C, 23, 26, 28, 30, 31, 40, 45, 47, 50G, 60, 67, 80

If students have a problem getting food or money returned, they may go the Fiscal Services Office window located on the first floor of Bldg. 4 to complete a form and receive a refund.

Student Services and Resources

Please visit the website or call for current hours of operation

High School Outreach Ext. 5906

Bldg. 9B

www.mtsac.edu/hso

This office coordinates the College's outreach efforts to area high schools. Staff provide regular visitations and specialized presentations to high school students, parents, and high school staff. Matriculation information and assistance are provided to high school students interested in enrolling as new freshmen.

International Student Center Ext. 5032

Bldg. 9B

www.mtsac.edu/international

The International Student Center is available for international students to obtain information regarding services and resources, register for workshops and field trips, meet with study groups or use the computer lab.

The Language Learning Center Ext. 4580

Bldg. 6-264

www.mtsac.edu/instruction/continuinged/noncredit/esl/learning_resources/language_learning_center.html

Provides media and technology to practice foreign languages and English.

Learning Lab

Learning Technology Center, Bldg. 6, South Entrance, First Floor Ext. 5666

www.mtsac.edu/instruction/learning/lac/services.html

The Learning Lab offers free use of PC and MAC computers which have access to the Mt. SAC Library databases, internet, word-processing, spreadsheets, and a variety of course-related software. Registration for the Lab is necessary upon first time use per semester. Students are required to present a current Mt. SAC student photo I.D. at the front desk to access the Lab. Laser printing is available for a fee. A print card dispenser is located in the lab for student convenience. Technical and academic assistance are available for students who need help using a computer or a specific program, setting up access to the student portal, and using databases for research. Workshops are offered on appointment basis to assist students who want more instruction on word-processing, E-mail, database/web research, PowerPoint and course-related materials.

Library

Learning Technology Center, Bldg. 6, North Entrance Ext. 4260

<http://library.mtsac.edu>

The Library offers students, faculty, and staff a place to develop information and technology literacy, cultivate information inquiry skills, engage in quiet study, and meet to collaborate with fellow students. A Mt. SAC ID is needed to use reserve materials such as textbooks in the library and take other library materials out of the library.

Parking Services Ext. 4233

Bldg. 23

www.mtsac.edu/safety

Closed holidays and evening hours during recesses

REACH Program (Foster Youth)

Bldg 9B, 2nd Floor, Room 201

www.mtsac.edu/reach.html

REACH is an educational program designed to assist current and former Foster youth. REACH provides assistance and support to our Foster Youth students in their transition into college, while attending Mt. SAC and as they transfer to a University. We, the REACH program, are committed to be a partner of our Foster Youth students and walk with them side by side in their educational endeavor. Some REACH services offered are mentoring and support, housing resources, priority registration, AB12 (extended foster care) resources, Chafee grant assistance, and much more! Additional information can be found at: www.mtsac.edu/reach.html.

Student Health Services

Ext. 4400

Bldg. 67B

www.mtsac.edu/healthcenter

Medical, chiropractic, personal counseling, nursing, and health education services are provided. Additional services include laboratory tests, tuberculosis screening, limited prescription medications, immunizations, pregnancy testing, and referrals. All credit students who are currently enrolled and attending classes are eligible. Part-time faculty are eligible for select services. Some fees may apply. Professional health services are provided primarily on an appointment basis. Same-day appointments are also available; call between 8:00 and 8:30 a.m. First aid services are provided for all students, employees and guests of the College.

Student Life/Student Activities/

Student Life Center

Ext. 4525

Bldg. 9C

www.mtsac.edu/studentlife

The Student Life Office is responsible for student involvement and leadership programs and serves as the hub of student activities at Mt. SAC. The Associated Students (AS) Government serves as the representative voice for students, while providing students with an opportunity to develop leadership skills. The Student Activities Fee funds many AS activities, sponsored events, and initiatives which support student programs, projects and services throughout the year. Inter-Club Council represents over 45 student clubs and is comprised of one representative from each student club. The Student Life Center provides students a relaxing area to access free wireless internet with their laptops, watch TV, play foosball, ping pong, a variety of board games and video games. Students who are involved in co-curricular activities are encouraged to complete the Activities Transcript (available online) which complements

Student Services and Resources

Please visit the website or call for current hours of operation

their academic transcript and verifies their leadership and service experiences. The Bookstore Office (Bldg. 9A) sells AS discount amusement park and movie tickets. Student Life also oversees an off-campus Housing Referral Program and Lost and Found. All unclaimed items from the previous year are auctioned each September. Students' rights and due process procedures related to student discipline and academic grievances are facilitated through this office.

Tutoring

Mt. SAC offers free tutoring for students in Math, English/Writing and many other subjects.

**Learning Assistance Center (LAC), Learning Technology Center, Bldg. 6, South Entrance, First Floor
Ext. 4300**

<http://lac.mtsac.edu>

The Learning Assistance Center (LAC) offers tutoring, a computer lab, courses in basic Math, Reading, Writing, and study techniques, and testing services for make-up exams. Current Mt. SAC photo I.D. required.

**Math Activities Resource Centers, Math Activities Resource Center (MARC), Bldg. 61 — Room 1318
Ext. 5014**

**Transfer Math Activities Resource Center (T-MARC), Bldg. 61 — Room 1314
Ext. 5389**

www.mtsac.edu/marc

The Math Activities Resource Center (MARC) and Transfer Math Activities Resource Center (T-MARC) offer services including free tutoring, study spaces, tutorial software, calculator rentals, textbooks, solution manuals, and handouts. The MARC serves students in Math 50 to Math 71. The T-MARC serves students in Math 100 and above.

**Tech Ed Resource Center (TERC)
Building 18C, (909) 274-6118 or (909) 274-6122**

The Tech Ed Resource Center (TERC) offers basic math, text book reading, writing, and research methods assistance to all CTE students. Students are encouraged to drop in and work with instructors or study independently. For additional information, please contact TERC at (909) 274-6121 or (909) 274-6122.

**Tutorial Services: Multiple Subjects,
Learning Technology Center, Bldg. 6, South Entrance, First Floor
Ext. 6605**

<http://lac.mtsac.edu>

Tutorial Services offers one-on-one tutoring in multiple subjects, either drop-in or by appointment, as well as study groups and supplemental instruction.

**The Writing Center, Bldg. 26B, Room 1561A
Ext. 5325**

www.mtsac.edu/writingcenter

The Writing Center offers free tutoring, workshops, Directed Learning Activities (DLAs) and a computer lab for all students who would like help with writing. Students need to bring a current Mt. SAC ID to access services.

**Upward Bound-TRiO
Ext. 4411**

Bldg. 9E

Upward Bound is a TRiO program that was established by Congress to help students overcome class, social, academic, and cultural barriers to higher education. The Upward Bound Program is funded by a \$237,438 per year grant from the U.S. Department of Education. Upward Bound is designed to assist high school students from La Puente High School and Ganesha High School who are low-income and/or the first in their family to attend college to pursue and obtain an education at an institution of higher learning. Upward Bound services place emphasis on the development of personal and academic self-confidence through the creation activities during the high school academic year and the summer dual enrollment program. Through Saturday academies, academic tutoring, college trips, Summer Program and other programming participants gain the knowledge and skills necessary to achieve their educational goals and ultimately obtain a bachelor's degree. Alumni and those interested in supporting Upward Bound are welcomed to do so at any time.

**Veterans Resource Center
Ext. 4520**

Bldg. 9E

www.mtsac.edu/veterans/

The Mt. SAC Veterans Resource Center (VRC) offers a wide range of services and programs to support our student Veterans and/or eligible dependents as they navigate the college environment. VRC services include: Vet-to-Vet peer mentoring in the Veterans Lounge; Free tutoring; Access to computer stations/lab; Laptop Rental Program; Emergency Book Loan Program; Book Loan/Reserve Program; FAFSA assistance; Scholarship research/essay assistance; DSP&S Instructional Specialist; Educational/Career counseling; One-on-one VA Educational Benefits assistance; Federal Department of Veterans Affairs Counseling; and on and off-campus service referrals. By offering a "one-stop shop" model, Veterans and their families are able to access assistance and referrals to essential services in a timely manner. For step-by-step instructions in claiming and utilizing educational benefits at Mt. SAC, Veterans and dependents should download the "Veterans Packet" at <http://www.mtsac.edu/veterans/applyforbenefits.html>.

Campus Safety

Services available to help assure your safety include:

- **Police & Campus Safe Escorts** are available to escort you during evening hours, to assure your safety on campus and in parking lots. They are provided at your request, Monday – Thursday, 6:30 p.m. – 10:15 p.m. Police & Campus Safety Escorts can be identified by their yellow shirts and/or jackets and I.D. badges. Please call ext. 4555 or (909) 274-4555 to arrange for assistance.
- **Blue emergency telephone towers** are located throughout the campus and parking lots for you to contact Police & Campus Safety immediately should you need assistance in an emergency.
- **Police & Campus Safety** may be contacted by calling the campus number, (909) 274-4555.
- Call 911 for any emergency or 9-911 when calling from on-campus extensions. Be prepared to identify your exact location.

In addition to contacting the Police & Campus Safety Department, information can also be obtained from the Student Life Office, Bldg. 9C, ext. 4525 or at <http://inside.mtsac.edu>

Campus Emergency Notification System

As part of our continuing effort to provide a safe environment for students and employees, Mt. San Antonio College has a campus-wide emergency notification system. This system enables authorized college personnel to quickly notify students, faculty, and staff about any campus emergency with personalized voice, text and e-mail messages.

In order to execute the process effectively, we need your current contact information and your preferred method of notification. You are able to provide your information on a secured online site at inside.mtsac.edu. Look for the Campus Emergency Notification add/update link. Be assured that your privacy will be protected. Your information will not be shared with anyone or used for any purpose other than for emergency notifications.

Campus Emergency Phone System

Mt. SAC has installed a campus-wide emergency phone system. This system is divided into two primary segments. The inner campus system consists of emergency phones that are placed on the outside of selected campus buildings and are identified by the familiar blue light affixed to the top of the phone housing.

The second segment of emergency phones consists of stand-alone emergency phone towers, located in open campus spaces, primarily in campus parking lots. These phone towers are also identified by a blue light affixed to the top of the tower. Use of any of these emergency phones will connect the user to Police & Campus Safety Department during normal business hours, located in Building 23. During hours when the campus is closed, the emergency phones will connect the user directly to a cell phone carried by Police & Campus Safety Officers who are on duty 24 hours a day, 7 days a week.

Crime Prevention

The Police & Campus Safety Department's primary responsibility is the safety and security of all members of the College community. Every effort is made to inform students and staff of criminal activity or any other concern that may be an immediate threat to the safety and security of those on campus. Information and workshops on crime prevention are made available to College students and staff. It is the responsibility of every member of the campus community to act in ways that promote the safety of self and others and that protect District property.

Police & Campus Safety Enforcement Authority

The Mt. San Antonio College Police & Campus Safety Department has the authority to enforce the Student Discipline Code of Conduct and the State of California Penal Code under Education Code Section 72330. The Mt. San Antonio College Board of Trustees has established the Police & Campus Safety Department as a community college police department under Education Code Section 72330 (a), which authorizes the governing board of a community college district to establish a community college police department under the supervision of a community college chief of police. Although a designated police department, the Mt. San Antonio College Police & Campus Safety Department has a memorandum of understanding mandated by the "Crime Awareness and Campus Safety Act of 1990," that the Los Angeles County Sheriff's Department has jurisdiction to investigate all crimes occurring on Mt. San Antonio College Campus.

Campus Safety

Annual Security Report

In compliance with the Clery Act, the College publishes an annual security report which contains information regarding campus crime statistics. This information may be found on the website below. Copies of the annual report can be obtained from the Police & Campus Safety Department, Building 23. The Police & Campus Safety Crime Log is maintained in the Department of Police & Campus Safety office. Brochures on Emergency Procedures are available throughout the campus.

<http://www.mtsac.edu/safety/pdf/2015-Annual-Security-Report-final.pdf>

POLICE & CAMPUS SAFETY DEPARTMENT STATISTICAL CRIME REPORT YTD TOTALS

VIOLATION	2013	2014	2015
Robbery	0	0	1
Aggravated Assault	2	1	1
Burglary	14	12	10
Motor Vehicle Theft (GTA)	12	5	4
Arson	1	0	0
Dating Violence	NR	0	0
Domestic Violence	NR	2	0
Stalking	NR	0	1

*NR means the statistic was not required by the Clery Act in a particular year.

Reporting Crimes & Emergencies

Students and staff should report serious crimes and emergencies, i.e., fire/medical, occurring on campus to the Police & Campus Safety Department or call **911**. When using an on-campus extension, call 9-911. Incidents may be reported to Police & Campus Safety by calling **(909) 274-4555**, 24 hours a day, seven days a week. Police & Campus Safety may also be contacted during and after business hours from public telephone locations on campus by dialing ***-91**. In the event of an emergency, students and staff are requested to make a prompt and accurate report to the Police & Campus Safety Department. The Police & Campus Safety Department is located at the southeast portion of the campus off Bonita Drive in Building 23.

2018 SPRING SCHEDULE of CLASSES

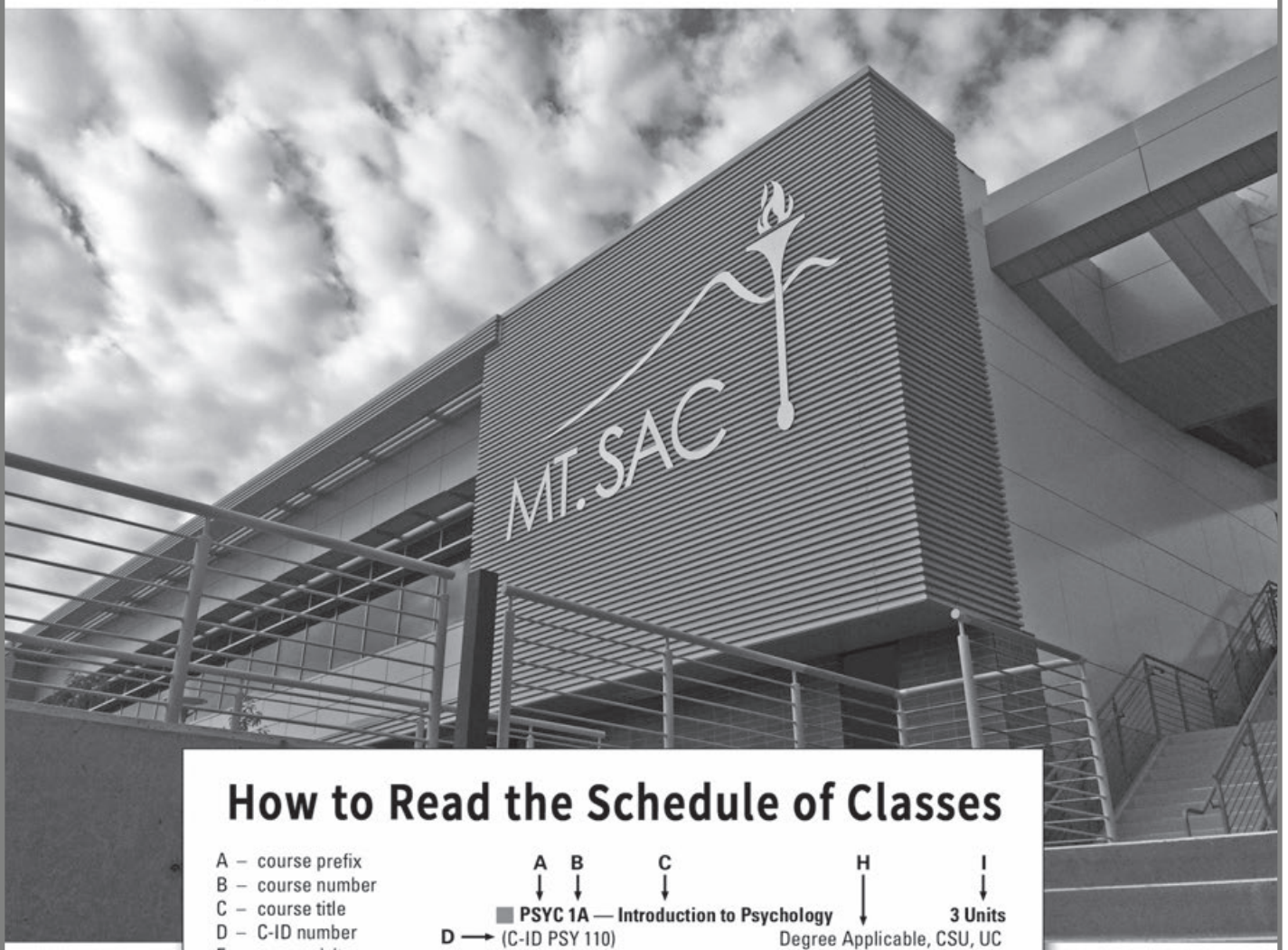

How to Read the Schedule of Classes

- A – course prefix
- B – course number
- C – course title
- D – C-ID number
- E – prerequisite
- F – advisory
- G – course description
- H – transfer code
- I – number of units
- J – course reference number (CRN)
- K – days class meets
- L – time class meets
- M – name of professor
- N – building number
- O – room number

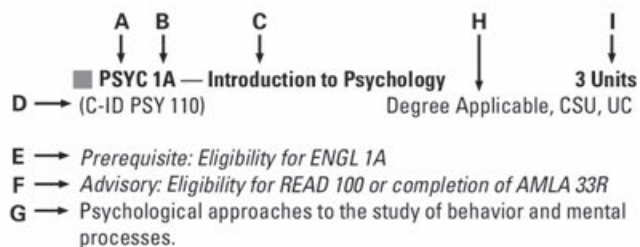

20516 TTh
9:45am - 11:10am
Bacigalupi, S
26A-2811

↑ J
↑ K
↑ L
↑ M
↑ N
↑ O

Note: 12:00 p.m. is Noon

The schedule below is intended to provide professors a 2 hour time period for final exams. **Final exams are required in all courses for all students.** Permission to schedule a final exam at a time other than the time it is regularly scheduled must be secured at least one week in advance of any change. The professor may not change the scheduled time for the final exam without authorization from his or her division dean. **The student should consider the final exam schedule before selecting semester courses.** Final exams are given in the same classroom in which classes meet regularly. Double-period classes meet according to the first day in the week that the class meets and according to the first period in the day the class meets. All Friday final exams between 4:00 and 7:00 p.m. will be held on Friday, June 15. **Saturday and Sunday classes will conduct final exams on June 16 and 17 at the same time the classes regularly meet.** Short-term classes will conduct final exams during the last class meeting. Afternoon and evening classes are shaded below.

	Monday, June 11	Tuesday, June 12	Wednesday, June 13	Thursday, June 14	Friday, June 15
7:30 a.m. - 10:00 a.m.	M 8:00-11:10am M 8:30-11:40am M 8:00-12:15pm M 9:00-1:15pm MW 6:45-7:50am MW 6:55-8:20am MW 7:00-9:30am MW 7:30-8:35am MW 7:30-9:35am MW 8:00-9:25am MW 8:00-10:30am MW 8:15-9:20am MW 8:30-9:55am MW 8:30-10:35am MW 8:45-9:50am MWF 7:00-8:15am MWF 7:30-9:05am MWF 8:00-9:15am MWF 8:00-9:35am MWF 8:30-9:45am 4 days 7:30-8:40am 4 days 8:30-9:40am	T 8:00-11:10am T 8:30-11:40am T 8:00-12:15pm T 9:00-1:15pm TTh 6:45-7:50am TTh 6:55-8:20am TTh 7:00-9:30am TTh 7:30-8:35am TTh 7:30-9:35am TTh 8:00-9:25am TTh 8:00-10:30am TTh 8:15-9:20am TTh 8:30-9:55am TTh 8:30-10:35am TTh 8:45-9:50am TThF 7:00-8:15am TThF 7:30-9:05am TThF 8:00-9:15am TThF 8:00-9:35am TThF 8:30-9:45am	W 8:00-11:10am W 8:30-11:40am W 8:00-12:15pm W 9:00-1:15pm MW/WF 9:30-10:35am MW/WF 9:30-10:45am MW/WF 9:45-11:10am MW/WF 9:45-11:50am MW/WF 9:45-12:15pm MW/WF 10:00-11:05am MW/WF 10:00-11:15am MW/WF 10:15-11:40am MW/WF 10:45-11:50am MW/WF 10:45-12:50pm MW/WF 10:45-1:15pm MWF 9:15-10:50am MWF 9:45-11:20am 4 days 9:00-10:10am 4 days 10:00-11:10am 4 days 10:30-11:40am	Th 8:00-11:10am Th 8:30-11:40am Th 8:00-12:15pm Th 9:00-1:15pm TTh 9:30-10:35am TTh 9:30-10:45am TTh 9:45-11:10am TTh 9:45-11:50am TTh 9:45-12:15pm TTh 10:00-11:05am TTh 10:00-11:15am TTh 10:15-11:40am TTh 10:45-11:50am TTh 10:45-12:50pm TTh 10:45-1:15pm TThF 9:15-10:50am TThF 9:45-11:20am	F 8:00-11:10am F 8:30-11:40am F 8:00-12:15pm F 9:00-1:15pm WF 6:45-7:50am WF 7:00-9:30am WF 7:30-8:35am WF 8:15-9:20am WF 8:45-9:50am WF 8:00-10:30am
10:30 a.m. - 1:00 p.m.	M 11:30-2:40pm M 12:00-3:10pm MW 11:00-12:15pm MW 11:15-12:20pm MW 11:30-12:45pm MW 11:30-12:55pm MW 12:00-1:05pm MW 12:00-1:25pm MW 12:00-2:05pm MWF 11:00-12:35pm MWF 11:30-1:05pm 4 days 11:30-12:40pm 4 days 12:00-1:10pm	T 11:30-2:40pm T 12:00-3:10pm TTh 11:00-12:15pm TTh 11:15-12:20pm TTh 11:30-12:45pm TTh 11:30-12:55pm TTh 12:00-1:05pm TTh 12:00-1:25pm TTh 12:00-2:05pm TThF 11:00-12:35pm TThF 11:30-1:05pm	W 11:30-2:40pm W 12:00-3:10pm MW/WF 12:30-1:35pm MW/WF 12:30-1:45pm MW/WF 12:30-3:00pm MWF 12:45-2:20pm	Th 11:30-2:40pm Th 12:00-3:10pm TTh 12:30-1:35pm TTh 12:30-1:45pm TTh 12:30-3:00pm TThF 12:45-2:20pm	F 11:30-2:40pm F 12:00-3:10pm WF 11:00-12:15pm WF 11:15-12:20pm WF 11:30-12:45pm WF 11:30-12:55pm WF 12:00-1:05pm WF 12:00-1:25pm WF 12:00-2:05pm
1:30 p.m. - 4:00 p.m.	M 1:30-5:45pm MW 1:00-3:05pm MW 1:15-2:20pm MW 1:15-2:40pm MW 1:45-2:50pm MW 1:30-4:00pm MW 1:45-3:10pm MW 2:15-4:20pm MWF 1:00-2:15pm MWF 1:15-2:50pm MWF 2:00-3:15pm 4 days 1:00-2:10pm 4 days 1:30-2:40pm	T 1:30-5:45pm TTh 1:00-3:05pm TTh 1:15-2:20pm TTh 1:15-2:40pm TTh 1:45-2:50pm TTh 1:45-3:10pm TTh 2:15-4:20pm TTh 1:30-4:00pm TThF 1:00-2:15pm TThF 1:15-2:50pm TThF 2:00-3:15pm	W 1:30-5:45pm MW/WF 2:30-3:35pm MW/WF 3:00-4:05pm MW/WF 3:00-4:25pm MW/WF 3:15-5:20pm MW/WF 3:30-4:55pm MWF 2:30-3:45pm MWF 2:30-4:05pm MWF 3:00-4:35pm MWF 3:30-4:45pm 4 days 2:30-3:40pm 4 days 3:00-4:10pm	Th 1:30-5:45pm TTh 2:30-3:35pm TTh 3:00-4:05pm TTh 3:00-4:25pm TTh 3:30-4:55pm TTh 3:15-5:20pm TThF 2:30-3:45pm TThF 2:30-4:05pm TThF 3:00-4:35pm TThF 3:30-4:45pm	F 1:30-5:45pm WF 1:00-3:05pm WF 1:15-2:20pm WF 1:15-2:40pm WF 1:45-2:50pm WF 1:30-4:00pm WF 1:45-3:10pm WF 2:15-4:20pm
4:30 p.m. - 7:00 p.m.	M 3:00-6:10pm M 3:30-6:40pm MW 3:15-5:45pm MW 3:45-4:50pm MW 4:15-5:20pm MW 4:15-6:45pm MW 4:30-6:35pm MW 4:45-6:10pm MWF 4:00-5:15pm MWF 4:15-5:50pm MWF 4:45-6:20pm 4 days 4:00-5:10pm 4 days 4:30-5:40pm	T 3:00-6:10pm T 3:30-6:40pm TTh 3:15-5:45pm TTh 3:45-4:50pm TTh 4:15-5:20pm TTh 4:15-6:45pm TTh 4:30-6:35pm TTh 4:45-6:10pm TThF 4:00-5:15pm TThF 4:15-5:50pm TThF 4:45-6:20pm	W 3:00-6:10pm W 3:30-6:40pm MW 5:00-6:05pm MW 5:15-6:40pm MW 5:30-6:35pm MW 5:30-7:35pm WF 4:15-6:45pm WF 4:30-6:35pm WF 4:45-6:10pm WF 5:15-6:40pm WF 5:30-7:35pm MWF 5:00-6:15pm MWF 5:30-6:45pm 4 days 5:30-6:40pm	Th 3:00-6:10pm Th 3:30-6:40pm TTh 5:00-6:05pm TTh 5:15-6:40pm TTh 5:30-6:35pm TTh 5:30-7:35pm TThF 5:30-6:45pm TThF 5:00-6:15pm	F 3:00-6:10pm F 3:30-6:40pm WF 3:15-5:45pm WF 3:45-4:50pm WF 4:15-5:20pm
7:30 p.m. - 10:00 p.m.	M 5:00-9:15pm M 6:00-10:15pm M 6:30-9:40pm M 7:00-10:10pm MW 6:00-8:30pm MW 6:15-7:20pm MW 6:30-7:55pm MW 6:45-7:50pm MW 6:45-8:50pm MW 7:00-8:25pm MW 7:00-9:30pm MWF 6:00-7:35pm MWF 6:30-8:05pm MWF 6:30-7:45pm MWF 7:00-8:15pm 4 days 6:00-7:10pm 4 days 7:00-8:10pm	T 5:00-9:15pm T 6:00-10:15pm T 6:30-9:40pm T 7:00-10:10pm TTh 6:00-8:30pm TTh 6:15-7:20pm TTh 6:30-7:55pm TTh 6:45-7:50pm TTh 6:45-8:50pm TTh 7:00-8:25pm TTh 7:00-9:30pm TThF 6:00-7:35pm TThF 6:30-8:05pm TThF 6:30-7:45pm TThF 7:00-8:15pm	W 5:00-9:15pm W 6:00-10:15pm W 6:30-9:40pm W 7:00-10:10pm MW/WF 7:30-8:35pm MW/WF 7:45-9:50pm MW/WF 8:00-9:05pm MW/WF 8:15-9:40pm MW/WF 8:45-10:10pm MW/WF 8:45-9:50pm WF 6:00-8:30pm WF 7:00-9:30pm MWF 7:45-9:20pm MWF 8:00-9:15pm MWF 8:15-9:50pm MWF 8:30-9:45pm 4 days 7:30-8:40pm 4 days 8:30-9:40pm	Th 5:00-9:15pm Th 6:00-10:15pm Th 6:30-9:40pm Th 7:00-10:10pm TTh 7:30-8:35pm TTh 7:45-9:50pm TTh 8:00-9:05pm TTh 8:15-9:40pm TTh 8:45-10:10pm TTh 8:45-9:50pm TThF 7:45-9:20pm TThF 8:00-9:15pm TThF 8:15-9:50pm TThF 8:30-9:45pm	F 5:00-9:15pm F 6:00-10:15pm F 6:30-9:40pm F 7:00-10:10pm WF 6:15-7:20pm WF 6:30-7:55pm WF 6:45-7:50pm WF 6:45-8:50pm WF 7:00-8:25pm

Course Offerings

February 26 - June 17

Administration of Justice: Law Enforcement	34	Geography	95
Aeronautics	35	Geology	96
Agriculture: Animal Health Technology	35	German	97
Agriculture: Animal Science General	36	History	97
Agriculture: General Subjects	36	Histotechnology	99
Agriculture: Livestock Production	37	Honors Program	100
Agriculture: Ornamental Horticulture	37	Honors Program Application	101
Agriculture: Pet Science	38	Hospitality and Restaurant Management	100
Air Conditioning and Refrigeration	38	Humanities	103
Air Traffic Control	39	Industrial Design Engineering	103
Aircraft Maintenance Technology	40	Interior Design	104
Alcohol Drug Counseling	40	Italian	105
American Language	41	Japanese	106
Anatomy and Physiology	42	Journalism	106
Anthropology	43	Kinesiology: Adaptive	107
Arabic	44	Kinesiology: Aquatics	107
Architectural Technology	44	Kinesiology: Athletics	107
Art: Animation	45	Kinesiology: Fitness	109
Art: Basic Studio Arts	46	Kinesiology: Individual	112
Art: Gallery and Professional Practices	46	Kinesiology: Team Sport	113
Art: Graphic Design and Illustration	46	Kinesiology: Theory	114
Art: Three-Dimensional Studio Arts	47	Latin	116
Art: Two-Dimensional Studio Arts	48	Leadership	116
Art History	50	Learning Assistance	116
Astronomy	51	Learning Communities	117
Biology	52	Library and Instructional Media	117
Botany	54	Manufacturing Technology	117
Business: Accounting	54	Mathematics	118
Business: Business Communications	56	Mathematics Course Sequences	119
Business: Economics	57	Mathematics Bridge Program	122
Business: Law	57	Medical Terminology	125
Business: Management	58	Mental Health/Psychiatric Technician	125
Business: Real Estate	60	Meteorology	126
Business: Sales, Merchandising, and Marketing	60	Microbiology	126
Chemistry	61	Music	126
Child Development	62	Nursing	130
Chinese	66	Nutrition and Food	133
Computer Information Systems: Beginning	66	Oceanography	136
Computer Information Systems: Database	68	Paralegal	136
Computer Information Systems: Management	69	Philosophy	137
Computer Information Systems: Networking	69	Photography	141
Computer Information Systems: Programming	71	Physical Science	142
Computer Information Systems: Security	73	Physics	142
Computer Information Systems: Web Applications	74	Political Science	143
Computer Science	75	Psychology	144
Computer and Networking Technology	75	Public Health	148
Counseling	75	Radio - Television	148
Dance: Activity	76	Radiologic Technology	149
Dance: Theory	79	Reading	150
Disabled Students	79	Respiratory Therapy	151
Education	79	Sign Language, Interpreting	151
Electronics	79	Sociology	153
Emergency Medical Service	80	Spanish	157
Emergency Medical Technician	80	Speech	158
Engineering	80	Study Techniques	159
Engineering Construction Tech	81	Surveying	159
Engineering Design Technology	81	Technology-Related Courses	159
English: Composition	82	Theater Arts	159
English Bridge Program	88	Welding	160
English: Literature	91		
Family and Consumer Sciences	92	Distance Learning Program	162
Fashion Merchandising and Design	93	Distance Learning Program: Online Courses	162
Fire Technology	94	Distance Learning Program:	
French	94	Online-Supported (Hybrid) Courses	163
		Short-Term Credit Classes	164

2018 Spring Schedule of Classes

ADMINISTRATION OF JUSTICE: LAW ENFORCEMENT

■ ADJU 1 — The Administration of Justice System 3.0 Units (C-ID AJ 110) Degree Applicable, CSU, UC

History and philosophy of the justice system, subsystems, roles, relationships and theories of crime causation and correction.

41398	T	11:30am - 2:40pm	Jefferson, P	28B-104
41547	Th	11:30am - 2:40pm	Jefferson, P	28B-104
41399		arrange 3.38 hours	Jefferson, P	ONLINE

NOTE: CRN 41399 Is a Distant Learning Class.

How to Begin Course: Log into Canvas through <http://myportal.msac.edu> and click CRN for you DL course. **NOTE:** Some courses may not be activated until the start of the term. If you cannot locate your DL course in Canvas when the term starts, contact the professor. On the first day of classes, log into your DL course to show your "attendance" because not doing so could result in your being dropped from the class for non-attendance.

Professor contact info: Email Professor Jefferson at either: pjefferson@mtsac.edu, through Student Detail Schedule or Canvas at MyMt-SAC Portal.

Students must use their Mt. SAC e-mail account and be aware of course commitment and student expectations described at <http://www.mtsac.edu/instruction/learning/distlearn/> To prepare for a successful online learning experience, see helpful short videos <http://www.mtsac.edu/distancelearning/quiz/>

41501		arrange 3.38 hours	Jefferson, P	ONLINE
-------	--	--------------------	--------------	--------

NOTE: CRN 41501 Is a Distant Learning Class.

How to Begin Course: Log into Canvas through <http://myportal.msac.edu> and click CRN for you DL course. **NOTE:** Some courses may not be activated until the start of the term. If you cannot locate your DL course in Canvas when the term starts, contact the professor. On the first day of classes, log into your DL course to show your "attendance" because not doing so could result in your being dropped from the class for non-attendance.

Professor contact info: Email Professor Jefferson at either: pjefferson@mtsac.edu, through Student Detail Schedule or Canvas at MyMt-SAC Portal.

Students must use their Mt. SAC e-mail account and be aware of course commitment and student expectations described at <http://www.mtsac.edu/instruction/learning/distlearn/> To prepare for a successful online learning experience, see helpful short videos <http://www.mtsac.edu/distancelearning/quiz/>

■ ADJU 2 — Principles and Procedures of the Justice System 3.0 Units (C-ID AJ 122) Degree Applicable, CSU

Due process in criminal proceedings from pre-arrest through trial and appeal using statutory law and legal precedent.

41401	M	11:30am - 2:40pm	Jefferson, P	28B-104
41400	W	11:30am - 2:40pm	Jefferson, P	28B-104
44250	T	6:30pm - 9:40pm	Sweet, W	28B-204

■ ADJU 3 — Concepts of Criminal Law 3.0 Units (C-ID AJ 120) Degree Applicable, CSU, UC

Classification of crime, elements of crimes, common and statutory law, and evidence as observed through the study of case law.

41403	M	8:00am - 10:35am	Heard, L	28B-204
	and M	10:45am - 12:15pm	Heard, L	28B-204
41404	W	8:00am - 10:35am	Heard, L	28B-204
	and W	10:45am - 12:15pm	Heard, L	28B-204
44251	M	6:00pm - 8:35pm	Sweet, W	28B-210
	and M	8:45pm - 10:15pm	Sweet, W	28B-210

■ ADJU 4 — Legal Aspects of Evidence 3.0 Units (C-ID AJ 124) Degree Applicable, CSU

Criminal evidence: admissibility, privileged communication, hearsay, and collection and preservation of evidence.

41406	Th	8:00am - 11:10am	Heard, L	28B-212
41407	Th	1:45pm - 4:55pm	Heard, L	28B-204

■ ADJU 5 — Community Relations 3.0 Units (C-ID AJ 160) Degree Applicable, CSU, UC

Examines the complex relationship between communities and the justice system: crime and conflict within diverse neighborhoods.

41499	Th	11:30am - 2:40pm	Ellis, R	28B-212
41408	W	6:30pm - 9:40pm	Ellis, R	28B-212

■ ADJU 6 — Concepts of Enforcement Services 3.0 Units Degree Applicable

Responsibilities, techniques, and methods of police patrol and handling common police occurrences.

41541	Th	3:00pm - 6:10pm	Smith, K	28B-212
-------	----	-----------------	----------	---------

■ ADJU 9 — Introduction to Homeland Security 3.0 Units Degree Applicable, CSU

Homeland security including the role of first responders to threats and events through theories, concepts, and case studies.

41553	Th	6:30pm - 9:40pm	Smith, K	28B-212
-------	----	-----------------	----------	---------

■ ADJU 10 — Introduction to Correctional Sciences 3.0 Units Degree Applicable, CSU

The philosophy behind past and present practices used in the criminal justice and correctional processes.

41552	T	6:30pm - 9:40pm	Henderson-Lewis, D	28B-212
-------	---	-----------------	--------------------	---------

■ ADJU 20 — Principles of Investigation 3.0 Units (C-ID AJ 140) Degree Applicable, CSU

Principles of investigatory procedures. 4th Amendment issues, profiling, interrogation, and use of informants.

41502	M	8:00am - 10:35am	Bone, D	28B-212
	and M	10:45am - 12:15pm	Bone, D	28B-212
41402	W	6:00pm - 8:35pm	Bone, D	28B-204
	and W	8:45pm - 10:15pm	Bone, D	28B-204

■ ADJU 38 — Narcotics Investigation 3.0 Units Degree Applicable

Investigation and arrest techniques for drug enforcement.

41405	M	6:30pm - 9:40pm	Yagoda, M	28B-212
-------	---	-----------------	-----------	---------

■ ADJU 50 — Introduction to Forensics for Criminal Justice 3.0 Units (C-ID AJ 150) Degree Applicable, CSU

Collecting, preserving, and analyzing physical evidence in criminal cases.

41504	W	9:00am - 11:35am	Yagoda, M	28B-212
	and W	11:45am - 1:15pm	Yagoda, M	28B-212
41580	Th	9:00am - 11:35am	Yagoda, M	28B-204
	and Th	11:45am - 1:15pm	Yagoda, M	28B-204
41505	M	6:00pm - 8:35pm	Martinez, J	28B-204
	and M	8:45pm - 10:15pm	Martinez, J	28B-204

■ ADJU 59 — Gangs and Corrections 3.0 Units Degree Applicable, CSU

Contemporary gang issues including street and prison gang dynamics, characteristics, and role of law enforcement and corrections.

41410	F	8:00am - 11:10am	Meredith, D	28B-212
41409	W	6:30pm - 9:40pm	Meredith, D	28B-210

■ ADJU 68 — Administration of Justice Report Writing 3.0 Units Degree Applicable

Prerequisite: Eligibility for ENGL 1A

Techniques for proper documentation of crime reports and related law enforcement records. Use of simulations and role-playing.

41411	T	8:00am - 10:35am	Heard, L	28B-204
	and T	10:45am - 12:15pm	Heard, L	28B-204

■ **ADJU 90 — Work Experience in Administration of Justice** 1.0 Unit
Not Degree Applicable

(May be taken for Pass/No Pass Only)

Prerequisite: Prior approval by ADJU department faculty and compliance with Work Experience regulations as designated in the College Catalog

41516 arrange 4.69 hours Jefferson, P 18C

■ **ADJU 90 — Work Experience in Administration of Justice** 2.0 Units
Not Degree Applicable

(May be taken for Pass/No Pass Only)

Prerequisite: Prior approval by ADJU department faculty and compliance with Work Experience regulations as designated in the College Catalog

41517 arrange 9.38 hours Jefferson, P 28B

AERONAUTICS

■ **AERO 100 — Primary Pilot Ground School** 4.0 Units
Degree Applicable, CSU

Meets the preparation requirements for the FAA Private Pilot knowledge examination and FAA Air Traffic Control Basics.

41413 MW 8:30am - 10:35am Rogus, L 28B-107

41412 TTh 8:30am - 10:35am Rogus, L 28B-107

41414 T 6:00pm - 10:15pm Calverley, R 28B-107

■ **AERO 102 — Aviation Weather** 3.0 Units
Degree Applicable, CSU

Weather elements and evaluation of aviation weather reports and forecasts.

41418 T 12:00pm - 3:10pm Shackelford, S 28B-103

44304 Th 12:00pm - 3:10pm Isaacs, G 28B-107

41419 W 7:00pm - 10:10pm Shackelford, S 28B-103

■ **AERO 104 — Federal Aviation Regulations** 2.0 Units
Degree Applicable, CSU

Federal Aviation Regulations (FAR) pertaining to pilot certification, aircraft maintenance, and general operating rules.

41423 MW 12:00pm - 2:05pm Rogus, L 28B-107

8 Weeks, Week beginning 02/26/2018 ending 04/22/2018

44305 MW 12:00pm - 2:05pm Rogus, L 28B-107

8 Weeks, Week beginning 04/23/2018 ending 06/17/2018

41422 Th 4:00pm - 6:05pm Todd, D 28B-107

■ **AERO 150 — Commercial Pilot Ground School** 3.0 Units
Degree Applicable, CSU

Advisory: AERO 23 or AERO 100

Prepares students for completion of Federal Aviation Administration (FAA) Commercial Pilot Computerized Knowledge Examination.

41417 TTh 8:30am - 9:55am Rogus, R 28B-103

41581 M 6:30pm - 9:40pm Rogus, R 28B-103

■ **AERO 152 — Air Transportation** 3.0 Units
Degree Applicable, CSU

Air transportation industry, structure and economics of airlines, aviation career planning.

41575 MW 6:55am - 8:20am Tracey, M 28B-103

41430 M 6:30pm - 9:40pm Tracey, M 28B-107

■ **AERO 200 — Aviation Safety and Human Factors** 3.0 Units
Degree Applicable, CSU

Advisory: AERO 23 or AERO 100

Evaluation and analysis of factors leading to aircraft accidents.

41420 M 12:00pm - 3:10pm Fleming, J 28B-103

■ **AERO 202 — Aircraft and Engines** 3.0 Units
Degree Applicable, CSU

Advisory: AERO 100 or AERO 23

Aircraft and engine design, subsystems and maintenance.

41421 W 3:30pm - 6:40pm Calverley, R 28B-107

■ **AERO 206L — Flight Simulator Laboratory** .5 Unit
Degree Applicable

(May be taken for Pass/No Pass Only)

Advisory: AERO 25 or AERO 150

Flight simulator training in the iGATE PC-ATD simulator in preparation for the instrument rating.

41520 W 12:00pm - 3:10pm STAFF 28B-103

8 Weeks, Week beginning 04/23/2018 ending 06/17/2018

■ **AERO 250 — Navigation** 3.0 Units
Degree Applicable, CSU

Advisory: AERO 23 or AERO 100

Navigation concepts and their application in cross-country flying.

41415 MW 8:30am - 9:55am Rogus, R 28B-103

41416 TTh 10:15am - 11:40am Rogus, R 28B-103

■ **AERO 252 — Instrument Ground School** 3.0 Units
Degree Applicable, CSU

Advisory: (AERO 23 or AERO 100) and (AERO 26 or AERO 102)

Meets the preparation requirements for FAA Instrument Pilot knowledge exam.

41424 MW 10:15am - 11:40am Rogus, R 28B-103

41425 W 7:00pm - 10:10pm Calverley, R 28B-107

■ **AERO 256 — Flight Instructor Ground School** 3.0 Units
Degree Applicable

Advisory: (AERO 25 or AERO 150) and (AERO 30 or AERO 252)

Prepares students for Federal Aviation Administration (FAA) knowledge tests for Flight Instructors.

44306 Th 6:30pm - 9:40pm Todd, D 28B-107

■ **AERO 258 — Multi-Engine Turbine Aircraft Operations** 3.0 Units
Degree Applicable

Advisory: (AERO 23 or AERO 100) and (AERO 30 or AERO 252)

Design features and operational characteristics of a selected multi-engine turbine aircraft. Off-campus trips maybe required.

41521 T 12:00pm - 3:10pm Fleming, J 28B-107

AGRICULTURE: ANIMAL HEALTH TECHNOLOGY

■ **AGHE 54 — Veterinary Office Procedures** 3.0 Units
Degree Applicable, CSU

Prerequisite: Eligibility for ENGL 1A

Veterinary medical records, client relations, medical terminology, filing reports, legal responsibilities, and veterinary ethics.

41627 W 12:00pm - 3:10pm Waters, D 80-1451

41617 M 3:30pm - 4:55pm Smith, J 80-1451

and M 5:15pm - 6:40pm Smith, J 80-1451

■ **AGHE 60 — Medical Nursing and Animal Care** 4.0 Units
Degree Applicable, CSU

Prerequisite: AGHE 86 and AGHE 64 and Formal admittance to the Registered Veterinary Technology program

Corequisite: AGHE 62A (may have been taken previously)

41609 M 8:30am - 11:40am Uyeno, G 80-1250

and M 12:00pm - 3:10pm Uyeno, G 80-1250

■ **AGHE 61 — Animal Surgical Nursing** 4.0 Units
Degree Applicable, CSU

Prerequisite: AGHE 60 and formal admittance to the Registered Veterinary Technology Program

Corequisite: AGHE 62B

41610 T 8:30am - 11:40am Uyeno, G 80-1250

and T 12:00pm - 3:10pm Uyeno, G 80-1250

41611 W 8:30am - 11:40am Uyeno, G 80-1250

and W 12:00pm - 3:10pm Uyeno, G 80-1250

■ AGHE 62A — Clinical Pathology		4.0 Units	
Degree Applicable, CSU			
<i>Prerequisite: AGHE 86 and Formal Admittance to the Registered Veterinary Technology Program</i>			
Hematology, clinical chemistries, internal parasites, immunology, serology, and vaginal cytology of domestic animals.			
44111	Th	8:30am - 11:40am	Barnes, N 80-1250
	and Th	12:00pm - 3:10pm	Barnes, N 80-1250
41615	M	3:30pm - 6:40pm	Uyeno, G 80-1250
	and M	7:00pm - 10:10pm	Uyeno, G 80-1250

■ AGHE 62B — Clinical Pathology		4.0 Units	
Degree Applicable, CSU			
<i>Prerequisite: AGHE 86 and Formal Admittance to the Registered Veterinary Technology Program</i>			
Bacteriology, clinical chemistry, urinalysis, external parasites and cytology of domestic animals.			
41616	T	3:30pm - 6:40pm	Uyeno, G 80-1250
	and T	7:00pm - 10:10pm	STAFF 80-1250
44112	W	3:30pm - 6:40pm	Barnes, N 80-1250
	and W	7:00pm - 10:10pm	Barnes, N 80-1250

■ AGHE 64 — Veterinary Pharmacology		3.0 Units	
Degree Applicable, CSU			
<i>Prerequisite: AGHE 86 and (MATH 71, MATH 71B, or MATH 71X)</i>			
Pharmaceuticals and biologics commonly used in the maintenance of animal health.			
41612	M	8:30am - 11:40am	Padilla, M 80-1451
41613	T	12:00pm - 3:10pm	Padilla, M 80-1451
44742	T	6:30pm - 9:40pm	Barnes, N 80-1240

■ AGHE 65 — Veterinary Radiography		2.0 Units	
Degree Applicable, CSU			
<i>Prerequisite: AGHE 86 and formal admittance to the registered veterinary technology program</i>			
41608	F	8:45am - 9:50am	Padilla, M 80-1250
	and F	10:15am - 1:25pm	Padilla, M 80-1250
41639	W	3:30pm - 4:35pm	Padilla, M 80-1451
	and W	4:45pm - 7:55pm	Padilla, M 80-1451

■ AGHE 79 — Laboratory Animal Medicine and Care		3.0 Units	
Degree Applicable, CSU			
41606	Th	9:00am - 11:05am	Padilla, M 80-1421
	and Th	11:30am - 2:40pm	Padilla, M 80-1421

■ AGHE 83A — Work Experience in Animal Health		2.0 Units	
Degree Applicable, CSU			
(May be taken for Pass/No Pass Only)			
<i>Prerequisite: AGAN 51 and Compliance with Work Experience regulations as designated in the College Catalog</i>			
41636	arrange	9.4 hours	Padilla, M 80-2301B

■ AGHE 83A — Work Experience in Animal Health		1.0 to 4.0 Units	
Degree Applicable, CSU			
(May be taken for Pass/No Pass Only)			
<i>Prerequisite: AGAN 51 and Compliance with Work Experience regulations as designated in the College Catalog</i>			
41629	arrange	4.7 hours	Padilla, M 80-2301B
41630	arrange	4.7 hours	Waters, D 80-2301E

■ AGHE 84B — Applied Animal Health Procedures		1.0 Unit	
Degree Applicable			
<i>Prerequisite: Formal Admittance to the Registered Veterinary Technology Program</i>			
41605	Th	12:00pm - 3:10pm	Lopez, A 80-1431

■ AGHE 86 — Anatomy and Physiology of Domestic Animals		4.0 Units	
Degree Applicable, CSU			
<i>Advisory: BIOL 1</i>			
41607	Th	8:30am - 11:40am	Waters, D 80-1451
	and Th	12:00pm - 3:10pm	Waters, D 80-1451
41614	T	3:30pm - 6:40pm	Waters, D 80-1451
	and T	7:00pm - 10:10pm	Waters, D 80-1451

AGRICULTURE: ANIMAL SCIENCE GENERAL

■ AGAN 1 — Animal Science		3.0 Units	
Degree Applicable, CSU, UC			
A scientific approach to the livestock industry. Field trips may be required.			
41819	M	8:30am - 11:40am	Pepper, S 80-1220
41625	T	8:30am - 11:40am	Pepper, S 80-1451
41624	W	6:30pm - 9:40pm	Phillips, J 80-1240

■ AGAN 2 — Animal Nutrition		3.0 Units	
Degree Applicable, CSU, UC			
41816	Th	8:30am - 11:40am	Lopez, A 80-1431
41622	T	11:30am - 2:40pm	Lopez, A 80-1431
41638	W	11:30am - 2:40pm	Lopez, A 80-1431
41623	W	5:15pm - 8:25pm	Lopez, A 80-1431

■ AGAN 51 — Animal Handling and Restraint		3.0 Units	
Degree Applicable, CSU			
Method of handling for large and small animals, including chemical and physical techniques of restraint. Field trip required.			
41620	F	9:00am - 11:05am	Phillips, J 80-1240
	and F	11:30am - 2:40pm	Phillips, J 80-1240
41618	M	9:30am - 11:35am	Barnes, N 80-1240
	and M	11:45am - 2:55pm	Barnes, N 80-1240
41619	Th	9:30am - 11:35am	Phillips, J 80-1240
	and Th	11:45am - 2:55pm	Phillips, J 80-1240

■ AGAN 94 — Animal Breeding		3.0 Units	
Degree Applicable			
44121	W	12:00pm - 3:10pm	Hoffman, A 80-1220
41621	F	3:00pm - 6:10pm	Phillips, J 80-1240

AGRICULTURE: GENERAL SUBJECTS

■ AGAG 1 — Food Production, Land Use, and Politics - A Global Perspective		3.0 Units	
Degree Applicable, CSU, UC			
Surveys the world's food producing systems in terms of economic, political, and cultural forces.			
41599	M	6:00pm - 9:10pm	Hinostroza, J 80-1331
44252	arrange	3.4 hours	Perea, C ONLINE

■ AGAG 59 — Work Experience in Agriculture		1.0 Unit	
Degree Applicable			
(May be taken for Pass/No Pass Only)			
<i>Prerequisite: Compliance with Work Experience regulations as designated in the College Catalog</i>			
41635	arrange	4.7 hours	Pepper, S 80

■ AGAG 59 — Work Experience in Agriculture		2.0 Units	
Degree Applicable			
(May be taken for Pass/No Pass Only)			
<i>Prerequisite: Compliance with Work Experience regulations as designated in the College Catalog</i>			
41641	arrange	9.4 hours	Pepper, S 80

AGRICULTURE: LIVESTOCK PRODUCTION

■ AGLI 17 — Sheep Production 3.0 Units

Degree Applicable, CSU

Survey of the sheep and goat industries; including the basic care of small ruminants. Laboratory and field trips required.

44747	T	11:30am - 1:35pm	STAFF	80-1421
and	T	1:45pm - 4:55pm	STAFF	80-1421

■ AGLI 18 — Horse Ranch Management 4.0 Units

Degree Applicable, CSU

Prerequisite: AGLI 16

Skills and procedures used in the management of an equine business.

41603	F	8:30am - 11:40am	Hoffman, A	80-1451
and	F	12:00pm - 3:10pm	Hoffman, A	80-1451

■ AGLI 19 — Horse Hoof Care 2.0 Units

Degree Applicable, CSU

41602	M	10:45am - 11:50am	Hoffman, A	80-1431
and	M	12:00pm - 3:10pm	Hoffman, A	80-1431

■ AGLI 30 — Beef Production 3.0 Units

Degree Applicable, CSU

44115	W	11:30am - 1:35pm	Phillips, J	80-1240
and	W	1:45pm - 4:55pm	Phillips, J	80-1240

■ AGLI 96 — Animal Sanitation and Disease Control 3.0 Units

Degree Applicable, CSU

41601	Th	3:30pm - 6:40pm	Loredo, J	80-1431
41604	T	5:15pm - 6:40pm	Lopez, A	80-1431
and	T	7:00pm - 8:25pm	Lopez, A	80-1431

AGRICULTURE: ORNAMENTAL HORTICULTURE

■ AGOR 1 — Horticultural Science 3.0 Units

Degree Applicable, CSU

Horticulture skills and techniques for use in gardening, nursery, and landscape applications. Off-campus meetings required.

41583	M	8:30am - 11:40am	Baugh, A	80-1331
41584	MW	1:45pm - 3:10pm	Hinostroza, J	80-1331
41585	TTh	1:45pm - 3:10pm	Hinostroza, J	80-1331
44176	M	5:30pm - 7:00pm	Perea, C	80-1401
		and arrange 1.6 hours	Perea, C	ONLINE
41586	Th	5:30pm - 7:00pm	Perea, C	80-1401
		and arrange 1.6 hours	Perea, C	ONLINE
41810		arrange 3.4 hours	STAFF	ONLINE

■ AGOR 2 — Plant Propagation/Greenhouse Management 3.0 Units

Degree Applicable, CSU

Plant propagation and production practices with emphasis on florists' plants, woody ornamentals, and fruits.

41587	M	5:30pm - 6:35pm	Ramirez, J	80-1200
and	M	6:45pm - 7:50pm	Ramirez, J	80-1200
and	M	8:00pm - 10:10pm	Ramirez, J	80-1200
		and arrange 1 hour	Ramirez, J	80-1200

■ AGOR 5 — Park Facilities 3.0 Units

Degree Applicable

Management and operation of different types of park facilities.

41811		arrange 3.4 hours	Perea, C	ONLINE
-------	--	-------------------	----------	--------

■ AGOR 13 — Landscape Design 3.0 Units

Degree Applicable, CSU, UC

Landscape design for residential and small commercial sites. Field trips and off-campus assignments required.

41590	T	5:30pm - 6:35pm	Scott, B	80-1421
and	T	6:45pm - 7:50pm	Scott, B	80-1421
and	T	8:00pm - 10:10pm	Scott, B	80-1421
		and arrange 1 hour	Scott, B	80-1421

■ AGOR 24 — Integrated Pest Management 3.0 Units

Degree Applicable, CSU

Agricultural pests in Southern California and use, safety, equipment, laws, and regulations of pesticides. Field trips required.

41592	W	5:30pm - 8:40pm	Perea, C	80-1421
		and arrange 2.25 hours	Perea, C	ONLINE

NOTE: CRN 41592 is a Distance Learning Online Class and has a required meeting on campus.

How to Begin Course: Log into Canvas through the e-Learning Tools tab in the Mt.SAC portal at inside.mtsac.edu. Then click on the Canvas link and then click on CRN for your DL course. **NOTE:** Some courses may not be activated until the start of the term. If you cannot locate your DL course in Canvas when the term starts, contact the professor. **On the first day of classes, log into your DL course to show your "attendance" because not doing so could result in your being dropped from the class for non-attendance.**

Professor contact info: Email Professor Perea at either: CPerea@mtsac.edu, through Student Detail Schedule or Canvas at MyMtSAC Portal.

Students must use their Mt.SAC e-mail account and be aware of course commitment and student expectations described at <http://www.mtsac.edu/distancelearning/>

To prepare for a successful online learning experience, see helpful short videos at <http://www.mtsac.edu/distancelearning/quiz/>

■ AGOR 29 — Ornamental Plants - Herbaceous 3.0 Units

Degree Applicable, CSU, UC

Off campus meetings required.

41597	W	5:30pm - 6:35pm	Hinostroza, J	80-1401
and	W	6:45pm - 7:50pm	Hinostroza, J	80-1401
and	W	8:00pm - 10:10pm	Hinostroza, J	80-1401
		and arrange 1 hour	Hinostroza, J	80-1401

■ AGOR 32 — Landscaping and Nursery Management 3.0 Units

Degree Applicable, CSU

Operation and management of wholesale and retail nurseries. Field trips required.

41591	T	5:30pm - 6:35pm	Baugh, A	80-1200
and	T	6:45pm - 7:50pm	Baugh, A	80-1200
and	T	8:00pm - 10:10pm	Baugh, A	80-1200
		and arrange 1 hour	Baugh, A	80-1200

■ AGOR 35 — Ornamental Plants for Southwest Climates 3.0 Units

Degree Applicable, CSU

Identification and ornamental use of California native and drought tolerant plants.

41637	S	9:00am - 11:05am	Perea, C	80-1421
and	S	11:30am - 2:40pm	Perea, C	80-1421

NOTE: CRN 41637 above requires student to attend required OFF CAMPUS Meetings.

■ AGOR 39 — Turf Grass Production and Management 3.0 Units

Degree Applicable, CSU

Cultivation, maintenance, and management of turfgrasses. Field trips required.

41594	M	5:30pm - 6:35pm	Scott, B	80-1421
and	M	6:45pm - 7:50pm	Scott, B	80-1421
and	M	8:00pm - 10:10pm	Scott, B	80-1421
		and arrange 1 hour	Scott, B	80-1421

■ AGOR 50 — Soil Science and Management 3.0 Units

Degree Applicable, CSU, UC

Principles of soil management, including management of air, water, nutrients, organic matter. Field trips required.

41589	Th	5:30pm - 6:35pm	Scott, B	80-1421
and	Th	6:45pm - 7:50pm	Scott, B	80-1421
and	Th	8:00pm - 10:10pm	Scott, B	80-1421
		and arrange 1 hour	Scott, B	80-1421

■ **AGOR 51 — Tractor and Landscape Equipment Operations** **3.0 Units**
Degree Applicable, CSU

Selection, operation, repair and maintenance of tractors and other power equipment used in the agriculture and landscape industry.

41588	S	9:00am - 11:05am	STAFF	80-1401
and S		11:30am - 2:40pm	STAFF	80-1401

■ **AGOR 53 — Small Engine Repair I** **3.0 Units**
Degree Applicable, CSU

Principles and repair of small engines used in landscape, industrial and agricultural applications.

44181	Th	5:30pm - 7:50pm	STAFF	80-1220
and Th		8:00pm - 10:10pm	STAFF	80-1220
		and arrange	1 hour STAFF	

■ **AGOR 62 — Irrigation Principles and Design** **3.0 Units**
Degree Applicable, CSU

Landscape irrigation principles, design, sprinkler systems, hydraulic principles, and water conservation. Field trips required.

41598	W	5:30pm - 6:35pm	Visosky, T	80-1220
and W		6:45pm - 7:50pm	Visosky, T	80-1220
and W		8:00pm - 10:10pm	Visosky, T	80-1220
		and arrange	1 hour Visosky, T	80-1220

■ **AGOR 63 — Irrigation Systems Management** **3.0 Units**
Degree Applicable, CSU

Systematic approach to water conservation in landscapes. Field trips are required.

41593	T	5:30pm - 6:35pm	Visosky, T	80-1220
and T		6:45pm - 7:50pm	Visosky, T	80-1220
and T		8:00pm - 10:10pm	Visosky, T	80-1220
		and arrange	1 hour Visosky, T	80-1220

■ **AGOR 72 — Landscape Hardscape Applications** **3.0 Units**
Degree Applicable, CSU

41596	W	5:30pm - 6:35pm	Merrick, L	80-1200
and W		6:45pm - 7:50pm	Merrick, L	80-1200
and W		8:00pm - 10:10pm	Merrick, L	80-1200
		and arrange	1 hour Merrick, L	80-1200

■ **AGOR 75 — Urban Arboriculture** **3.0 Units**
Degree Applicable

41595	T	5:30pm - 6:35pm	Hinostroza, J	80-1401
and T		6:45pm - 7:50pm	Hinostroza, J	80-1401
and T		8:00pm - 10:10pm	Hinostroza, J	80-1401
		and arrange	1 hour Hinostroza, J	80-1401

■ **AGOR 91 — Work Experience in Horticulture** **1.0 Unit**
Degree Applicable

(May be taken for Pass/No Pass Only)

Prerequisite: Three units of any AGOR course, with the exception of AGOR 1, must be taken prior to or concurrent with AGOR 91. Compliance with work experience regulations as designated in the College Catalog.

On-the-job experience at an approved work site. Minimum of 75 paid or 60 non-paid clock hours per credit unit.

41631	arrange	4.7 hours	Perea, C	80-2301H
-------	---------	-----------	----------	----------

■ **AGOR 91 — Work Experience in Horticulture** **2.0 Units**
Degree Applicable

(May be taken for Pass/No Pass Only)

Prerequisite: Three units of any AGOR course, with the exception of AGOR 1, must be taken prior to or concurrent with AGOR 91. Compliance with work experience regulations as designated in the College Catalog.

On-the-job experience at an approved work site. Minimum of 75 paid or 60 non-paid clock hours per credit unit.

41632	arrange	9.4 hours	Perea, C	80-2301H
-------	---------	-----------	----------	----------

■ **AGOR 91 — Work Experience in Horticulture** **3.0 Units**
Degree Applicable

(May be taken for Pass/No Pass Only)

Prerequisite: Three units of any AGOR course, with the exception of AGOR 1, must be taken prior to or concurrent with AGOR 91. Compliance with work experience regulations as designated in the College Catalog.

On-the-job experience at an approved work site. Minimum of 75 paid or 60 non-paid clock hours per credit unit.

41633	arrange	14.1 hours	Perea, C	80-2301H
-------	---------	------------	----------	----------

■ **AGOR 91 — Work Experience in Horticulture** **4.0 Units**
Degree Applicable

(May be taken for Pass/No Pass Only)

Prerequisite: Three units of any AGOR course, with the exception of AGOR 1, must be taken prior to or concurrent with AGOR 91. Compliance with work experience regulations as designated in the College Catalog.

On-the-job experience at an approved work site. Minimum of 75 paid or 60 non-paid clock hours per credit unit.

41634	arrange	18.8 hours	Perea, C	80-2301H
-------	---------	------------	----------	----------

AGRICULTURE: PET SCIENCE

■ **AGPE 71 — Canine Management** **3.0 Units**
Degree Applicable

41628	F	9:00am - 11:05am	Smith, J	80-1431
and F		11:30am - 2:40pm	Smith, J	80-1431

■ **AGPE 72 — Feline Management** **3.0 Units**
Degree Applicable

Advisory: Eligibility for ENGL 68

Care and management of cats.

41815	Th	12:00pm - 3:10pm	Pepper, S	80-1220
-------	----	------------------	-----------	---------

■ **AGPE 76 — Aviculture - Cage and Aviary Birds** **3.0 Units**
Degree Applicable

Cage and aviary birds marketed in the wholesale and retail pet trade.

44740	M	6:30pm - 9:40pm	Duncan, S	80-1431
-------	---	-----------------	-----------	---------

AIR CONDITIONING AND REFRIGERATION

■ **AIRC 10 — Technical Mathematics in Air Conditioning and Refrigeration** **2.0 Units**
Degree Applicable

Math for air conditioning and refrigeration including equations for air flow, electrical, heat loads and mechanical systems.

41440	T	7:00pm - 8:30pm	Kobzoff, F	69-6921
and T		8:40pm - 10:10pm	Kobzoff, F	69-6921

■ **AIRC 11 — Welding for Air Conditioning and Refrigeration** **2.0 Units**
Degree Applicable

Fundamentals of welding related to the field of air conditioning and refrigeration.

41563	F	9:00am - 9:50am	Soares, D	69-6924
and F		10:00am - 1:15pm	Soares, D	69-6924

■ **AIRC 12 — Air Conditioning Codes and Standards** **3.0 Units**
Degree Applicable

Skills necessary to read and interpret building codes and standards as they apply to air conditioning and refrigeration.

41431	W	7:00pm - 10:10pm	Lane, J	69-6921
-------	---	------------------	---------	---------

■ **AIRC 20 — Refrigeration Fundamentals** **4.0 Units**
Degree Applicable

Principles and application of mechanical refrigeration based on the refrigeration cycle and associated mechanical components.

41562	TTh	8:30am - 10:00am	Kobzoff, F	69-6924
and TTh		10:10am - 12:15pm	Kobzoff, F	69-6924
41432	TTh	6:45pm - 8:10pm	Soares, D	69-6924
and TTh		8:20pm - 10:25pm	Soares, D	69-6924



Air Conditioning & Refrigeration Technology

Get hands-on training with actual refrigeration components and systems — all using the latest technology.

Codes & Standards • Heat Loads
Pneumatics Gas Heating • Psychometrics
Refrigeration • Duct Design
Building Automation

For more information, please call:
909-274-5107

■ AIRC 25 — Electrical Fundamentals for Air Conditioning and Refrigeration 5.0 Units

Degree Applicable

Electrical principles as applied to air conditioning, refrigeration, and heat pump systems.

41497	MW	8:30am - 10:35am	Kobzoff, F	69-6922
and	MW	10:45am - 12:10pm	Kobzoff, F	69-6922
41433	MW	6:45pm - 8:50pm	Curtin, R	69-6922
and	MW	9:00pm - 10:20pm	Curtin, R	69-6922

■ AIRC 30 — Heat Load Calculations and Design 4.0 Units

Degree Applicable

Advisory: AIRC 20

Heat loss, heat gain, equipment selection, and duct sizing applied to residential dwelling air conditioning systems.

41435	W	1:30pm - 5:45pm	Richardson, L	69-6912
-------	---	-----------------	---------------	---------

■ AIRC 31 — Commercial Electrical for Air Conditioning and Refrigeration 4.0 Units

Degree Applicable

Advisory: AIRC 25

Electrical control of commercial air conditioning and refrigeration equipment as well as troubleshooting three-phase systems.

41436	TTh	1:15pm - 2:45pm	Richardson, L	69-6922
and	TTh	2:55pm - 4:25pm	Richardson, L	69-6922
44070	TTh	7:00pm - 8:30pm	Richardson, L	69-6922
and	TTh	8:40pm - 10:10pm	Richardson, L	69-6922

■ AIRC 34 — Advanced Mechanical Refrigeration 4.0 Units

Degree Applicable

Advisory: AIRC 20

Principles of mechanical air conditioning and refrigeration based on operating characteristics and pressure-enthalpy charts.

41438	MW	9:45am - 11:15am	Soares, D	69-6924
and	MW	11:25am - 12:55pm	Soares, D	69-6924

■ AIRC 61 — Building Automation Fundamentals 2.5 Units

Degree Applicable

Advisory: AIRC 20 and AIRC 25 and AIRC 31 and AIRC 34 and ELEC 11

Basics of commercial HVAC control theory for electric, pneumatic, and digital controls, process plants and air delivery methods.

41564	M	6:00pm - 8:10pm	Creed, R	69-6912
and	M	8:20pm - 10:10pm	Creed, R	69-6912

■ AIRC 95 — Work Experience in Air Conditioning and Refrigeration 2.0 Units

Degree Applicable

(May be taken for Pass/No Pass Only)

Prerequisite: Approval of college Work Experience supervisor and compliance with Work Experience regulations as designated in the College Catalog.

Work experience in Air Conditioning and Refrigeration. Instructor approval required.

41500		arrange	9.38 hours	Soares, D	69
-------	--	---------	------------	-----------	----

AIR TRAFFIC CONTROL

■ AIRT 151 — Aircraft Recognition and Performance 3.0 Units

Degree Applicable, CSU

Advisory: AERO 23 or AERO 100

Recognition of distinctive identification features of operational aircraft and their performance characteristics.

41426	T	6:30pm - 9:40pm	Shackelford, S	28B-103
-------	---	-----------------	----------------	---------

■ AIRT 201 — Terminal Air Traffic Control 3.0 Units

Degree Applicable, CSU

Advisory: AERO 23 or AERO 100 and AIRT 41 or AIRT 151

Aircraft control tower operations and terminal radar control.

41427	Th	12:00pm - 3:10pm	Shackelford, S	28B-103
-------	----	------------------	----------------	---------

■ AIRT 201L — Air Traffic Control Laboratory 1.0 Unit

Degree Applicable

Advisory: AERO 100

Concepts, procedures, and skills related to air traffic control.

41506	Th	7:00pm - 10:10pm	Hroblak, J	28B-103
-------	----	------------------	------------	---------

■ AIRT 203 — Enroute Air Traffic Control 3.0 Units

Degree Applicable, CSU

Advisory: AERO 23 or AERO 100 and AIRT 41 or AIRT 151

Enroute air traffic control including radar and non-radar separation.

41428	W	3:30pm - 6:40pm	Shackelford, S	28B-103
-------	---	-----------------	----------------	---------

■ AIRT 251 — Air Traffic Control Team Skills 1.5 Units

Degree Applicable, CSU

Advisory: AIRT 201 or AIRT 42A

Leadership skills for aviation professionals, with emphasis on air traffic control team skills.

41429	Th	3:30pm - 6:40pm	Shackelford, S	28B-103
8 Weeks, Week beginning 02/26/2018 ending 04/22/2018				

AIRCRAFT MAINTENANCE TECHNOLOGY

■ AIRM 65B — Aircraft Powerplant Maintenance Technology: Reciprocating and Turbine 13.0 Units

Degree Applicable, CSU

Prerequisite: AIRM 65A or (AIRM 95A and AIRM 95B and AIRM 96A and AIRM 96B)

Reciprocating and turbine engine systems and components. Required for FAA powerplant certification.

41477	TWTh	7:30am - 9:35am	Yost, D	28B-108
and	TWTh	9:45am - 12:00pm	Yost, D	28A-102
and	TWTh	12:35pm - 3:40pm	Yost, D	28A-102
and	F	7:30am - 11:35am	Wade, D	28A-102

■ AIRM 66B — Airframe Maintenance Technology 13.0 Units

Degree Applicable, CSU

Prerequisite: AIRM 66A OR (AIRM 90A and AIRM 90B and AIRM 91A and AIRM 91B)

Airframe systems and components. Required for FAA airframe certification.

41478	TWTh	7:30am - 9:35am	Strope, B	28B-104
and	TWTh	9:45am - 12:00pm	Strope, B	28A-102
and	TWTh	12:35pm - 3:40pm	Strope, B	28A-102
and	F	7:30am - 11:35am	Tram, V	28A-102

■ AIRM 70B — Aircraft Maintenance Electricity and Electronics 3.0 Units

Degree Applicable

Advisory: AIRM 70A and AIRM 71

Principles of alternating current electricity with emphasis on components and circuits. Required for FAA certification.

41479	M	7:00am - 9:15am	Tram, V	28B-403
and	M	9:25am - 11:30am	Tram, V	28A-102
and	M	12:30pm - 2:20pm	Tram, V	28A-102

■ AIRM 97A — Aircraft Powerplant Maintenance Technology: Instrumentation 3.0 Units

Degree Applicable

Prerequisite: (AIRM 95A and AIRM 95B and AIRM 96A and AIRM 96B) or AIRM 65B

FAA approved course covering instrumentation and smoke and fire detection and suppression systems.

44245	M	5:30pm - 10:35pm	STAFF	28B-108
and	T	5:30pm - 8:55pm	STAFF	28B-108
and	T	9:05pm - 10:40pm	STAFF	28A-102
and	WThF	5:30pm - 10:35pm	STAFF	28A-102

4 Weeks, Week beginning 02/26/2018 ending 03/25/2018

■ AIRM 97B — Aircraft Powerplant Maintenance Technology: Fuel Meter Systems 3.0 Units

Degree Applicable

Prerequisite: AIRM 97A or AIRM 65A

Reciprocating engine and turbine engine fuels and fuel metering systems. Required for FAA certification.

44246	M	5:30pm - 10:35pm	STAFF	28B-108
and	T	5:30pm - 8:55pm	STAFF	28B-108
and	T	9:05pm - 10:40pm	STAFF	28A-102
and	WThF	5:30pm - 10:35pm	STAFF	28A-102

4 Weeks, Week beginning 03/26/2018 ending 04/22/2018

■ AIRM 98A — Aircraft Powerplant Maintenance Technology: Ignition Systems 3.0 Units

Degree Applicable

Prerequisite: (AIRM 97A and AIRM 97B) or AIRM 65A

Reciprocating and turbine engine ignition system theory and maintenance. Required for FAA certification.

44249	M	5:30pm - 10:35pm	STAFF	28B-108
and	T	5:30pm - 8:55pm	STAFF	28B-108
and	T	9:05pm - 10:40pm	STAFF	28A-102
and	WThF	5:30pm - 10:35pm	STAFF	28A-102

4 Weeks, Week beginning 04/23/2018 ending 05/20/2018



Lift Off

(to an exciting career)

AIRCRAFT MAINTENANCE

- FAA-Certified Aircraft Maintenance Technician School
- Be Working in as soon as 2 years
- Day and evening classes
- Earn an A.S. degree or certificate

For information or shop tours, call
909-274-4762

■ AIRM 98B — Aircraft Powerplant Maintenance Technology: Lubricating Systems 3.0 Units

Degree Applicable

Prerequisite: (AIRM 97A and AIRM 97B and AIRM 98A) or AIRM 65A

Reciprocating and turbine engine lubricants and lubricating systems. Required for FAA certification.

44248	M	5:30pm - 10:35pm	STAFF	28B-108
and	T	5:30pm - 8:55pm	STAFF	28B-108
and	T	9:05pm - 10:40pm	STAFF	28A-102
and	WThF	5:30pm - 10:35pm	STAFF	28A-102

4 Weeks, Week beginning 05/21/2018 ending 06/17/2018

ALCOHOL DRUG COUNSELING

■ AD 1 — Alcohol/Drug Dependency 3.0 Units

Degree Applicable, CSU

Overview of alcohol/drug use and abuse. Effects on individuals, families and society. Various approaches to recovery.

41382	Th	11:30am - 2:40pm	Likens, J	67A-150
41383	Th	7:00pm - 10:10pm	Likens, J	67A-205

■ AD 2 — Physiological Effects of Alcohol/Drugs 3.0 Units

Degree Applicable, CSU

Examines the effects of alcohol/drugs on the human body. Includes tolerance, habituation, cross-tolerance and synergistic effect.

41387	W	3:00pm - 6:10pm	Smith, J	67A-216
41388	W	7:00pm - 10:10pm	Emadi, M	67A-215

■ AD 3 — Chemical Dependency: Intervention, Treatment and Recovery **3.0 Units**

Degree Applicable, CSU

Examines techniques used in chemical dependency treatment. Analyzes types of treatment programs and the essentials of recovery.

41389	T	3:00pm - 6:10pm	Staley, G	67A-216
41390	T	7:00pm - 10:10pm	Schafer, C	67A-216

■ AD 4 — Issues in Domestic Violence **3.0 Units**

Degree Applicable

History, law, and psychology of domestic violence. Cultural, social aspects, and relationship to substance abuse explored.

41392	Th	3:00pm - 6:10pm	Staley, G	67A-150
41391	M	7:00pm - 10:10pm	Staley, G	67A-225

■ AD 5 — Chemical Dependency: Prevention and Education **1.5 Units**

Degree Applicable, CSU

Examines success of prevention programs, influence of private and public attitudes, and basic steps for developing a program.

41393	M	5:15pm - 6:40pm	Staley, G	67A-225
-------	---	-----------------	-----------	---------

■ AD 6 — Dual Diagnosis **3.0 Units**

Degree Applicable, CSU

Overview of the complex interactions of mental disorders and chemical dependency. Examines disorders, treatment and aftercare.

41395	F	11:30am - 2:40pm	Smith, J	67A-206
41394	M	7:00pm - 10:10pm	Smith, J	67A-233

■ AD 8 — Group Process and Leadership **3.0 Units**

Degree Applicable

Advisory: AD 1, AD 2, AD 3 taken prior and AD 4, AD 5, AD 6 taken prior or concurrently

Introduces the theory and practice of group counseling, the group process and dynamics of group interaction.

41396	W	7:00pm - 10:10pm	Smith, J	67A-233
-------	---	------------------	----------	---------

■ AD 9 — Family Counseling **3.0 Units**

Degree Applicable

Advisory: (AD 1 and AD 2 and AD 3) taken prior AND (AD 4 and AD 5 and AD 6) taken prior or concurrently

Theory and practice of family counseling, family systems and dynamics, effects of chemical dependency, and counseling techniques.

41397	T	7:00pm - 10:10pm	Staley, G	67A-233
-------	---	------------------	-----------	---------

■ AD 10 — Client Record and Documentation **1.5 Units**

Degree Applicable

Advisory: AD 1, AD 2, AD 3 taken prior and AD 4, AD 5, AD 6 taken prior or concurrently

Documentation methods required by government regulatory bodies in clinical records. Emphasis on biopsychosocial history.

41384	W	6:30pm - 7:55pm	Staley, G	67A-205
-------	---	-----------------	-----------	---------

■ AD 11 — Techniques of Intervention and Referral **3.0 Units**

Degree Applicable

Advisory: AD 1, AD 2, AD 3 taken prior and AD 4, AD 5, AD 6 taken prior or concurrently

Explores crisis intervention, intake and referral methods. Practice active listening, responding, communicating on different levels.

41385	T	3:30pm - 6:40pm	Smith, J	67A-206
-------	---	-----------------	----------	---------

AMERICAN LANGUAGE

ENGLISH PLACEMENT

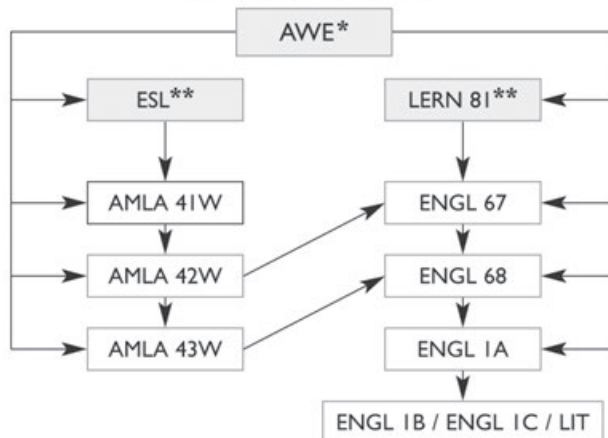

* Assessment of Written English Test — a test of your abilities in Language Usage. It is required for placement in English classes (including LERN, AMLA, and ESL classes), Business English classes, admission to the Health Science Program and all courses requiring English eligibility.

** Students may enroll in ESL (English as a Second Language) and LERN (for native speakers) without taking the AWE.

American Language Department courses are specifically designed to meet the needs of the students whose native (first) language is not English. The entering non-native speaker of English is placed into the appropriate writing level based on the AWE.

■ AMLA 21S — Accent Reduction **2.0 Units**
Not Degree Applicable

(May be taken for option of Letter grade or Pass/NoPass)

Pronunciation for non-native speakers with emphasis on accent reduction.

42304	MW	8:30am - 9:35am	Hill Enriquez, E	66-209
-------	----	-----------------	------------------	--------

■ AMLA 22S — American Language Interpersonal Communication **2.0 Units**
Not Degree Applicable

(May be taken for option of Letter grade or Pass/NoPass)

Enhances ability of non-native speakers to communicate with confidence and accuracy in personal and academic situations.

42305	MW	9:45am - 11:50am	Hill Enriquez, E	66-209
8 Weeks, Week beginning 02/26/2018 ending 04/22/2018				

■ AMLA 23S — American Language Formal Speaking **2.0 Units**
Not Degree Applicable

(May be taken for option of Letter grade or Pass/NoPass)

Advisory: Eligibility for AMLA 43W

Enhances the ability of non-native speakers to listen effectively and speak formally.

42306	MW	9:45am - 11:50am	Hill Enriquez, E	66-209
8 Weeks, Week beginning 04/23/2018 ending 06/17/2018				
43586	MW	12:00pm - 1:05pm	Hill Enriquez, E	66-209

■ AMLA 31R — American Language Basic Reading **4.0 Units**
Not Degree Applicable

(May be taken for option of Letter grade or Pass/NoPass)

Advisory: Eligibility for AMLA 41W

Basic reading and vocabulary for non-native speakers.

42287	MW	12:00pm - 2:05pm	Stokes, N	26A-2610
-------	----	------------------	-----------	----------

■ AMLA 32R — American Language Intermediate Reading 4.0 Units
Not Degree Applicable

(May be taken for option of Letter grade or Pass/NoPass)

Advisory: Eligibility for AMLA 42W

Intermediate reading and vocabulary for non-native speakers.

42288 MW 9:45am - 11:50am Casian, E 66-246

■ AMLA 33R — American Language Advanced Reading 4.0 Units
Degree Applicable

(May be taken for option of Letter grade or Pass/NoPass)

Advisory: Eligibility for AMLA 43W

Advanced reading and vocabulary for non-native speakers.

42289 TTh 7:30am - 9:35am Casian, E 66-246

42290 TTh 9:45am - 11:50am Casian, E 66-246

■ AMLA 41W — American Language Basic Writing 4.0 Units
Not Degree Applicable

(May be taken for option of Letter grade or Pass/NoPass)

*Prerequisite: Satisfactory score on the English Placement Test or successful completion of noncredit ESL Level 4**Advisory: AMLA 31R taken previously or concurrently*

Basic grammar and writing for non-native speakers.

42292 MTWTh 9:45am - 11:50am Stokes, N 26A-2610

8 Weeks, Week beginning 02/26/2018 ending 04/22/2018

42556 TTh 6:45pm - 8:50pm Habayeb, O 66-222

■ AMLA 42W — American Language Intermediate Writing 4.0 Units
Not Degree Applicable

(May be taken for option of Letter grade or Pass/NoPass)

*Prerequisite: Satisfactory score on the English Placement Test or successful completion of AMLA 41W or noncredit ESL Level 5 or 6 or VESL**Advisory: AMLA 32R taken prior or concurrently*

Intermediate grammar and writing for non-native speakers.

42293 MTWTh 7:30am - 9:35am Stokes, N 26A-2610

8 Weeks, Week beginning 02/26/2018 ending 04/22/2018

42294 MW 7:30am - 9:35am Casian, E 66-246

42295 MTWTh 9:45am - 11:50am Stokes, N 26A-2610

8 Weeks, Week beginning 04/23/2018 ending 06/17/2018

42296 MW 9:45am - 11:50am Mezaki, B 66-222

42494 TTh 12:00pm - 2:05pm Mezaki, B 66-222

42891 MW 6:45pm - 8:50pm Heinicke, D 66-246

42892 TTh 6:45pm - 8:50pm Goncalves, M 66-209

■ AMLA 43W — American Language Advanced Writing 4.0 Units
Not Degree Applicable

(May be taken for option of Letter grade or Pass/NoPass)

*Prerequisite: Satisfactory score on the English Placement Test or successful completion of AMLA 42W**Advisory: AMLA 33R taken prior or concurrently*

Advanced grammar and writing for non-native speakers.

42298 MTWTh 7:30am - 9:35am Stokes, N 26A-2610

8 Weeks, Week beginning 04/23/2018 ending 06/17/2018

42299 TTh 7:30am - 9:35am Malley, M 66-222

42300 MW 9:45am - 11:50am Bjorck, S 66-228

42301 TTh 9:45am - 11:50am Mezaki, B 66-222

42302 MW 12:00pm - 2:05pm Mezaki, B 66-222

42303 TTh 12:00pm - 2:05pm Stokes, N 26A-2610

42495 MW 2:15pm - 4:20pm Mezaki, B 66-222

42585 MW 6:45pm - 8:50pm Habayeb, O 66-222

42624 TTh 6:45pm - 8:50pm Heinicke, D 66-246

ANATOMY AND PHYSIOLOGY**■ ANAT 10A — Introductory Human Anatomy 4.0 Units**
Degree Applicable, CSU, UC*Advisory: BIOL 1*

Macroscopic and microscopic structure of the human body.

41642 M 8:00am - 11:10am Meyer, E 60-2503

and MW 11:30am - 12:55pm Meyer, E 11-2406

41644 T 8:00am - 11:10am Scott, S 60-2503

and TTh 11:30am - 12:55pm Scott, S 11-2406

41643 MW 11:30am - 12:55pm Meyer, E 11-2406

and W 8:00am - 11:10am Meyer, E 60-2503

41778 M 11:30am - 2:40pm STAFF 60-2503

and MW 3:00pm - 4:25pm STAFF 11-2406

41646 T 11:30am - 2:40pm STAFF 60-2503

and TTh 3:00pm - 4:25pm STAFF 11-2402

41645 TTh 11:30am - 12:55pm Scott, S 11-2406

and Th 8:00am - 11:10am Scott, S 60-2503

41796 MW 3:00pm - 4:25pm STAFF 11-2406

and W 11:30am - 2:40pm STAFF 60-2503

41647 TTh 3:00pm - 4:25pm Nguyen, K 11-2402

and Th 11:30am - 2:40pm STAFF 60-2503

41648 TTh 4:45pm - 6:10pm STAFF 11-2406

and T 7:00pm - 10:10pm STAFF 60-2503

41649 TTh 4:45pm - 6:10pm STAFF 11-2406

and Th 7:00pm - 10:10pm STAFF 60-2503

43691 TTh 7:00am - 7:50am Nguyen, K 60-2503

and T 8:00am - 11:10am Nguyen, K 11-2312

and Th 8:00am - 11:10am Nguyen, K 11-2312

and F 8:00am - 11:10am Nguyen, K 60-2503

and S 8:00am - 9:25am Nguyen, K 60-2503

8 Weeks, Week beginning 02/26/2018 ending 04/22/2018

43692 TTh 7:00am - 7:50am Nguyen, K 60-2503

and T 8:00am - 11:10am Nguyen, K 11-2312

and Th 8:00am - 11:10am Nguyen, K 11-2312

and F 8:00am - 11:10am Nguyen, K 60-2503

and S 8:00am - 9:25am Nguyen, K 60-2503

8 Weeks, Week beginning 04/23/2018 ending 06/17/2018**■ ANAT 10B — Introductory Human Physiology 4.0 Units**
Degree Applicable, CSU, UC*Prerequisite: ANAT 10A or ANAT 35**Advisory: (CHEM 10 or CHEM 40) and BIOL 1*

Integrated study of the functions of and interactions between human

organ systems.

41781 WF 8:00am - 9:25am Meyer, E 7-1120

and F 9:45am - 12:55pm STAFF 60-2515

41792 WF 8:00am - 9:25am Meyer, E 7-1120

and F 1:15pm - 4:25pm STAFF 60-2515

41650 TTh 9:45am - 11:10am STAFF 7-1120

and T 11:30am - 2:40pm STAFF 60-2515

41651 TTh 9:45am - 11:10am STAFF 11-2406

and Th 11:30am - 2:40pm STAFF 60-2515

41652 MW 5:15pm - 6:40pm STAFF 7-1120

and M 7:00pm - 10:10pm STAFF 60-2515

41653 MW 5:15pm - 6:40pm STAFF 7-1120

and W 7:00pm - 10:10pm STAFF 60-2515

■ ANAT 35 — Human Anatomy**5.0 Units**

Degree Applicable, CSU, UC

Prerequisite: BIOL 1 or BIOL 4 or BIOL 4H

Structure of organ systems at the gross, subgross, and microscopic levels based on human material and dissection of the cat.

41654	MW	8:00am - 11:10am	Rexach, C	60-2511
and	MW	1:15pm - 2:40pm	Rexach, C	11-2402
41656	TTh	8:00am - 11:10am	Poehner, W	60-2511
and	TTh	1:15pm - 2:40pm	Poehner, W	11-2402
41659	MW	9:45am - 11:10am	Pascoe, V	7-1104
and	MW	3:00pm - 6:10pm	Pascoe, V	60-2511
41818	MW	9:45am - 11:10am	Pascoe, V	7-1104
and	MW	11:30am - 6:24pm	Pascoe, V	60-2511
41657	TTh	9:45am - 11:10am	Presch, M	7-1104
and	TTh	11:30am - 2:40pm	Presch, M	60-2511
41658	TTh	9:45am - 11:10am	Presch, M	7-1104
and	TTh	3:00pm - 6:10pm	Presch, M	60-2511
41655	MW	1:15pm - 2:40pm	Rexach, C	11-2402
and	MW	3:00pm - 6:10pm	Rexach, C	60-2503
41661	MW	5:15pm - 6:40pm	Kennedy, W	11-2406
and	MW	7:00pm - 10:10pm	STAFF	60-2503
41662	MW	5:15pm - 6:40pm	Kennedy, W	11-2406
and	MW	7:00pm - 10:10pm	Kennedy, W	60-2511
41660	TTh	5:15pm - 6:40pm	Aasi, F	7-1104
and	TTh	7:00pm - 10:10pm	Aasi, F	60-2511

■ ANAT 36 — Human Physiology**5.0 Units**

Degree Applicable, CSU, UC

Prerequisite: BIOL 1 or BIOL 4 or BIOL 4H and ANAT 35 and CHEM 10 or CHEM 40

Human physiology at the cellular and molecular levels of all organ systems, including regulation and integration.

41663	MW	8:00am - 11:10am	Chamberlain, A	60-2515
and	MW	11:30am - 12:55pm	Chamberlain, A	7-1120
41665	TTh	8:00am - 11:10am	Pascoe, V	60-2515
and	TTh	1:15pm - 2:40pm	Rexach, C	11-2406
41664	MW	11:30am - 12:55pm	Chamberlain, A	7-1120
and	MW	3:00pm - 6:10pm	Chamberlain, A	60-2515
41667	MW	11:30am - 2:40pm	Presch, M	60-2515
and	MW	3:00pm - 4:25pm	Presch, M	7-1120
41666	TTh	1:15pm - 2:40pm	Rexach, C	11-2406
and	TTh	3:00pm - 6:10pm	STAFF	60-2515
41668	TTh	5:15pm - 6:40pm	STAFF	7-1120
and	TTh	7:00pm - 10:10pm	STAFF	60-2515

■ ANAT 40B — Human Prosection**2.0 Units**

Degree Applicable, CSU

Prerequisite: ANAT 40A

Techniques for human prosection. Organ systems, blood vessels, and nerves.

41669	TTh	3:00pm - 6:10pm	Chamberlain, A	60-2503A
-------	-----	-----------------	----------------	----------

■ ANAT 99 — Special Projects in Anatomy**2.0 Units**

Not Degree Applicable, CSU

41788		2.25 hours	STAFF	
41797	arrange	2.25 hours	STAFF	60-2503A

ANTHROPOLOGY**■ ANTH 1 — Biological Anthropology****3.0 Units**

Degree Applicable, CSU, UC

Prerequisite: Eligibility for ENGL 68

Evolutionary biology of primates, including and focusing on humans.

41670	MW	8:00am - 9:25am	Borella, F	61-2312
41677	TTh	8:00am - 9:25am	STAFF	60-2620
41672	MW	9:45am - 11:10am	STAFF	60-2620
41679	MW	9:45am - 11:10am	Borella, F	61-2312
41673	TTh	9:45am - 11:10am	Shereen, Y	60-2620
41675	TTh	11:30am - 12:55pm	STAFF	60-2620
41808	F	11:30am - 2:40pm	STAFF	60-2620
41674	MW	1:15pm - 2:40pm	Shereen, Y	60-2620
41678	TTh	1:15pm - 2:40pm	Meredith, S	60-2620
41671	M	7:00pm - 10:10pm	Wills, L	60-2620
41676	W	7:00pm - 10:10pm	Wills, L	60-2620

■ ANTH 1H — Biological Anthropology - Honors**3.0 Units**

Degree Applicable, CSU, UC

Prerequisite: Acceptance into the Honors Program

An honors course for accelerated students. See ANTH 1 for topics covered. May not receive credit for both ANTH 1 and ANTH 1H.

41680	TTh	8:00am - 9:25am	Borella, F	61-2312
-------	-----	-----------------	------------	---------

■ ANTH 1L — Biological Anthropology Laboratory**1.0 Unit**

Degree Applicable, CSU, UC

Corequisite: ANTH 1 or ANTH 1H (May have been taken previously)

Scientific study of human evolution. Hands-on experience with the subject matter of ANTH 1.

41682	F	8:00am - 11:10am	Borella, F	60-2620
41784	Th	3:00pm - 6:10pm	Barnes, A	60-2620
41681	Th	7:00pm - 10:10pm	Barnes, A	60-2620

■ ANTH 3 — Archaeology**3.0 Units**

Degree Applicable, CSU, UC

*Prerequisite: Eligibility for ENGL 1A**Advisory: READ 90*

Aims, methods and ethics of archaeological research and applications to the archaeological record. Text: 71 Degrees Reading Power.

41686	MW	11:30am - 12:55pm	STAFF	60-2620
-------	----	-------------------	-------	---------

■ ANTH 5 — Principles of Cultural Anthropology**3.0 Units**

Degree Applicable, CSU, UC

Social Science majors. Anthropological approach to study of human behavior; cross-cultural, comparative, evolutionary perspective.

41804	MW	11:30am - 12:55pm	Norvell, J	61-2312
41688	TTh	11:30am - 12:55pm	Norvell, J	61-2312

■ ANTH 22 — General Cultural Anthropology**3.0 Units**

Degree Applicable, CSU, UC

Introduction to nature of culture. May satisfy the cultural diversity requirement at transfer universities.

41684	MW	8:00am - 9:25am	Norvell, J	60-2620
43693	TTh	8:00am - 9:25am	Nightwine-Robinson, D	7-1209
41685	MW	1:15pm - 2:40pm	Norvell, J	61-2312
41785	TTh	1:15pm - 2:40pm	Norvell, J	61-2312
41683	T	7:00pm - 10:10pm	Nightwine-Robinson, D	61-2312

■ ANTH 30 — The Native American**3.0 Units**

Degree Applicable, CSU, UC

*Prerequisite: Eligibility for ENGL 1A**Advisory: Eligibility for READ 100*

Prehistory, history, and contemporary issues of Native Americans.

41687	TTh	9:45am - 11:10am	Borella, F	61-2312
-------	-----	------------------	------------	---------

ARABIC

■ ARAB 1 — Elementary Arabic **4.0 Units**
 Degree Applicable, CSU, UC

For students without previous exposure to Modern Arabic. Focuses on script, pronunciation, basic grammar and vocabulary.

44073	MW	12:00pm - 2:05pm	Aljord, H	21F-1
42910	TTh	12:00pm - 2:05pm	Hammad Hammad, M	21H-2
42911	MW	2:15pm - 4:20pm	Aljord, H	21F-1

■ ARAB 2 — Continuing Elementary Arabic **4.0 Units**
 Degree Applicable, CSU, UC

Prerequisite: ARAB 1 or equivalent

Further development of elementary vocabulary, reading, writing, and speaking skills in Arabic.

42912	TTh	9:45am - 11:50am	Hammad Hammad, M	21H-2
-------	-----	------------------	------------------	-------

ARCHITECTURAL TECHNOLOGY

■ ARCH 101 — Design I - Elements of Design **4.0 Units**
 Degree Applicable, CSU, UC

Corequisite: ARCH 121

Design and design process including conceptualization, site analysis, and related aspects. Portfolio produced. Field trips required.

41526	MW	8:00am - 9:25am	Sardinas, I	13-2220
	and MW	9:35am - 11:10am	Sardinas, I	13-2220

NOTE: ARCH 101 and ARCH 121 are co-requisites. You must enter a CRN for both courses on the registration screen at the same time.

41527	TTh	11:30am - 12:55pm	Sardinas, I	13-2220
	and TTh	1:05pm - 2:40pm	Sardinas, I	13-2220

NOTE: ARCH 101 and ARCH 121 are co-requisites. You must enter a CRN for both courses on the registration screen at the same time.

■ ARCH 102 — Design II - Architectural Design **4.0 Units**
 Degree Applicable, CSU, UC

Corequisite: ARCH 122 or ARCH 23

Advisory: ARCH 10 and ARCH 11 or ARCH 101 and ARCH 141

Second level architectural design. Field trips are required.

41533	MW	3:00pm - 4:25pm	Kuroki, H	13-2215
	and MW	4:35pm - 6:10pm	Kuroki, H	13-2215

NOTE: ARCH 102 and ARCH 122 are co-requisites. You must enter a CRN for both courses on the registration screen at the same time.

41570	MW	3:00pm - 4:25pm	DeJarnett, M	13-2220
	and MW	4:35pm - 6:10pm	DeJarnett, M	13-2220

NOTE: ARCH 102 and ARCH 122 are co-requisites. You must enter a CRN for both courses on the registration screen at the same time.

■ ARCH 121 — CADD and Digital Design Media Level I **4.0 Units**
 Degree Applicable, CSU, UC

Corequisite: ARCH 101

CADD Level 1 computer applications in architecture, engineering, and related fields. Field trips required.

41531	MW	8:00am - 9:25am	Lenox, J	13-2265
	and MW	9:35am - 11:10am	Lenox, J	13-2265
41530	TTh	8:00am - 9:25am	Chinchilla, M	13-2225
	and TTh	9:35am - 11:10am	Chinchilla, M	13-2225

NOTE: Current software used: AutoCAD 2017, Rhino3D, Adobe Photoshop, Microsoft Word, Excel, Powerpoint.

ARCH 121 and ARCH 101 are co-requisites. You must enter a CRN for both courses on the registration screen at the same time.

Design your future

We offer day and evening programs in:

- Architecture
- Inspection
- Illustration

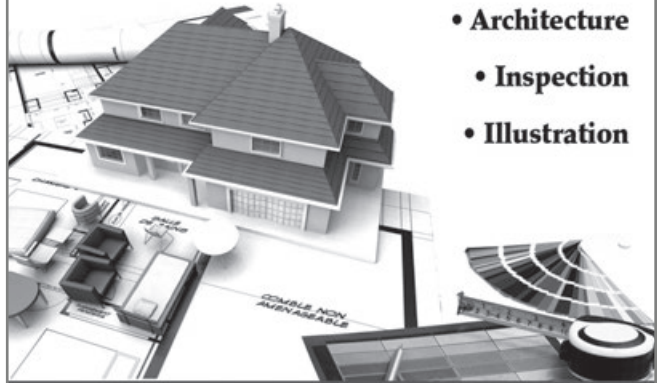

We have a great Club too – Architecture & Design Club Union (ADCU)

For more information, call **909-274-4803**

or check out the College website

www.mtsac.edu

■ ARCH 122 — Architectural Presentations **4.0 Units**
 Degree Applicable, CSU, UC

Corequisite: ARCH 21 or ARCH 102

Advisory: ARCH 10, ARCH 11 OR ARCH 101, ARCH 141

Architectural presentations including models and board layouts using hand-drawn and computer-aided techniques. Field trips required.

41534	MW	7:00pm - 8:25pm	Kuroki, H	13-2265
	and MW	8:35pm - 10:10pm	Kuroki, H	13-2220

NOTE: ARCH 122 and ARCH 102 are co-requisites. You must enter a CRN for both courses on the registration screen at the same time.

41571	MW	7:00pm - 8:25pm	Netsawang, P	13-2225
	and MW	8:35pm - 10:10pm	Netsawang, P	13-2215

NOTE: ARCH 122 and ARCH 102 are co-requisites. You must enter a CRN for both courses on the registration screen at the same time.

■ ARCH 141 — Design Drawing and Communication **4.0 Units**
 Degree Applicable, CSU, UC

Architectural drawing techniques. Field trips required.

41572	TTh	8:00am - 9:25am	DeJarnett, M	13-2215
	and TTh	9:35am - 11:10am	DeJarnett, M	13-2215

■ ARCH 142 — Architectural Materials and Specifications **4.0 Units**
 Degree Applicable, CSU

Advisory: Eligibility for MATH 51

Building materials and specifications used in architecture and construction. Field trips required.

41528	T	7:00pm - 10:10pm	Hernandez, A	28B-305
	and Th	7:00pm - 10:10pm	Hernandez, A	28B-305

■ ARCH 145 — Building and Zoning Codes **3.0 Units**
 Degree Applicable, CSU

Advisory: ARCH 141 or ARCH 11

Building and zoning code requirements for approval processes of architectural design, plan check, and building permits.

41529	M	7:00pm - 10:10pm	Fields, G	13-1245
-------	---	------------------	-----------	---------

■ ARCH 146 — Architectural Drawings and Fabrications **3.0 Units**
 Degree Applicable, CSU

Advisory: ARCH 141 (formerly ARCH 11)

Architectural working drawings and construction documents for light frame construction. Field trips required.

44321	TTh	3:00pm - 4:05pm	Kuroki, H	13-2225
	and TTh	4:15pm - 6:20pm	Kuroki, H	13-2220

■ **ARCH 202 — Design IV - Advanced Project** **4.0 Units**
Degree Applicable, CSU

Adv

Fourth level architectural design studio on sustainability, energy efficiency and environmental conservation. Field trips required.

41536	TTh	8:00am - 9:25am	Sardinas, I	13-2220
	and TTh	9:35am - 11:10am	Sardinas, I	13-2215

NOTE: You are highly advised to register for ARCH 222 concurrently.

■ **ARCH 222 — Advanced Digital Design, Illustration and Animation** **3.0 Units**
Degree Applicable, CSU

Advisory: ARCH 18 or ARCH 147

Architectural CAD 3-D illustration, rendering and animation, including walk-through and fly-through.

41535	TTh	7:00pm - 7:50pm	Griending, K	13-2225
	and TTh	8:00pm - 10:10pm	Griending, K	13-2225

■ **ARCH 250 — World Architecture I** **3.0 Units**
Degree Applicable, CSU, UC

Development of world architecture from pre-history to the Middle Ages. Field trips required.

41537	F	8:00am - 11:10am	Fields, G	13-2265
41573	F	8:00am - 11:10am	DeJarnett, M	13-2215

■ **ARCH 251 — World Architecture II** **3.0 Units**
Degree Applicable, CSU, UC

Development of world architecture from the Renaissance to the present. Field trips required.

41538	F	12:00pm - 3:10pm	Fields, G	13-2265
-------	---	------------------	-----------	---------

ART: ANIMATION

■ **ANIM 100 — Digital Paint and Ink** **3.0 Units**
Degree Applicable

Illustration skills used in digital animation and game production.

43848	TTh	8:00am - 8:50am	Rivas, H	13-2450
	and TTh	9:00am - 11:10am	Rivas, H	13-2450
43847	MW	11:30am - 12:20pm	Rivas, H	13-2450
	and MW	12:30pm - 2:40pm	Rivas, H	13-2450

NOTE: CRN 43847: No-cost digital textbooks or textual materials used.

43849	TTh	11:30am - 12:20pm	Rivas, H	13-2450
	and TTh	12:30pm - 2:40pm	Rivas, H	13-2450

NOTE: CRN 43849: No-cost digital textbooks or textual materials used.

43850	TTh	7:00pm - 7:50pm	Rivas, M	13-2450
	and TTh	8:00pm - 10:10pm	Rivas, M	13-2450

NOTE: CRN 43850: No-cost digital textbooks or textual materials used.

■ **ANIM 101A — Drawing - Gesture and Figure** **3.0 Units**
Degree Applicable, CSU

Contemporary and traditional approaches to sketching the human figure using drawing techniques for rapid visualization.

44026	F	9:45am - 11:50am	Dubiel, J	1A-4
	and F	12:00pm - 4:15pm	Dubiel, J	1A-4
44025	MW	11:30am - 12:20pm	Brown, R	1A-4
	and MW	12:30pm - 2:40pm	Brown, R	1A-4

■ **ANIM 101C — Figure Gesture Expressive Design** **3.0 Units**
Degree Applicable

Prerequisite: ANIM 101A

Sketching the human figure with emphasis on personal interpretation, expression, and media exploration.

44031	F	9:45am - 11:50am	Dubiel, J	1A-4
	and F	12:00pm - 4:15pm	Dubiel, J	1A-4
44028	MW	11:30am - 12:20pm	Brown, R	1A-4
	and MW	12:30pm - 2:40pm	Brown, R	1A-4

■ **ANIM 104 — Drawing Fundamentals** **3.0 Units**
Degree Applicable, CSU

Creative expression through the use of drawing media and techniques. May require off-campus assignments.

44034	MW	3:30pm - 4:20pm	Husband, R	1B/C-4
	and MW	4:30pm - 6:40pm	Husband, R	1B/C-4
44033	MW	7:00pm - 7:50pm	Donahue, J	1A-4
	and MW	8:00pm - 10:10pm	Donahue, J	1A-4

■ **ANIM 108 — Principles of Animation** **3.0 Units**
Degree Applicable, CSU

Principles of drawing for traditional animation concentrating on the mechanics of movement, timing, and emotion.

43852	MW	7:00pm - 7:50pm	Pai, A	13-2450
	and MW	8:00pm - 10:10pm	Pai, A	13-2450

NOTE: CRN 43852: No-cost digital textbooks or textual materials used.

43853	S	9:30am - 11:35am	Solorzano, E	13-2450
	and S	11:45am - 3:55pm	Solorzano, E	13-2450

NOTE: CRN 43853: No-cost digital textbooks or textual materials used.

■ **ANIM 115 — Storyboarding** **3.0 Units**
Degree Applicable, CSU

Prerequisite: ANIM 100

Storyboarding with emphasis on storytelling, cinematography, drawing, and notation as it relates to the animation industry.

43846	MW	8:00am - 8:50am	Rivas, H	13-2450
	and MW	9:00am - 11:10am	Rivas, H	13-2450

NOTE: CRN 43846: No-cost digital textbooks or textual materials used.

■ **ANIM 116 — Character Development** **1.5 Units**
Degree Applicable

Prerequisite: ARTD 15A or ANIM 104

Drawing and development of characters for animation.

44051	F	1:30pm - 2:35pm	Reed, J	1B/C-3
	and F	2:45pm - 4:50pm	Reed, J	1B/C-3

Put your career in motion!

Animation

Degree and Certificate Options

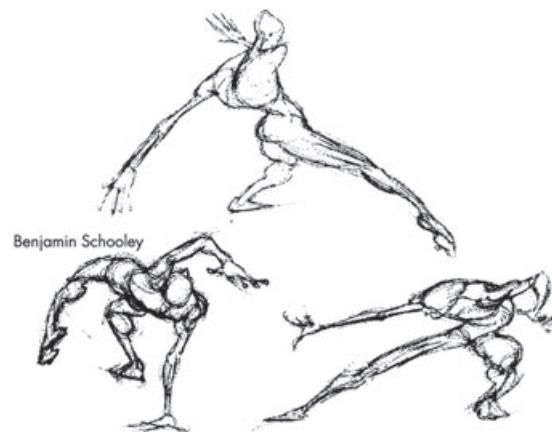

for more information, contact Debbie Bautista
909-274-4565

■ **ANIM 130 — Introduction to 3D Modeling** **3.0 Units**
Degree Applicable, CSU, UC

3D modeling techniques using animation and gaming industry-standard software.

43917 MW 8:00am - 8:50am Thankamushy, S 13-2435
and MW 9:00am - 11:10am Thankamushy, S 13-2435

NOTE: CRN 43917: No-cost digital textbooks or textual materials used.

43918 MW 11:30am - 12:20pm Thankamushy, S 13-2435
and MW 12:30pm - 2:40pm Thankamushy, S 13-2435

NOTE: CRN 43918: No-cost digital textbooks or textual materials used.

■ **ANIM 131 — Introduction to Gaming** **3.0 Units**
Degree Applicable, CSU, UC

(May be taken for option of Letter grade or Pass/NoPass)

The field of game design including the principles, tools, and strategies for designing various types of games.

43920 TTh 8:00am - 8:50am Thankamushy, S 13-2435
and TTh 9:00am - 11:10am Thankamushy, S 13-2435

NOTE: CRN 43920: No-cost digital textbooks or textual materials used.

43921 MW 3:00pm - 3:50pm Thornton, J 13-2435
and MW 4:00pm - 6:10pm Thornton, J 13-2435

NOTE: CRN 43921: No-cost digital textbooks or textual materials used.

43922 MW 7:00pm - 7:50pm Vales, J 13-2435
and MW 8:00pm - 10:10pm Vales, J 13-2435

NOTE: CRN 43922: No-cost digital textbooks or textual materials used.

■ **ANIM 132 — Intermediate 3D Modeling** **3.0 Units**
Degree Applicable, CSU

Prerequisite: ANIM 130 and ANIM 100

Advisory: ANIM 104

3D modeling and texturing methods used in the film and game industries using Maya software.

43923 TTh 3:00pm - 3:50pm Gend, P 13-2435
and TTh 4:00pm - 6:10pm Gend, P 13-2435

■ **ANIM 141 — 2D Game Level Design** **3.0 Units**
Degree Applicable, CSU

Prerequisite: ANIM 131

Design of game levels based upon storytelling, platform and theme.

43924 TTh 11:30am - 12:20pm Thankamushy, S 13-2435
and TTh 12:30pm - 2:40pm Thankamushy, S 13-2435

NOTE: CRN 43924: No-cost digital textbooks or textual materials used.

■ **ANIM 148 — Demo Reel** **3.0 Units**
Degree Applicable

Prerequisite: Completion of a minimum of 9 semester units in one of the following programs: Graphic Design, Illustration, Animation, Web Design, Architectural Design, Art, Fashion Merchandising, Industrial Design, Interior Design, or Photography.

Production of a demo reel and portfolio representative of skills for entry into the animation field.

43925 TTh 7:00pm - 7:50pm Piedra, D 13-2435
and TTh 8:00pm - 10:10pm Piedra, D 13-2435

NOTE: CRN 43925: No-cost digital textbooks or textual materials used.

■ **ANIM 167 — Visual Development** **3.0 Units**
Degree Applicable, CSU

Prerequisite: ARTC 163 or (ANIM 101A AND ARTD 16)

Development of conceptual designs using value, design, color, and composition. Cannot receive credit for ARTC 167 and ANIM 167.

44296 TTh 8:00am - 8:50am Tedja Kusuma, F 13-2460
and TTh 9:00am - 11:10am Tedja Kusuma, F 13-2460

■ **ANIM 172 — Motion Graphics, Compositing and Visual Effects** **3.0 Units**
Degree Applicable, CSU

Prerequisite: ARTC 100 or ANIM 100

Elements of motion graphics and visual effects. ANIM 172 and ARTC 272 cannot both be taken for credit.

44212 MW 11:30am - 12:20pm Chu, G 13-2445
and MW 12:30pm - 2:40pm Chu, G 13-2445

■ **ANIM 175 — Digital Animation** **3.0 Units**
Degree Applicable

Prerequisite: ANIM 100 or ARTC 100

Principles of animation using digital software for multimedia.

43851 MW 3:00pm - 3:50pm Dunipace, T 13-2450
and MW 4:00pm - 6:10pm Dunipace, T 13-2450

NOTE: CRN 43851: No-cost digital textbooks or textual materials used.

ART: BASIC STUDIO ARTS

■ **ARTB 1 — Understanding the Visual Arts** **3.0 Units**
Degree Applicable, CSU, UC

Prerequisite: Eligibility for ENGL 68

Visual art forms and role of art in history, culture; off-campus trips possible. Credit not given for both ARTB 1 and AHIS 1.

43926 TTh 11:30am - 12:55pm Macias, M 1B/C-12
43928 Th 1:15pm - 4:25pm Macias, M 1B/C-12

■ **ARTB 14 — Basic Studio Arts** **3.0 Units**
Degree Applicable, CSU, UC

Prerequisite: Eligibility for ENGL 68

Creative expression through the visual and applied arts. May require field trips.

43700 MW 8:00am - 8:50am Jacobs, G 1A-1A1
and MW 9:00am - 11:10am Jacobs, G 1A-1A1
43699 TTh 8:00am - 8:50am Macias, M 1A-1A1
and TTh 9:00am - 11:10am Macias, M 1A-1A1
43702 F 9:00am - 11:05am Park, B 1A-3
and F 11:15am - 3:30pm Park, B 1A-3
43697 MW 11:30am - 12:20pm Macias, M 1A-1A1
and MW 12:30pm - 2:40pm Macias, M 1A-1A1
43701 TTh 7:00pm - 7:50pm Florio, M 1A-1A1
and TTh 8:00pm - 10:10pm Florio, M 1A-1A1

ART: GALLERY AND PROFESSIONAL PRACTICES

■ **ARTG 20 — Art, Artists and Society** **3.0 Units**
Degree Applicable, CSU

Art and artists studied through lectures and required field trips. Public art display, exhibition, art movements and styles.

43929 TTh 3:00pm - 3:50pm Burnes, F 1B/C-3
and TTh 4:00pm - 6:10pm Betz, M 1B/C-3

ART: GRAPHIC DESIGN AND ILLUSTRATION

■ **ARTC 100 — Graphic Design I** **3.0 Units**
Degree Applicable, CSU

Advisory: ARTD 15A and ARTD 20

Contemporary graphic design for the commercial art industry. Software: Adobe Photoshop, Adobe Illustrator.

43732 MW 8:00am - 8:50am Bouskill, B 13-2440
and MW 9:00am - 11:10am Bouskill, B 13-2440
43735 TTh 8:00am - 8:50am Burgoon, S 13-2440
and TTh 9:00am - 11:10am Burgoon, S 13-2440
43736 MW 11:30am - 12:20pm Bouskill, B 13-2440
and MW 12:30pm - 2:40pm Bouskill, B 13-2440
43743 TTh 11:30am - 12:20pm Burgoon, S 13-2440
and TTh 12:30pm - 2:40pm Burgoon, S 13-2440
43746 TTh 3:00pm - 3:50pm Bouskill, B 13-2440
and TTh 4:00pm - 6:10pm Bouskill, B 13-2440
43749 MW 6:30pm - 7:20pm Dennis, A 13-2440
and MW 7:30pm - 9:40pm Dennis, A 13-2440

■ ARTC 120 — Graphic Design II **3.0 Units**

Degree Applicable, CSU

Prerequisite: ARTC 100*Corequisite:* ARTD 20 (May be taken previously)

Graphic design concepts for the design and layout of printed commercial art. Software: Adobe InDesign.

43753	MW	8:00am - 8:50am	Hartmann, C	13-2445
and	MW	9:00am - 11:10am	Hartmann, C	13-2445
43755	TTh	6:30pm - 7:20pm	Garcia, E	13-2440
and	TTh	7:30pm - 9:40pm	Garcia, E	13-2440

■ ARTC 140 — Graphic Design III **3.0 Units**

Degree Applicable

Prerequisite: ARTC 100 and ARTD 20

Digital illustration, design, skills and concepts working with vector art. Software: Adobe Illustrator.

43758	MW	6:30pm - 7:20pm	Burgoon, S	13-2445
and	MW	7:30pm - 9:40pm	Burgoon, S	13-2445

■ ARTC 160 — Typography **3.0 Units**

Degree Applicable, CSU

Prerequisite: ARTC 100*Corequisite:* ARTD 20 (may have been taken previously)

Design and use of basic letterforms, type families, characteristics, history, and principles of typography in graphic design.

43773	F	10:00am - 12:05pm	Minassian, P	13-2460
and	F	12:15pm - 4:30pm	Minassian, P	13-2460

■ ARTC 163 — Dynamic Sketching **3.0 Units**

Degree Applicable, CSU

Prerequisite: ARTD 15A or ANIM 104

Essential tools to conceptualize, communicate, and express creative ideas dynamically through the art of sketching.

43777	F	10:00am - 12:05pm	Nguyen, H	13-2445
and	F	12:15pm - 4:30pm	Nguyen, H	13-2445

■ ARTC 165 — Illustration **3.0 Units**

Degree Applicable, CSU

Prerequisite: ARTD 15A or ANIM 104*Corequisite:* ARTD 20 or ARTD 21 or ARTD 17A or ANIM 101A (any of which may have been taken previously)

Contemporary illustration using a variety of techniques, media, and approaches in painting and drawing.

43781	MW	8:00am - 8:50am	Batcheller, K	1B/C-3
and	MW	9:00am - 11:10am	Batcheller, K	1B/C-3

■ ARTC 167 — Visual Development **3.0 Units**

Degree Applicable, CSU

Prerequisite: ARTC 163 or (ANIM 101A AND ARTD 16)

Development of conceptual designs using value, design, color, and composition. Cannot receive credit for ARTC 167 and ANIM 167.

43786	TTh	8:00am - 8:50am	Tedja Kusuma, F	13-2460
and	TTh	9:00am - 11:10am	Tedja Kusuma, F	13-2460

■ ARTC 200 — Web Design **3.0 Units**

Degree Applicable, CSU

Prerequisite: ARTC 100 and ARTD 20

Design, usability, production and marketing of web sites.

43789	MW	11:30am - 12:20pm	Howland, T	13-2460
and	MW	12:30pm - 2:40pm	Howland, T	13-2460

■ ARTC 210 — Corporate Identity and Branding **3.0 Units**

Not Degree Applicable

Prerequisite: ARTC 140 and ARTC 160

Creative techniques, design theory, and process methods for developing effective logos, corporate identity systems, and brands.

43793	TTh	11:30am - 12:20pm	Jackson, B	13-2445
and	TTh	12:30pm - 2:40pm	Jackson, B	13-2445

■ ARTC 272 — Motion Graphics, Compositing and Visual Effects **3.0 Units**

Degree Applicable, CSU

Prerequisite: ARTC 100 or ANIM 100

Elements of motion graphics and visual effects. ANIM 172 and ARTC 272 cannot both be taken for credit.

43798	MW	11:30am - 12:20pm	Chu, G	13-2445
and	MW	12:30pm - 2:40pm	Chu, G	13-2445

■ ARTC 290 — Portfolio **3.0 Units**

Degree Applicable

Prerequisite: Completion of a minimum of 15 semester units in one of the following programs: Graphic Design, Illustration, Animation and Gaming, Architectural Design, Art, Fashion Merchandising, Industrial Design, Interior Design, or Photography.

Selection and assembly of a visual arts portfolio, including digital and multimedia formats, for entering profession or transfer.

43806	MW	3:00pm - 3:50pm	Howland, T	13-2460
and	MW	4:00pm - 6:10pm	Howland, T	13-2460

ART: THREE-DIMENSIONAL STUDIO ARTS**■ ARTS 22 — Design: Three-Dimensional** **3.0 Units**

(C-ID ARTS 101) Degree Applicable, CSU, UC

Prerequisite: Eligibility for ENGL 68

Develops perception and enhances design decision making within the three-dimensional world using a variety of materials.

43931	TTh	9:45am - 10:35am	Deines, C	1A-7
and	TTh	10:45am - 12:55pm	Deines, C	1A-7
43930	MW	11:30am - 12:20pm	Alexander, C	1A-7
and	MW	12:30pm - 2:40pm	Alexander, C	1A-7
43933	MW	7:00pm - 7:50pm	Deines, C	1A-7
and	MW	8:00pm - 10:10pm	Deines, C	1A-7

■ ARTS 30A — Ceramics: Beginning I **3.0 Units**

Degree Applicable, CSU, UC

Clay, glazes and firing through projects and analysis, using hand building and the wheel. Field trip required.

43971	MW	8:00am - 8:50am	Hopkins, H	1A-10
and	MW	9:00am - 11:10am	Hopkins, H	1A-10
43989	F	9:00am - 11:05am	Lewis, N	1A-10
and	F	11:15am - 3:30pm	Lewis, N	1A-10
43976	MW	11:30am - 12:20pm	Rubenstein, S	1A-10
and	MW	12:30pm - 2:40pm	Rubenstein, S	1A-10
44023	TTh	1:15pm - 2:05pm	Rubenstein, S	1A-10
and	TTh	2:15pm - 4:25pm	Rubenstein, S	1A-10
43973	MW	3:00pm - 3:50pm	Rubenstein, S	1A-10
and	MW	4:00pm - 6:10pm	Rubenstein, S	1A-10
43980	MW	7:00pm - 7:50pm	Keena, S	1A-10
and	MW	8:00pm - 10:10pm	Keena, S	1A-10
43986	TTh	7:00pm - 7:50pm	Reynoso, H	1A-10
and	TTh	8:00pm - 10:10pm	Reynoso, H	1A-10
43993	S	9:00am - 11:05am	Queen, K	1A-10
and	S	11:15am - 3:30pm	Queen, K	1A-10

■ ARTS 30B — Ceramics: Beginning II **3.0 Units**

Degree Applicable, CSU, UC

(May be taken for option of Letter grade or Pass/NoPass)

Prerequisite: ARTS 30A

Clay, glazes and firing with emphasis on development of technique and concept. Field trip required.

44010	F	9:00am - 11:05am	Lewis, N	1A-10
and	F	11:15am - 3:30pm	Lewis, N	1A-10
43998	MW	11:30am - 12:20pm	Rubenstein, S	1A-10
and	MW	12:30pm - 2:40pm	Rubenstein, S	1A-10
44018	TTh	1:15pm - 2:05pm	Rubenstein, S	1A-10
and	TTh	2:15pm - 4:25pm	Rubenstein, S	1A-10
44003	MW	7:00pm - 7:50pm	Keena, S	1A-10
and	MW	8:00pm - 10:10pm	Keena, S	1A-10
44006	TTh	7:00pm - 7:50pm	Reynoso, H	1A-10
and	TTh	8:00pm - 10:10pm	Reynoso, H	1A-10
44015	S	9:00am - 11:05am	Queen, K	1A-10
and	S	11:15am - 3:30pm	Queen, K	1A-10

■ ARTS 31 — Ceramics: Advanced Studio **2.0 Units**

Degree Applicable

(May be taken for option of Letter grade or Pass/NoPass)

Prerequisite: ARTS 30B

Advanced ceramics; emphasis on integrating form, surface, and content. Loading and firing kilns included. Field trips required.

44036	F	9:00am - 3:30pm	Lewis, N	1A-10
44029	MW	3:00pm - 6:10pm	Rubenstein, S	1A-10
44038	S	9:00am - 3:30pm	Queen, K	1A-10

■ ARTS 33 — Ceramics: Hand Construction **3.0 Units**

Degree Applicable, CSU, UC

Clay handbuilding techniques, glazes and firing through projects and their analysis. Field trip required.

44042	TTh	9:45am - 10:35am	Jilek, C	1A-10
	and TTh	10:45am - 12:55pm	Jilek, C	1A-10

■ ARTS 34 — The Sculptural Vessel **3.0 Units**

Degree Applicable, CSU, UC

(May be taken for option of Letter grade or Pass/NoPass)

*Prerequisite: ARTS 30A**Advisory: ARTS 33*

Advanced study of the ceramic vessel through the integration of technique, form, and content. Field trips required.

43698	TTh	9:45am - 10:35am	Jilek, C	1A-10
	and TTh	10:45am - 1:55pm	Jilek, C	1A-10

■ ARTS 40A — Sculpture: Beginning **3.0 Units**

Degree Applicable, CSU, UC

Traditional and contemporary approaches to sculpture.

44043	MW	8:00am - 8:50am	Thomas, N	1A-7
	and MW	9:00am - 11:10am	Thomas, N	1A-7
44044	MW	3:00pm - 3:50pm	Persinger, R	1A-7
	and MW	4:00pm - 6:10pm	Persinger, R	1A-7

■ ARTS 40B — Sculpture: Intermediate **3.0 Units**

Degree Applicable, CSU, UC

(May be taken for option of Letter grade or Pass/NoPass)

Prerequisite: ARTS 40A

Sculpture projects in subtractive, additive and manipulative approaches.

44045	MW	8:00am - 8:50am	Thomas, N	1A-7
	and MW	9:00am - 11:10am	Thomas, N	1A-7
44046	MW	3:00pm - 3:50pm	Persinger, R	1A-7
	and MW	4:00pm - 6:10pm	Persinger, R	1A-7

■ ARTS 41A — Sculpture: Life **3.0 Units**

Degree Applicable, CSU, UC

Modeling from the human figure with emphasis on composition, gesture, motion and human anatomy as it informs sculptural form.

44047	TTh	1:15pm - 2:05pm	Alexander, C	1A-7
	and TTh	2:15pm - 4:25pm	Alexander, C	1A-7

■ ARTS 41B — Sculpture: Intermediate Life **3.0 Units**

Degree Applicable, CSU, UC

Prerequisite: ARTS 41A

Sculptural study of the human figure with emphasis on artistic development and stylistic exploration of human anatomy.

44048	TTh	1:15pm - 2:05pm	Alexander, C	1A-7
	and TTh	2:15pm - 4:25pm	Alexander, C	1A-7

■ ARTS 46A — Sculpture: Special Effects Makeup **3.0 Units**

Degree Applicable

(May be taken for option of Letter grade or Pass/NoPass)

Advisory: ARTS 42

Modeling, molding, casting of make-up appliances and masks to the human figure.

44049	TTh	7:00pm - 7:50pm	Smith, G	1A-7
	and TTh	8:00pm - 10:10pm	Smith, G	1A-7

■ ARTS 46B — Sculpture: Special Effects Makeup **3.0 Units**

Degree Applicable

(May be taken for option of Letter grade or Pass/NoPass)

Prerequisite: ARTS 46A

Sculpture special effects modeling, molding and casting techniques.

44050	TTh	7:00pm - 7:50pm	Smith, G	1A-7
	and TTh	8:00pm - 10:10pm	Smith, G	1A-7

ART: TWO-DIMENSIONAL STUDIO ARTS**■ ARTD 15A — Drawing: Beginning** **3.0 Units**

(C-ID ARTS 110)

Degree Applicable, CSU, UC

An entry level course emphasizing creative expression through the use of drawing media.

43703	MW	8:00am - 8:50am	Butler, T	1B/C-5
	and MW	9:00am - 11:10am	Butler, T	1B/C-5
43704	MW	8:00am - 8:50am	Macias, M	1B/C-4
	and MW	9:00am - 11:10am	Macias, M	1B/C-4
43705	TTh	8:00am - 8:50am	Butler, T	1B/C-4
	and TTh	9:00am - 11:10am	Butler, T	1B/C-4
43706	TTh	8:00am - 8:50am	Brown, D	1B/C-5
	and TTh	9:00am - 11:10am	Brown, D	1B/C-5
43707	F	9:00am - 11:05am	Butler, D	1B/C-5
	and F	11:15am - 3:20pm	Butler, D	1B/C-5
43708	F	9:00am - 11:05am	Synicky, C	1B/C-4
	and F	11:15am - 3:20pm	Synicky, C	1B/C-4
43709	TTh	9:45am - 10:35am	Alexander, C	1A-4
	and TTh	10:45am - 12:55pm	Alexander, C	1A-4
43711	MW	11:30am - 12:20pm	Hagner, D	1B/C-4
	and MW	12:30pm - 2:40pm	Hagner, D	1B/C-4
43712	TTh	11:30am - 12:20pm	Burnes, F	1B/C-4
	and TTh	12:30pm - 2:40pm	Burnes, F	1B/C-4
43713	TTh	11:30am - 12:20pm	Butler, T	1B/C-5
	and TTh	12:30pm - 2:40pm	Butler, T	1B/C-5
43714	TTh	1:15pm - 2:05pm	Foster, E	1A-4
	and TTh	2:15pm - 4:25pm	Foster, E	1A-4
43716	TTh	3:00pm - 3:50pm	Potter, S	1B/C-5
	and TTh	4:00pm - 6:10pm	Potter, S	1B/C-5
43715	MW	3:30pm - 4:20pm	Impert, W	1B/C-5
	and MW	4:30pm - 6:40pm	Impert, W	1B/C-5
43717	MW	7:00pm - 7:50pm	Meredith, S	1B/C-5
	and MW	8:00pm - 10:10pm	Meredith, S	1B/C-5
43718	TTh	7:00pm - 7:50pm	Frost, K	1B/C-4
	and TTh	8:00pm - 10:10pm	Frost, K	1B/C-4
43710	S	9:45am - 11:50am	Schlichtenmyer, S	1B/C-5
	and S	12:00pm - 4:15pm	Schlichtenmyer, S	1B/C-5
43719	S	9:45am - 11:50am	Foster, E	1B/C-4
	and S	12:00pm - 4:15pm	Foster, E	1B/C-4

■ ARTD 16 — Drawing: Perspective **3.0 Units**

Degree Applicable, CSU, UC

Prerequisite: ARTD 15A or ANIM 104

Linear perspective drawing techniques for artists and illustrators.

43977	TTh	8:00am - 8:50am	Bautista, S	13-2445
	and TTh	9:00am - 11:10am	Bautista, S	13-2445

■ ARTD 17A — Drawing: Life **3.0 Units**

(C-ID ARTS 200)

Degree Applicable, CSU, UC

Prerequisite: ARTD 15A or ANIM 104

Contemporary and traditional approaches to drawing the human figure.

43948	MW	8:00am - 8:50am	Brown, R	1A-4
	and MW	9:00am - 11:10am	Brown, R	1A-4
43950	MW	3:00pm - 3:50pm	Stubbs, T	1A-4
	and MW	4:00pm - 6:10pm	Stubbs, T	1A-4
43954	TTh	7:00pm - 7:50pm	Weatherly, M	1A-4
	and TTh	8:00pm - 10:10pm	Weatherly, M	1A-4

■ ARTD 17B — Drawing: Life-Advanced **3.0 Units**

Degree Applicable, CSU, UC

Prerequisite: ARTD 17A

Contemporary and traditional approaches to sketching/drawing the human figure.

43961	MW	8:00am - 8:50am	Brown, R	1A-4
and MW		9:00am - 11:10am	Brown, R	1A-4
43962	MW	3:00pm - 3:50pm	Stubbs, T	1A-4
and MW		4:00pm - 6:10pm	Stubbs, T	1A-4
43963	TTh	7:00pm - 7:50pm	Weatherly, M	1A-4
and TTh		8:00pm - 10:10pm	Weatherly, M	1A-4

■ ARTD 20 — Design: Two-Dimensional **3.0 Units**

(C-ID ARTS 100) Degree Applicable, CSU, UC

Prerequisite: Eligibility for ENGL 68

Two-dimensional composition in achromatic value and color using principles of art and design. May require off-campus assignments.

43982	MW	8:00am - 8:50am	Smith, C	1A-3
and MW		9:00am - 11:10am	Smith, C	1A-3
43983	TTh	8:00am - 8:50am	Kahn, J	1B/C-3
and TTh		9:00am - 11:10am	Kahn, J	1B/C-3
43979	MW	11:30am - 12:20pm	Rohlander, N	1A-3
and MW		12:30pm - 2:40pm	Rohlander, N	1A-3
43981	MW	3:00pm - 3:50pm	Wasson, S	1A-3
and MW		4:00pm - 6:10pm	Wasson, S	1A-3
43984	MW	7:00pm - 7:50pm	Wasson, S	1A-3
and MW		8:00pm - 10:10pm	Wasson, S	1A-3

■ ARTD 21 — Design: Color and Composition **3.0 Units**

(C-ID ARTS 270) Degree Applicable, CSU, UC

Prerequisite: ARTD 20

Color theory and relationships of pigment and light applied to design and composition as used by all disciplines of the arts.

44295	TTh	1:15pm - 2:05pm	Wasson, S	1A-3
and TTh		2:15pm - 4:25pm	Wasson, S	1A-3

■ ARTD 23A — Drawing: Head and Hands **1.5 Units**

Degree Applicable, CSU, UC

Prerequisite: ARTD 15A or ANIM 104

Contemporary and traditional approaches to drawing the human head and hands.

43987	F	8:00am - 8:50am	Brown, R	1A-7
and F		9:00am - 11:20am	Brown, R	1A-7

■ ARTD 23C — Drawing: Expressive Heads and Hands **1.5 Units**

Degree Applicable

Prerequisite: ARTD 23A

Explores contemporary and traditional approaches to drawing the head and hands, emphasis on media exploration.

43990	F	8:00am - 8:50am	Brown, R	1A-7
and F		9:00am - 11:20am	Brown, R	1A-7

■ ARTD 25A — Beginning Painting I **3.0 Units**

(C-ID ARTS 210) Degree Applicable, CSU, UC

Development of basic paint applications focusing on the formal elements of composition, light logic, and color.

43997	MW	8:00am - 8:50am	Ramos, J	1B/C-6
and MW		9:00am - 11:10am	Ramos, J	1B/C-6
43991	TTh	9:45am - 10:35am	Pedersen, K	1B/C-6
and TTh		10:45am - 12:55pm	Pedersen, K	1B/C-6
43992	MW	11:30am - 12:20pm	Benner Davis, C	1B/C-6
and MW		12:30pm - 2:40pm	Benner Davis, C	1B/C-6
43994	TTh	1:15pm - 2:05pm	Pedersen, K	1B/C-6
and TTh		2:15pm - 4:25pm	Pedersen, K	1B/C-6
43995	MW	3:30pm - 4:20pm	Pedersen, K	1B/C-6
and MW		4:30pm - 6:40pm	Pedersen, K	1B/C-6
43996	TTh	7:00pm - 7:50pm	Clapp, D	1B/C-6
and TTh		8:00pm - 10:10pm	Clapp, D	1B/C-6

■ ARTD 25B — Beginning Painting II **3.0 Units**

Degree Applicable, CSU, UC

Prerequisite: ARTD 25A

Creation of large paintings through various styles including mixed media.

43999	TTh	9:45am - 10:35am	Pedersen, K	1B/C-6
and TTh		10:45am - 12:55pm	Pedersen, K	1B/C-6
44000	MW	11:30am - 12:20pm	Benner Davis, C	1B/C-6
and MW		12:30pm - 2:40pm	Benner Davis, C	1B/C-6
44001	TTh	1:15pm - 2:05pm	Pedersen, K	1B/C-6
and TTh		2:15pm - 4:25pm	Pedersen, K	1B/C-6
44002	TTh	7:00pm - 7:50pm	Clapp, D	1B/C-6
and TTh		8:00pm - 10:10pm	Clapp, D	1B/C-6

■ ARTD 26A — Intermediate Painting I **3.0 Units**

Degree Applicable, CSU, UC

Prerequisite: ARTD 25B

Creation of large works focusing on conceptual issues and art historical influences.

44004	TTh	9:45am - 10:35am	Pedersen, K	1B/C-6
and TTh		10:45am - 12:55pm	Pedersen, K	1B/C-6
44005	MW	11:30am - 12:20pm	Benner Davis, C	1B/C-6
and MW		12:30pm - 2:40pm	Benner Davis, C	1B/C-6
44007	TTh	1:15pm - 2:05pm	Pedersen, K	1B/C-6
and TTh		2:15pm - 4:25pm	Pedersen, K	1B/C-6
44009	TTh	7:00pm - 7:50pm	Clapp, D	1B/C-6
and TTh		8:00pm - 10:10pm	Clapp, D	1B/C-6

■ ARTD 26B — Intermediate Painting II **3.0 Units**

Degree Applicable, CSU, UC

Prerequisite: ARTD 26A

Development of a personal style focusing on conceptual issues and art historical influences.

44011	TTh	9:45am - 10:35am	Pedersen, K	1B/C-6
and TTh		10:45am - 12:55pm	Pedersen, K	1B/C-6
44012	MW	11:30am - 12:20pm	Benner Davis, C	1B/C-6
and MW		12:30pm - 2:40pm	Benner Davis, C	1B/C-6
44014	TTh	1:15pm - 2:05pm	Pedersen, K	1B/C-6
and TTh		2:15pm - 4:25pm	Pedersen, K	1B/C-6
44016	TTh	7:00pm - 7:50pm	Clapp, D	1B/C-6
and TTh		8:00pm - 10:10pm	Clapp, D	1B/C-6

■ ARTD 27 — Painting: Watercolor **3.0 Units**

Degree Applicable, CSU, UC

(May be taken for option of Letter grade or Pass/NoPass)

Prerequisite: ARTD 15A OR ARTD 20 OR ARTD 25A

Watercolor techniques as they relate to compositional and technical processes in painting. Off-campus assignments may be required.

43975	MW	11:30am - 12:20pm	Butler, T	1B/C-5
and MW		12:30pm - 2:40pm	Butler, T	1B/C-5

■ ARTD 43A — Introduction to Printmaking **3.0 Units**

Degree Applicable, CSU, UC

Creative techniques in fine art printmaking using relief and intaglio processes. Field trips may be required.

44017	MW	3:00pm - 3:50pm	Hagner, D	1A-1A1
and MW		4:00pm - 6:10pm	Hagner, D	1A-1A1

■ ARTD 43B — Intermediate Printmaking in Intaglio and Relief **3.0 Units**

Degree Applicable, CSU, UC

(May be taken for option of Letter grade or Pass/NoPass)

Prerequisite: ARTD 43A

Creation of complex editioned color prints in relief and intaglio printmaking from multiple matrices. Field trips may be required.

44019	MW	3:00pm - 3:50pm	Hagner, D	1A-1A1
and MW		4:00pm - 6:10pm	Hagner, D	1A-1A1

■ ARTD 45A — Printmaking: Introduction to Screenprinting **3.0 Units**

Degree Applicable, CSU, UC

Techniques in screenprint printmaking. Aesthetics, historical context, role in contemporary society. Field trips may be required.

44020	TTh	3:00pm - 3:50pm	Cheng, J	1A-1A1
and TTh		4:00pm - 6:10pm	Cheng, J	1A-1A1

■ **ARTD 45B — Printmaking: Intermediate Screenprinting** **3.0 Units**
Degree Applicable, CSU, UC

(May be taken for option of Letter grade or Pass/NoPass)

Prerequisite: ARTD 45A

Complex multi-color registration in screenprinting. Field trips may be required.

44022	TTh	3:00pm - 3:50pm	STAFF	1A-1A1
and	TTh	4:00pm - 6:10pm	STAFF	1A-1A1

■ **ARTD 48A — Letterpress Book Arts** **3.0 Units**
Degree Applicable, CSU

Personal vision and concepts applied to the book form as contemporary art. Field trips may be required.

44024	TTh	11:30am - 12:20pm	Hagner, D	1A-1A1
and	TTh	12:30pm - 2:40pm	Hagner, D	1A-1A1

ART HISTORY

■ **AHIS 1 — Understanding the Visual Arts** **3.0 Units**
Degree Applicable, CSU, UC

Prerequisite: Eligibility for ENGL 68

Visual art forms and role of art in history, culture; off-campus trips possible. Credit not given for both ARTB 1 and AHIS 1

44084	MW	8:00am - 9:25am	Duffield, K	26D-2411
44076	TTh	8:00am - 9:25am	Staylor, D	26D-2220
44077	MW	9:45am - 11:10am	Hruby, S	26D-2411
44082	F	9:45am - 12:55pm	Caldwell, E	26D-2220
44078	MW	1:15pm - 2:40pm	Duffield, K	26D-2411
44079	TTh	1:15pm - 2:40pm	Byce, J	26D-2220
44085	TTh	3:00pm - 4:25pm	Salomone, T	26D-2220
44089		arrange 6.75 hours	Caldwell, E	ONLINE

8 Weeks, Week beginning 02/26/2018 ending 04/22/2018

NOTE: CRN 44089 is a Distance Learning Online Class.

Other Course Requirements: Three museum visits are required.

How to Begin Course: Log into Canvas through <http://myportal.mtsac.edu> and click on CRN for your DL course. **NOTE:** Some courses may not be activated until the start of the term. If you cannot locate your DL course in Canvas when the term starts, contact the professor. **On the first day of classes, log into your DL course to show your "attendance" because not doing so could result in your being dropped from the class for non-attendance.**

Professor contact info: Email Professor Caldwell at either: ECaldwell1@mtsac.edu, through Student Detail Schedule or Canvas at MyMtSAC Portal.

Students must use their Mt. SAC e-mail account and be aware of course commitment and student expectations described at <http://www.mtsac.edu/instruction/learning/distlearn/>

To prepare for a successful online learning experience, see helpful short videos at <http://www.mtsac.edu/distancelearning/quiz/>

44090		arrange 6.75 hours	Caldwell, E	ONLINE
-------	--	--------------------	-------------	--------

8 Weeks, Week beginning 04/23/2018 ending 06/17/2018

NOTE: CRN 44090 is a Distance Learning Online Class.

Other Course Requirements: Three museum visits are required.

How to Begin Course: Log into Canvas through <http://myportal.mtsac.edu> and click on CRN for your DL course. **NOTE:** Some courses may not be activated until the start of the term. If you cannot locate your DL course in Canvas when the term starts, contact the professor. **On the first day of classes, log into your DL course to show your "attendance" because not doing so could result in your being dropped from the class for non-attendance.**

Professor contact info: Email Professor Caldwell at either: ECaldwell1@mtsac.edu, through Student Detail Schedule or Canvas at MyMtSAC Portal.

Students must use their Mt. SAC e-mail account and be aware of course commitment and student expectations described at <http://www.mtsac.edu/instruction/learning/distlearn/>

To prepare for a successful online learning experience, see helpful short videos at <http://www.mtsac.edu/distancelearning/quiz/>

■ **AHIS 3 — History of Women and Gender in Art** **3.0 Units**
Degree Applicable, CSU, UC

Prerequisite: Eligibility for ENGL 68

Roles of women and gender in cultural creation and production with a focus on the visual arts.

44095	TTh	1:15pm - 2:40pm	Caldwell, E	26D-2411
-------	-----	-----------------	-------------	----------

■ **AHIS 3H — History of Women and Gender in Art - Honors** **3.0 Units**
Degree Applicable, CSU, UC

Prerequisite: Acceptance into the Honors Program

An honors course designed to provide an enriched experience. May not receive credit for both AHIS 3 (formerly ARTA 3) and AHIS 3H.

44096	TTh	9:45am - 11:10am	Caldwell, E	26D-2220
-------	-----	------------------	-------------	----------

■ **AHIS 4 — History of Western Art: Prehistoric Through Gothic** **3.0 Units**

(C-ID ARTH 110) Degree Applicable, CSU, UC

Prerequisite: Eligibility for ENGL 68

Western art from Prehistoric through Gothic periods; relationship of visual art forms to each other and to the cultural context.

44098	MW	9:45am - 11:10am	Martin, D	26D-2220
44099	TTh	9:45am - 11:10am	Hernandez, C	26D-2411
44100	W	02/28 3:00pm - 4:00pm	Hernandez, C	26D-2220
		and arrange 6.75 hours	Hernandez, C	ONLINE

8 Weeks, Week beginning 02/26/2018 ending 04/22/2018

NOTE: CRN 44100 is a Hybrid Class taught partially online with a Scheduled Meeting on Campus.

Course Orientation: Course orientation scheduled above is mandatory. If student cannot attend orientation, student must contact professor before orientation meeting to avoid being dropped from class.

Other Course Requirements: One museum visit is required.

How to Begin Course: Log into Canvas through <http://myportal.mtsac.edu> and click on CRN for your DL course. **NOTE:** Some courses may not be activated until the start of the term. If you cannot locate your DL course in Canvas when the term starts, contact the professor. **On the first day of classes, log into your DL course to show your "attendance" because not doing so could result in your being dropped from the class for non-attendance.**

Professor contact info: Email Professor Hernandez at either: CHernandez@mtsac.edu, through Student Detail Schedule or Canvas at MyMtSAC Portal.

Students must use their Mt. SAC e-mail account and be aware of course commitment and student expectations described at <http://www.mtsac.edu/instruction/learning/distlearn/>

To prepare for a successful online learning experience, see helpful short videos at <http://www.mtsac.edu/distancelearning/quiz/>

44101	W	04/25 3:00pm - 4:00pm	Hernandez, C	26D-2220
		and arrange 6.75 hours	Hernandez, C	ONLINE

8 Weeks, Week beginning 04/23/2018 ending 06/17/2018

NOTE: CRN 44101 is a Hybrid Class taught partially online with a Scheduled Meeting on Campus.

Course Orientation: Course orientation scheduled above is mandatory. If student cannot attend orientation, student must contact professor before orientation meeting to avoid being dropped from class.

Other Course Requirements: One museum visit is required.

How to Begin Course: Log into Canvas through <http://myportal.mtsac.edu> and click on CRN for your DL course. **NOTE:** Some courses may not be activated until the start of the term. If you cannot locate your DL course in Canvas when the term starts, contact the professor. **On the first day of classes, log into your DL course to show your "attendance" because not doing so could result in your being dropped from the class for non-attendance.**

Professor contact info: Email Professor Hernandez at either: CHernandez@mtsac.edu, through Student Detail Schedule or Canvas at MyMtSAC Portal.

Students must use their Mt. SAC e-mail account and be aware of course commitment and student expectations described at <http://www.mtsac.edu/instruction/learning/distlearn/>

To prepare for a successful online learning experience, see helpful short videos at <http://www.mtsac.edu/distancelearning/quiz/>

■ AHIS 5 — History of Western Art: Renaissance Through Modern **3.0 Units**

(C-ID ARTH 120) Degree Applicable, CSU, UC

Prerequisite: Eligibility for ENGL 68

History of Renaissance through Modern art in cultural context. Off campus assignments may be required.

44103	MW	11:30am - 12:55pm	Duffield, K	26D-2411
44104	TTh	11:30am - 12:55pm	Byce, J	26D-2220
44105	M	02/26 3:00pm - 4:00pm and arrange 6.75 hours	Hight, D	26D-2220 ONLINE

8 Weeks, Week beginning 02/26/2018 ending 04/22/2018
NOTE: CRN 44105 is a Hybrid Class taught partially online with a Scheduled Meeting on Campus.

Course Orientation: Course orientation scheduled above is mandatory. If student cannot attend orientation, student must contact professor before orientation meeting to avoid being dropped from class.

Other Course Requirements: One museum visit is required.

How to Begin Course: Log into Canvas through <http://myportal.mtsac.edu> and click on CRN for your DL course. **NOTE:** Some courses may not be activated until the start of the term. If you cannot locate your DL course in Canvas when the term starts, contact the professor. **On the first day of classes, log into your DL course to show your "attendance" because not doing so could result in your being dropped from the class for non-attendance.**
Professor contact info: Email Professor Hight at either: DHight@mtsac.edu, through Student Detail Schedule or Canvas at MyMtSAC Portal.

Students must use their Mt. SAC e-mail account and be aware of course commitment and student expectations described at <http://www.mtsac.edu/instruction/learning/distlearn/>

 To prepare for a successful online learning experience, see helpful short videos at <http://www.mtsac.edu/distancelearning/quiz/>

44106	M	04/23 3:00pm - 4:00pm and arrange 6.75 hours	Hight, D	26D-2220 ONLINE
-------	---	---	----------	--------------------

8 Weeks, Week beginning 04/23/2018 ending 06/17/2018
NOTE: CRN 44106 is a Hybrid Class taught partially online with a Scheduled Meeting on Campus.

Course Orientation: Course orientation scheduled above is mandatory. If student cannot attend orientation, student must contact professor before orientation meeting to avoid being dropped from class.

Other Course Requirements: One museum visit is required.

How to Begin Course: Log into Canvas through <http://myportal.mtsac.edu> and click on CRN for your DL course. **NOTE:** Some courses may not be activated until the start of the term. If you cannot locate your DL course in Canvas when the term starts, contact the professor. **On the first day of classes, log into your DL course to show your "attendance" because not doing so could result in your being dropped from the class for non-attendance.**
Professor contact info: Email Professor Hight at either: DHight@mtsac.edu, through Student Detail Schedule or Canvas at MyMtSAC Portal.

Students must use their Mt. SAC e-mail account and be aware of course commitment and student expectations described at <http://www.mtsac.edu/instruction/learning/distlearn/>

 To prepare for a successful online learning experience, see helpful short videos at <http://www.mtsac.edu/distancelearning/quiz/>

44102	T	5:15pm - 8:25pm	Salomone, T	26D-2220
-------	---	-----------------	-------------	----------

■ AHIS 6 — History of Modern Art **3.0 Units**

Degree Applicable, CSU, UC

Prerequisite: Eligibility for ENGL 68

Artistic movements, influences, and individuals forming the Modern tradition. Off campus trips may be required.

44107	MW	11:30am - 12:55pm	Martin, D	26D-2220
44108	Th	5:15pm - 8:25pm	Salomone, T	26D-2220

■ AHIS 10 — A History of Greek and Roman Art and Architecture **3.0 Units**

Degree Applicable, CSU, UC

Advisory: Eligibility for ENGL 68

A critical history of Greek and Roman art and architecture before 500 CE in cultural context and influences on Europe and America.

44091	MW	8:00am - 9:25am	Hight, D	26D-2220
-------	----	-----------------	----------	----------

■ AHIS 14 — Rome: The Ancient City **3.0 Units**

Degree Applicable, CSU, UC

Prerequisite: Eligibility for ENGL 68

The art and culture of ancient city of Rome.

44093	TTh	1:15pm - 2:40pm	Edson, T	26A-1821
-------	-----	-----------------	----------	----------

■ AHIS 15 — Culture and Art of Pompeii **3.0 Units**

Degree Applicable, CSU, UC

Prerequisite: Eligibility for ENGL 1A

Art, architecture, and culture of Pompeii and nearby cities destroyed in the volcanic eruption of 79 CE studied in context.

44094	TTh	11:30am - 12:55pm	Hernandez, C	26D-2411
-------	-----	-------------------	--------------	----------

ASTRONOMY
■ ASTR 5 — Introduction to Astronomy **3.0 Units**

Degree Applicable, CSU, UC

Prerequisite: Eligibility for ENGL 1A

Introductory survey of the Universe. Enroll in ASTR 5L to receive laboratory science credit. Field trips may be required.

41885	MW	8:00am - 9:25am	Virji, S	11-2119
41886	MW	9:45am - 11:10am	Virji, S	11-2119
41888	TTh	9:45am - 11:10am	Hood, M	11-2119
41887	Th	9:45am - 12:55pm	Christopher, M	60-1306

NOTE: ASTR 5 (CRN 41887) is linked to ASTR 5L (CRN 41986). If you want to register for CRN 41887 you must enter both CRNS (41887 and 41986) in the registration screen. Please call the Natural Sciences Division at (909) 274-4425 if you have any questions.

41928	MW	11:30am - 12:55pm	Virji, S	11-2119
41962	TTh	11:30am - 12:55pm	Hood, M	11-2119
41971	MW	1:15pm - 2:40pm	STAFF	11-2119
41972	TTh	1:15pm - 2:40pm	Hood, M	11-2119
41978	T	3:00pm - 6:10pm	STAFF	11-2119
41970	T	02/27 1:05pm - 2:55pm	Christopher, M	61-3410
	and T	03/20 1:05pm - 2:55pm and arrange 3 hours	Christopher, M	61-3410 ONLINE

NOTE: CRN 41970 is a 16-week Hybrid Class taught partially online with Schedule Meetings on Campus.

How to Begin Course: Log into Moodlerooms through the eLearning Tools tab in the Mt. SAC portal at my.mtsac.edu. Click on the Moodlerooms link and then click on the CRN for your DL course. **NOTE:** Some courses may not be activated until the start of the term. If you cannot locate your DL course in Moodlerooms when the term starts, contact the professor.

Professor contact info: Email Professor M. Christopher at either: mchristopher@mtsac.edu, through Student Detail Schedule or Moodlerooms at MyMtSAC Portal.

Students must use their Mt. SAC e-mail account and be aware of course commitments and student expectations described at <http://www.mtsac.edu/instruction/learning/distlearn/>

41984	W	6:30pm - 9:40pm	STAFF	11-2119
-------	---	-----------------	-------	---------

■ ASTR 5H — Introduction to Astronomy - Honors				3.0 Units
Degree Applicable, CSU, UC				
<i>Prerequisite: Eligibility for ENGL 1A; Acceptance into the Honors Program</i>				
Introductory survey of the Universe - Honors. Enroll in ASTR 5L to receive laboratory science credit. Field trips may be required.				
41987	F	9:00am - 12:10pm	Christopher, M	11-2119

■ ASTR 5L — Astronomical Observing Laboratory				1.0 Unit
Degree Applicable, CSU, UC				

Corequisite: ASTR 5 or ASTR 5H or ASTR 7 or ASTR 8 (May have been taken previously)

Advisory: MATH 51

Lab and field applications and problem-solving in astronomy. Required evening observing sessions and/or field trips.

41889	M	9:45am - 12:55pm	Hood, M	60-1306
41890	T	9:45am - 12:55pm	Christopher, M	60-1306
41891	W	9:45am - 12:55pm	Hood, M	60-1306
41892	M	1:15pm - 4:25pm	Bray-Ali, F	60-1306
41893	T	1:15pm - 4:25pm	Bray-Ali, F	60-1306
41894	W	1:15pm - 4:25pm	Hood, M	60-1306
41986	Th	3:00pm - 6:10pm	Christopher, M	60-1306

NOTE: ASTR 5L (CRN 41986) is linked to ASTR 5 (CRN 41887). If you want to register for CRN 41986 you must enter both CRNS (41986 and 41887) in the registration screen. Please call the Natural Sciences Division at (909) 274-4425 if you have any questions.

■ ASTR 7 — Geology of the Solar System				3.0 Units
Degree Applicable, CSU, UC				

Geological features and evolution in the solar system. Enroll in ASTR 5L to receive lab science credit. Field trips are required.

41895	MW	8:00am - 9:25am	Boryta, M	61-1420
43370	MW	11:30am - 12:55pm	Boryta, M	11-2115
43372	T	1:10pm - 4:20pm	Phelps, S	11-2115
43371	MW	1:15pm - 2:40pm	STAFF	11-2115
43373	F	1:15pm - 4:25pm	Phelps, S	61-1420
43374	T	6:30pm - 9:40pm	Phelps, S	61-1420

■ ASTR 8 — Introduction to Stars, Galaxies, and the Universe				3.0 Units
Degree Applicable, CSU, UC				

Structure and evolution of stars, galaxies, and universe. Enroll in ASTR 5L to receive lab science credit. Field trips required.

44225	TTh	8:00am - 9:25am	STAFF	61-1420
41896	MW	9:45am - 11:10am	Bray-Ali, F	61-1420
44226	TTh	9:45am - 11:10am	STAFF	61-1420
41897	MW	11:30am - 12:55pm	Bray-Ali, F	61-1420
41974		arrange 3.2 hours	Bray-Ali, F	ONLINE

NOTE: CRN 41974 is a 16-week Distance Learning course with no meetings on campus.

How to Begin Course: Log into Moodlerooms through the eLearning Tools tab in the Mt. SAC portal at my.mtsac.edu. Click on the Moodlerooms link and then click on the CRN for your DL course. **NOTE:** Some courses may not be activated until the start of the term. If you cannot locate your DL course in Moodlerooms when the term starts, contact the professor.

Professor contact info: Email Professor M. Christopher at either: jbray-ali@mtsac.edu, through Student Detail Schedule or Moodlerooms at MyMtSAC Portal.

Students must use their Mt. SAC e-mail account and be aware of course commitments and student expectations described at <http://www.mtsac.edu/instruction/learning/distlearn/>

■ ASTR 99 — Special Projects in Astronomy				2.0 Units
Degree Applicable, CSU				

Offers students the opportunity to explore the discipline in greater depth. Instructor authorization needed prior to enrollment.

41923	T	3:00pm - 5:10pm	Jones, H	TBA
41980	W	3:00pm - 5:10pm	Jones, H	TBA

BIOLOGY

■ BIOL 1 — General Biology				4.0 Units
Degree Applicable, CSU, UC				

Prerequisite: Eligibility for ENGL 68

Advisory: READ 90

Major principles and concepts of biology for the non-science major.

41689	MW	8:00am - 9:25am	Scott, S	11-2402
and M	9:45am - 12:55pm	Scott, S	7-1108	
41690	MW	8:00am - 9:25am	Scott, S	11-2402
and W	9:45am - 12:55pm	Scott, S	7-1108	
41721	M	8:00am - 11:10am	Spitzer, J	11-2312
and W	8:00am - 11:10am	STAFF	7-1111	
41779	T	8:00am - 11:10am	STAFF	61-2320
and Th	8:00am - 11:10am	STAFF	7-1111	
41780	T	8:00am - 11:10am	Mc Cabe, D	61-2320
and Th	8:00am - 11:10am	STAFF	7-1115	
41691	TTh	8:00am - 9:25am	Ngo, J	11-2402
and T	9:45am - 12:55pm	Ngo, J	7-1108	
41692	TTh	8:00am - 9:25am	Ngo, J	11-2402
and Th	9:45am - 12:55pm	Ngo, J	7-1108	
41703	WF	8:00am - 9:25am	Rothman, S	61-2320
and F	9:45am - 12:55pm	STAFF	7-1108	
41704	WF	8:00am - 9:25am	Rothman, S	61-2320
and F	9:45am - 12:55pm	STAFF	7-1115	
41693	MW	9:45am - 11:10am	Hollenshead, M	61-2320
and M	12:00pm - 3:10pm	Hollenshead, M	7-1111	
41694	MW	9:45am - 11:10am	Hollenshead, M	61-2320
and W	12:00pm - 3:10pm	Hollenshead, M	7-1111	
41720	M	9:45am - 12:55pm	Revell, T	7-1115
		3.4 hours	Revell, T	ONLINE
41697	TTh	9:45am - 11:10am	Kido, J	11-2402
and T	11:30am - 2:40pm	Kido, J	7-1111	
41698	TTh	9:45am - 11:10am	Kido, J	11-2402
and Th	11:30am - 2:40pm	Kido, J	7-1111	
41699	MW	11:30am - 12:55pm	Schmidt, S	11-2402
and M	1:15pm - 4:25pm	Schmidt, S	7-1115	
41700	MW	11:30am - 12:55pm	Schmidt, S	11-2402
and W	1:15pm - 4:25pm	Schmidt, S	7-1115	
41701	TTh	11:30am - 12:55pm	Briggs, C	61-2320
and T	1:45pm - 4:55pm	Briggs, C	7-1108	
41702	TTh	11:30am - 12:55pm	Briggs, C	61-2320
and Th	1:45pm - 4:55pm	Briggs, C	7-1108	
41713	TTh	11:30am - 12:55pm	Flisik, T	11-2402
and T	1:45pm - 4:55pm	Flisik, T	7-1115	
41714	TTh	11:30am - 12:55pm	Flisik, T	11-2402
and Th	1:45pm - 4:55pm	Flisik, T	7-1115	
41794	WF	11:30am - 12:55pm	STAFF	61-2320
and F	1:15pm - 4:25pm	STAFF	7-1111	
41795	WF	11:30am - 12:55pm	STAFF	61-2320
and F	8:00am - 11:10am	STAFF	7-1111	
41705	MW	1:15pm - 2:40pm	Kakiba-Russell, K	61-2320
and M	3:30pm - 6:40pm	STAFF	7-1111	
41706	MW	1:15pm - 2:40pm	Kakiba-Russell, K	61-2320
and W	3:30pm - 6:40pm	STAFF	7-1111	
41707	TTh	1:15pm - 2:40pm	Kinnes, S	61-2320
and T	3:30pm - 6:40pm	STAFF	7-1111	
41708	TTh	1:15pm - 2:40pm	Kinnes, S	61-2320
and Th	3:30pm - 6:40pm	STAFF	7-1111	
41695	MW	3:30pm - 4:55pm	Blacquiere, L	11-2402
and M	5:15pm - 8:25pm	Blacquiere, L	7-1115	
41696	MW	3:30pm - 4:55pm	Blacquiere, L	11-2402
and W	5:15pm - 8:25pm	Blacquiere, L	7-1115	
41709	TTh	3:30pm - 4:55pm	STAFF	61-2320
and T	5:15pm - 8:25pm	STAFF	7-1108	

41710	TTh	3:30pm - 4:55pm	STAFF	7-1115
and T		5:15pm - 8:25pm	STAFF	
41787	WF	3:30pm - 4:55pm	STAFF	61-2320
and W		5:15pm - 8:25pm	STAFF	7-1108
41789	WF	3:30pm - 4:55pm	STAFF	61-2320
and F		5:15pm - 8:25pm	STAFF	7-1111
41711	MW	5:15pm - 6:40pm	Jayachandran, S	11-2402
and M		7:00pm - 10:10pm	Jayachandran, S	7-1111
41712	MW	5:15pm - 6:40pm	Jayachandran, S	11-2402
and W		7:00pm - 10:10pm	Jayachandran, S	7-1111
41807	M	5:15pm - 8:25pm	Revell, T	7-1108
	and arrange	3.4 hours	Revell, T	ONLINE
41715	TTh	5:15pm - 6:40pm	Bava, J	61-2320
and T		7:00pm - 10:10pm	Bava, J	7-1111
41716	TTh	5:15pm - 6:40pm	Bava, J	61-2320
and Th		7:00pm - 10:10pm	Bava, J	7-1111
41717	T	7:00pm - 10:10pm	STAFF	61-2320
and Th		7:00pm - 10:10pm	STAFF	7-1108
41718	T	7:00pm - 10:10pm	STAFF	61-2320
and Th		7:00pm - 10:10pm	STAFF	7-1115
41719	F	7:00pm - 10:10pm	Drakou-Sarantopoul, H	61-2320
and S		9:45am - 12:55pm	Rozar, R	7-1111
41806	F	7:00pm - 10:10pm	Drakou-Sarantopoul, H	61-2320
and S		1:15pm - 4:25pm	Rozar, R	7-1111

BIOL 2 — Plant and Animal Biology **4.0 Units**
Degree Applicable, CSU, UC

Prerequisite: BIOL 1 or BIOL 4; and MATH 71

Organismal biology, plant and animal physiology, ecology, and biotic relationships. Field trips are required.

41731	MW	1:15pm - 2:40pm	Cooper, M	7-1104
and W		3:00pm - 6:10pm	Cooper, M	7-1121
41775	MW	1:15pm - 2:40pm	Cooper, M	7-1104
and W		9:45am - 12:55pm	Cooper, M	7-1121
41729	TTh	1:15pm - 2:40pm	Cooper, M	7-1104
and Th		9:45am - 12:55pm	Cooper, M	7-1121
41730	TTh	1:15pm - 2:40pm	Cooper, M	7-1104
and Th		3:00pm - 6:10pm	Cooper, M	7-1121
41776	MW	4:45pm - 6:10pm	Flisik, T	11-2312
and W		6:30pm - 9:40pm	Flisik, T	7-1121

BIOL 3 — Ecology and Field Biology **4.0 Units**
Degree Applicable, CSU, UC

Advisory: Eligibility for ENGL 1A

Identification and ecological relationships of local plants and animals. Hiking, one weekend and other field trips required.

41739	M	9:45am - 12:55pm	Shannon, C	7-1121
and W		9:45am - 12:55pm	Shannon, C	11-2312
41740	T	9:45am - 12:55pm	Shannon, C	7-1121
and Th		9:45am - 12:55pm	Shannon, C	11-2312

BIOL 4 — Biology for Majors **4.0 Units**
Degree Applicable, CSU, UC

Prerequisite: (CHEM 10 or CHEM 40) AND MATH 71

Advisory: Eligibility for ENGL 1A

General biology for science majors. Principles of biology required for advanced study. Field trips with extensive hiking required.

44068	W	8:00am - 11:10am	STAFF	11-2406
and F		8:00am - 12:15pm	STAFF	60-2628
41742	M	8:30am - 12:45pm	Churchill, D	60-2628
and MW		1:15pm - 2:40pm	Mirman, D	7-1120
41743	T	8:30am - 12:45pm	Churchill, D	60-2628
and TTh		1:15pm - 2:40pm	Churchill, D	11-2312
41793	MW	1:15pm - 2:40pm	Mirman, D	7-1120
and M		3:00pm - 7:15pm	Kaus, A	60-2628
41744	TTh	1:15pm - 2:40pm	Churchill, D	11-2312
and Th		8:30am - 12:45pm	Churchill, D	60-2628
41746	T	1:30pm - 4:40pm	Shannon, C	7-1120
and Th		1:30pm - 5:45pm	Shannon, C	60-2628
41745	T	5:15pm - 9:30pm	Mc Cabe, D	60-2628
and Th		5:15pm - 8:25pm	Mc Cabe, D	11-2105

BIOL 5 — Contemporary Health Issues **3.0 Units**
Degree Applicable, CSU, UC

Contemporary health issues known to affect the quality and longevity of life with emphasis on prevention of illness and injuries.

41747	MW	9:45am - 11:10am	Ito Rocha Santana, N	11-2105
41748	TTh	9:45am - 11:10am	Ito Rocha Santana, N	11-2105
41777	M	7:00pm - 10:10pm	Crocker, C	11-2105
41749		arrange 3.4 hours	Crocker, C	ONLINE

BIOL 6 — Humans and the Environment **3.0 Units**
Degree Applicable, CSU, UC

Prerequisite: Eligibility for ENGL 68

Ecological concepts to aid understanding our environmental crisis.

41750	MW	9:45am - 12:55pm	Kakiba-Russell, K	7-1205
		16 Weeks, Week beginning 02/26/2018 ending 04/22/2018		
41751	MW	9:45am - 12:55pm	Kakiba-Russell, K	7-1205
		16 Weeks, Week beginning 04/23/2018 ending 06/17/2018		
41752	TTh	9:45am - 11:10am	Petersen, C	7-1205
41753	TTh	11:30am - 12:55pm	Petersen, C	7-1205
41754	Th	1:15pm - 4:25pm	Petersen, C	7-1205
41755	T	7:00pm - 10:10pm	Petersen, C	7-1205

BIOL 6L — Humans and the Environment Laboratory **2.0 Units**
Degree Applicable, CSU, UC

Prerequisite: BIOL 6 (may be taken concurrently)

Investigates problems discussed in BIOL 6. Significant walking at off-campus sites and one weekend field trip required.

41757	W	1:15pm - 6:40pm	Petersen, C	7-1205
	and arrange	1 hour	Petersen, C	7-1205

BIOL 8 — Cell and Molecular Biology **4.0 Units**
Degree Applicable, CSU, UC

Prerequisite: BIOL 4 or BIOL 4H, and CHEM 50

Cell and molecular biology with lab emphasizing molecular concepts.

41758	MW	1:15pm - 2:40pm	Wright, C	11-2406
and W		9:45am - 12:55pm	Mirman, D	60-2628
41759	MW	1:15pm - 2:40pm	Wright, C	11-2406
and W		3:00pm - 6:10pm	Wright, C	60-2628
43686	MW	5:15pm - 6:40pm	Meyer, E	11-2105
and W		7:00pm - 10:10pm	Meyer, E	60-2628

BIOL 13 — Human Reproduction, Development and Aging **3.0 Units**
Degree Applicable, CSU, UC

Prerequisite: Eligibility for ENGL 68

Human development from conception to death. Field trips required.

41722	TTh	9:45am - 11:10am	Meyer, E	7-1209
-------	-----	------------------	----------	--------

BIOL 15 — Human Sexuality **3.0 Units**
Degree Applicable, CSU, UC

Prerequisite: Eligibility for ENGL 68

Surveys biological, behavioral, cultural and ethical aspects of human sexuality. Contains mature and sexually explicit content.

41723	MW	9:45am - 11:10am	Petersen, C	7-1209
41724	MW	11:30am - 12:55pm	Ito Rocha Santana, N	7-1209
41726	TTh	11:30am - 12:55pm	De La Rosa, D	7-1209
41725	TTh	1:15pm - 2:40pm	De La Rosa, D	7-1209
41782	MW	1:45pm - 3:10pm	Ito Rocha Santana, N	7-1209
41790	T	7:00pm - 10:10pm	Butler, J	7-1209

BIOL 17 — Neurobiology and Behavior **3.0 Units**
Degree Applicable, CSU, UC

An integrated analysis of the biological, ecological and evolutionary bases of animal behavior (ethology). Field trip required.

41728	T	3:00pm - 6:10pm	Revell, T	11-2312
-------	---	-----------------	-----------	---------

BIOL 20 — Marine Biology **3.0 Units**

Degree Applicable, CSU, UC

The marine environment including the principles of marine science. Field trip required.

41732	MW	8:00am - 9:25am	STAFF	7-1205
41733	TTh	8:00am - 9:25am	Whitlow, L	7-1205
41805	MW	9:45am - 11:10am	STAFF	7-1120
41809	TTh	11:30am - 12:55pm	Whitlow, L	7-1120
41734	MW	1:15pm - 2:40pm	Kido, J	11-2105
41735	MW	3:00pm - 4:25pm	Flisik, T	11-2312
41786	TTh	3:00pm - 4:25pm	Whitlow, L	7-1104

BIOL 21 — Marine Biology Laboratory **1.0 Unit**

Degree Applicable, CSU, UC

Corequisite: BIOL 20 (May have been taken previously)

Field and laboratory aspects of the marine environment. Field trips are required.

41736	T	9:45am - 12:55pm	Schmidt, S	7-1115
41737	W	9:45am - 12:55pm	Kido, J	7-1115

BIOL 34 — Fundamentals of Genetics **3.0 Units**

Degree Applicable, CSU, UC

Prerequisite: BIOL 4 or BIOL 4H

Theory and applications of Mendelian and molecular genetics.

41741	TTh	11:30am - 12:55pm	Mirman, D	11-2105
-------	-----	-------------------	-----------	---------

BIOL 34L — Fundamentals of Genetics Lab **1.0 Unit**

Degree Applicable, CSU, UC

Corequisite: BIOL 34 (May have been taken previously).

Experiments and problem solving in Mendelian, molecular and population genetics

41791	T	1:15pm - 4:25pm	Mirman, D	60-2628
-------	---	-----------------	-----------	---------

BIOL 99A — Special Projects in Biology **1.0 Unit**

Degree Applicable, CSU

Offers students the opportunity to explore the discipline in greater depth. Instructor authorization needed prior to enrollment.

41798		1.3 hours	STAFF	
41799		1.3 hours	STAFF	
41800		1.3 hours	STAFF	

BIOL 99A — Special Projects in Biology **2.0 Units**

Degree Applicable, CSU

Offers students the opportunity to explore the discipline in greater depth. Instructor authorization needed prior to enrollment.

41783		2.25 hours	STAFF	
41820		2.25 hours	STAFF	

BOTANY**BTNY 3 — Plant Structures, Functions, and Diversity** **5.0 Units**

Degree Applicable, CSU, UC

Advisory: (BIOL 1 or BIOL 4) and Eligibility for ENGL 1A

Structures and functions of plants, fungi, and algae. Students provide own transportation for required off-campus lab meetings.

41760	MW	11:30am - 12:55pm	STAFF	11-2105
	and MW	1:35pm - 4:45pm	STAFF	7-1108

BUSINESS: ACCOUNTING**BUSA 7 — Principles of Accounting - Financial** **5.0 Units**

(C-ID ACCT 110) Degree Applicable, CSU, UC

Prerequisite: BUSA 11 or eligibility for MATH 51

Advisory: Eligibility for ENGL 1A

Financial accounting required of Business Administration and Accounting majors.

40867	MW	7:00am - 9:35am	Little, D	79-3250
40875	TTh	7:00am - 9:35am	Brown, M	79-3250
40868	MW	9:45am - 12:20pm	Truong, P	79-2230
40869	MW	9:45am - 12:20pm	Valdes, S	79-3250
40870	TTh	9:45am - 12:20pm	Domico, B	79-3250
40871	TTh	9:45am - 12:20pm	Valdes, S	79-2230
43947	W	9:45am - 12:20pm	Domico, B	79-2270
		and arrange 2.7 hours	Domico, B	ONLINE

NOTE: CRN 43947 is a Hybrid Class taught partially online with scheduled meetings on campus.

How to Begin Course: Log into Canvas through <http://myportal.mtsac.edu> and click on CRN for your DL course. If cannot locate your DL course in Canvas, contact the professor. **On the first day of classes, log into your DL course to show your "attendance" because not doing so could result in your being dropped from the class for non-attendance.** Professor contact info: Email Professor Domico at either: BDomico@mtsac.edu, through Student Detail Schedule or Canvas at MyMtSAC Portal.

Students must use their Mt. SAC e-mail account and be aware of course commitment and student expectations described at <http://www.mtsac.edu/instruction/learning/distlearn/>

To prepare for a successful online learning experience, see helpful short videos at <http://www.mtsac.edu/distancelearning/quiz/>

40872	MW	12:30pm - 3:05pm	Valdes, S	79-3250
40873	TTh	1:30pm - 4:00pm	Bowers, E	79-3250
40874	MW	7:00pm - 9:35pm	Quintero, H	79-2270
40877	M	7:00pm - 9:35pm	Ildefonso, N	79-3250
		and arrange 2.8 hours	Ildefonso, N	ONLINE

NOTE: CRN 40877 is a Hybrid Class taught partially online with scheduled meetings on campus.

How to Begin Course: Log into Canvas through <http://myportal.mtsac.edu> and click on CRN for your DL course. If cannot locate your DL course in Canvas, contact the professor. **On the first day of classes, log into your DL course to show your "attendance" because not doing so could result in your being dropped from the class for non-attendance.** Professor contact info: Email Professor Ildefonso at either: Nildefonso@mtsac.edu, through Student Detail Schedule or Canvas at MyMtSAC Portal.

Students must use their Mt. SAC e-mail account and be aware of course commitment and student expectations described at <http://www.mtsac.edu/instruction/learning/distlearn/>

To prepare for a successful online learning experience, see helpful short videos at <http://www.mtsac.edu/distancelearning/quiz/>

40876	TTh	7:00pm - 9:35pm	Tambunan, M	79-2270
41175	F	7:00pm - 10:10pm	Hoekstra, T	79-3250
		and arrange 8.25 hours	Hoekstra, T	ONLINE
				8 Weeks, Week beginning 02/26/2018 ending 04/22/2018

NOTE: CRN 41175 is a Hybrid Class taught partially online with scheduled meetings on campus.

How to Begin Course: Log into Canvas through <http://myportal.mtsac.edu> and click on CRN for your DL course. If cannot locate your DL course in Canvas, contact the professor. **On the first day of classes, log into your DL course to show your "attendance" because not doing so could result in your being dropped from the class for non-attendance.**

Professor contact info: Email Professor Hoekstra at either: THoekstra@mtsac.edu, through Student Detail Schedule or Canvas at MyMtSAC Portal.

Students must use their Mt. SAC e-mail account and be aware of course commitment and student expectations described at <http://www.mtsac.edu/instruction/learning/distlearn/>

To prepare for a successful online learning experience, see helpful short videos at <http://www.mtsac.edu/distancelearning/quiz/>

■ **BUSA 8 — Principles of Accounting - Managerial** **5.0 Units**
(C-ID ACCT 120) Degree Applicable, CSU, UC

Prerequisite: BUSA 7

Managerial accounting concepts and principles. Provides the accounting tools and methods needed for decision making in business.

40878	MW	7:00am - 9:35am	Bates, B	79-3230
40879	MW	9:45am - 12:20pm	Mc Geough, D	79-3230
40880	TTh	9:45am - 12:20pm	Bates, B	79-3230
40881	MW	12:30pm - 3:05pm	Mc Geough, D	79-3230
40882	TTh	1:30pm - 4:05pm	Bates, B	79-3230
41265	T	7:00pm - 9:35pm	Ildefonso, N	TBA

and arrange 2.8 hours Ildefonso, N ONLINE

NOTE: CRN 41265 is a Hybrid Class taught partially online with scheduled meetings on campus.

How to Begin Course: Log into Canvas through <http://myportal.mtsac.edu> and click on CRN for your DL course. If cannot locate your DL course in Canvas, contact the professor. On the first day of classes, log into your DL course to show your "attendance" because not doing so could result in your being dropped from the class for non-attendance.

Professor contact info: Email Professor Ildefonso at either: Nildefonso@mtsac.edu, through Student Detail Schedule or Canvas at MyMtSAC Portal.

Students must use their Mt. SAC e-mail account and be aware of course commitment and student expectations described at <http://www.mtsac.edu/instruction/learning/distlearn/>

To prepare for a successful online learning experience, see helpful short videos at <http://www.mtsac.edu/distancelearning/quiz/>

40884	TTh	7:00pm - 9:35pm	Bowers, E	79-3250
40883	W	7:00pm - 9:35pm	STAFF	79-3250

and arrange 2.75 hours STAFF ONLINE

NOTE: CRN 40883 is a Hybrid Class taught partially online with scheduled meetings on campus.

How to Begin Course: Log into Canvas through <http://myportal.mtsac.edu> and click on CRN for your DL course. If cannot locate your DL course in Canvas, contact the professor. On the first day of classes, log into your DL course to show your "attendance" because not doing so could result in your being dropped from the class for non-attendance.

Professor contact info: Email Professor STAFF at either: STAFF@mtsac.edu, through Student Detail Schedule or Canvas at MyMtSAC Portal.

Students must use their Mt. SAC e-mail account and be aware of course commitment and student expectations described at <http://www.mtsac.edu/instruction/learning/distlearn/>

To prepare for a successful online learning experience, see helpful short videos at <http://www.mtsac.edu/distancelearning/quiz/>

41176	F	7:00pm - 10:10pm	Hoekstra, T	79-3250
		and arrange 7.75 hours	Hoekstra, T	ONLINE

8 Weeks, Week beginning 04/23/2018 ending 06/17/2018

NOTE: CRN 41176 is a Hybrid Class taught partially online with scheduled meetings on campus.

How to Begin Course: Log into Canvas through <http://myportal.mtsac.edu> and click on CRN for your DL course. If cannot locate your DL course in Canvas, contact the professor. On the first day of classes, log into your DL course to show your "attendance" because not doing so could result in your being dropped from the class for non-attendance.

Professor contact info: Email Professor Hoekstra at either: THoekstra@mtsac.edu, through Student Detail Schedule or Canvas at MyMtSAC Portal.

Students must use their Mt. SAC e-mail account and be aware of course commitment and student expectations described at <http://www.mtsac.edu/instruction/learning/distlearn/>

To prepare for a successful online learning experience, see helpful short videos at <http://www.mtsac.edu/distancelearning/quiz/>

■ **BUSA 11 — Fundamentals of Accounting** **3.0 Units**
Degree Applicable

Prerequisite: BUSA 68 or eligibility for MATH 50

Accounting vocabulary and theory, equations to solve word problems and other calculations used in accounting problems.

41130	Th	9:45am - 11:10am	Mc Geough, D	79-2270
		and arrange 1.7 hours	Mc Geough, D	ONLINE

NOTE: CRN 41130 is a Hybrid Class taught partially online with scheduled meetings on campus.

How to Begin Course: Log into Canvas through <http://myportal.mtsac.edu> and click on CRN for your DL course. If cannot locate your DL course in Canvas, contact the professor. On the first day of classes, log into your DL course to show your "attendance" because not doing so could result in your being dropped from the class for non-attendance.

Professor contact info: Email Professor McGeough at either: DMcGeough@mtsac.edu, through Student Detail Schedule or Canvas at MyMtSAC Portal.

Students must use their Mt. SAC e-mail account and be aware of course commitment and student expectations described at <http://www.mtsac.edu/instruction/learning/distlearn/>

To prepare for a successful online learning experience, see helpful short videos at <http://www.mtsac.edu/distancelearning/quiz/>

40885	M	7:00pm - 10:10pm	Freeland, E	78-3100
41146		arrange 3.4 hours	Mc Geough, D	ONLINE

NOTE: CRN 41146 is a Distance Learning Online Class.

How to Begin Course: Log into Canvas through <http://myportal.mtsac.edu> and click on CRN for your DL course. **NOTE:** Some courses may not be activated until the start of the term. If you cannot locate your DL course in Canvas when the term starts, contact the professor. **On the first day of classes, log into your DL course to show your "attendance" because not doing so could result in your being dropped from the class for non-attendance.**

Professor contact info: Email Professor McGeough at either: DMcGeough@mtsac.edu, through Student Detail Schedule or Canvas at MyMtSAC Portal.

Students must use their Mt. SAC e-mail account and be aware of course commitment and student expectations described at <http://www.mtsac.edu/instruction/learning/distlearn/>

To prepare for a successful online learning experience, see helpful short videos at <http://www.mtsac.edu/distancelearning/quiz/>

■ **BUSA 52 — Intermediate Accounting** **3.0 Units**
Degree Applicable

Prerequisite: BUSA 8

Accounting concepts and principles and an in-depth analysis of the balance sheet and income statement.

40886	T	7:00pm - 10:10pm	Bates, B	79-3230
-------	---	------------------	----------	---------

■ **BUSA 58 — Federal Income Tax Law** **3.0 Units**
Degree Applicable

Prerequisite: BUSA 7 or BUSA 72

Federal income tax law as related to individuals, with comparison to partnerships, corporations, and state.

40887	M	7:00pm - 10:10pm	Valdes, S	79-3230
-------	---	------------------	-----------	---------

■ **BUSA 68 — Business Mathematics** **3.0 Units**
Not Degree Applicable

Addition, subtraction, multiplication, division, decimals, percentages, fractions, equations, and problem solving.

40888 W 7:00pm - 10:10pm Freeland, E 78-3100
41153 arrange 3.4 hours Mc Geough, D ONLINE

NOTE: CRN 41153 is a Distance Learning Online Class.

How to Begin Course: Log into Canvas through <http://myportal.mtsac.edu> and click on CRN for your DL course. **NOTE:** Some courses may not be activated until the start of the term. If you cannot locate your DL course in Canvas when the term starts, contact the professor. **On the first day of classes, log into your DL course to show your "attendance" because not doing so could result in your being dropped from the class for non-attendance.**

Professor contact info: Email Professor McGeough at either: DMcGeough@mtsac.edu, through Student Detail Schedule or Canvas at MyMtSAC Portal.

Students must use their Mt. SAC e-mail account and be aware of course commitment and student expectations described at <http://www.mtsac.edu/instruction/learning/distlearn/>

To prepare for a successful online learning experience, see helpful short videos at <http://www.mtsac.edu/distancelearning/quiz/>

■ **BUSA 70 — Payroll and Tax Accounting** **3.0 Units**
Degree Applicable

Prerequisite: Eligibility for BUSA 11

On-the-job payroll accounting.

40889 W 7:00pm - 10:10pm Holloway, B 79-3230

■ **BUSA 71 — Personal Financial Planning** **3.0 Units**
Degree Applicable, CSU

Personal finance focusing on practical financial decision making. May not earn credit for both BUSA 71 and FCS 80.

41131 T 7:00pm - 10:10pm Smith, G 79-3240

■ **BUSA 72 — Bookkeeping - Accounting** **5.0 Units**
Degree Applicable

Prerequisite: BUSA 68 or eligibility for MATH 50

Bookkeeping and accounting principles including the accounting cycle.

40891 MW 7:00pm - 9:35pm St John, T 78-1130
41154 arrange 5.65 hours Domico, B ONLINE

NOTE: CRN 41154 is a Distance Learning Online Class.

How to Begin Course: Log into Canvas through <http://myportal.mtsac.edu> and click on CRN for your DL course. **NOTE:** Some courses may not be activated until the start of the term. If you cannot locate your DL course in Canvas when the term starts, contact the professor. **On the first day of classes, log into your DL course to show your "attendance" because not doing so could result in your being dropped from the class for non-attendance.**

Professor contact info: Email Professor Domico at either: BDomico@mtsac.edu, through Student Detail Schedule or Canvas at MyMtSAC Portal.

Students must use their Mt. SAC e-mail account and be aware of course commitment and student expectations described at <http://www.mtsac.edu/instruction/learning/distlearn/>

To prepare for a successful online learning experience, see helpful short videos at <http://www.mtsac.edu/distancelearning/quiz/>

■ **BUSA 75 — Using Microcomputers in Financial Accounting** **1.0 Unit**
Degree Applicable

Prerequisite: BUSA 7 or BUSA 72

Accounting concepts utilizing QuickBooks, a general-ledger software program. Computer processing of accounting transactions.

41155 M 4:30pm - 6:35pm Valdes, S 79-3270
8 Weeks, Week beginning 02/26/2018 ending 04/22/2018

NOTE: QuickBooks Accounting used for this course.

40892 Th 5:30pm - 7:35pm Quintero, H 79-3270
8 Weeks, Week beginning 02/26/2018 ending 04/22/2018

NOTE: QuickBooks Accounting used for this course.

■ **BUSA 76 — Using Microcomputers in Managerial Accounting** **1.0 Unit**
Degree Applicable

Prerequisite: BUSA 7 or BUSA 72

Analysis of financial data and preparation of managerial accounting reports using Excel software.

41156 M 9:45am - 11:50am Bates, B 79-3270

8 Weeks, Week beginning 02/26/2018 ending 04/22/2018

40893 Th 5:30pm - 7:35pm Quintero, H 79-3270

8 Weeks, Week beginning 04/23/2018 ending 06/17/2018

■ **BUSA 81 — Work Experience in Accounting** **1.0 Unit**
Degree Applicable

(May be taken for Pass/No Pass Only)

Prerequisite: Compliance with Work Experience regulations as designated in the College Catalog

Advisory: BUSA 7 or BUSA 72

Provides accounting students with on-the-job experience at an approved work site which is related to classroom-based learning.

41190 arrange 4.7 hours Domico, B OCAM

NOTE: CRN 41032 Provides the student with on-the-job experience in an approved work site. A minimum of 75 paid hours or 60 non-paid hours per term is required for each unit of credit. Work experience placement is not guaranteed. Student must contact Career Services Specialist, Dawn Finley at dfinley@mtsac.edu by January 22, 2018

■ **BUSA 81 — Work Experience in Accounting** **2.0 Units**
Degree Applicable

(May be taken for Pass/No Pass Only)

Prerequisite: Compliance with Work Experience regulations as designated in the College Catalog

Advisory: BUSA 7 or BUSA 72

Provides accounting students with on-the-job experience at an approved work site which is related to classroom-based learning.

41214 arrange 9.4 hours Domico, B OCAM

NOTE: CRN 41032 Provides the student with on-the-job experience in an approved work site. A minimum of 75 paid hours or 60 non-paid hours per term is required for each unit of credit. Work experience placement is not guaranteed. Student must contact Career Services Specialist, Dawn Finley at dfinley@mtsac.edu by January 22, 2018

BUSINESS: BUSINESS COMMUNICATIONS

■ **BUSO 25 — Business Communications** **3.0 Units**
(C-ID BUS 115)
Degree Applicable, CSU

Prerequisite: ENGL 1A

Apply writing principles to produce effective good news, bad news, sales, claims, persuasive, and job seeking correspondence.

40946 TTh 8:00am - 9:25am Bartz, V 77-2040

40945 M 7:00pm - 10:10pm Martinez, R 77-2040

40948 T 7:00pm - 10:10pm Blosser, K 77-2040

40947 Th 7:00pm - 10:10pm Salata, K 77-2040

■ **BUSO 26 — Oral Communications for Business** **3.0 Units**
Degree Applicable

(May be taken for option of Letter grade or Pass/NoPass)

Oral communication in business situations such as training sessions, presentations, and professional discussions.

40949 W 7:00pm - 10:10pm Dokter, D 77-2040

BUSINESS: ECONOMICS

■ BUSC 1A — Principles of Economics - Macroeconomics 3.0 Units
(C-ID ECON 202) Degree Applicable, CSU, UC

Prerequisite: Eligibility for ENGL 1A, and successful completion of MATH 71, or MATH 71B, or MATH 71X

Principles of aggregate economic analysis.

40894	MW	8:00am - 9:25am	Villasenor, S	78-3160
40895	TTh	8:00am - 9:25am	Dua, A	78-3160
40896	MW	9:45am - 11:10am	Villasenor, S	78-3160
40897	TTh	9:45am - 11:10am	Dua, A	78-3160
40898	MW	11:30am - 12:55pm	Chan, F	78-3160
40899	TTh	11:30am - 12:55pm	Dua, A	78-3160
40900	MW	1:15pm - 2:40pm	Villasenor, S	79-2270
40901	TTh	1:15pm - 2:40pm	Dua, A	78-3160
40902	MW	3:00pm - 4:25pm	Dua, A	78-3160
40903	TTh	3:00pm - 4:25pm	Baez, M	78-3160
40905	TTh	7:00pm - 10:10pm	Baez, M	78-3180

8 Weeks, Week beginning 02/26/2018 ending 04/22/2018

40904	W	7:00pm - 10:10pm	Zawahri, L	78-3160
41173	Th	7:00pm - 10:10pm	Zawahri, L	78-3160
41244		arrange 3.4 hours	Villasenor, S	ONLINE

NOTE:CRN 41244 is a Distance Learning Online class.

Course Orientation: On campus orientation (optional) meeting Monday, February 26 from 5:00 - 6:00 pm in 211-1. If a student cannot attend orientation meeting, student must contact professor before orientation meeting to avoid being dropped from class.

How to Begin Course: Log into Canvas through <http://myportal.mtsac.edu> and click on CRN for your DL course. **NOTE:** Some courses may not be activated until the start of the term. If you cannot locate your DL course in Canvas when the term starts, contact the professor. **On the first day of classes, log into your DL course to show your "attendance" because not doing so could result in your being dropped from the class for non-attendance.**

Professor contact info: Email Professor Villasenor at either: SVillase-nor7@mtsac.edu, through Student Detail Schedule or Canvas at MyMtSAC Portal.

Students must use their Mt. SAC e-mail account and be aware of course commitment and student expectations described at <http://www.mtsac.edu/instruction/learning/distlearn/>

To prepare for a successful online learning experience, see helpful short videos at <http://www.mtsac.edu/distancelearning/quiz/>

■ BUSC 1B — Principles of Economics - Microeconomics 3.0 Units
(C-ID ECON 201) Degree Applicable, CSU, UC

Prerequisite: BUSC 1A or BUSC 1AH

40906	TTh	8:00am - 9:25am	Villasenor, S	78-3180
40908	MW	9:45am - 11:10am	Chan, F	78-3180
41147	TTh	11:30am - 12:55pm	Abdel-Rahman, A	78-3180
41158	MW	1:15pm - 2:40pm	Dua, A	78-3160
40907	F	6:30pm - 9:40pm	Abdel-Rahman, A	78-3160
41159	M	7:00pm - 10:10pm	Chan, F	79-2230
41161	TTh	7:00pm - 10:10pm	Baez, M	78-3180

8 Weeks, Week beginning 04/23/2018 ending 06/17/2018

41160	W	7:00pm - 10:10pm	Ahmed, E	78-2195
-------	---	------------------	----------	---------

■ BUSC 1BH — Principles of Economics - Microeconomics - Honors 3.0 Units
(C-ID ECON 201) Degree Applicable, CSU, UC

Prerequisite: BUSC 1A or BUSC 1AH

44348	TTh	9:45am - 11:10am	Villasenor, S	78-3180
-------	-----	------------------	---------------	---------

■ BUSC 17 — Applied Business Statistics 3.0 Units
Degree Applicable, CSU, UC

Prerequisite: MATH 71

40910	MW	8:00am - 9:25am	Chan, F	79-2270
-------	----	-----------------	---------	---------

BUSINESS: LAW

■ BUSL 18 — Business Law 3.0 Units
(C-ID BUS 125) Degree Applicable, CSU, UC

Prerequisite: Eligibility for ENGL 68

Business law: court procedures, ethics, torts, crimes, contract law, and sales of goods under the Uniform Commercial Code.

40950	MW	8:00am - 9:25am	Mc Kee, C	78-3120
40955	F	8:00am - 11:10am	Uriarte, R	78-3120
40951	MW	9:45am - 11:10am	Wood, A	78-3120
40952	TTh	9:45am - 11:10am	Ashbran, R	78-3120
40953	MW	11:30am - 12:55pm	Wood, A	78-3180
40954	TTh	11:30am - 12:55pm	Mc Kee, C	78-3120
41208	MW	5:15pm - 6:40pm	Sweetman, S	78-3120
41129		arrange 3.4 hours	Mc Kee, C	ONLINE

NOTE:CRN 41129 is a Distance Learning Online Class.

Course Orientation: On campus orientation (optional) Monday, February 26 from 5:45-6:45 PM in 18-17. If a student cannot attend orientation meeting, student must contact professor before orientation meeting to avoid being dropped from class.

How to Begin Course: Log into Canvas through the eLearning Tools tab in the Mt. SAC portal at my.mtsac.edu. Then click on the Canvas link and then click on CRN for your DL course. **NOTE:** Some courses may not be activated until the start of the term. If you cannot locate your DL course in Canvas when the term starts, contact the professor. **On the first day of classes, log into your DL course to show your "attendance" because not doing so could result in your being dropped from the class for non-attendance.**

Professor contact info: Email Professor McKee at either: CMcKee@mtsac.edu, through Student Detail Schedule or Canvas at MyMtSAC Portal.

Students must use their Mt. SAC e-mail account and be aware of course commitment and student expectations described at <http://www.mtsac.edu/instruction/learning/distlearn/>

To prepare for a successful online learning experience, see helpful short videos at <http://www.mtsac.edu/distancelearning/quiz/>

41133		arrange 3.4 hours	Mc Kee, C	ONLINE
-------	--	-------------------	-----------	--------

NOTE:CRN 41133 is a Distance Learning Online Class.

Course Orientation: On campus orientation (optional) Monday, February 26 from 5:45-6:45 PM in 18-17. If a student cannot attend orientation meeting, student must contact professor before orientation meeting to avoid being dropped from class.

How to Begin Course: Log into Canvas through the eLearning Tools tab in the Mt. SAC portal at my.mtsac.edu. Then click on the Canvas link and then click on CRN for your DL course. **NOTE:** Some courses may not be activated until the start of the term. If you cannot locate your DL course in Canvas when the term starts, contact the professor. **On the first day of classes, log into your DL course to show your "attendance" because not doing so could result in your being dropped from the class for non-attendance.**

Professor contact info: Email Professor McKee at either: CMcKee@mtsac.edu, through Student Detail Schedule or Canvas at MyMtSAC Portal.

Students must use their Mt. SAC e-mail account and be aware of course commitment and student expectations described at <http://www.mtsac.edu/instruction/learning/distlearn/>

To prepare for a successful online learning experience, see helpful short videos at <http://www.mtsac.edu/distancelearning/quiz/>

41226 arrange 6.8 hours Mc Kee, C ONLINE

8 Weeks, Week beginning 02/26/2018 ending 04/22/2018**NOTE:** CRN 41226 is a Distance Learning Online Class.**Course Orientation:** On campus orientation (optional) Monday, February 26 from 5:45-6:45 PM in 18-17. If a student cannot attend orientation meeting, student must contact professor before orientation meeting to avoid being dropped from class.**How to Begin Course:** Log into Canvas through the eLearning Tools tab in the Mt. SAC portal at my.mtsac.edu. Then click on the Canvas link and then click on CRN for your DL course. **NOTE:** Some courses may not be activated until the start of the term. If you cannot locate your DL course in Canvas when the term starts, contact the professor. **On the first day of classes, log into your DL course to show your "attendance" because not doing so could result in your being dropped from the class for non-attendance.****Professor contact info:** Email Professor McKee at either: CMcKee@mtsac.edu, through Student Detail Schedule or Canvas at MyMtSAC Portal.**Students must use their Mt. SAC e-mail account and be aware of course commitment and student expectations described at <http://www.mtsac.edu/instruction/learning/distlearn/>**To prepare for a successful online learning experience, see helpful short videos at <http://www.mtsac.edu/distancelearning/quiz/>**■ BUSL 19 — Advanced Business Law 3.0 Units**
Degree Applicable, CSU, UC*Advisory: BUSL 18*

Principles of business law emphasizing commercial paper, agency, business entities, bankruptcy, trade, and real property.

40956 MW 8:00am - 9:25am Wood, A 78-3180

41193 arrange 3.4 hours Wood, A ONLINE

NOTE: CRN 41193 is a Distance Learning Online Class.**Course Orientation:** There is no on campus orientation for this course. You must log in to Canvas and complete the Syllabus Quiz to show your "attendance" on the first day.**How to Begin Course:** Log into Canvas through <http://myportal.mtsac.edu> and click on CRN for your DL course. **NOTE:** Some courses may not be activated until the start of the term. If you cannot locate your DL course in Canvas when the term starts, contact the professor. **On the first day of classes, log into your DL course to show your "attendance" because not doing so could result in your being dropped from the class for non-attendance.** **NOTE:** Check your campus email account for an email from Professor Wood by the first day of class.**Professor contact info:** Email Professor Wood at either: AWood10@mtsac.edu, through Student Detail Schedule or Canvas at MyMtSAC Portal.**Students must use their Mt. SAC e-mail account and be aware of course commitment and student expectations described at <http://www.mtsac.edu/instruction/learning/distlearn/>**To prepare for a successful online learning experience, see helpful short videos at <http://www.mtsac.edu/distancelearning/quiz/>

41216 arrange 6.8 hours Wood, A ONLINE

8 Weeks, Week beginning 04/23/2018 ending 06/17/2018**NOTE:** CRN 41216 is a Distance Learning Online Class.**Course Orientation:** There is no on campus orientation for this course. You must log in to Canvas and complete the Syllabus Quiz to show your "attendance" on the first day.**How to Begin Course:** Log into Canvas through <http://myportal.mtsac.edu> and click on CRN for your DL course. **NOTE:** Some courses may not be activated until the start of the term. If you cannot locate your DL course in Canvas when the term starts, contact the professor. **On the first day of classes, log into your DL course to show your "attendance" because not doing so could result in your being dropped from the class for non-attendance.** **NOTE:** Check your campus email account for an email from Professor Wood by the first day of class.**Professor contact info:** Email Professor Wood at either: AWood10@mtsac.edu, through Student Detail Schedule or Canvas at MyMtSAC Portal.**Students must use their Mt. SAC e-mail account and be aware of course commitment and student expectations described at <http://www.mtsac.edu/instruction/learning/distlearn/>**To prepare for a successful online learning experience, see helpful short videos at <http://www.mtsac.edu/distancelearning/quiz/>**BUSINESS: MANAGEMENT****■ BUSM 10 — Principles of Continuous Quality Improvement 3.0 Units**
Degree Applicable*Advisory: BUSO 5 or eligibility for ENGL 68*

History and evolution of thought in Continuous Quality Improvement.

40925 MW 11:30am - 12:55pm Freeman, C 79-3280

40926 M 7:00pm - 10:10pm Freeman, C 79-3280

■ BUSM 20 — Principles of Business 3.0 Units
Degree Applicable, CSU, UC*Prerequisite: Eligibility for ENGL 68*

Business and its functions, background, development, organization, current trends, future problems and opportunities.

40929 MW 8:00am - 9:25am Silva, J 79-3280

40927 MW 9:45am - 11:10am Freeman, C 79-3280

40930 TTh 9:45am - 11:10am Bartz, V 79-3290

40933 W 9:45am - 11:10am Mc Farland, T 79-3260
and arrange 1.7 hours Mc Farland, T ONLINE**NOTE:** CRN 40933 is a Distance Learning Hybrid class taught partially online with scheduled meetings on campus.**How to Begin Course:** Log into Canvas through <http://myportal.mtsac.edu> and click on CRN for your DL course. **NOTE:** Some courses may not be activated until the start of the term. If you cannot locate your DL course in Canvas when the term starts, contact the professor. **On the first day of classes, log into your DL course to show your "attendance" because not doing so could result in your being dropped from the class for non-attendance.****Professor contact info:** Email Professor McFarland at either: TMcFarland@mtsac.edu, through Student Detail Schedule or Canvas at MyMtSAC Portal.**Students must use their Mt. SAC e-mail account and be aware of course commitment and student expectations described at <http://www.mtsac.edu/instruction/learning/distlearn/>**To prepare for a successful online learning experience, see helpful short videos at <http://www.mtsac.edu/distancelearning/quiz/>

40931 MW 11:30am - 12:55pm Martinez, R 79-3290

40928 TTh 11:30am - 12:55pm Mc Farland, T 79-3260

41222 M 7:00pm - 10:10pm Atherton, S 79-3260

40932 T 7:00pm - 10:10pm Martinez, R 79-3290

41223 W 7:00pm - 10:10pm Carrasco, G 79-3260

40934 Th 7:00pm - 10:10pm Martinez, R 79-3290

41157 arrange 3.4 hours Mc Farland, T ONLINE
NOTE: CRN 41157 is a Distance Learning Online Class.**How to Begin Course:** Log into Canvas through <http://myportal.mtsac.edu> and click on CRN for your DL course. **NOTE:** Some courses may not be activated until the start of the term. If you cannot locate your DL course in Canvas when the term starts, contact the professor. **On the first day of classes, log into your DL course to show your "attendance" because not doing so could result in your being dropped from the class for non-attendance.****Professor contact info:** Email Professor McFarland at either: TMcFarland@mtsac.edu, through Student Detail Schedule or Canvas at MyMtSAC Portal.**Students must use their Mt. SAC e-mail account and be aware of course commitment and student expectations described at <http://www.mtsac.edu/instruction/learning/distlearn/>**To prepare for a successful online learning experience, see helpful short videos at <http://www.mtsac.edu/distancelearning/quiz/>

■ **BUSM 51 — Principles of International Business** **3.0 Units**
Degree Applicable, CSU

Advisory: Eligibility for ENGL 68 or BUSO 5

International business environment. Introduces global viewpoints across business functions.

40935	MW	9:45am - 11:10am	Jagodka, R	79-3240
40936		arrange	3.4 hours Jagodka, R	ONLINE

NOTE: CRN 409364 is a Distance Learning Online Class.

How to Begin Course: Log into Canvas through <http://myportal.mtsac.edu> and click on CRN for your DL course. If you cannot locate your DL course in Canvas, contact the professor. **On the first day of classes, log into your DL course to show your "attendance" because not doing so could result in your being dropped from the class for non-attendance.**

Professor contact info: Email Professor Jagodka at either: RJagodka@mtsac.edu, through Student Detail Schedule or Canvas at MyMtSAC Portal.

Students must use their Mt. SAC e-mail account and be aware of course commitment and student expectations described at <http://www.mtsac.edu/instruction/learning/distlearn/>

To prepare for a successful online learning experience, see helpful short videos at <http://www.mtsac.edu/distancelearning/quiz/>

■ **BUSM 60 — Human Relations in Business** **3.0 Units**
Degree Applicable, CSU

Inter-disciplinary study of how people work and relate at the individual, group and organizational level.

40938	TTh	8:00am - 9:25am	Simmons, S	79-3260
40937	TTh	9:45am - 11:10am	Mc Farland, T	79-3260
40939	T	7:00pm - 10:10pm	Dokter, D	79-3280

■ **BUSM 61 — Business Organization and Management** **3.0 Units**
Degree Applicable, CSU

Advisory: BUSM 20

Functions of management, management concepts, planning, organizing, staffing and controlling.

40940	MW	1:15pm - 2:40pm	Atherton, S	79-3260
41182	W	7:00pm - 10:10pm	Atherton, S	79-3240
41183		arrange	3.4 hours Mc Farland, T	ONLINE

NOTE: CRN 41183 is a Distance Learning Online Class.

How to Begin Course: Log into Canvas through <http://myportal.mtsac.edu> and click on CRN for your DL course. **NOTE:** Some courses may not be activated until the start of the term. If you cannot locate your DL course in Canvas when the term starts, contact the professor. **On the first day of classes, log into your DL course to show your "attendance" because not doing so could result in your being dropped from the class for non-attendance.**

Professor contact info: Email Professor McFarland at either: TMcFarland@mtsac.edu, through Student Detail Schedule or Canvas at MyMtSAC Portal.

Students must use their Mt. SAC e-mail account and be aware of course commitment and student expectations described at <http://www.mtsac.edu/instruction/learning/distlearn/>

To prepare for a successful online learning experience, see helpful short videos at <http://www.mtsac.edu/distancelearning/quiz/>

■ **BUSM 62 — Human Resource Management** **3.0 Units**
Degree Applicable

Direction of people and other functions of human resources.

40941	TTh	11:30am - 12:55pm	Silva, J	79-3290
40942	W	7:00pm - 10:10pm	Martinez, R	79-3290

■ **BUSM 66 — Small Business Management** **3.0 Units**
Degree Applicable, CSU

Organizing, starting, and operating a small business enterprise.

40943	TTh	8:00am - 9:25am	Jagodka, R	79-3240
40944	TTh	9:45am - 11:10am	Jagodka, R	79-3240
41225	Th	7:00pm - 10:10pm	Qu, G	79-3240
41195		arrange	3.4 hours Jagodka, R	ONLINE

NOTE: CRN 41195 is a Distance Learning Online Class.

How to Begin Course: Log into Canvas through <http://myportal.mtsac.edu> and click on CRN for your DL course. If you cannot locate your DL course in Canvas, contact the professor. **On the first day of classes, log into your DL course to show your "attendance" because not doing so could result in your being dropped from the class for non-attendance.**

Professor contact info: Email Professor Jagodka at either: RJagodka@mtsac.edu, through Student Detail Schedule or Canvas at MyMtSAC Portal.

Students must use their Mt. SAC e-mail account and be aware of course commitment and student expectations described at <http://www.mtsac.edu/instruction/learning/distlearn/>

To prepare for a successful online learning experience, see helpful short videos at <http://www.mtsac.edu/distancelearning/quiz/>

44720		arrange	3.4 hours Jagodka, R	ONLINE
-------	--	---------	----------------------	--------

NOTE: CRN 44720 is a Distance Learning Online Class.

How to Begin Course: Log into Canvas through <http://myportal.mtsac.edu> and click on CRN for your DL course. If you cannot locate your DL course in Canvas, contact the professor. **On the first day of classes, log into your DL course to show your "attendance" because not doing so could result in your being dropped from the class for non-attendance.**

Professor contact info: Email Professor Jagodka at either: RJagodka@mtsac.edu, through Student Detail Schedule or Canvas at MyMtSAC Portal.

Students must use their Mt. SAC e-mail account and be aware of course commitment and student expectations described at <http://www.mtsac.edu/instruction/learning/distlearn/>

To prepare for a successful online learning experience, see helpful short videos at <http://www.mtsac.edu/distancelearning/quiz/>

■ **BUSM 81 — Work Experience in Business** **1.0 Unit**
Degree Applicable

(May be taken for Pass/No Pass Only)

Corequisite: BUSM 20 (may have been taken previously)

Provides business students with on-the-job experience at an approved work site which is related to classroom-based learning.

41181		arrange	4.7 hours Dokter, D	OCAM
-------	--	---------	---------------------	------

NOTE: CRN 41181 Provides the student with on-the-job experience in an approved work site. A minimum of 75 paid hours or 60 non-paid hours per term is required for each unit of credit. Work experience placement is not guaranteed. Student must contact Career Services Specialist, Dawn Finley at dfinley@mtsac.edu by January 22, 2018

■ **BUSM 81 — Work Experience in Business** **2.0 Units**
Degree Applicable

(May be taken for Pass/No Pass Only)

Corequisite: BUSM 20 (may have been taken previously)

Provides business students with on-the-job experience at an approved work site which is related to classroom-based learning.

41215		arrange	9.4 hours Dokter, D	OCAM
-------	--	---------	---------------------	------

NOTE: CRN 41215 Provides the student with on-the-job experience in an approved work site. A minimum of 75 paid hours or 60 non-paid hours per term is required for each unit of credit. Work experience placement is not guaranteed. Student must contact Career Services Specialist, Dawn Finley at dfinley@mtsac.edu by January 22, 2018

■ **BUSM 81 — Work Experience in Business** **3.0 Units**
Degree Applicable

(May be taken for Pass/No Pass Only)

Corequisite: BUSM 20 (may have been taken previously)

Provides business students with on-the-job experience at an approved work site which is related to classroom-based learning.

41218 arrange 18.75 hours Dokter, D OCAM

NOTE: CRN 41218 Provides the student with on-the-job experience in an approved work site. A minimum of 75 paid hours or 60 non-paid hours per term is required for each unit of credit. Work experience placement is not guaranteed. Student must contact Career Services Specialist, Dawn Finley at dfinley@mtsac.edu by January 22, 2018

■ **BUSM 85 — Special Issues in Business** **2.0 Units**
Degree Applicable

(May be taken for option of Letter grade or Pass/NoPass)

Provide business majors with a forum to develop techniques in an actual business situation.

44071 Th 4:00pm - 6:05pm Martinez, R 79-3290

BUSINESS: REAL ESTATE

■ **BUSR 50 — Real Estate Principles** **3.0 Units**
Degree Applicable, CSU

Real estate law. Required by the Bureau of Real Estate (RE) for all RE sales persons.

40911 T 9:45am - 12:55pm Estes, E 77-2070

40912 M 3:00pm - 6:10pm Ledoux, L 78-3180

40913 W 7:00pm - 10:10pm Estes, E 77-2070

41162 arrange 3.4 hours Estes, E ONLINE

NOTE: CRN 41162 is a Distance Learning Online Class.

Course Orientation: On-campus orientation (optional) Monday, February 26 from 5:30-6:30 pm in 77-2070.

How to Begin Course: Log into Canvas through <http://myportal.mtsac.edu> and click on CRN for your DL course. If you cannot locate your DL course in Canvas, contact the professor. **On the first day of classes, log into your DL course to show your "attendance" because not doing so could result in your being dropped from the class for non-attendance.**

Professor contact info: Email Professor Estes at either: EEstes@mtsac.edu, through Student Detail Schedule or Canvas at MyMtSAC Portal.

Students must use their Mt. SAC e-mail account and be aware of course commitment and student expectations described at <http://www.mtsac.edu/instruction/learning/distlearn/>

To prepare for a successful online learning experience, see helpful short videos at <http://www.mtsac.edu/distancelearning/quiz/>

■ **BUSR 51 — Legal Aspects of Real Estate** **3.0 Units**
Degree Applicable

Prerequisite: BUSR 50

Real estate contracts and legal issues. Can be used to meet additional requirements for the salesperson or broker license.

40914 M 7:00pm - 10:10pm Estes, E 77-2070

■ **BUSR 52 — Real Estate Practice** **3.0 Units**
Degree Applicable

Corequisite: BUSR 50 (May have been taken previously)

Procedures and practices in the real estate office. Must be completed prior to applying to take the Salesperson License Exam.

40915 Th 9:45am - 12:55pm Estes, E 77-2070

40916 T 7:00pm - 10:10pm Tassone, R 77-2070

■ **BUSR 53 — Real Estate Finance** **3.0 Units**
Degree Applicable

Prerequisite: BUSR 50

Course may be used to meet the additional education requirement of the salesperson or broker license.

40917 W 7:00pm - 10:10pm Zamel, M 78-3180

■ **BUSR 60 — Real Estate Investment Planning** **3.0 Units**
Degree Applicable

Prerequisite: BUSR 50

Investment strategies involving all forms of real estate.

40918 T 7:00pm - 10:10pm Stephan, R 79-2230

■ **BUSR 62 — Mortgage Loan Brokering and Lending** **3.0 Units**
Degree Applicable

Prerequisite: BUSR 50

Laws governing mortgage brokerage and lending. May be used as an elective for the salesperson or broker license.

44337 M 7:00pm - 10:10pm STAFF 77-2080

■ **BUSR 81 — Appraisal: Principles and Procedures** **3.5 Units**
Degree Applicable

Advisory: BUSR 50

Required by OREA for all appraisal licenses and by DRE for real estate broker license. 60 hours OREA credit.

40919 Th 6:00pm - 9:35pm Mansfield, W 77-2070

BUSINESS: SALES, MERCHANDISING, AND MARKETING

■ **BUSS 33 — Advertising and Promotion** **3.0 Units**
Degree Applicable, CSU

Characteristics and role of advertising and promotion in business.

40920 MW 9:45am - 11:10am Scholz, S 79-3290

40921 T 7:00pm - 10:10pm Ishihara, C 79-3260

■ **BUSS 36 — Principles of Marketing** **3.0 Units**
Degree Applicable, CSU

Prerequisite: Eligibility for ENGL 68

Organization and function of system of distributing goods and services.

40922 MW 11:30am - 12:55pm Scholz, S 79-3260

40923 TTh 11:30am - 12:55pm Bartz, V 79-3240

41196 W 7:00pm - 10:10pm Sandhu, S 79-3280

■ **BUSS 50 — Retail Store Management and Merchandising** **3.0 Units**
Degree Applicable, CSU

Principles and practices in managing and merchandising retail stores.

41197 M 7:00pm - 10:10pm Salata, K 79-3240

Looking for a Career in Real Estate?

The market has turned around and values are returning to pre-recession levels!

Enroll today in:

BUSR 50
Real Estate Principles

BUSR 52
Real Estate Practice



For more information please call

Edwin Estes
909-274-6428

■ BUSS 79 — Work Experience in Marketing Management 1.0 Unit
Degree Applicable

(May be taken for Pass/No Pass Only)

Prerequisite: BUSS 33 or BUSS 35 or BUSS 36 or BUSS 50 and compliance with Work Experience regulations as designated in the College Catalog

Job experience at an approved work site. 75 paid or 60 non-paid hours required for each unit of credit.

40924 arrange 4.7 hours Dokter, D OCAM

NOTE: CRN 40924 Provides the student with on-the-job experience in an approved work site. A minimum of 75 paid hours or 60 non-paid hours per term is required for each unit of credit. Work experience placement is not guaranteed. Student must contact Career Services Specialist, Dawn Finley at dfinley@mtsac.edu by January 22, 2018**■ BUSS 79 — Work Experience in Marketing Management 2.0 Units**
Degree Applicable

(May be taken for Pass/No Pass Only)

Prerequisite: BUSS 33 or BUSS 35 or BUSS 36 or BUSS 50 and compliance with Work Experience regulations as designated in the College Catalog

Job experience at an approved work site. 75 paid or 60 non-paid hours required for each unit of credit.

41268 arrange 9.38 hours Dokter, D OCAM

NOTE: CRN 41268 Provides the student with on-the-job experience in an approved work site. A minimum of 75 paid hours or 60 non-paid hours per term is required for each unit of credit. Work experience placement is not guaranteed. Student must contact Career Services Specialist, Dawn Finley at dfinley@mtsac.edu by January 22, 2018**CHEMISTRY****■ CHEM 9 — Chemistry of Everyday Life 3.0 Units**
Degree Applicable, CSU

Chemistry for non-majors. Emphasis on application of chemistry principles to medicine, health, environment, and everyday lives.

43584 M 11:30am - 2:40pm Beam, T 7-2123

43585 M 3:00pm - 6:10pm Beam, T 7-2123

■ CHEM 10 — Chemistry for Allied Health Majors 5.0 Units
Degree Applicable, CSU, UC*Prerequisite: Eligibility for MATH 71*

Inorganic chemistry for health majors. Completion does not give eligibility for CHEM 50.

41828 MW 7:30am - 9:35am Clements, T 7-1114

and W 11:30am - 2:40pm Clements, T 60-3601

41826 TTh 7:30am - 9:35am Luo, Y 7-1114

and T 11:30am - 2:40pm STAFF 60-3601

41827 TTh 7:30am - 9:35am Luo, Y 7-1114

and Th 11:30am - 2:40pm Luo, Y 60-3601

41824 M 8:00am - 11:10am Roueintan, M 60-3601

and MW 12:00pm - 2:05pm Roueintan, M 7-1114

41829 W 8:00am - 11:10am Lord, H 60-3617

4.6 hours Lord, H 21F-2

41832 MW 8:30am - 10:35am Nguyen, T 60-3601

and M 11:30am - 2:40pm Nguyen, T 7-1114

41825 MW 12:00pm - 2:05pm Roueintan, M 60-3601

and W 8:00am - 11:10am Roueintan, M 60-3601

41830 TTh 12:00pm - 2:05pm STAFF 7-1114

and T 3:00pm - 6:10pm STAFF 60-3601

41875 TTh 12:00pm - 2:05pm STAFF 7-1114

and F 8:00am - 11:10am STAFF 60-3601

41831 W 3:00pm - 6:10pm Muleta, G 60-3601

and F 9:00am - 1:15pm Truttmann, J 7-1114

41835 M 6:00pm - 10:15pm Park, A 7-1114

and W 6:30pm - 9:40pm Park, A 60-3601

41836 T 6:00pm - 10:15pm Muleta, G 7-1114

and Th 6:30pm - 9:40pm Muleta, G 60-3601

41833 M 6:30pm - 9:40pm STAFF 60-3601

and W 6:00pm - 10:15pm STAFF 7-1114

41834 T 6:30pm - 9:40pm Oda, M 60-3601

and Th 6:00pm - 10:15pm Oda, M 7-1114

■ CHEM 20 — Introductory Organic and Biochemistry 5.0 Units
Degree Applicable, CSU, UC*Prerequisite: CHEM 10 or CHEM 40*

Nomenclature, structure, function and reactions of organic compounds. Structure and function of biomolecules.

41837 WF 9:45am - 11:10am Craft, E 7-2123

and W 11:30am - 1:35pm Craft, E 7-2123

and F 11:30am - 3:45pm Craft, E 7-2123

41838 TTh 1:15pm - 2:40pm Nejad, I 7-1201

and T 3:00pm - 5:05pm Nejad, I 7-2123

and Th 3:00pm - 7:20pm Nejad, I 7-2123

■ CHEM 40 — Introduction to General Chemistry 5.0 Units
(C-ID CHEM 101) Degree Applicable, CSU, UC*Prerequisite: Eligibility for MATH 71**Advisory: Eligibility for ENGL 1A*

Chemistry for science and engineering majors. Completion prepares students to take CHEM 50.

41878 MW 7:30am - 9:35am Chen, J 7-1201

and F 8:00am - 11:10am Chen, J 60-3609

41879 MW 7:30am - 9:35am Mahjoor, P 21G-2

and F 11:30am - 2:40pm Mahjoor, P 60-3609

41839 M 8:00am - 11:10am Huang, K 60-3609

and MW 12:00pm - 2:05pm Huang, K 7-2114

41841 T 8:00am - 11:10am Cui, W 60-3609

and TTh 12:00pm - 2:05pm Chen, J 7-2114

41843 MW 8:30am - 10:35am Golestaneh, K 7-2114

and M 11:30am - 2:40pm Golestaneh, K 60-3609

41845 MW 8:30am - 10:35am Golestaneh, K 7-2114

and W 11:30am - 2:40pm Golestaneh, K 60-3609

41844 TTh 8:30am - 10:35am Leung, J 7-2114

and T 11:30am - 2:40pm Leung, J 60-3609

41847 MW 9:45am - 11:50am Nejad, I 7-1114

and M 3:00pm - 6:10pm Nejad, I 60-3609

41840 MW 12:00pm - 2:05pm Huang, K 7-2114

and W 8:00am - 11:10am Huang, K 60-3609

41842 TTh 12:00pm - 2:05pm Chen, J 7-2114

and Th 8:00am - 11:10am STAFF 60-3609

41848 T 3:00pm - 6:10pm STAFF 60-3609

and TTh 6:45pm - 8:50pm STAFF 7-1201

41850 Th 3:00pm - 6:10pm STAFF 60-3609

and F 8:00am - 12:15pm STAFF 7-2114

41846 TTh 3:15pm - 5:20pm STAFF 7-2114

and Th 11:30am - 2:40pm STAFF 60-3609

41849 MW 6:45pm - 8:50pm STAFF 61

and W 3:00pm - 6:10pm STAFF 60-3609

41876 M 6:00pm - 10:15pm Doshi, D 7-2114

and W 6:30pm - 9:40pm Doshi, D 60-3609

41877 T 6:00pm - 10:15pm Shah, S 7-2114

and Th 6:30pm - 9:40pm Shah, S 60-3609

41851 M 6:30pm - 9:40pm Parra, M 60-3609

and W 6:00pm - 10:15pm Parra, M 7-2114

41852 T 6:30pm - 9:40pm STAFF 60-3609

and Th 6:00pm - 10:15pm STAFF 7-2114

■ CHEM 50 — General Chemistry I **5.0 Units**
(C-ID CHEM 110) Degree Applicable, CSU, UC

Prerequisite: CHEM 40 or satisfactory score on Chemistry Placement Examination; and MATH 71, 71B, 71X or equivalent.

General Chemistry topics including, stoichiometry, reactions, bonding, thermochemistry, periodic trends and atomic structure.

41853	MW	8:00am - 11:10am	Colby, K	60-3620
and MW		11:30am - 12:55pm	Colby, K	7-2102
41861	MW	8:00am - 9:25am	Kung, A	7-2102
and F		8:00am - 2:35pm	Kung, A	60-3620
41880	MW	8:00am - 9:25am	Zaitoun, B	61
and F		8:00am - 2:35pm	Zaitoun, B	60-3617
41855	TTh	9:45am - 11:10am	Beam, T	7-2102
and TTh		11:30am - 2:40pm	Beam, T	60-3620
41881	MW	11:30am - 2:40pm	Efron, A	60-3617
and MW		3:00pm - 4:25pm	STAFF	7-2102
41856	TTh	11:30am - 2:40pm	STAFF	60-3617
and TTh		3:00pm - 4:25pm	STAFF	7-2102
41857	MW	1:15pm - 2:40pm	Hogenaue, T	7-2102
and MW		3:00pm - 6:10pm	Hogenaue, T	60-3620
41858	TTh	1:15pm - 2:40pm	Newman, C	7-2102
and TTh		3:00pm - 6:10pm	Newman, C	60-3620
41882	TTh	4:45pm - 6:10pm	Mayo, A	61
and TTh		7:00pm - 10:10pm	Mayo, A	60-3617
41859	MW	5:15pm - 6:40pm	Srulevitch, D	7-2102
and MW		7:00pm - 10:10pm	Srulevitch, D	60-3620
41860	TTh	5:15pm - 6:40pm	Mayo, D	7-2102
and TTh		7:00pm - 10:10pm	Mayo, D	60-3620

■ CHEM 50H — General Chemistry I - Honors **5.0 Units**
(C-ID CHEM 110) Degree Applicable, CSU, UC

Prerequisite: Acceptance into the Honors Program. CHEM 40 or satisfactory score on Chemistry Placement Examination, and MATH 71, 71B, or 71X or equivalent.

Stoichiometry, reactions, bonding, enthalpy, periodic trends, atomic structure. Honors course provides enriched experience.

44160	TTh	8:00am - 11:10am	Roueintan, M	60-3620
and TTh		11:30am - 12:55pm	Roueintan, M	7-2102
41862	MW	9:45am - 11:10am	Chen, J	7-2102
and MW		11:30am - 2:40pm	Chen, J	60-3620

■ CHEM 51 — General Chemistry II **5.0 Units**
Degree Applicable, CSU, UC

Prerequisite: CHEM 50 or CHEM 50H

Kinetics, equilibrium, thermodynamics, acid-base reactions, transition metals, electrochemistry, and nuclear chemistry.

41863	MW	8:00am - 11:10am	Van Wart, A	60-3628
and MW		11:30am - 12:55pm	Van Wart, A	7-1201
41864	TTh	8:00am - 11:10am	Clements, T	60-3628
and TTh		11:30am - 12:55pm	Clements, T	7-1201
41865	MW	9:45am - 11:10am	Mahjoor, P	7-1201
and MW		11:30am - 2:40pm	Mahjoor, P	60-3628
41866	TTh	9:45am - 11:10am	Golestaneh, K	7-1201
and TTh		11:30am - 2:40pm	Golestaneh, K	60-3628
41867	TTh	1:15pm - 2:40pm	Doshi, D	61-2316
and TTh		3:00pm - 6:10pm	Doshi, D	60-3628
41868	MW	5:15pm - 6:40pm	Edison, T	7-1201
and MW		7:00pm - 10:10pm	Edison, T	60-3628
41883	TTh	5:15pm - 6:40pm	STAFF	7-1201
and TTh		7:00pm - 10:10pm	STAFF	60-3628

■ CHEM 51H — General Chemistry II - Honors **5.0 Units**
Degree Applicable, CSU, UC

Prerequisite: Acceptance into the Honors Program and CHEM 50 or CHEM 50H

Kinetics, equilibrium, acid-base, thermodynamics, nuclear, electrochemistry. May not receive credit for both CHEM 51 and CHEM 51H.

43480	TTh	8:00am - 9:25am	Di Mauro, E	7-1201
and F		8:00am - 2:35pm	Di Mauro, E	60-3628

■ CHEM 80 — Organic Chemistry **5.0 Units**
(C-ID CHEM 160S) Degree Applicable, CSU, UC

Prerequisite: CHEM 51

Organic compounds' molecular structures, energetics, reactions, mechanisms, synthesis, separation, characterization, spectroscopy.

41869	MW	8:00am - 11:10am	Truttman, J	7-2111
and MW		11:30am - 12:55pm	Truttman, J	21H-2
41870	TTh	8:00am - 11:10am	Nguyen, T	7-2111
and TTh		3:00pm - 4:25pm	Nguyen, T	7-1201
41871	TTh	9:45am - 11:10am	Huang, K	7-2123
and TTh		11:30am - 2:40pm	Huang, K	7-2111
41872	MW	1:15pm - 2:40pm	Prutyantov, V	21H-1
and MW		3:00pm - 6:10pm	Prutyantov, V	7-2111
42000	TTh	5:15pm - 6:40pm	Watson, A	61-2302
and TTh		7:00pm - 10:10pm	Watson, A	7-2111

■ CHEM 81 — Organic Chemistry II **5.0 Units**
(C-ID CHEM 160S) Degree Applicable, CSU, UC

Prerequisite: CHEM 80

Focuses on spectroscopic methods for structure determination, reactions, mechanisms, and syntheses.

41873	MW	9:45am - 11:10am	Leung, J	7-1114
and MW		11:30am - 2:40pm	Leung, J	7-2111
41874	TTh	1:15pm - 2:40pm	Nguyen, J	21A-2
and TTh		3:00pm - 6:10pm	Nguyen, J	7-2111
41999	MW	5:15pm - 6:40pm	Bernard, S	61
and MW		7:00pm - 10:10pm	Bernard, S	7-2111

CHILD DEVELOPMENT

■ CHLD 1 — Child, Family, School and Community **3.0 Units**
(C-ID CDEV 110) Degree Applicable, CSU, UC

Prerequisite: Eligibility for ENGL 68

Home, child, school and community relationships in historical/contemporary perspectives regarding the socialization of children.

40972	MW	8:00am - 9:25am	Horwitz, E	73-1810
40973	TTh	8:00am - 9:25am	Henry, A	73-1840
40974	MW	9:45am - 11:10am	Henry, A	73-1810
40975	TTh	9:45am - 11:10am	Williamson, K	73-1820
40976	MW	11:30am - 12:55pm	Bazikyan, I	73-1810
41150	F	11:30am - 2:40pm	Jackson, L	73-1840
40977	MW	1:15pm - 2:40pm	Horwitz, E	73-1840
40978	W	3:00pm - 6:10pm	Landeros, D	73-1810
41210	T	6:30pm - 9:40pm	Williamson, K	73-1860

■ CHLD 5 — Principles and Practices in Child Development Programs **3.0 Units**

(C-ID ECE 120) Degree Applicable, CSU

Programs, appropriate practices, regulations, inclusive environments. 6 hrs observations. TB clearance required.

40979	TTh	9:45am - 11:10am	Bazikyan, I	73-1860
41138	M	3:00pm - 6:10pm	Williamson, K	73-1860

■ CHLD 6 — Introduction to Child Development Curriculum **3.0 Units**
(C-ID ECE 130) Degree Applicable, CSU

Advisory: CHLD 5 or CHLD 10 or CHLD 10H

Curriculum designs, content areas and environments appropriate for children birth-8 years old. TB test and observations required.

40981	TTh	11:30am - 2:40pm	Moore, R	73-1810
8 Weeks, Week beginning 02/26/2018 ending 04/22/2018				
40980	W	6:30pm - 9:40pm	Mejia Gonzalez, E	73-1810

■ CHLD 10 — Child Growth and Lifespan Development 3.0 Units

Degree Applicable, CSU, UC

Human lifespan and developmental influences. Out-of-class observations and interviews. TB test required.

40982	MW	8:00am - 9:25am	Fernandez, M	73-1820
44353	TTh	8:00am - 11:10am	Fernandez, M	73-1810
8 Weeks, Week beginning 04/23/2018 ending 06/17/2018				
40983	F	8:00am - 11:10am	Fernandez, M	73-1860
40984	MW	9:45am - 11:10am	Landeros, D	73-1820
40986	TTh	11:30am - 12:55pm	Toyoshima, H	73-1840
40987	MW	1:15pm - 2:40pm	Horwitz, E	73-1860
40990	Th	3:00pm - 6:10pm	Landeros, T	73-1820
41212	F	3:00pm - 6:10pm	Moore, R	73-1860
40989	T	6:30pm - 9:40pm	Anderson, L	73-1810
41179	W	6:30pm - 9:40pm	Anderson, L	73-1820
41209	Th	6:30pm - 9:40pm	Jackson, L	73-1840
44356	F	6:30pm - 9:40pm	Gethers, S	73-1860
41143		arrange 3.4 hours	Curran, K	ONLINE

NOTE: CRN 40318 is a Distance Learning Online class.**Other Course Requirements:** Students will do required observations on their own time.**How to Begin Course:** Log into Canvas through <http://myportal.mtsac.edu> and click on CRN for your DL course. **NOTE:** Some courses may not be activated until the start of the term. If you cannot locate your DL course in Canvas when the term starts, contact the professor.**On the first day of classes, log into your DL course to show your "attendance" because not doing so could result in your being dropped from the class for non-attendance.****Professor contact info:** Email Professor Curran at either: KCurran@mtsac.edu, through Student Detail Schedule or Canvas at MyMtSAC Portal.**Students must use their Mt. SAC e-mail account and be aware of course commitment and student expectations described at <http://www.mtsac.edu/instruction/learning/distlearn/>**To prepare for a successful online learning experience, see helpful short videos <http://www.mtsac.edu/distancelearning/quiz/>**■ CHLD 10H — Child Growth and Lifespan Development - Honors 3.0 Units**

Degree Applicable, CSU, UC

Prerequisite: Acceptance into the Honors Program

Human lifespan and developmental influences studied. Out-of-class observations and interviews required. TB test required.

40991	T	3:00pm - 6:10pm	Hughey, D	73-1820
-------	---	-----------------	-----------	---------

■ CHLD 11 — Child and Adolescent Development 3.0 Units

(C-ID CDEV 100) Degree Applicable, CSU, UC

Prenatal through adolescence developmental influences. TB test, out-of-class observations and interviews required. For CD major.

40992	MW	8:00am - 9:25am	Valadez, L	73-1860
41145	MW	9:45am - 11:10am	Bazikyan, I	73-1860
41180	TTh	9:45am - 11:10am	Henry, A	73-1840
44386	MW	11:30am - 12:55pm	Landeros, D	73-1860
40993	TTh	11:30am - 12:55pm	Bazikyan, I	73-1860
40994	TTh	1:15pm - 2:40pm	STAFF	73-1860
41139	T	3:00pm - 6:10pm	Landeros, D	73-1840
41149	T	6:30pm - 9:40pm	Cardenas, Y	73-1840

■ CHLD 50 — Teaching in a Diverse Society 3.0 Units

Degree Applicable, CSU

Advisory: CHLD 1

Social identities development, approaches to diversity, effective and respectful handling of bias with children and families. TB test.

40995	T	3:00pm - 6:10pm	Williamson, K	73-1810
-------	---	-----------------	---------------	---------

■ CHLD 51 — Early Literacy in Child Development 3.0 Units

Degree Applicable, CSU

Advisory: CHLD 61

Examines the evolution of early literacy, including cultural and linguistic diversity factors. TB test/observations required.

40996	TTh	1:15pm - 2:40pm	Hughey, D	73-1820
-------	-----	-----------------	-----------	---------

■ CHLD 61 — Language Arts and Art Media for Young Children 3.0 Units

Degree Applicable

Exploration of activities and techniques to develop artistic creativity and literacy skills in young children.

40997	W	3:00pm - 6:10pm	Williamson, K	73-1820
-------	---	-----------------	---------------	---------

■ CHLD 62 — Music and Motor Development for Young Children 3.0 Units

Degree Applicable, CSU

Role of music and movement in a young child's sensory motor development. TB test/observations required.

40998	Th	6:30pm - 9:40pm	Campbell, F	73-1810
-------	----	-----------------	-------------	---------

■ CHLD 63 — Creative Sciencing and Math for Young Children 3.0 Units

Degree Applicable, CSU

Advisory: Eligibility for ENGL 68

Exploration of children's thinking and problem-solving abilities. Includes planning and creating science and math experiences.

40999	M	3:00pm - 6:10pm	Henry, A	73-1820
-------	---	-----------------	----------	---------

■ CHLD 64 — Health, Safety and Nutrition of Children 3.0 Units

(C-ID ECE 220) Degree Applicable, CSU

Examines the relationship between a child's health status, safe learning environments, and proper nutrition.

41000	W	3:00pm - 6:10pm	Thay, C	73-1860
41001	Th	6:30pm - 9:40pm	Mateo, S	73-1820

■ CHLD 66 — Early Childhood Development Observation and Assessment 2.0 Units

(C-ID ECE 200) Degree Applicable, CSU

*Prerequisite: CHLD 5 and CHLD 11**Corequisite: CHLD 66L**Advisory: Eligibility for ENGL 68*

Observation and assessment to document children development. Need immunizations and TB clearance

41002	M	6:30pm - 8:35pm	Bazikyan, I	73-1820
-------	---	-----------------	-------------	---------

MT. SAC CHILD DEVELOPMENT COMPLEX



A NEW place where your child can thrive!

- Licensed for ages birth to preschool
- Meals and snacks
- Age-appropriate activities
- Quality care in a safe, stimulating environment
- Credentialed teachers/professional child development staff

Convenient hours:

Monday - Thursday: 7:00 a.m. - 6:00 p.m.

Friday: 7:00 a.m. - 5:00 p.m.



CDC is located on the corner of Bonita Drive and Walnut Drive in Buildings 70-73.
Call (909) 274-4920

■ CHLD 66L — Early Childhood Development Observation and Assessment Laboratory 1.0 Unit

(C-ID ECE 200) Degree Applicable, CSU

Prerequisite: CHLD 5 and CHLD 11

Corequisite: CHLD 66

Advisory: Eligibility for ENGL 68

Observation and assessment at the Early Childhood Education Lab School. Need enrollment in CHLD 66, immunizations, and TB clearance.

41009 M 9:00am - 12:10pm Jackson, L 72-1630

NOTE: CRN 40163 Students must provide documentation of influenza, pertussis (TDap) and measles immunization, as well as TB clearance, as required by SB792 prior to being permitted to enroll in this class. Instructions on submitting documentation are available at <http://mtsac.edu/cdc/immunization>

41003 T 9:00am - 12:05pm Campbell, F 72-1630

NOTE: CRN 40157 Students must provide documentation of influenza, pertussis (TDap) and measles immunization, as well as TB clearance, as required by SB792 prior to being permitted to enroll in this class. Instructions on submitting documentation are available at <http://mtsac.edu/cdc/immunization>

41004 W 9:00am - 12:10pm Campbell, F 72-1630

NOTE: CRN 40158 Students must provide documentation of influenza, pertussis (TDap) and measles immunization, as well as TB clearance, as required by SB792 prior to being permitted to enroll in this class. Instructions on submitting documentation are available at <http://mtsac.edu/cdc/immunization>

41005 Th 9:00am - 12:10pm Thay, C 72-1630

NOTE: CRN 40159 Students must provide documentation of influenza, pertussis (TDap) and measles immunization, as well as TB clearance, as required by SB792 prior to being permitted to enroll in this class. Instructions on submitting documentation are available at <http://mtsac.edu/cdc/immunization>

41006 M 3:00pm - 6:10pm Thay, C 72-1630

NOTE: CRN 40160 Students must provide documentation of influenza, pertussis (TDap) and measles immunization, as well as TB clearance, as required by SB792 prior to being permitted to enroll in this class. Instructions on submitting documentation are available at <http://mtsac.edu/cdc/immunization>

41007 T 3:00pm - 6:10pm Bazikyan, I 72-1630

NOTE: CRN 40161 Students must provide documentation of influenza, pertussis (TDap) and measles immunization, as well as TB clearance, as required by SB792 prior to being permitted to enroll in this class. Instructions on submitting documentation are available at <http://mtsac.edu/cdc/immunization>

41008 W 3:00pm - 6:10pm Bazikyan, I 72-1630

NOTE: CRN 40162 Students must provide documentation of influenza, pertussis (TDap) and measles immunization, as well as TB clearance, as required by SB792 prior to being permitted to enroll in this class. Instructions on submitting documentation are available at <http://mtsac.edu/cdc/immunization>

■ **CHLD 67 — Early Childhood Education Practicum** **2.0 Units**
Degree Applicable, CSU

Prerequisite: CHLD 1 and CHLD 6 and CHLD 66 and CHLD 66L

Corequisite: CHLD 67L

Advisory: CHLD 61, or CHLD 62, or CHLD 63

Child development principles preschool classroom settings and recognition of skills necessary for the teacher of young children.

41010 M 6:30pm - 8:35pm **Thay, C** 72-1630

■ **CHLD 67L — Early Childhood Education Practicum Laboratory** **1.0 Unit**
Degree Applicable, CSU

Corequisite: CHLD 67

Supervised teaching experience. Plan and implement curriculum for preschool children. Immunization and TB clearance required.

41017 M 8:30am - 12:05pm **Jackson, L** 72-1630

NOTE: CRN 40171 Students must provide documentation of influenza, pertussis (TDap) and measles immunization, as well as TB clearance, as required by SB792 prior to being permitted to enroll in this class. Instructions on submitting documentation are available at <http://mtsac.edu/cdc/immunization>

41011 T 8:30am - 12:05pm **Campbell, F** 72-1630

NOTE: CRN 40165 Students must provide documentation of influenza, pertussis (TDap) and measles immunization, as well as TB clearance, as required by SB792 prior to being permitted to enroll in this class. Instructions on submitting documentation are available at <http://mtsac.edu/cdc/immunization>

41012 W 8:30am - 12:05pm **Campbell, F** 72-1630

NOTE: CRN 40166 Students must provide documentation of influenza, pertussis (TDap) and measles immunization, as well as TB clearance, as required by SB792 prior to being permitted to enroll in this class. Instructions on submitting documentation are available at <http://mtsac.edu/cdc/immunization>

41013 Th 8:30am - 12:05pm **Thay, C** 72-1630

NOTE: CRN 40167 Students must provide documentation of influenza, pertussis (TDap) and measles immunization, as well as TB clearance, as required by SB792 prior to being permitted to enroll in this class. Instructions on submitting documentation are available at <http://mtsac.edu/cdc/immunization>

41014 M 2:30pm - 6:05pm **Thay, C** 72-1630

NOTE: CRN 40168 Students must provide documentation of influenza, pertussis (TDap) and measles immunization, as well as TB clearance, as required by SB792 prior to being permitted to enroll in this class. Instructions on submitting documentation are available at <http://mtsac.edu/cdc/immunization>

41015 T 2:30pm - 6:05pm **Bazikyan, I** 72-1630

NOTE: CRN 40169 Students must provide documentation of influenza, pertussis (TDap) and measles immunization, as well as TB clearance, as required by SB792 prior to being permitted to enroll in this class. Instructions on submitting documentation are available at <http://mtsac.edu/cdc/immunization>

41016 W 2:30pm - 6:05pm **Bazikyan, I** 72-1630

NOTE: CRN 40170 Students must provide documentation of influenza, pertussis (TDap) and measles immunization, as well as TB clearance, as required by SB792 prior to being permitted to enroll in this class. Instructions on submitting documentation are available at <http://mtsac.edu/cdc/immunization>

■ **CHLD 68 — Children With Special Needs** **3.0 Units**
Degree Applicable, CSU

Prerequisite: Eligibility for ENGL 68 AND (CHLD 10 or CHLD 10H or CHLD 11)

Teaching children with special needs. TB test required for off-campus observations.

41018 W 3:00pm - 6:10pm **Hughey, D** 73-1840

41019 Th 3:00pm - 6:10pm **Hughey, D** 73-1840

■ **CHLD 69 — Early Childhood Development Field Work Seminar** **2.0 Units**
Degree Applicable, CSU

Prerequisite: (CHLD 67 and CHLD 67L) or (CHLD 86 and CHLD 87)

Corequisite: CHLD 91

Selected problem-solving topics related to student teaching at community sites.

41020 M 6:30pm - 8:35pm **Henry, A** 70-1213

■ **CHLD 71B — Management/Marketing/Personnel for ECD Programs** **3.0 Units**
Degree Applicable, CSU

Prerequisite: CHLD 71A

Strategic planning for childhood programs, including financial administration, marketing strategies and staff development.

44357 W 6:30pm - 9:40pm **Addison, T** 73-1840

■ **CHLD 72 — Teacher, Parent, and Child Relationships** **3.0 Units**
Degree Applicable

Child-parent-teacher relationships to understand family dynamics and influences in the child development setting.

41134 TTh 11:30am - 12:55pm **Landeros, D** 73-1820

■ **CHLD 73 — Infant and Toddler Development** **3.0 Units**
Degree Applicable, CSU

Advisory: CHLD 11 and Eligibility for ENGL 68

Infant and toddler development from pre-conception to age 3. Observations required. Tuberculosis (TB) clearance required.

41021 MW 9:45am - 11:10am **Thay, C** 73-1840

41141 M 6:30pm - 9:40pm **Bailey, Y** 73-1810

■ **CHLD 75 — Supervising Adults in Early Childhood Settings** **2.0 Units**
Degree Applicable, CSU

Advisory: CHLD 1 and CHLD 5

Methods and principles of working with and supervising adults in the early childhood setting.

41022 W 6:30pm - 9:50pm **Medrano, M** 73-1860
10 Weeks, Week beginning 04/09/2018 ending 06/17/2018

■ **CHLD 84 — Guidance and Discipline in Child Development Settings** **1.0 Unit**
Degree Applicable, CSU

Advisory: CHLD 5

Problem solving approach to guidance and discipline of children in child development settings.

41023 W 6:30pm - 9:40pm **Hernandez, G** 73-1860
6 Weeks, Week beginning 02/26/2018 ending 04/08/2018

■ **CHLD 85 — Infants At Risk** **3.0 Units**
Degree Applicable

Prerequisite: CHLD 10 or CHLD 10H or CHLD 11

Advisory: CHLD 73

Early intervention for disabled or at-risk infants. TB test and out-of-class observations required.

41024 MW 11:30am - 12:55pm **Thay, C** 73-1840

■ **CHLD 86 — Infant Toddler Practicum Seminar** **2.0 Units**
Not Degree Applicable, CSU

Prerequisite: CHLD 66 AND CHLD 66L AND CHLD 73 AND CHLD 79

Corequisite: CHLD 87

Child development principles needed to plan, prepare, and implement curriculum for infant and toddler classroom settings.

44359 T 6:30pm - 8:35pm **Thay, C** 73-1820

■ CHLD 87 — Infant Toddler Practicum Field Work Experience **1.0 Unit**

Not Degree Applicable

(May be taken for Pass/No Pass Only)

Prerequisite: CHLD 66 AND CHLD 66L AND CHLD 73 AND CHLD 79

Corequisite: CHLD 86

Supervised work experience infants and toddlers. 75 paid or 60 non-paid hours per unit. Immunization and TB clearance required.

44364	arrange	3.75 hours	Thay, C		OCAM
-------	---------	------------	---------	--	------

■ CHLD 91 — Early Childhood Development Field Work **1.0 Unit**

Degree Applicable, CSU

(May be taken for Pass/No Pass Only)

Prerequisite: (CHLD 67 and CHLD 67L) or (CHLD 86 and CHLD 87)

Corequisite: CHLD 69

Supervised student teaching experience. Minimum 60 non-paid or 75 paid hours for one unit. Immunization and TB clearance required.

41025	arrange	4.7 hours	Henry, A		OCAM
-------	---------	-----------	----------	--	------

NOTE: CRN 41025 Students must provide documentation of influenza, pertussis (TDap) and measles immunization, as well as TB clearance, as required by SB792 prior to being permitted to enroll in this class. Instructions on submitting documentation are available at <http://mitsac.edu/cdc/immunization>

CHINESE

■ CHIN 1 — Elementary Chinese **4.0 Units**

Degree Applicable, CSU, UC

Beginning course for students without previous exposure to Mandarin Chinese.

44074	F	9:00am - 1:20pm	Chang, C		66-269
42913	MW	9:45am - 11:50am	Liu, M		17-13
42916	TTh	9:45am - 11:50am	Chang, C		66-269
42914	MW	12:00pm - 2:05pm	Wu, D		18-1
42915	MW	2:15pm - 4:20pm	Dong, M		66-269
43004	TTh	6:45pm - 8:50pm	Chen, R		66-269

■ CHIN 2 — Continuing Elementary Chinese **4.0 Units**

Degree Applicable, CSU, UC

Prerequisite: CHIN 1 or equivalent

Further development of elementary skills in Mandarin Chinese with an emphasis on Chinese culture.

42917	MW	9:45am - 11:50am	Chang, C		66-269
42918	TTh	12:00pm - 2:05pm	Chang, C		66-269

■ CHIN 3 — Intermediate Chinese **4.0 Units**

Degree Applicable, CSU, UC

Prerequisite: CHIN 2

Further development of Mandarin Chinese language skills and their use as tools in exploring Chinese civilization.

42920	MW	12:00pm - 2:05pm	Chang, C		66-269
-------	----	------------------	----------	--	--------

COMPUTER INFORMATION SYSTEMS: BEGINNING

■ CISB 10 — Office Skills **3.0 Units**

Degree Applicable

Skills necessary to work in an office setting: keyboarding, email, calendaring and composing documents.

41199	F	9:00am - 12:10pm	Sokol, A		78-2140
41198	M	7:00pm - 10:10pm	Zelaya, G		79-2280
41241	W	7:00pm - 10:10pm	Syiem, J		79-2260

■ CISB 11 — Computer Information Systems **3.5 Units**

(C-ID BUS 140)(C-ID ITIS 120) Degree Applicable, CSU, UC

Overview of computer systems, including hardware, software, networking, programming, databases, Internet, ethics and security.

41064	MW	8:00am - 9:10am	Andrews, B		78-2100
	and MW	9:20am - 10:35am	Andrews, B		78-2100
41067	TTh	8:00am - 9:10am	Mason, C		78-2140
	and TTh	9:20am - 10:35am	Mason, C		78-2140
41065	F	8:30am - 11:40am	Zaki, S		79-2280
	and arrange	1.7 hours	Zaki, S		ONLINE

NOTE: CRN 41065 is a Hybrid Class taught partially online with scheduled meetings on campus.

How to Begin Course: Log into Canvas through the eLearning Tools tab in the Mt. SAC portal at my.mtsac.edu. Then click on the Canvas link and then click on CRN for your DL course. **NOTE:** Some courses may not be activated until the start of the term. If you cannot locate your DL course in Canvas when the term starts, contact the professor. **On the first day of classes, log into your DL course to show your "attendance" because not doing so could result in your being dropped from the class for non-attendance.**

Contact info: Email Professor Zaki at either: szakis5@mitsac.edu, through Student Detail Schedule or Canvas at MyMtSAC Portal.

Students must use their Mt. SAC e-mail account and be aware of course commitment and student expectations described at <http://www.mtsac.edu/instruction/learning/distlearn/>

To prepare for a successful online learning experience, see helpful short videos <http://www.mtsac.edu/distancelearning/quiz/>

41066	MW	9:30am - 11:00am	Berry, T		79-2240
	and MW	11:10am - 12:00pm	Berry, T		79-2240
41068	TTh	10:45am - 11:50am	Mason, C		78-2140
	and TTh	12:00pm - 1:10pm	Mason, C		78-2140
41069	TTh	11:30am - 12:50pm	Cameron, J		79-2260
	and TTh	1:00pm - 2:05pm	Cameron, J		79-2260
41071	MW	1:10pm - 2:30pm	Sokol, A		79-2240
	and MW	2:40pm - 3:30pm	Sokol, A		79-2240
41070	M	7:00pm - 10:10pm	Holbert Jr, J		78-2120
	and arrange	1.7 hours	Holbert Jr, J		ONLINE

NOTE: CRN 41070 is a Hybrid Class taught partially online with scheduled meetings on campus.

How to Begin Course: Log into Canvas through the eLearning Tools tab in the Mt. SAC portal at my.mtsac.edu. Then click on the Canvas link and then click on CRN for your DL course. **NOTE:** Some courses may not be activated until the start of the term. If you cannot locate your DL course in Canvas when the term starts, contact the professor. **On the first day of classes, log into your DL course to show your "attendance" because not doing so could result in your being dropped from the class for non-attendance.**

Contact info: Email Professor Holbert at either: jholbert@mitsac.edu, through Student Detail Schedule or Canvas at MyMtSAC Portal.

Students must use their Mt. SAC e-mail account and be aware of course commitment and student expectations described at <http://www.mtsac.edu/instruction/learning/distlearn/>

To prepare for a successful online learning experience, see helpful short videos <http://www.mtsac.edu/distancelearning/quiz/>

41073	arrange	3.4 hours	Blyzka, J		ONLINE
	and arrange	1.7 hours	Blyzka, J		ONLINE

NOTE: CRN 41073 is a Distance Learning Online Class. **How to Begin Course:** Log into Canvas through <http://myportal.mtsac.edu> and click on CRN for your DL course. If you cannot locate your DL course in Canvas, contact the professor. **On the first day of classes, log into your DL course to show your "attendance" because not doing so could result in your being dropped from the class for non-attendance.** **Professor contact info:** Email Professor Blyzka at either: jblyzka@mitsac.edu, through Student Detail Schedule or Canvas at MyMtSAC Portal. **Students must use their Mt. SAC e-mail account and be aware of course commitment and student expectations described at <http://www.mtsac.edu/instruction/learning/distlearn/>**

To prepare for a successful online learning experience, see helpful short videos <http://www.mtsac.edu/distancelearning/quiz/>

41074 arrange 3.4 hours Blyzka, J ONLINE
and arrange 1.7 hours Blyzka, J ONLINE

NOTE: CRN 41074 is a Distance Learning Online Class. **How to Begin Course:** Log into Canvas through <http://myportal.mtsac.edu> and click on CRN for your DL course. If you cannot locate your DL course in Canvas, contact the professor. **On the first day of classes, log into your DL course to show your "attendance" because not doing so could result in your being dropped from the class for non-attendance. Professor contact info:** Email Professor Blyzka at either: jblyzka@mtsac.edu, through Student Detail Schedule or Canvas at MyMtSAC Portal. **Students must use their Mt. SAC e-mail account and be aware of course commitment and student expectations described at <http://www.mtsac.edu/instruction/learning/distlearn/>**

To prepare for a successful online learning experience, see helpful short videos <http://www.mtsac.edu/distancelearning/quiz/>

41075 arrange 3.4 hours Andrews, B ONLINE
and arrange 1.7 hours Andrews, B ONLINE

NOTE: CRN 41075 is a Distance Learning Online Class. **How to Begin Course:** Log into Canvas through <http://myportal.mtsac.edu> and click on CRN for your DL course. If you cannot locate your DL course in Canvas, contact the professor. **On the first day of classes, log into your DL course to show your "attendance" because not doing so could result in your being dropped from the class for non-attendance. Professor contact info:** Email Professor Andrews at either: bandrews@mtsac.edu, through Student Detail Schedule or Canvas at MyMtSAC Portal. **Students must use their Mt. SAC e-mail account and be aware of course commitment and student expectations described at <http://www.mtsac.edu/instruction/learning/distlearn/>**

To prepare for a successful online learning experience, see helpful short videos <http://www.mtsac.edu/distancelearning/quiz/>

■ CISB 15 — Microcomputer Applications 3.5 Units Degree Applicable, CSU, UC

Windows OS and applications: word processing, spreadsheet, database management and presentation software.

41077	MW	8:00am - 9:10am	Patterson, R	78-2120
	and MW	9:20am - 10:35am	Patterson, R	78-2120
41081	TTh	9:45am - 11:00am	STAFF	79-2240
	and TTh	11:10am - 12:00pm	STAFF	79-2240
41079	MW	10:45am - 11:55am	Patterson, R	78-2120
	and MW	12:00pm - 1:10pm	Patterson, R	78-2120
41076	TTh	12:30pm - 1:40pm	Erbe, C	78-2120
	and TTh	1:50pm - 3:05pm	Erbe, C	78-2120
41083	T	7:00pm - 10:10pm	Syiem, J	78-2120
	and arrange	1.7 hours	Syiem, J	ONLINE

NOTE: CRN 41082 is a Hybrid Class taught partially online with scheduled meetings on campus.

How to Begin Course: Log into Canvas through the eLearning Tools tab in the Mt. SAC portal at my.mtsac.edu. Then click on the Canvas link and then click on CRN for your DL course. **NOTE:** Some courses may not be activated until the start of the term. If you cannot locate your DL course in Canvas when the term starts, contact the professor. **On the first day of classes, log into your DL course to show your "attendance" because not doing so could result in your being dropped from the class for non-attendance.**

Contact info: Email Professor Syiem at either: jsyiem@mtsac.edu, through Student Detail Schedule or Canvas at MyMtSAC Portal.

Students must use their Mt. SAC e-mail account and be aware of course commitment and student expectations described at <http://www.mtsac.edu/instruction/learning/distlearn/>

To prepare for a successful online learning experience, see helpful short videos <http://www.mtsac.edu/distancelearning/quiz/>

41082 Th 7:00pm - 10:10pm Zelaya, G 78-2100
and arrange 1.7 hours Zelaya, G ONLINE

NOTE: CRN 41082 is a Hybrid Class taught partially online with scheduled meetings on campus.

How to Begin Course: Log into Moodle rooms through the eLearning Tools tab in the Mt. SAC portal at my.mtsac.edu. Then click on the Moodle rooms link and then click on CRN for your DL course. **NOTE:** Some courses may not be activated until the start of the term. If you cannot locate your DL course in Moodle rooms when the term starts, contact the professor. **On the first day of classes, log into your DL course to show your "attendance" because not doing so could result in your being dropped from the class for non-attendance.**

Professor contact info: Email Professor Zelaya at either: GZelaya@mtsac.edu, through Student Detail Schedule or Moodle rooms at MyMtSAC Portal.

Students must use their Mt. SAC e-mail account and be aware of course commitment and student expectations described at <http://www.mtsac.edu/instruction/learning/distlearn/>

To prepare for a successful online learning experience, see helpful short videos <http://www.mtsac.edu/distancelearning/quiz/>

41080 arrange 3.4 hours Mehta, J ONLINE
and arrange 1.7 hours Mehta, J ONLINE

NOTE: CRN 41080 is a Distance Learning Online Class. **How to Begin Course:** Log into Canvas through <http://myportal.mtsac.edu> and click on CRN for your DL course. If you cannot locate your DL course in Canvas, contact the professor. **On the first day of classes, log into your DL course to show your "attendance" because not doing so could result in your being dropped from the class for non-attendance. Professor contact info:** Email Professor Mehta at either: jmehta@mtsac.edu, through Student Detail Schedule or Canvas at MyMtSAC Portal. **Students must use their Mt. SAC e-mail account and be aware of course commitment and student expectations described at <http://www.mtsac.edu/instruction/learning/distlearn/>**

To prepare for a successful online learning experience, see helpful short videos <http://www.mtsac.edu/distancelearning/quiz/>

41084 arrange 3.4 hours Degtyareva, A ONLINE
and arrange 1.7 hours Degtyareva, A ONLINE

NOTE: CRN 41084 is a Distance Learning Online Class. **How to Begin Course:** Log into Canvas through <http://myportal.mtsac.edu> and click on CRN for your DL course. If you cannot locate your DL course in Canvas, contact the professor. **On the first day of classes, log into your DL course to show your "attendance" because not doing so could result in your being dropped from the class for non-attendance. Professor contact info:** Email Professor Degtyareva at either: adegtyareva@mtsac.edu, through Student Detail Schedule or Canvas at MyMtSAC Portal. **Students must use their Mt. SAC e-mail account and be aware of course commitment and student expectations described at <http://www.mtsac.edu/instruction/learning/distlearn/>**

To prepare for a successful online learning experience, see helpful short videos <http://www.mtsac.edu/distancelearning/quiz/>

41184 arrange 3.4 hours Mehta, J ONLINE
and arrange 1.7 hours Mehta, J ONLINE

NOTE: CRN 41184 is a Distance Learning Online Class. **How to Begin Course:** Log into Canvas through <http://myportal.mtsac.edu> and click on CRN for your DL course. If you cannot locate your DL course in Canvas, contact the professor. **On the first day of classes, log into your DL course to show your "attendance" because not doing so could result in your being dropped from the class for non-attendance. Professor contact info:** Email Professor Mehta at either: jmehta@mtsac.edu, through Student Detail Schedule or Canvas at MyMtSAC Portal. **Students must use their Mt. SAC e-mail account and be aware of course commitment and student expectations described at <http://www.mtsac.edu/instruction/learning/distlearn/>**

To prepare for a successful online learning experience, see helpful short videos <http://www.mtsac.edu/distancelearning/quiz/>

■ CISB 16 — Macintosh Applications **2.0 Units**

Degree Applicable, CSU

Macintosh operating system and related tools; creating files using office applications; storing and sharing files using iCloud.

44066	M	6:30pm - 7:50pm	Hartmann, C	78-2110
and	M	8:00pm - 9:50pm	Hartmann, C	78-2110

■ CISB 21 — Microsoft Excel **3.0 Units**

Degree Applicable, CSU

Spreadsheet concepts using Microsoft Excel: formats, formulas, functions, and macros to build and maintain spreadsheets.

41085	TTh	10:00am - 11:25am	Mehta, J	78-2120
41185	MW	1:15pm - 2:40pm	Berry, T	78-2100
41177	W	6:30pm - 9:40pm	Kowalski, F	79-2240

■ CISB 31 — Microsoft Word **3.0 Units**

Degree Applicable

(May be taken for option of Letter grade or Pass/NoPass)

Advisory: Ability to type 25 words a minute or CISI 11

Word processing with Microsoft Word to create, edit, and format business and publication documents.

41086	TTh	10:30am - 11:55am	Erbe, C	79-2280
-------	-----	-------------------	---------	---------

■ CISB 51 — Microsoft PowerPoint **3.0 Units**

Degree Applicable, CSU

Using PowerPoint to design and create effective professional presentations.

41087	M	7:00pm - 10:10pm	Syiem, P	79-2260
-------	---	------------------	----------	---------

COMPUTER INFORMATION SYSTEMS: DATABASE
■ CISD 11 — Database Management - Microsoft Access **3.0 Units**

Degree Applicable, CSU

*Corequisite: CISD 11L**Advisory: CISB 15 or CISB 11*

Design, creation, and management of relational databases using Microsoft Access.

41088	W	7:00pm - 8:30pm	Patterson, R	79-2280
and arrange		1.6 hours	Patterson, R	ONLINE

NOTE:CRN 41088 is a Hybrid Class taught partially online with scheduled meetings on campus.

How to Begin Course: Log into Canvas through the eLearning Tools tab in the Mt. SAC portal at my.mtsac.edu. Then click on the Canvas link and then click on CRN for your DL course. **NOTE:** Some courses may not be activated until the start of the term. If you cannot locate your DL course in Canvas when the term starts, contact the professor. **On the first day of classes, log into your DL course to show your "attendance" because not doing so could result in your being dropped from the class for non-attendance.**

Contact info: Email Professor Patterson at either: rpatterson@mtsac.edu, through Student Detail Schedule or Canvas at MyMtSAC Portal.

Students must use their Mt. SAC e-mail account and be aware of course commitment and student expectations described at <http://www.mtsac.edu/instruction/learning/distlearn/>

To prepare for a successful online learning experience, see helpful short videos <http://www.mtsac.edu/distancelearning/quiz/>

■ CISD 11L — Database Management - Microsoft Access Laboratory **.5 Unit**

Degree Applicable, CSU

Corequisite: CISD 11

Lab for CISD 11-Database Management-Microsoft Access.

41089	W	8:45pm - 10:10pm	Patterson, R	79-2280
-------	---	------------------	--------------	---------

COMPUTER SKILLS FOR LIFE!

Learn how *hardware, software* and *Internet basics* can empower you with *lifelong skills*.

Enroll in Computer Information Systems-CIS



Enroll now in
CISB 11
and **CISB 15**

Visit: <http://cis.mtsac.edu>

■ CISD 21 — Database Management - Microsoft SQL Server **3.0 Units**

Degree Applicable, CSU

*Corequisite: CISD 21L**Advisory: CISB 11 or CISB 15*

Structured Query Language (SQL) and Transact-SQL for Microsoft SQL Server. Concurrent enrollment in CISD 21L is required.

41090	W	7:00pm - 8:30pm	Blyzka, J	78-2120
and arrange		1.6 hours	Blyzka, J	ONLINE

NOTE:CRN 41190 is a Hybrid Class taught partially online with scheduled meetings on campus.

How to Begin Course: Log into Canvas through the eLearning Tools tab in the Mt. SAC portal at my.mtsac.edu. Then click on the Canvas link and then click on CRN for your DL course. **NOTE:** Some courses may not be activated until the start of the term. If you cannot locate your DL course in Canvas when the term starts, contact the professor. **On the first day of classes, log into your DL course to show your "attendance" because not doing so could result in your being dropped from the class for non-attendance.**

Contact info: Email Professor Blyzka at either: jblyzka@mtsac.edu, through Student Detail Schedule or Canvas at MyMtSAC Portal.

Students must use their Mt. SAC e-mail account and be aware of course commitment and student expectations described at <http://www.mtsac.edu/instruction/learning/distlearn/>

To prepare for a successful online learning experience, see helpful short videos <http://www.mtsac.edu/distancelearning/quiz/>

■ CISD 21L — Database Management - Microsoft SQL Server Laboratory **.5 Unit**

Degree Applicable, CSU

Corequisite: CISD 21

Lab for CISD 21 - SQL Server. Student must be enrolled in CISD 21, a concurrent lecture co-requisite.

41091	W	8:45pm - 10:10pm	Blyzka, J	78-2120
-------	---	------------------	-----------	---------

■ **CISD 31 — Database Management - Oracle** **3.0 Units**
Degree Applicable, CSU

Corequisite: CISD 31L

Advisory: CISB 11 or CISB 15

Oracle SQL queries, PL/SQL is used to test and implement procedures, triggers, and packages. CISD 31L is required co-requisite.

41092 Th 7:00pm - 8:30pm Zaki, S 79-2260
and arrange 1.6 hours Zaki, S ONLINE

NOTE: CRN 41092 is a Hybrid Class taught partially online with scheduled meetings on campus.

How to Begin Course: Log into Canvas through the eLearning Tools tab in the Mt. SAC portal at my.mtsac.edu. Then click on the Canvas link and then click on CRN for your DL course. **NOTE:** Some courses may not be activated until the start of the term. If you cannot locate your DL course in Canvas when the term starts, contact the professor. **On the first day of classes, log into your DL course to show your "attendance" because not doing so could result in your being dropped from the class for non-attendance.**

Contact info: Email Professor Zaki at either: szaki5@mtsac.edu, through Student Detail Schedule or Canvas at MyMtSAC Portal.

Students must use their Mt. SAC e-mail account and be aware of course commitment and student expectations described at <http://www.mtsac.edu/instruction/learning/distlearn/>

To prepare for a successful online learning experience, see helpful short videos <http://www.mtsac.edu/distancelearning/quiz/>

■ **CISD 31L — Database Management - Oracle Laboratory** **.5 Unit**
Degree Applicable, CSU

Corequisite: CISD 31

Concurrent lab for CISD 31 - Database Management - Oracle. Student must also be enrolled in CISD 31.

41093 Th 8:45pm - 10:10pm Zaki, S 79-2260

■ **CISD 40 — Database Design** **3.0 Units**
Degree Applicable, CSU

Advisory: CISD 11 and CISD 11L

Database design principles including data modeling, E-R and UML diagrams and normalization rules.

41094 T 7:00pm - 10:10pm Orefice, V 79-2240

COMPUTER INFORMATION SYSTEMS: MANAGEMENT

■ **CISM 11 — Systems Analysis and Design** **3.5 Units**
Degree Applicable, CSU, UC

Advisory: CISB 11

Application of structured analysis and design methods and tools in the development of information systems, including CASE tools.

44067 M 6:55pm - 8:45pm Orefice, V 78-2140
and M 8:55pm - 10:15pm Orefice, V 78-2140
and arrange 1.7 hours STAFF ONLINE

COMPUTER INFORMATION SYSTEMS: NETWORKING

■ **CISN 11 — Telecommunications Networking** **3.0 Units**
Degree Applicable, CSU

Corequisite: CISN 11L

Advisory: CISB 11

Prepares for Cisco CCNA 1st year and Network+ certification.

41095 TTh 9:30am - 10:55am Andrews, B 78-2100

NOTE: CISN (CRN 41095) is linked to CISNL (CRN 41096). If you are interested in enrolling in these courses, you must enter both CRN's (41095 and 41096) to register.

41097 W 7:00pm - 10:10pm Andrews, B 78-2100

NOTE: CISN (CRN 41097) is linked to CISNL (CRN 41098). If you are interested in enrolling in these courses, you must enter both CRN's (41097 and 41098) to register.

■ **CISN 11L — Telecommunications/Networking Laboratory** **.5 Unit**
Degree Applicable, CSU

Corequisite: CISN 11

Hands-on lab for CISN11 Telecomm/Networking. Student must be enrolled in CISN 11, a concurrent lecture co-requisite.

41096 T 11:15am - 12:40pm Andrews, B 78-2100

NOTE: CISNL (CRN 41096) is linked to CISN (CRN 41095). If you are interested in enrolling in these courses, you must enter both CRN's (41096 and 41095) to register.

41098 W 5:15pm - 6:40pm Andrews, B 78-2100

NOTE: CISNL (CRN 41098) is linked to CISN (CRN 41097). If you are interested in enrolling in these courses, you must enter both CRN's (41098 and 41097) to register.

■ **CISN 21 — Windows Operating System** **3.0 Units**
Degree Applicable, CSU

Advisory: CISB 11 or CISB 15

Windows operating system installation and performance tweaking, hardware and software issues, system files, and security.

41099 F 8:00am - 11:10am Blyzka, J 78-2100

■ **CISN 24 — Window Server Network and Security Administration** **3.0 Units**
Degree Applicable, CSU

Corequisite: CISN 24L

Advisory: CISN 11

Computer Network Administration and Security Management (CNASM) core and Microsoft Server Certification topics.

41100 F 5:30pm - 7:00pm Gau, J 78-2135
and arrange 1.6 hours STAFF ONLINE

NOTE: CRN 41100 is a Hybrid Class taught partially online with scheduled meetings on campus.

How to Begin Course: Log into Canvas through the eLearning Tools tab in the Mt. SAC portal at my.mtsac.edu. Then click on the Canvas link and then click on CRN for your DL course. **NOTE:** Some courses may not be activated until the start of the term. If you cannot locate your DL course in Canvas when the term starts, contact the professor. **On the first day of classes, log into your DL course to show your "attendance" because not doing so could result in your being dropped from the class for non-attendance.**

Contact info: Email Professor Gau at either: jgau@mtsac.edu, through Student Detail Schedule or Canvas at MyMtSAC Portal.

Students must use their Mt. SAC e-mail account and be aware of course commitment and student expectations described at <http://www.mtsac.edu/instruction/learning/distlearn/>

To prepare for a successful online learning experience, see helpful short videos <http://www.mtsac.edu/distancelearning/quiz/>

■ **CISN 24L — Window Server Network and Security Administration Laboratory** **.5 Unit**
Degree Applicable, CSU

Corequisite: CISN 24

Lab applications for CISN 24 Window Server Network and Security Administration. Student must be concurrently enrolled in CISN 24.

41101 F 7:10pm - 8:40pm Gau, J 78-2135

■ **CISN 31 — Linux Operating System** **3.0 Units**
Degree Applicable, CSU

Corequisite: CISN 31L

Advisory: CISB 11

Concepts and skills in planning, installing and managing Linux OS and its GUI. Student must take CISN 31L concurrently.

41102 M 1:15pm - 2:40pm Zamora, V 78-2140
and arrange 1.6 hours Zamora, V ONLINE

NOTE:CRN 40275 is a Hybrid Class taught partially online with scheduled meetings on campus.

How to Begin Course: Log into Moodlerooms through the eLearning Tools tab in the Mt. SAC portal at my.mtsac.edu. Then click on the Moodlerooms link and then click on CRN for your DL course.

NOTE: Some courses may not be activated until the start of the term. If you cannot locate your DL course in Moodlerooms when the term starts, contact the professor. **On the first day of classes, log into your DL course to show your "attendance" because not doing so could result in your being dropped from the class for non-attendance.**

Professor contact info: Email Professor Zamora at either: VZamora@mtsac.edu, through Student Detail Schedule or Moodlerooms at MyMtSAC Portal.

Students must use their Mt. SAC e-mail account and be aware of course commitment and student expectations described at <http://www.mtsac.edu/instruction/learning/distlearn/>

To prepare for a successful online learning experience, see helpful short videos <http://www.mtsac.edu/distancelearning/quiz/>

■ **CISN 31L — Linux Operating System Laboratory** **.5 Unit**
Degree Applicable, CSU

Corequisite: CISN 31

Laboratory for planning, installing, and managing Linux OS and its GUI. Student must take CISN 31 concurrently.

41103 M 3:00pm - 4:25pm Zamora, V 78-2140

■ **CISN 34 — Linux Networking and Security** **3.0 Units**
Degree Applicable, CSU

Corequisite: CISN 34L

Advisory: CISN 31

Installation and management of Linux operating system networks and security modules. Student must take CISN 34L concurrently.

44075 W 1:15pm - 2:40pm Zamora, V 78-2140
and arrange 1.6 hours Zamora, V ONLINE

NOTE:CRN 44075 is a Hybrid Class taught partially online with scheduled meetings on campus.

How to Begin Course: Log into Canvas through the eLearning Tools tab in the Mt. SAC portal at my.mtsac.edu. Then click on the Canvas link and then click on CRN for your DL course. **NOTE:** Some courses may not be activated until the start of the term. If you cannot locate your DL course in Canvas when the term starts, contact the professor. **On the first day of classes, log into your DL course to show your "attendance" because not doing so could result in your being dropped from the class for non-attendance.**

Contact info: Email Professor Zamora at either: vzamora@mtsac.edu, through Student Detail Schedule or Canvas at MyMtSAC Portal.

Students must use their Mt. SAC e-mail account and be aware of course commitment and student expectations described at <http://www.mtsac.edu/instruction/learning/distlearn/>

To prepare for a successful online learning experience, see helpful short videos <http://www.mtsac.edu/distancelearning/quiz/>

■ **CISN 34L — Linux Networking and Security Laboratory** **.5 Unit**
Degree Applicable, CSU

Corequisite: CISN 34

Lab for installation and management of Linux networks and security modules. Student must take CISN 34 lecture course concurrently.

44083 W 3:00pm - 4:25pm Zamora, V 78-2140

■ **CISN 51 — Cisco CCNA Networking and Routing** **3.0 Units**
Degree Applicable, CSU

Corequisite: CISN 51L

Advisory: CISN 11

CNASM core lecture course. Preparation for CCNA exam. Student must be enrolled in CISN 51L, a concurrent lab co-requisite.

41104 M 7:00pm - 8:30pm Gau, J 78-2135
and arrange 1.6 hours Gau, J ONLINE

NOTE:CRN 41104 is a Hybrid Class taught partially online with scheduled meetings on campus.

How to Begin Course: Log into Canvas through the eLearning Tools tab in the Mt. SAC portal at my.mtsac.edu. Then click on the Canvas link and then click on CRN for your DL course. **NOTE:** Some courses may not be activated until the start of the term. If you cannot locate your DL course in Canvas when the term starts, contact the professor. **On the first day of classes, log into your DL course to show your "attendance" because not doing so could result in your being dropped from the class for non-attendance.**

Contact info: Email Professor Gau at either: jgau@mtsac.edu, through Student Detail Schedule or Canvas at MyMtSAC Portal.

Students must use their Mt. SAC e-mail account and be aware of course commitment and student expectations described at <http://www.mtsac.edu/instruction/learning/distlearn/>

To prepare for a successful online learning experience, see helpful short videos <http://www.mtsac.edu/distancelearning/quiz/>

■ **CISN 51L — Cisco CCNA Networking and Routing Laboratory** **.5 Unit**
Degree Applicable, CSU

Corequisite: CISN 51

CISN51 Cisco CCNA Networking and Routing lab course. Concurrent enrollment in CISN 51 is required.

41105 M 8:45pm - 10:10pm Gau, J 78-2135

■ **CISN 61 — Virtualization Technology** **3.0 Units**
Degree Applicable

Advisory: CISB 11 or CISN 21 or CISN 31

Plan, configure, secure, install, and maintain latest virtual systems from prominent vendors.

41242 M 7:00pm - 10:10pm Rubio, J 78-2155

COMPUTER INFORMATION SYSTEMS: PROGRAMMING

■ CISP 10 — Principles of Object-Oriented Design 2.5 Units

Degree Applicable, CSU

Advisory: Advisory corequisites CISP 11 or CISP 21 or CISP 31 or CISP 41
Object-oriented design, patterns, and use of UML in different programming languages. Covers Agile and Scrum

41148	W	3:30pm - 4:50pm	Degtyareva, A	79-2260
and	W	5:00pm - 6:30pm	Degtyareva, A	79-2260
		and arrange 1.67 hours	Degtyareva, A	ONLINE

NOTE:CRN 41148 is a Hybrid Class taught partially online with scheduled meetings on campus.

How to Begin Course: Log into Canvas through the eLearning Tools tab in the Mt. SAC portal at my.mtsac.edu. Then click on the Canvas link and then click on CRN for your DL course. **NOTE:** Some courses may not be activated until the start of the term. If you cannot locate your DL course in Canvas when the term starts, contact the professor. **On the first day of classes, log into your DL course to show your "attendance" because not doing so could result in your being dropped from the class for non-attendance.**

Contact info: Email Professor Degtyareva at either: adegtyareva@mtsac.edu, through Student Detail Schedule or Canvas at MyMtSAC Portal.

Students must use their Mt. SAC e-mail account and be aware of course commitment and student expectations described at <http://www.mtsac.edu/instruction/learning/distlearn/>

To prepare for a successful online learning experience, see helpful short videos <http://www.mtsac.edu/distancelearning/quiz/>

41106	T	7:00pm - 8:25pm	Zamora, V	78-2140
and	T	8:40pm - 10:10pm	Zamora, V	78-2140
		and arrange 1.65 hours	STAFF	ONLINE

■ CISP 11 — Programming in Visual Basic 3.0 Units

Degree Applicable, CSU, UC

Corequisite: CISP 11L

Advisory: CISP 11 or CISP 15 or CISP 10

VB Programming using object-oriented apps, control structures, and database access.

41107	T	8:00am - 11:10am	Patterson, R	79-2260
-------	---	------------------	--------------	---------

■ CISP 11L — Programming in Visual Basic Laboratory .5 Unit

Degree Applicable, CSU, UC

Corequisite: CISP 11

Laboratory for CISP 11 Programming in VB.

41108	Th	8:00am - 9:25am	Patterson, R	79-2260
-------	----	-----------------	--------------	---------

■ CISP 14 — Advanced Visual Basic .NET 3.0 Units

Degree Applicable, CSU, UC

Corequisite: CISP 14L

Advisory: CISP 11 and CISP 11L

VB .NET multi-tier programs for databases, Web services, user controls and mobile devices. Must take CISP 14L concurrently.

44117	W	7:00pm - 8:30pm	Paz, R	78-2135
		and arrange 1.62 hours	Paz, R	

■ CISP 14L — Advanced Visual Basic.NET Laboratory .5 Unit

Degree Applicable, CSU, UC

Corequisite: CISP 14

Advisory: CISP 11 and CISP 11L

VB .NET programming lab for databases, Web services, user controls and mobile devices. Student must take CISP 14 concurrently.

44118	W	8:40pm - 10:10pm	Paz, R	78-2135
-------	---	------------------	--------	---------

■ CISP 21 — Programming in Java

3.0 Units

Degree Applicable, CSU, UC

Corequisite: CISP 21L

Advisory: CISP 10 AND (CISP 11 OR CISP 15)

Design and development of object-oriented Java programming applications. Student must take CISP 21L concurrently.

41203	MW	9:30am - 10:55am	Mehta, J	79-2280
-------	----	------------------	----------	---------

NOTE: HYBRID CLASSES

CRN 41203 is a Hybrid Class taught partially online with scheduled meetings on campus and is linked to CISP21L (CRN 41109). If you are interested in enrolling in these courses, you must enter both CRNs (41203 and 41109) to register

How to Begin Course: Log into Canvas through the eLearning Tools tab in the Mt. SAC portal at my.mtsac.edu. Then click on the Canvas link and then click on CRN for your DL course. **NOTE:** Some courses may not be activated until the start of the term. If you cannot locate your DL course in Canvas when the term starts, contact the professor. **On the first day of classes, log into your DL course to show your "attendance" because not doing so could result in your being dropped from the class for non-attendance.**

Contact info: Email Professor Mehta at either: jmehta@mtsac.edu, through Student Detail Schedule or Canvas at MyMtSAC Portal.

Students must use their Mt. SAC e-mail account and be aware of course commitment and student expectations described at <http://www.mtsac.edu/instruction/learning/distlearn/>

To prepare for a successful online learning experience, see helpful short videos <http://www.mtsac.edu/distancelearning/quiz/>

41204	M	7:00pm - 8:30pm	Zaki, S	79-2240
		and arrange 1.55 hours	Zaki, S	ONLINE

NOTE:CRN 41204 is a Hybrid Class taught partially online with scheduled meetings on campus and is linked to CISP21L (CRN 41104). If you are interested in enrolling in these courses, you must enter both CRNs (41204 and 41104) to register

How to Begin Course: Log into Canvas through the eLearning Tools tab in the Mt. SAC portal at my.mtsac.edu. Then click on the Canvas link and then click on CRN for your DL course. **NOTE:** Some courses may not be activated until the start of the term. If you cannot locate your DL course in Canvas when the term starts, contact the professor. **On the first day of classes, log into your DL course to show your "attendance" because not doing so could result in your being dropped from the class for non-attendance.**

Contact info: Email Professor Zaki at either: szaki@mtsac.edu, through Student Detail Schedule or Canvas at MyMtSAC Portal.

Students must use their Mt. SAC e-mail account and be aware of course commitment and student expectations described at <http://www.mtsac.edu/instruction/learning/distlearn/>

To prepare for a successful online learning experience, see helpful short videos <http://www.mtsac.edu/distancelearning/quiz/>

■ CISP 21L — Programming in Java Laboratory .5 Unit

Degree Applicable, CSU, UC

Corequisite: CISP 21

Programming lab for CISP 21 - Programming in Java. Student must be enrolled in CISP 21, a concurrent lecture co-requisite.

41109	M	11:15am - 12:40pm	Mehta, J	79-2280
-------	---	-------------------	----------	---------

NOTE: CISP21L (CRN 41109) is linked to CISP21(CRN 41203). If you are interested in enrolling in these courses, you must enter both CRN's (41109 and 41203) to register.

41110	M	8:45pm - 10:10pm	Zaki, S	79-2240
-------	---	------------------	---------	---------

NOTE: CISP21L (CRN 41110) is linked to CISP21(CRN 41204). If you are interested in enrolling in these courses, you must enter both CRN's (41110 and 41204) to register.

■ **CISP 31 — Programming in C++** **3.0 Units**
Degree Applicable, CSU, UC

Corequisite: CISP 31L

Advisory: CISP 10 or (CISP 11 and CISP 11L) or (CISP 21 and CISP 21L)

Object-oriented programming in C++ including design, documentation, and debugging. Student must take CISP 31L concurrently.

41111 MW 8:00am - 9:30am Degtyareva, A 78-2110
and arrange 3.15 hours Degtyareva, A ONLINE
8 Weeks, Week beginning 02/26/2018 ending 04/22/2018

NOTE:CRN 41111 is a Hybrid Class taught partially online with scheduled meetings on campus and is linked to CISP31L (CRN 41114). If you are interested in enrolling in these courses, you must enter both CRNs (41111 and 41114) to register.

How to Begin Course: Log into Canvas through the eLearning Tools tab in the Mt. SAC portal at my.mtsac.edu. Then click on the Canvas link and then click on CRN for your DL course. **NOTE:** Some courses may not be activated until the start of the term. If you cannot locate your DL course in Canvas when the term starts, contact the professor. **On the first day of classes, log into your DL course to show your "attendance" because not doing so could result in your being dropped from the class for non-attendance.**

Contact info: Email Professor Degtyareva at either: adegtyareva@mtsac.edu, through Student Detail Schedule or Canvas at MyMtSAC Portal.

Students must use their Mt. SAC e-mail account and be aware of course commitment and student expectations described at <http://www.mtsac.edu/instruction/learning/distlearn/>

To prepare for a successful online learning experience, see helpful short videos <http://www.mtsac.edu/distancelearning/quiz/>

41112 T 1:40pm - 5:00pm Degtyareva, A 78-2110
and arrange 3.25 hours Degtyareva, A ONLINE
8 Weeks, Week beginning 02/26/2018 ending 04/22/2018

NOTE:CRN 41112 is a Hybrid Class taught partially online with scheduled meetings on campus and is linked to CISP31L (CRN 41115). If you are interested in enrolling in these courses, you must enter both CRNs (41112 and 41115) to register.

How to Begin Course: Log into Canvas through the eLearning Tools tab in the Mt. SAC portal at my.mtsac.edu. Then click on the Canvas link and then click on CRN for your DL course. **NOTE:** Some courses may not be activated until the start of the term. If you cannot locate your DL course in Canvas when the term starts, contact the professor. **On the first day of classes, log into your DL course to show your "attendance" because not doing so could result in your being dropped from the class for non-attendance.**

Contact info: Email Professor Degtyareva at either: adegtyareva@mtsac.edu, through Student Detail Schedule or Canvas at MyMtSAC Portal.

Students must use their Mt. SAC e-mail account and be aware of course commitment and student expectations described at <http://www.mtsac.edu/instruction/learning/distlearn/>

To prepare for a successful online learning experience, see helpful short videos <http://www.mtsac.edu/distancelearning/quiz/>

41113 TTh 7:00pm - 8:30pm Degtyareva, A 78-2110
and arrange 3.6 hours Degtyareva, A ONLINE
8 Weeks, Week beginning 02/26/2018 ending 04/22/2018

NOTE:CRN 41113 is a Hybrid Class taught partially online with scheduled meetings on campus and is linked to CISP31L (CRN 41116). If you are interested in enrolling in these courses, you must enter both CRNs (41113 and 41116) to register.

How to Begin Course: Log into Canvas through the eLearning Tools tab in the Mt. SAC portal at my.mtsac.edu. Then click on the Canvas link and then click on CRN for your DL course. **NOTE:** Some courses may not be activated until the start of the term. If you cannot locate your DL course in Canvas when the term starts, contact the professor. **On the first day of classes, log into your DL course to show your "attendance" because not doing so could result in your being dropped from the class for non-attendance.**

Contact info: Email Professor Degtyareva at either: adegtyareva@mtsac.edu, through Student Detail Schedule or Canvas at MyMtSAC Portal.

Students must use their Mt. SAC e-mail account and be aware of course commitment and student expectations described at <http://www.mtsac.edu/instruction/learning/distlearn/>

To prepare for a successful online learning experience, see helpful short videos <http://www.mtsac.edu/distancelearning/quiz/>

■ **CISP 31L — Programming in C++ Laboratory** **.5 Unit**
Degree Applicable, CSU, UC

Corequisite: CISP 31

Lab for object-oriented programming in C++ including design, documentation, and debugging. Student must take CISP 31 concurrently.

41114 MW 9:45am - 11:15am Degtyareva, A 78-2110
8 Weeks, Week beginning 02/26/2018 ending 04/22/2018

NOTE: CISP31L (CRN 41114) is linked to CISP31(CRN 41111). If you are interested in enrolling in these courses, you must enter both CRN's (41114 and 41111) to register.

41115 TTh 5:15pm - 6:40pm Degtyareva, A 78-2110
8 Weeks, Week beginning 02/26/2018 ending 04/22/2018

NOTE: CISP31L (CRN 41115) is linked to CISP31(CRN 41112). If you are interested in enrolling in these courses, you must enter both CRN's (41115 and 41112) to register.

41116 TTh 8:40pm - 10:10pm Degtyareva, A 78-2110
8 Weeks, Week beginning 02/26/2018 ending 04/22/2018

NOTE: CISP31L (CRN 41116) is linked to CISP31(CRN 41113). If you are interested in enrolling in these courses, you must enter both CRN's (41116 and 41113) to register.

■ **CISP 34 — Advanced C++ Programming** **3.0 Units**
Degree Applicable, CSU, UC

Corequisite: CISP 34L

Advisory: CISP 31 and CISP 31L

Object-oriented programming in C++. Covers data structures, GUI, database, web services. Student must take CISP 34L concurrently.

41117 TTh 7:00pm - 8:30pm Degtyareva, A 78-2110
and arrange 3.15 hours Degtyareva, A
8 Weeks, Week beginning 04/23/2018 ending 06/17/2018

NOTE:CRN 41117 is a Hybrid Class taught partially online with scheduled meetings on campus.

How to Begin Course: Log into Canvas through the eLearning Tools tab in the Mt. SAC portal at my.mtsac.edu. Then click on the Canvas link and then click on CRN for your DL course. **NOTE:** Some courses may not be activated until the start of the term. If you cannot locate your DL course in Canvas when the term starts, contact the professor. **On the first day of classes, log into your DL course to show your "attendance" because not doing so could result in your being dropped from the class for non-attendance.**

Contact info: Email Professor Degtyareva at either: adegtyareva@mtsac.edu, through Student Detail Schedule or Canvas at MyMtSAC Portal.

Students must use their Mt. SAC e-mail account and be aware of course commitment and student expectations described at <http://www.mtsac.edu/instruction/learning/distlearn/>

To prepare for a successful online learning experience, see helpful short videos <http://www.mtsac.edu/distancelearning/quiz/>

■ **CISP 34L — Advanced C++ Programming Laboratory** .5 Unit
Degree Applicable, CSU, UC

Corequisite: CISP 34

C++ Object-oriented programming lab. Covers data structures, GUI, database, web services. Student must take CISP 34 concurrently.

41118 TTh 8:45pm - 10:10pm Degtyareva, A 78-2110
8 Weeks, Week beginning 04/23/2018 ending 06/17/2018

■ **CISP 54 — Programming for Android Devices** 3.0 Units
Degree Applicable

Corequisite: CISP54L

Advisory: CISP10, CISP52 and CISP52L

Android device programming, interface patterns, design, connectivity, and app architecture. Focus on creating effective mobile apps.

44157 M 12:00pm - 1:25pm Zaki, S 78-2110
and arrange 1.78 hours Zaki, S ONLINE

NOTE:CRN 44157 is a Hybrid Class taught partially online with scheduled meetings on campus.

How to Begin Course: Log into Canvas through the eLearning Tools tab in the Mt. SAC portal at my.mtsac.edu. Then click on the Canvas link and then click on CRN for your DL course. **NOTE:** Some courses may not be activated until the start of the term. If you cannot locate your DL course in Canvas when the term starts, contact the professor. **On the first day of classes, log into your DL course to show your "attendance" because not doing so could result in your being dropped from the class for non-attendance.**

Contact info: Email Professor Zaki at either: szaki@mtsac.edu, through Student Detail Schedule or Canvas at MyMtSAC Portal.

Students must use their Mt. SAC e-mail account and be aware of course commitment and student expectations described at <http://www.mtsac.edu/instruction/learning/distlearn/>

To prepare for a successful online learning experience, see helpful short videos <http://www.mtsac.edu/distancelearning/quiz/>

■ **CISP 54L — Android Programming Laboratory** .5 Unit
Degree Applicable

Corequisite: CISP54

Lab for Android programming user interface, connectivity, and app architecture and design. Student must take CISP 54 concurrently.

44158 M 1:40pm - 3:10pm Zaki, S 78-2110

■ **CISP 61 — Introduction to Game Programming** 3.0 Units
Not Degree Applicable

Corequisite: CISP 61L

Advisory: CISP 31 and CISP 34

Game programming technologies and techniques. Student must be enrolled in CISP 61L concurrently.

44159 T 5:15pm - 8:25pm Dy, H 79-2280

■ **CISP 61L — Introduction to Game Programming Laboratory** .5 Unit
Not Degree Applicable

Corequisite: CISP 61

Provides practical implementation of game development using different software packages

44162 T 8:35pm - 10:00pm Dy, H 79-2280

COMPUTER INFORMATION SYSTEMS: SECURITY

■ **CISS 15 — Operating Systems Security** 3.0 Units
Degree Applicable

Advisory: CIBS 11 or CIBS 21

Operating systems security concepts and techniques for Windows, Unix, Linux, etc.

44166 T 7:00pm - 10:10pm Chiu, P 78-2135

■ **CISS 21 — Network Vulnerabilities and Countermeasures** 3.0 Units
Degree Applicable, CSU

Corequisite: CISS 21L

Advisory: CIBS 11 or CIBS 24 or CIBS 51

Network vulnerabilities from a hacker's perspective. Student must take CISS 21L concurrently

41119 T 7:00pm - 8:30pm Rubio, J 78-2155
and arrange 1.6 hours Rubio, J ONLINE

NOTE:CRN 41119 is a Hybrid Class taught partially online with scheduled meetings on campus.

How to Begin Course: Log into Canvas through the eLearning Tools tab in the Mt. SAC portal at my.mtsac.edu. Then click on the Canvas link and then click on CRN for your DL course. **NOTE:** Some courses may not be activated until the start of the term. If you cannot locate your DL course in Canvas when the term starts, contact the professor. **On the first day of classes, log into your DL course to show your "attendance" because not doing so could result in your being dropped from the class for non-attendance.**

Contact info: Email Professor Rubio at either: jesus.rubio@mtsac.edu, through Student Detail Schedule or Canvas at MyMtSAC Portal.

Students must use their Mt. SAC e-mail account and be aware of course commitment and student expectations described at <http://www.mtsac.edu/instruction/learning/distlearn/>

To prepare for a successful online learning experience, see helpful short videos <http://www.mtsac.edu/distancelearning/quiz/>

■ **CISS 21L — Network Vulnerabilities and Countermeasures Laboratory** .5 Unit
Degree Applicable, CSU

Corequisite: CISS 21

Lab for network vulnerabilities from a hacker's perspective. Cyber legal ethical issues. Student must take CISS 21 concurrently.

41120 T 8:45pm - 10:10pm Rubio, J 78-2155

■ **CISS 23 — Network Analysis, Intrusion Detection/Prevention Systems** 3.0 Units
Degree Applicable, CSU

Corequisite: CISS 23L

Advisory: CIBS 11 or CIBS 24 or CIBS 51

WireShark and Netflow to troubleshoot monitor network. Detect and block network attack w/IPS. Student must take CISS 23L concurrently.

41121 Th 7:00pm - 8:30pm Rubio, J 78-2155
and arrange 1.6 hours Rubio, J ONLINE

NOTE:CRN 41121 is a Hybrid Class taught partially online with scheduled meetings on campus.

How to Begin Course: Log into Canvas through the eLearning Tools tab in the Mt. SAC portal at my.mtsac.edu. Then click on the Canvas link and then click on CRN for your DL course. **NOTE:** Some courses may not be activated until the start of the term. If you cannot locate your DL course in Canvas when the term starts, contact the professor. **On the first day of classes, log into your DL course to show your "attendance" because not doing so could result in your being dropped from the class for non-attendance.**

Contact info: Email Professor Rubio at either: jesus.rubio@mtsac.edu, through Student Detail Schedule or Canvas at MyMtSAC Portal.

Students must use their Mt. SAC e-mail account and be aware of course commitment and student expectations described at <http://www.mtsac.edu/instruction/learning/distlearn/>

To prepare for a successful online learning experience, see helpful short videos <http://www.mtsac.edu/distancelearning/quiz/>

■ **CISS 23L — Network Analysis, Intrusion Detection/Prevention Systems Laboratory** .5 Unit
Degree Applicable, CSU

Corequisite: CISS 23

Hands-on labs to troubleshoot and monitor network. Detect and block network attack with IPS. Student must take CISS 23 concurrently.

41122 Th 8:45pm - 10:10pm Rubio, J 78-2155

■ **CISS 25 — Network Security and Firewalls** 3.0 Units
Degree Applicable, CSU

Corequisite: CISS 25L

Advisory: (CISN 11 and CISN 11L) or (CISN 24 and CISN 24L) or (CISN 51 and CISN 51L)

Design, configure, and implement firewalls to secure networks. Student must enroll in CISS 25L concurrently.

44173 W 7:00pm - 8:30pm Rubio, J 78-2155
and arrange 1.62 hours Rubio, J ONLINE

NOTE:CRN 44173 is a Hybrid Class taught partially online with scheduled meetings on campus.

How to Begin Course: Log into Canvas through the eLearning Tools tab in the Mt. SAC portal at my.mtsac.edu. Then click on the Canvas link and then click on CRN for your DL course. **NOTE:** Some courses may not be activated until the start of the term. If you cannot locate your DL course in Canvas when the term starts, contact the professor. **On the first day of classes, log into your DL course to show your "attendance" because not doing so could result in your being dropped from the class for non-attendance.**

Contact info: Email Professor Rubio at either: jesus.rubio@mtsac.edu, through Student Detail Schedule or Canvas at MyMtSAC Portal.

Students must use their Mt. SAC e-mail account and be aware of course commitment and student expectations described at <http://www.mtsac.edu/instruction/learning/distlearn/>

To prepare for a successful online learning experience, see helpful short videos <http://www.mtsac.edu/distancelearning/quiz/>

■ **CISS 25L — Network Security and Firewalls Laboratory** .5 Unit
Degree Applicable, CSU

Corequisite: CISS 25

Laboratory for CISS 25 Network Security and Firewalls. Students must enroll in CISS 25 concurrently.

41124 W 8:45pm - 10:10pm Rubio, J 78-2155

■ **CISS 27 — Cyber Defense** 1.0 Unit
Degree Applicable

Advisories: CISN 11 and CISN 11L

Hands-on defending and analyzing cyber-attacks. Secure computer, network, smart devices, and application services.

44253 S 1:00pm - 4:10pm Chiu, P 78-2135

■ **CISS 29 — CNASM Service Learning** 1.0 Unit
Degree Applicable, CSU

(May be taken for option of Letter grade or Pass/NoPass)

Explore career objectives and advanced skills from CNASM courses through lab activities and community services.

41243 S 9:00am - 12:10pm Lin, J 78-2135

**COMPUTER INFORMATION SYSTEMS:
WEB APPLICATIONS**

■ **CISW 15 — Web Site Development** 3.5 Units
Degree Applicable, CSU

Advisory: CISB 15 or CISB 16

Plan, develop, implement, publish, and maintain Web sites with a professional visual Web-authoring application.

41126 T 7:00pm - 8:25pm Blyzka, J 78-2100
and T 8:35pm - 10:10pm Blyzka, J 78-2100
and arrange 1.7 hours Blyzka, J ONLINE

■ **CISW 17 — HTML, CSS and JavaScript Programming** 3.0 Units
Degree Applicable, CSU

Advisory: CISB 11

Plan, program, implement, publish and maintain web sites using HTML5, CSS3, and JavaScript.

41202 W 7:00pm - 10:10pm Zamora, V 78-2140

■ **CISW 21 — Secure Web Programming with ASP.NET** 3.0 Units
Degree Applicable, CSU

Corequisite: CISW 21L

Advisory: CISB 15

Secure Web programming using XML, XHTML, DHTML, Javascript, AJAX, and ASP.NET with VB.NET. Students must take CISW 21L concurrently.

44069 Th 7:00pm - 8:30pm Blyzka, J 78-2140
and arrange 1.7 hours Blyzka, J ONLINE

NOTE:CRN 44069 is a Hybrid Class taught partially online with scheduled meetings on campus.

How to Begin Course: Log into Canvas through the eLearning Tools tab in the Mt. SAC portal at my.mtsac.edu. Then click on the Canvas link and then click on CRN for your DL course. **NOTE:** Some courses may not be activated until the start of the term. If you cannot locate your DL course in Canvas when the term starts, contact the professor. **On the first day of classes, log into your DL course to show your "attendance" because not doing so could result in your being dropped from the class for non-attendance.**

Contact info: Email Professor Blyzka at either: jbyzka@mtsac.edu, through Student Detail Schedule or Canvas at MyMtSAC Portal.

Students must use their Mt. SAC e-mail account and be aware of course commitment and student expectations described at <http://www.mtsac.edu/instruction/learning/distlearn/>

To prepare for a successful online learning experience, see helpful short videos <http://www.mtsac.edu/distancelearning/quiz/>

■ **CISW 21L — Secure Web Programming with ASP.NET Laboratory** .5 Unit
Degree Applicable, CSU

Corequisite: CISW 21

Secure Web programming lab using XHTML, DHTML, XML, Javascript, AJAX, ASP.NET w/VB.NET. Student must take CISW 21 concurrently

44072 Th 8:40pm - 10:10pm Blyzka, J 78-2140

■ **CISW 31 — Secure Web Servers** 3.0 Units
Degree Applicable

Corequisite: CISW 31L

Advisory: (CISN 34 and CISN 34L) or (CISW 24 and CISW 24L)

Plan, install and manage secure Apache Web servers. Student must take CISW 31L concurrently.

41127 T 1:15pm - 2:40pm Zamora, V 78-2140
and arrange 1.6 hours Zamora, V ONLINE

NOTE:CRN 41127 is a Hybrid Class taught partially online with scheduled meetings on campus.

How to Begin Course: Log into Canvas through the eLearning Tools tab in the Mt. SAC portal at my.mtsac.edu. Then click on the Canvas link and then click on CRN for your DL course. **NOTE:** Some courses may not be activated until the start of the term. If you cannot locate your DL course in Canvas when the term starts, contact the professor. **On the first day of classes, log into your DL course to show your "attendance" because not doing so could result in your being dropped from the class for non-attendance.**

Contact info: Email Professor Zamora at either: vzamora@mtsac.edu, through Student Detail Schedule or Canvas at MyMtSAC Portal.

Students must use their Mt. SAC e-mail account and be aware of course commitment and student expectations described at <http://www.mtsac.edu/instruction/learning/distlearn/>

To prepare for a successful online learning experience, see helpful short videos <http://www.mtsac.edu/distancelearning/quiz/>

■ CISW 31L — Secure Web Servers Laboratory .5 Unit Degree Applicable

Corequisite: CISW 31

Linux, Apache Web server, MySQL and PHP. Students must take CISW 31 concurrently.

41128 T 2:50pm - 4:15pm Zamora, V 78-2140

COMPUTER SCIENCE

■ CSCI 110 — Fundamentals of Computer Science 3.5 Units Degree Applicable, CSU, UC

Prerequisite: MATH 71 or MATH 71B or MATH71X

Advisory: Eligibility for ENGL 1A

Concepts of computer hardware/software and an introduction to programming using a high level language.

42176	F	8:00am - 11:10am	Chen, D	61-1418
and	F	11:20am - 12:35pm	Chen, D	61-1418
42177	MW	11:15am - 12:35pm	Pop, H	61-1418
and	MW	12:45pm - 1:35pm	Pop, H	61-1418
42269	TTh	11:15am - 12:35pm	Chen, D	61-1418
and	TTh	12:45pm - 1:35pm	Chen, D	61-1418
43581	MW	7:00pm - 8:20pm	Dos Reis, A	61-1418
and	MW	8:30pm - 9:20pm	Dos Reis, A	61-1418

■ CSCI 140 — C++ Language and Object Development 4.0 Units (C-ID COMP 122) Degree Applicable, CSU, UC

Prerequisite: CSCI 110

C++ and object-oriented programming for computer science and other science students.

42178	MW	8:00am - 9:25am	Pop, H	61-1418
and	MW	9:45am - 11:10am	Pop, H	61-1418
42242	TTh	1:45pm - 3:10pm	Pop, H	61-1418
and	TTh	3:30pm - 4:55pm	Pop, H	61-1418

■ CSCI 145 — Java Language and Object Oriented Programming 4.0 Units Degree Applicable, CSU, UC

Prerequisite: CSCI 110

Java and object-oriented programming for computer science and other science students.

42179	TTh	8:00am - 9:25am	Vo, T	61-1418
and	TTh	9:45am - 11:10am	Vo, T	61-1418
43582	TTh	7:15pm - 8:35pm	Young, G	61-1418
and	TTh	8:45pm - 10:10pm	Young, G	61-1418

■ CSCI 150 — Assembly Language/Machine Architecture 3.5 Units Degree Applicable, CSU, UC

Prerequisite: CSCI 110

Advisory: CSCI 140 or CSCI 145

Organization and operation of computer systems and assembly language programming.

42180	MW	4:10pm - 5:30pm	Vo, T	61-1418
and	MW	5:40pm - 6:30pm	Vo, T	61-1418

■ CSCI 190 — Discrete Mathematics Applied to Computer Science 4.0 Units Degree Applicable, CSU, UC

Prerequisite: MATH 71 or equivalent

Mathematics for computer science such as logic, proof techniques, sets, recursions, trees, and graphs.

42229	MW	9:45am - 11:50am	Childress, S	61-2414
-------	----	------------------	--------------	---------

■ CSCI 230 — Data Structures II 3.5 Units Degree Applicable, CSU, UC

Prerequisite: CSCI 220

Searching, sorting, hash tables, and graphs. Memory and disk management techniques.

43583	F	9:45am - 12:50pm	Vo, T	61-1420
and	F	1:00pm - 2:20pm	Vo, T	61-1418
42181	MW	1:40pm - 3:00pm	Vo, T	61-1418
and	MW	3:10pm - 4:00pm	Vo, T	61-1418

COMPUTER AND NETWORKING TECHNOLOGY

■ CNET 50 — PC Servicing 4.0 Units Degree Applicable

Advisory: ELEC 50A and ELEC 50B taken prior or concurrently

PC and peripheral servicing techniques, preventative maintenance, hardware and software configurations, and diagnostics.

41351	M	8:00am - 11:10am	Miller, K	28B-401
and	M	11:30am - 2:40pm	Miller, K	28B-401
41352	M	6:30pm - 9:40pm	Hauchwitz, M	28B-404
and	W	6:30pm - 9:40pm	Yee, H	28B-401

■ CNET 56 — Computer Networks 4.0 Units Degree Applicable

Advisory: CNET 54 taken prior

Standards, terminology, design, implementation, and troubleshooting of local and wide area networks (hardware and software).

41353	W	8:00am - 11:10am	Miller, K	28B-404
and	W	11:30am - 2:40pm	Miller, K	28B-404

■ CNET 58 — Server Systems 4.0 Units Degree Applicable

Advisory: CNET 56

Physical and virtual server systems. Includes software and hardware components. Emphasis on hardware. Server+Certification material

41496	Th	8:00am - 11:10am	Miller, K	28B-405
and	Th	11:30am - 2:40pm	Miller, K	28B-405

COUNSELING

■ COUN 1 — Introduction to College 1.0 Unit Degree Applicable, CSU, UC

(May be taken for Pass/No Pass Only)

Higher education and the college experience including educational decision-making and educational planning.

44233	M	2:15pm - 4:20pm	Gutierrez, D	12-1020
8 Weeks, Week beginning 02/26/2018 ending 04/22/2018				
44376	T	2:15pm - 4:20pm	Cuevas-Arella, A	12-1020
8 Weeks, Week beginning 02/26/2018 ending 04/22/2018				
44231	Th	2:15pm - 4:20pm	Santacruz, R	12-1020
8 Weeks, Week beginning 02/26/2018 ending 04/22/2018				
44232	W	4:30pm - 6:35pm	Mestas, S	12-1020
8 Weeks, Week beginning 02/26/2018 ending 04/22/2018				

■ COUN 2 — College Success Strategies 3.0 Units Degree Applicable, CSU, UC

(May be taken for option of Letter grade or Pass/NoPass)

Strategies and techniques to be an effective college student and achieve educational and career goals.

44290	MW	8:00am - 9:25am	Hart, J	12-1020
-------	----	-----------------	---------	---------

NOTE: CRN 44290 above is designed for students in the Bridge Program.

Attendance at an information session and special approval are needed to enroll in this learning community. This course is linked to ENGL 67 (CRN 42697) and ENGL 68 (CRN 42729). For more information, please contact (909)274-5392.

44234	MW	9:45am - 11:10am	Hart, J	12-1020
44291	TTh	9:45am - 11:10am	Hart, J	12-1060

NOTE: CRN 44291 above is designed for students in the Bridge Program.

Attendance at an information session and special approval are needed to enroll in this learning community. This course is linked to MATH 50 (CRN 42032) and MATH 51 (CRN 42052). For more information, please contact (909)274-5392.

44235	MW	10:15am - 11:40am	Casas, D	211-1
44236	TTh	10:15am - 11:40am	Santacruz, R	40-129

■ **COUN 5 — Career and Life Planning****3.0 Units**

Degree Applicable, CSU

*Prerequisite: Eligibility for ENGL 68**Advisory: Eligibility for AMLA 33R or Eligibility for READ 90*

Explore and evaluate career options using a systematic approach to self-exploration, career, and life planning.

44411 MW 8:00am - 9:25am Torres, A 211-1

NOTE: CRN 44411 above is designed for students in the Bridge Program. Attendance at an information session and special approval are needed to enroll in this learning community. This course is linked to MATH 51 (CRN 42047) and MATH 71 (CRN 42075). For more information, please contact (909)274-5392.

44293 TTh 9:45am - 11:10am Ton, C 12-1080

NOTE: CRN 44293 above is designed for students in the Bridge Program. Attendance at an information session and special approval are needed to enroll in this learning community. This course is linked to ENGL 1A (CRN 42641). For more information, please contact (909)274-5392.

44360 TTh 9:45am - 11:10am Espinoza, L TBA

NOTE: CRN 44360 above is designed for students in the Bridge Program. Attendance at an information session and special approval are needed to enroll in this learning community. This course is linked to ENGL 1A (CRN 42640). For more information, please contact (909)274-5392.

44377 TTh 9:45am - 11:10am Flameno, B 211-1

NOTE: CRN 44377 above is designed for students in the Bridge Program. Attendance at an information session and special approval are needed to enroll in this learning community. This course is linked to ENGL 1A (CRN 42650). For more information, please contact (909)274-5392.

44237 TTh 10:15am - 11:40am Lee, E 12-1020

44292 TTh 11:30am - 12:55pm Perez, A 12-1080

NOTE: CRN 44292 above is designed for students in the Bridge Program. Attendance at an information session and special approval are needed to enroll in this learning community. This course is linked to ENGL 1A (CRN 42667). For more information, please contact (909)274-5392.

44362 TTh 11:30am - 12:55pm Espinoza, L TBA

NOTE: CRN 44362 above is designed for students in the Bridge Program. Attendance at an information session and special approval are needed to enroll in this learning community. This course is linked to ENGL 1A (CRN 42648). For more information, please contact (909)274-5392.

44239 Th 11:30am - 2:40pm Nakamatsu, S 12-1060

44363 TTh 1:15pm - 2:40pm Espinoza, L TBA

NOTE: CRN 44363 above is designed for students in the Bridge Program. Attendance at an information session and special approval are needed to enroll in this learning community. This course is linked to MATH 71 (CRN 42081). For more information, please contact (909)274-5392.

44238 T 3:00pm - 6:10pm Poulter, S 21A-1

44294 Th 3:00pm - 6:10pm Lopez, J 12-1060

NOTE: CRN 44294 above is designed for students in the Dream Program. Attendance at an information session and special approval are needed to enroll in this learning community. This course is linked to English 1A (CRN 43040). For information, please contact the Dream Program at (909) 274-5596.

44240 M 02/26 7:00pm - 10:10pm Mbuthi, S 12-1060
and arrange 6.75 hours Mbuthi, S ONLINE
8 Weeks, Week beginning 02/26/2018 ending 04/22/2018

NOTE: CRN 44240 is a Hybrid Class taught partially online with a Mandatory Scheduled Meeting on campus.

Course orientation scheduled above is mandatory. If student cannot attend orientation, student must contact professor before orientation meeting to avoid being dropped from class.

How to Begin Course: Log into Canvas through <http://myportal.mtsac.edu> and click on CRN for your DL course. **NOTE:** Some courses may not be activated until the start of the term. If you cannot locate your DL course in Canvas when the term starts, contact the professor. On the first day of class, log into your DL course to show your "attendance" because not doing so could result in you being dropped from the class for non-attendance.

Professor contact info: Email Professor Mbuthi at either: smbuthi@mtsac.edu, through Student Detail Schedule or Canvas at MyMtSAC Portal.

Students must use their Mt. SAC e-mail account and be aware of course commitment and student expectations described at <http://www.mtsac.edu/instruction/distlearn/>

To prepare for a successful online learning experience, see helpful short videos <http://www.mtsac.edu/distancelearning/quiz/>.

Modern computer with internet connection required.

44241 TW 7:00pm - 9:05pm Mbuthi, S 12-1060
and arrange 2.66 hours Mbuthi, S ONLINE
8 Weeks, Week beginning 02/26/2018 ending 04/22/2018

NOTE: CRN 44241 is a Hybrid Class taught partially online with Mandatory Scheduled Meetings on campus.

How to Begin Course: Log into Canvas through <http://myportal.mtsac.edu> and click on CRN for your DL course. **NOTE:** Some courses may not be activated until the start of the term. If you cannot locate your DL course in Canvas when the term starts, contact the professor. On the first day of class, log into your DL course to show your "attendance" because not doing so could result in you being dropped from the class for non-attendance.

Professor contact info: Email Professor Mbuthi at either: smbuthi@mtsac.edu, through Student Detail Schedule or Canvas at MyMtSAC Portal.

Students must use their Mt. SAC e-mail account and be aware of course commitment and student expectations described at <http://www.mtsac.edu/instruction/distlearn/>

To prepare for a successful online learning experience, see helpful short videos <http://www.mtsac.edu/distancelearning/quiz/>.

Modern computer with internet connection required.

■ **COUN 7 — Introduction to the Transfer Process****2.0 Units**

Degree Applicable, CSU

(May be taken for option of Letter grade or Pass/NoPass)

Advisory: Eligibility for ENGL 1A

Exploration of transfer requirements, admission procedures, and requirements for majors. Field trips are required.

44244 W 9:00am - 11:05am Thomas, A 12-1060

44406 TTh 10:00am - 11:05am Barrios, M 21A-1

NOTE: CRN 44406 above is designed for students in the Bridge Program. Attendance at an information session and special approval are needed to enroll in this learning community. This course is linked to MATH 130 (CRN 42129). For more information, please contact (909)274-5392.

DANCE: ACTIVITY■ **DNCE 2A — Ballet I****1.0 Unit**

Degree Applicable, CSU, UC

(May be taken for option of Letter grade or Pass/NoPass)

Beginning vocabulary, technique, and movement combinations for ballet.

44773 MW 11:30am - 12:55pm Lee, F 2-T122

NOTE: CRN 44773: No-cost digital textbooks or textual materials used.

Don't Waste Your Time or Money

- Take the right classes
- ➔ Figure out your career path
- Earn transferable units

REGISTER FOR:

Coun1 - Introduction to College • Coun2 - College Success Strategies
Coun5 - Career/Life Planning • Coun7 - Introduction to the Transfer Process
Lead 55- Exploring Leadership • Coun 51-Career Planning

www.mtsac.edu/counseling/courses.html

■ DNCE 2B — Ballet II

1.0 Unit

Degree Applicable, CSU, UC

(May be taken four times for credit)

(May be taken for option of Letter grade or Pass/NoPass)

Intermediate technique, vocabulary, and movement combinations of ballet.

43115 MW 1:15pm - 2:40pm Nakamura, A 2-T122

NOTE: CRN 43115: No-cost digital textbooks or textual materials used.

■ DNCE 8 — Latin Dance I

.5 Unit

Degree Applicable, CSU, UC

(May be taken for option of Letter grade or Pass/NoPass)

Latin styles of dance. Includes Cha Cha, Samba, Rumba, Pasodoble, Jive.

43275 T 3:00pm - 5:05pm Hendrix, J 45-1411

NOTE: CRN 43275: No-cost digital textbooks or textual materials used.

■ DNCE 11A — Social Dance Forms I

1.0 Unit

Degree Applicable, CSU, UC

(May be taken for option of Letter grade or Pass/NoPass)

Dance positions, steps, formations, and choreography of social dance techniques.

43116 MW 1:15pm - 2:40pm Lefler, P 2-T121

NOTE: CRN 43116: is male section. No-cost digital textbooks or textual materials used.

43117 MW 1:15pm - 2:40pm Lefler, P 2-T121

NOTE: CRN 43117: is female section. No-cost digital textbooks or textual materials used.

43118 TTh 5:15pm - 6:40pm Hendrix, J 2-T121

NOTE: CRN 43118: No-cost digital textbooks or textual materials used.

■ DNCE 11B — Social Dance Forms II

1.0 Unit

Degree Applicable, CSU, UC

(May be taken for option of Letter grade or Pass/NoPass)

Advanced dance positions, formations, music and choreography of social dance techniques.

43119 MW 1:15pm - 2:40pm Lefler, P 2-T121

NOTE: CRN 43119: No-cost digital textbooks or textual materials used.

43177 TTh 5:15pm - 6:40pm Hendrix, J 2-T121

NOTE: CRN 43177: No-cost digital textbooks or textual materials used.

■ DNCE 12A — Modern I

1.0 Unit

Degree Applicable, CSU, UC

(May be taken for option of Letter grade or Pass/NoPass)

Beginning terminology, technique, and movement combinations for Modern dance.

44378 MW 11:30am - 12:55pm Lefler, P 2-T121

NOTE: CRN 44378: No-cost digital textbooks or textual materials used.

■ DNCE 12B — Modern II

1.0 Unit

Degree Applicable, CSU, UC

(May be taken for option of Letter grade or Pass/NoPass)

Intermediate terminology, technique, and movement combinations for Modern dance.

43967 MW 3:00pm - 4:25pm Estrada-Romero, J 2-T121

NOTE: CRN 43967: No-cost digital textbooks or textual materials used.

43128 TTh 4:45pm - 6:10pm Shear, M 2-T122

NOTE: CRN 43128: No-cost digital textbooks or textual materials used.

■ DNCE 13 — Modern Performance

1.0 Unit

Degree Applicable, CSU, UC

(May be taken four times for credit)

(May be taken for option of Letter grade or Pass/NoPass)

Performance aspects of Modern dance for the experienced dance student.

43307 TTh 4:45pm - 6:10pm Shear, M 2-T122

NOTE: CRN: 43307 No-cost digital textbooks or textual materials used.

■ DNCE 14A — Jazz I

1.0 Unit

Degree Applicable, CSU, UC

(May be taken for option of Letter grade or Pass/NoPass)

Beginning vocabulary, technique, and movement combinations for jazz dance.

43122 MW 9:45am - 11:10am Lefler, P 2-T121

NOTE: CRN 43122: No-cost digital textbooks or textual materials used.

<p>■ DNCE 14B — Jazz II 1.0 Unit Degree Applicable, CSU, UC (May be taken for option of Letter grade or Pass/NoPass) Intermediate vocabulary, technique, and movement combinations for jazz dance. 44126 TTh 9:45am - 11:10am Martino, L 2-T121 NOTE: CRN 44126: No-cost digital textbooks or textual materials used.</p>	<p>■ DNCE 32 — Commercial Dance 1.0 Unit Degree Applicable, CSU, UC (May be taken for option of Letter grade or Pass/NoPass) Beginning terminology, styles, and choreography of Hip Hop dance. 43123 MW 4:45pm - 6:10pm Jones, M 2-T121 NOTE: CRN 43123: No-cost digital textbooks or textual materials used. 43124 MW 6:30pm - 7:55pm Jones, M 2-T121 NOTE: CRN 43124: No-cost digital textbooks or textual materials used.</p>
<p>■ DNCE 15 — Jazz Performance 1.0 Unit Degree Applicable, CSU, UC (May be taken for option of Letter grade or Pass/NoPass) Introduces the experienced dancer to performance styles and techniques of jazz dance. 43308 TTh 9:45am - 11:10am Martino, L 2-T121 NOTE: CRN 43308: No-cost digital textbooks or textual materials used.</p>	<p>■ DNCE 36 — Commercial Dance II 1.0 Unit Degree Applicable, CSU, UC (May be taken for option of Letter grade or Pass/NoPass) Styles and choreography of Hip Hop dance. 43270 MW 4:45pm - 6:10pm Jones, M 2-T121 NOTE: CRN 43270: No-cost digital textbooks or textual materials used. 43271 MW 6:30pm - 7:55pm Jones, M 2-T121 NOTE: CRN 43271: No-cost digital textbooks or textual materials used.</p>
<p>■ DNCE 18A — Tap I 1.0 Unit Degree Applicable, CSU, UC (May be taken for option of Letter grade or Pass/NoPass) Beginning level technique, rhythms and routines for tap dance. 43125 TTh 1:15pm - 2:40pm Hendrix, J 45-1411 NOTE: CRN 43125: No-cost digital textbooks or textual materials used.</p>	<p>■ DNCE 39A — Alignment and Correctives I .5 Unit Degree Applicable, CSU, UC (May be taken for option of Letter grade or Pass/NoPass) Pilates method of conditioning (mat and Reformer). 43173 Th 3:00pm - 5:05pm Ritz, K 45-1411 NOTE: CRN 43173: No-cost digital textbooks or textual materials used.</p>
<p>■ DNCE 18B — Tap II 1.0 Unit Degree Applicable, CSU, UC (May be taken for option of Letter grade or Pass/NoPass) Intermediate technique, rhythms, and routines for tap dance. 43965 TTh 1:15pm - 2:40pm Hendrix, J 45-1411 NOTE: CRN 43965: No-cost digital textbooks or textual materials used.</p>	<p>■ DNCE 40 — Conditioning Through Dance 1.0 Unit Degree Applicable, CSU, UC (May be taken for option of Letter grade or Pass/NoPass) Improves fitness through the coordination of dance exercises. Focuses on strength, flexibility, and range of motion. 44142 MW 8:00am - 9:25am Lefler, P 2-T122 NOTE: CRN 44142: No-cost digital textbooks or textual materials used. 43174 TTh 5:15pm - 6:40pm Ritz, K 45-1411 NOTE: CRN 43174: No-cost digital textbooks or textual materials used.</p>
<p>■ DNCE 22 — Dance Rehearsal 1.0 Unit Degree Applicable, CSU, UC (May be taken for option of Letter grade or Pass/NoPass) Designed for the experienced dancer to work in rehearsal environment and participate in elements of concert production. 43972 T 11:30am - 2:40pm Martino, L 2-T121 NOTE: CRN 43972: No-cost digital textbooks or textual materials used. 43974 Th 6:30pm - 9:40pm Shear, M 2-T122 NOTE: CRN 43974: No-cost digital textbooks or textual materials used.</p>	<p>■ DNCE 41 — Pilates I 1.0 Unit Degree Applicable, CSU, UC (May be taken for option of Letter grade or Pass/NoPass) <i>Advisory: DNCE 39A</i> Pilates beginning and intermediate Mat and beginning Reformer. Includes Pilatesstick, Magic Circle. 43187 MW 11:30am - 12:55pm Ritz, K 45-1411 NOTE: CRN 43187: No-cost digital textbooks or textual materials used. 43188 TTh 7:00pm - 8:25pm Ritz, K 45-1411 NOTE: CRN 43188: No-cost digital textbooks or textual materials used.</p>
<p>■ DNCE 24 — Dance Production 2.0 Units Degree Applicable, CSU, UC (May be taken for option of Letter grade or Pass/NoPass) Designed for the experienced dancer to apply choreographic skills, conduct stage rehearsals and learn costuming techniques. 43988 TTh 11:30am - 2:40pm Martino, L 2-T121 NOTE: CRN 43988: No-cost digital textbooks or textual materials used. 44008 TTh 6:30pm - 9:40pm Shear, M 2-T122 NOTE: CRN 44008: No-cost digital textbooks or textual materials used.</p>	<p>■ DNCE 42 — Pilates II 1.0 Unit Degree Applicable, CSU, UC (May be taken for option of Letter grade or Pass/NoPass) <i>Advisory: DNCE 41</i> Pilates intermediate mat, Reformer, Pilatesstick. Beginning Chair, Step Barrel, Ped-a-Pul. 43189 MW 4:45pm - 6:10pm Ritz, K 45-1411 NOTE: CRN 43189: No-cost digital textbooks or textual materials used.</p>
<p>■ DNCE 30 — Contemporary Dance 1.0 Unit Degree Applicable, CSU, UC (May be taken for option of Letter grade or Pass/NoPass) <i>Advisories: DNCE12B and DNCE 13</i> Intermediate to advanced terminology, technique, and movement combinations for Contemporary Dance. 44013 MW 3:00pm - 4:25pm Estrada-Romero, J 2-T121 NOTE: CRN 44013: No-cost digital textbooks or textual materials used.</p>	<p>■ DNCE 43 — Pilates III 1.0 Unit Degree Applicable, CSU, UC <i>Prerequisite: DNCE 42</i> Pilates intermediate and advanced mat, Reformer, Wunda Chair, Pilatesstick. Use of Cadillac and High Barrel. 43310 MW 4:45pm - 6:10pm Ritz, K 45-1411 NOTE: CRN 43310: No-cost digital textbooks or textual materials used.</p>
<p>■ DNCE 31 — Classical Dance 1.0 Unit Degree Applicable, CSU, UC (May be taken for option of Letter grade or Pass/NoPass) Advanced ballet repertoire focusing on the different schools of technique including Balanchine, Bournonville, and Vaganova. 44021 MW 1:15pm - 2:40pm Nakamura, A 2-T122 NOTE: CRN 44021: No-cost digital textbooks or textual materials used.</p>	

DANCE: THEORY

■ DN-T 20 — History and Appreciation of Dance **3.0 Units**
Degree Applicable, CSU, UC

Advisory: Eligibility for ENGL 68

Survey of theatrical dance in western civilization.

43193	MW	8:00am - 9:25am	Shear, M	TBA
43127	F	8:00am - 11:10am	Nakamura, A	2-T120
43272	MW	9:45am - 11:10am	Nakamura, A	TBA
43126	MW	11:30am - 12:55pm	Nakamura, A	TBA

■ DN-T 27 — Theory and Principles of Pilates **3.0 Units**
Degree Applicable

Corequisite: DNCE 39A (may have been taken previously)

Teaching skills for the Pilates method of physical and mental conditioning.

44145	M	6:30pm - 9:40pm	Ritz, K	45-1411
-------	---	-----------------	---------	---------

■ DN-T 29 — Teaching Pilates Mat Repertoire **1.5 Units**
Degree Applicable

Corequisite: DN-T 27 (may have been taken previously)

Learning to teach the Pilates mat exercises and principles.

44144	W	6:30pm - 9:40pm	Ritz, K	45-1411
-------	---	-----------------	---------	---------

■ DN-T 38 — Dance Teaching Methods **3.0 Units**
Degree Applicable

Corequisite: DNCE 2B or DNCE 12B or DNCE 14B

The application of pedagogical methods in dance. Course will involve on- and off-campus teaching observations.

43190	TTh	1:30pm - 4:00pm	Shear, M	2-T122
-------	-----	-----------------	----------	--------

DISABLED STUDENTS

■ DSPS 33 — Strategies for Success in Math for Students with Disabilities **3.0 Units**
Not Degree Applicable

(May be taken for Pass/No Pass Only)

Advisory: Concurrent enrollment in MATH 50 to MATH 130

Strategies for students with disabilities who are currently in math courses.

43694	MW	9:45am - 11:10am	Lee, B	9E-2080
43695	TTh	11:30am - 12:55pm	Lee, B	9E-2080

■ DSPS 34 — Writing Strategies **3.0 Units**
Not Degree Applicable

(May be taken for Pass/No Pass Only)

Prerequisite: Eligibility for ENGL 67

Strategies for success for students who struggle with writing concurrently enrolled in ENGL 67-1C classes.

43696	MW	11:30am - 12:55pm	Lee, B	9E-1060
-------	----	-------------------	--------	---------

EDUCATION

■ EDUC 10 — Introduction to Education **3.0 Units**
Degree Applicable, CSU, UC

Prerequisite: Eligibility for ENGL 68

Concepts and issues related to teaching diverse learners. 45 hrs of K-12 classroom observations, TB and fingerprint tests required.

41170	Th	3:00pm - 6:10pm	Guerrero, B	73-1860
41171	M	6:30pm - 9:40pm	Hughey, D	73-1840

■ EDUC 16 — Aspects and Issues in Teaching **3.0 Units**
Degree Applicable, CSU, UC

Advisory: Eligibility for ENGL 68

Survey of the teaching profession. Off-site assignments may be required.

41172	Th	6:30pm - 9:40pm	Guerrero, B	73-1860
-------	----	-----------------	-------------	---------

ELECTRONICS

■ ELEC 11 — Technical Applications in Microcomputers **3.0 Units**
Degree Applicable, CSU

Personal computer (PC) applications used in electronics technology,

44124	T	8:00am - 10:05am	Uranga, J	28B-312
	and T	10:15am - 1:20pm	Uranga, J	28B-312
41354	MW	6:00pm - 7:10pm	Uranga, J	28B-312
	and MW	7:20pm - 8:35pm	Uranga, J	28B-312

■ ELEC 12 — Computer Simulation and Troubleshooting **2.0 Units**
Degree Applicable

Advisory: ELEC 51 and ELEC 56 taken prior

Simulation and troubleshooting of electronic circuits with National Instruments Multisim software.

41355	M	5:00pm - 6:05pm	Denny, J	28B-312
	and M	6:10pm - 9:15pm	Denny, J	28B-312

■ ELEC 50A — Electronic Circuits - Direct Current (DC) **4.0 Units**
Degree Applicable, CSU

Advisory: Eligibility for MATH 51

DC electrical circuits and their applications. Students seeking a survey course should take ELEC 10, rather than ELEC 50A or 50B.

41356	MW	8:00am - 11:10am	Denny, J	28B-405
	and MW	11:30am - 2:40pm	Denny, J	28B-405
8 Weeks, Week beginning 02/26/2018 ending 04/22/2018				
41357	TTh	8:00am - 11:10am	Hyer, J	28B-401
	and TTh	11:30am - 2:40pm	Hyer, J	28B-401
8 Weeks, Week beginning 02/26/2018 ending 04/22/2018				

■ ELEC 50B — Electronic Circuits (AC) **4.0 Units**
Degree Applicable, CSU

Advisory: ELEC 50A taken prior

Alternating Current (AC) electrical circuits and their applications.

41358	MW	8:00am - 11:10am	Denny, J	28B-405
	and MW	11:30am - 2:40pm	Denny, J	28B-405
8 Weeks, Week beginning 04/23/2018 ending 06/17/2018				
41359	TTh	8:00am - 11:10am	Hyer, J	28B-401
	and TTh	11:30am - 2:40pm	Hyer, J	28B-401
8 Weeks, Week beginning 04/23/2018 ending 06/17/2018				
41360	T	6:30pm - 9:40pm	Olague, J	28B-403
	and Th	6:30pm - 9:40pm	Olague, J	28B-403

■ ELEC 54B — Industrial Electronic Systems **3.0 Units**
Degree Applicable, CSU

Programmable logic controllers (PLCs) used for industrial processes and industrial automation applications.

41361	M	8:00am - 10:30am	Uranga, J	28B-412
	and M	10:40am - 1:10pm	Uranga, J	28B-412

■ ELEC 55 — Microwave Communications **4.0 Units**
Degree Applicable

Advisory: ELEC 50B taken prior

Microwave components and circuits with emphasis on transmission lines, antennas, and impedance matching.

41362	W	8:00am - 11:10am	Hyer, J	28B-410
	and W	11:30am - 2:40pm	Hyer, J	28B-410

■ ELEC 56 — Digital Electronics **4.0 Units**
Degree Applicable, CSU

Combinational and sequential logic circuits emphasizing number systems, gates, flip-flops, counters, and reduction techniques.

41363	T	8:00am - 11:10am	Harsany, S	28B-405
	and T	11:30am - 2:40pm	Harsany, S	28B-405

■ ELEC 61 — Electronic Assembly and Fabrication **3.0 Units**
Degree Applicable, CSU

Advisory: ELEC 50A and ELEC 50B

Electronics manufacturing/fabrication processes in PCB design and layout, BOM, part selection, schematics, soldering, and cabling.

41364	T	5:00pm - 7:25pm	Denny, J	28B-312
	and T	7:35pm - 10:10pm	Denny, J	28B-312

■ **ELEC 74 — Microcontroller Systems** **4.0 Units**
Degree Applicable, CSU

Advisory: ELEC 56

Microcontrollers, programming, programmable logic devices (PLDs), and interfacing with industry applications and troubleshooting.

41365 Th 8:00am - 11:10am Christ, J 28B-403
and Th 11:30am - 2:40pm Christ, J 28B-403

EMERGENCY MEDICAL SERVICE

■ **EMS 10 — Anatomy and Physiology for Paramedics** **3.0 Units**
Degree Applicable

Prerequisite: Admission to Paramedic Program and EMS 1 and EMS 2

Corequisite: EMS 20, EMS 30, EMS 40, EMS 50, and EMS 60

Gross anatomy and physiology of the human body, with applications to paramedic practices.

44726 MTWThF 8:00am - 11:50am Mah, D 28B
4 Weeks, Week beginning 02/26/2018 ending 03/18/2018

■ **EMS 20 — Emergency Cardiac Care for Paramedics** **1.5 Units**
Degree Applicable

Prerequisite: Admission to the Paramedic Program

Corequisite: EMS 10, EMS 30, EMS 40, EMS 50, and EMS 60 (courses may have been taken previously)

Certifies students in Pediatric Advanced Life Support and Advanced Cardiac Life Support.

44731 arrange 15.00 hours STAFF 28B-207
2 Weeks, Week beginning 06/04/2018 ending 06/17/2018

■ **EMS 30 — Pharmacology for Paramedics** **3.0 Units**
Degree Applicable

Prerequisite: Admission to the Paramedic Program

Corequisite: EMS 10, EMS 20, EMS 40, EMS 50, EMS 60

Paramedic drugs with emphasis on dosages, routes of administration, expected therapeutic outcomes and possible adverse reactions.

44727 MTWThF 12:50pm - 2:10pm Wilson, C 28B-207
and MTWThF 2:20pm - 4:30pm Wilson, C 28B-209
6 Weeks, Week beginning 02/26/2018 ending 04/01/2018

■ **EMS 40 — Cardiology for Paramedics** **3.0 Units**
Degree Applicable

Prerequisite: Admission to the Paramedic Program

Corequisite: EMS 10, EMS 20, EMS 30, EMS 50, and EMS 60

Normal, abnormal, and diseased heart, assessments, assessment tools, interpretation of dysrhythmias, and paramedic interventions.

44728 MTWThF 8:00am - 11:35am Wilson, C 28B
3 Weeks, Week beginning 03/19/2018 ending 04/08/2018

■ **EMS 50 — Paramedic Skills Competency** **5.0 Units**
Degree Applicable

Prerequisite: Admission to the Paramedic Program

Corequisite: EMS 10, EMS 20, EMS 30, EMS 40, EMS 60

Paramedic skills required for field operation as a paramedic and for licensing in competency-based exams.

44729 3.37 hours Mah, D
and arrange 6.75 hours Lopez, D

■ **EMS 60 — EMS Theory for Paramedics** **8.5 Units**
Degree Applicable

Prerequisite: Admission to the Paramedic Program

Corequisite: EMS 10, EMS 20, EMS 30, EMS 40, and EMS 50

Paramedic theories, principles and practices, assessment and treatment of pathologic processes, and mechanisms of injury.

44730 MTWThF 8:00am - 11:50am Mah, D TBA
4 Weeks, Week beginning 04/09/2018 ending 06/03/2018

■ **EMS 80 — Paramedic Field Externship** **9.0 Units**
Degree Applicable

(May be taken for Pass/No Pass Only)

Prerequisite: EMS 70 and successful completion of Los Angeles County accreditation exam

Application of paramedic theory and practices in a field setting with emphasis on assessment and utilization of skills.

44733 arrange 30.37 hours Lopez, D FIELD

EMERGENCY MEDICAL TECHNICIAN

■ **EMT 90 — Emergency Medical Technician** **7.0 Units**
Degree Applicable

Prerequisite: EMT 90-A High school graduation or equivalent and minimum of 18 years of age

Approved by the LA County EMS Agency. Earn EMT Course Completion Certificate to take National Registry Certifying Exam.

44732 TTh 8:00am - 10:35am Laicans, A 28B-206
and TTh 10:45am - 12:15pm Laicans, A 28B-201
and arrange 3.15 hours Laicans, A OCAM
41551 MW 10:00am - 12:50pm Yoshida-Mcmath, C 28B-206
and MW 1:00pm - 2:25pm Yoshida-Mcmath, C 28B-201
and arrange 3.45 hours Yoshida-Mcmath, C OCAM
41576 TTh 5:00pm - 7:35pm Rodriguez, W 28B-206
and TTh 7:45pm - 9:15pm Rodriguez, W 28B-201
and arrange 3.15 hours Rodriguez, W OCAM

ENGINEERING

■ **ENGR 1 — Introduction to Engineering** **2.0 Units**
Degree Applicable, CSU, UC

Professional requirements for engineers including academic, licensure, and engineering design projects. Field trips required.

41939 M 7:30am - 8:40am Robinson, C 11-2101
and M 8:50am - 11:40am Robinson, C 11-2101
41940 W 7:30am - 8:40am Ash, K 11-2101
and W 8:50am - 11:40am Ash, K 11-2101
42012 F 7:30am - 8:40am Anderson, D 11-2101
and F 8:50am - 11:40am Anderson, D 11-2101

■ **ENGR 6 — Introduction to Engineering Programming Concepts and Methodologies** **4.0 Units**
Degree Applicable, CSU, UC

Prerequisite: Math 160

Fundamentals of procedure-oriented programming, design, sensor interfacing, and numerical techniques for engineering students.

42003 TTh 12:00pm - 1:25pm Mason, M 11-2107
and TTh 1:45pm - 3:10pm Mason, M 11-2107

■ **ENGR 7 — Programming Applications for Engineers** **4.0 Units**
Degree Applicable, CSU, UC

Prerequisite: Math 180

Introduction to Engineering computation using MATLAB.

41964 MW 12:00pm - 1:25pm Mahmoud, E 11-2107
and MW 1:45pm - 3:10pm Mahmoud, E 11-2107

■ **ENGR 8 — Properties of Materials** **4.0 Units**
Degree Applicable, CSU, UC

Prerequisite: CHEM 40 or CHEM 50 and PHYS 4A or PHYS 2AG

Mechanical, electrical, magnetic, optical, and thermal properties of engineering materials.

42004 TTh 2:15pm - 4:20pm Mahmoud, E 11-2304

ENGR 18 — Introduction to Engineering Graphics **3.0 Units**

Degree Applicable, CSU

Fundamentals of engineering graphics and problem solving techniques.

41969	F	7:30am - 9:35am	Khan, M	11-2107
	and F	9:45am - 12:55pm	Khan, M	11-2107
41941	TTh	8:00am - 9:25am	Khan, M	11-2107
	and TTh	9:35am - 10:40am	Khan, M	11-2107

ENGR 24 — Engineering Graphics **4.0 Units**

Degree Applicable, CSU, UC

*Prerequisite: MATH 150 AND (ENGR 18 or eligibility for ENGR 24)**Advisory: CISB 15*

CAD for engineers; geometry, dimensioning and tolerance; 2D and 3D CAD skills for the design and representation of 3D objects.

41952	MW	5:15pm - 6:40pm	Mahmoud, E	11-2107
	and MW	6:45pm - 7:50pm	Mahmoud, E	11-2107
	and MW	8:15pm - 9:40pm	Mahmoud, E	11-2107

ENGR 40 — Statics **3.0 Units**

Degree Applicable, CSU, UC

Prerequisite: PHYS 4A and MATH 181

Vector approach to static equilibrium of rigid bodies, forces, couples in two and three-dimensional space.

41965	TTh	11:30am - 12:55pm	Afrasiabi, J	11-2101
42005	MW	11:50am - 1:15pm	Khan, M	11-2101
41942	TTh	5:15pm - 6:40pm	STAFF	11-2101

ENGR 41 — Dynamics **3.0 Units**

Degree Applicable, CSU, UC

Prerequisite: ENGR 40

Vector approach to classical mechanics.

41933	MW	1:25pm - 2:50pm	Anderson, D	11-2101
-------	----	-----------------	-------------	---------

ENGR 42 — Mechanics of Materials **4.0 Units**

Degree Applicable, CSU, UC

Prerequisite: ENGR 40

Mechanics of deformable bodies subjected to axial, torsional, shearing, and bending loads.

42006	TTh	3:00pm - 5:05pm	Tseng, T	11-2101
-------	-----	-----------------	----------	---------

ENGR 44 — Electrical Engineering **4.0 Units**

Degree Applicable, CSU, UC

Prerequisite: PHYS 4B

Circuit analysis. Kirchoff's Laws and Thevenin's Theorems; transient and steady state sinusoidal analysis; polyphase circuits.

41943	TTh	8:00am - 9:25am	Afrasiabi, J	11-2101
	and TTh	9:45am - 11:10am	Afrasiabi, J	11-2101

ENGR 50A — Robotics Team Project Development **2.0 Units**

Degree Applicable, CSU

(May be taken four times for credit)

Prerequisite: Instructor approval required for robotics competition team members

This course is for members of the Robotics Team. Instructor Approval required. Off-campus competition required.

41966	F	12:00pm - 4:20pm	Anderson, D	11-2304
	and arrange	2.3 hours	STAFF	11-2304

ENGR 99 — Special Projects in Engineering **1.0 Unit**

Not Degree Applicable

Corequisite: PHYS 1 or PHYS 2AG or PHYS 4A (May have been taken previously)

Special projects in engineering. Student must have instructor's authorization before enrolling in the course.

41954	TTh	1:10pm - 2:30pm	STAFF	TBA
-------	-----	-----------------	-------	-----

ENGR 99 — Special Projects in Engineering **2.0 Units**

Not Degree Applicable

Corequisite: PHYS 1 or PHYS 2AG or PHYS 4A (May have been taken previously)

Special projects in engineering. Student must have instructor's authorization before enrolling in the course.

41953	MW	12:00pm - 1:15pm	STAFF	TBA
-------	----	------------------	-------	-----

ENGINEERING CONSTRUCTION TECH**ECT 67 — Reading Construction Drawings** **3.0 Units**

Degree Applicable, CSU

Reading construction drawings as applied to architecture, construction, and interior design. Off-campus assignments may be required.

44379	T	7:00pm - 10:10pm	Beilstein, E	13-1245
-------	---	------------------	--------------	---------

ECT 71 — Construction Estimating **3.0 Units**

Degree Applicable, CSU

Construction estimating and bidding procedures using contract documents, construction drawings, and cost data.

44380	Th	7:00pm - 10:10pm	Beilstein, E	13-1245
-------	----	------------------	--------------	---------

ENGINEERING DESIGN TECHNOLOGY**EDT 89 — Engineering Design Technology** **1.0 Unit****Work Experience**

Degree Applicable

(May be taken for Pass/No Pass Only)

Prerequisite: Application approved by department faculty and compliance with Work Experience regulations as designated in the College Catalog

41582	arrange	4.69 hours	James, S	28B
-------	---------	------------	----------	-----

EDT 89 — Engineering Design Technology **2.0 Units****Work Experience**

Degree Applicable

(May be taken for Pass/No Pass Only)

Prerequisite: Application approved by department faculty and compliance with Work Experience regulations as designated in the College Catalog

41549	arrange	9.38 hours	James, S	28B
-------	---------	------------	----------	-----

ENGLISH: COMPOSITION

ENGLISH PLACEMENT

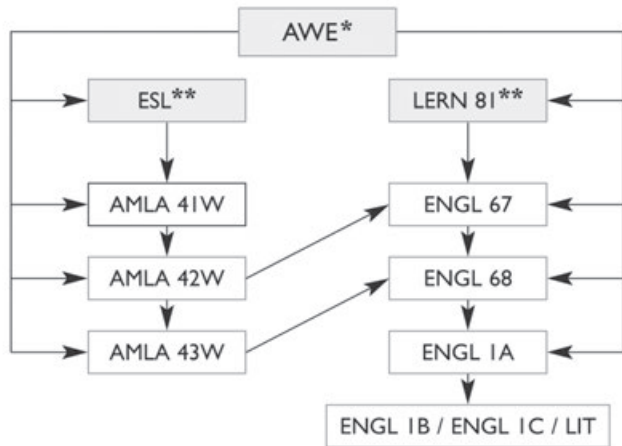

* Assessment of Written English Test — a test of your abilities in Language Usage. It is required for placement in English classes (including LERN, AMLA, and ESL classes), Business English classes, admission to the Health Science Program and all courses requiring English eligibility.

** Students may enroll in ESL (English as a Second Language) and LERN (for native speakers) without taking the AWE.

PLACEMENT IN ENGLISH COMPOSITION CLASSES

Students are placed in Composition classes as a result of appropriate scores on the Mt. SAC Assessment of Written English or equivalent prerequisite courses successfully completed ("C" or better) at other colleges that fulfill the Mt. SAC prerequisite for the respective course.

Students with appropriate scores will be placed in Freshman Composition 1A. Students needing additional developmental work will be placed in ENGL 68 (Preparation for College Writing) or in both ENGL 67 (Writing Fundamentals) and ENGL 68 (Preparation for College Writing) (NO CONCURRENT ENROLLMENT). Depending upon initial placement into English courses, students are eligible for Freshman Composition (ENGL 1A) upon successful completion of ENGL 67 (Writing Fundamentals) and ENGL 68 (Preparation for College Writing). Students are encouraged to complete Freshman Composition 1A as early in their college program as possible.

■ ENGL 1A — Freshman Composition 4.0 Units

(C-ID ENGL 100) Degree Applicable, CSU, UC
Prerequisite: ENGL 68 or satisfactory score on the English Placement Test
Develops expository and argumentative essay and research paper skills. Emphasizes critical reading of academic material.

42630 MTWTh 7:30am - 9:35am Hernandez, L 26A-3690
8 Weeks, Week beginning 02/26/2018 ending 04/22/2018

NOTE: CRN 42630 is linked to CRN 42902 and is a part of the Pathways Program. This course is continuing from the Winter term and seats are reserved for students already in the program. Any additional seats will be open for registration to any eligible student. This course is a part of English Cohort #8. If you have any questions please email pathways@mtsac.edu or call (909) 274-5703.

42659 MTWTh 7:30am - 9:35am Piluso, R 18-1
8 Weeks, Week beginning 02/26/2018 ending 04/22/2018

NOTE: CRN 42659 is linked to CRN 42675 and is a part of the Pathways Program. This course is continuing from the Winter term and seats are reserved for students already in the program. Any additional seats will be open for registration to any eligible student. This course is a part of English Cohort #7. If you have any questions please email pathways@mtsac.edu or call (909) 274-5703.

42789 MTWTh 7:30am - 9:35am Tolliver, T 26D-2210
8 Weeks, Week beginning 04/23/2018 ending 06/17/2018

NOTE: CRN 42789 is linked to CRN 42718 and is a part of the Pathways Program. This course is continuing from the Winter term and seats are reserved for students already in the program. Any additional seats will be open for registration to any eligible student. This course is a part of English Cohort #9. If you have any questions please email pathways@mtsac.edu or call (909) 274-5703.

42626 MW 7:30am - 9:35am Harper, M 26A-3881
42627 MW 7:30am - 9:35am Vance, D 26A-3620
42628 MW 7:30am - 9:35am STAFF 26A-3841
42629 MW 7:30am - 9:35am Estrada, M 26A-3871
42900 MW 7:30am - 9:35am Churchill, P 26D-3280
42901 T 7:30am - 9:35am Allende, K 26A-3680
and arrange 2.25 hours Allende, K ONLINE

NOTE: CRN 42901 is a Hybrid Class taught partially online with Scheduled Meetings on Campus.

How to Begin Course: Log into Canvas through <http://myportal.mtsac.edu> and click on CRN for your DL course. **NOTE:** Some courses may not be activated until the start of the term. If you cannot locate your DL course in Canvas when the term starts, contact the professor. **On the first day of classes, log into your DL course to show your "attendance" because not doing so could result in your being dropped from the class for non-attendance.**

Professor contact info: Email Professor Allende at either: KAllende@mtsac.edu, through Student Detail Schedule or Canvas at MyMtSAC Portal.

Students must use their Mt. SAC e-mail account and be aware of course commitment and student expectations described at <http://www.mtsac.edu/instruction/learning/distlearn/>

To prepare for a successful online learning experience, see helpful short videos at <http://www.mtsac.edu/distancelarning/quiz/>

42631 TTh 7:30am - 9:35am Weidner, N 21A-2

NOTE: This class is linked to ENGL 66 (CRN 43010) and is an option only for ENGL 68 eligible students who have not already passed ENGL 68. This option allows students to bypass ENGL 68 and enroll in ENGL 1A only while taking an ENGL 66 section as a co-requisite. Please contact the Humanities and Social Sciences Division at (909)274-4570 with any questions.

42632 TTh 7:30am - 9:35am Alvarez-Galvan, M 66-209
42633 TTh 7:30am - 9:35am Vance, D 26A-3620
42634 TTh 7:30am - 9:35am Lynch, C 26A-3670
42635 TTh 7:30am - 9:35am Lee, B 26A-3841
42636 F 9:00am - 1:15pm Gomez, F 26A-3670
42637 F 9:00am - 1:15pm Spradlin, S 26A-3831
42638 F 9:00am - 1:15pm Wright, S 26D-G220
42847 MTWTh 9:45am - 11:50am Piluso, R 18-1

8 Weeks, Week beginning 02/26/2018 ending 04/22/2018

42639 MW 9:45am - 11:50am Harper, M 26A-3881
42640 MW 9:45am - 11:50am Quintana-Mullane, K 26A-3690

NOTE: No cost digital textbooks or textual materials used. CRN 42640 above is designed for students in the Bridge Program. Attendance at an information session and special approval are needed to enroll in this learning community. This course is linked to COUN 5 (CRN 44360). For more information, please contact (909)274-5392.

42641 MW 9:45am - 11:50am Estrada, M 26A-3871

NOTE: CRN 42641 above is designed for students in the Bridge Program. Attendance at an information session and special approval are needed to enroll in this learning community. This course is linked to COUN 5 (CRN 44293). For more information, please contact (909)274-5392.

42644 MW 9:45am - 11:50am Danson, E 26A-3610

NOTE: This class is linked to ENGL 66 (CRN 43009) and is an option only for ENGL 68 eligible students who have not already passed ENGL 68. This option allows students to bypass ENGL 68 and enroll in ENGL 1A only while taking an ENGL 66 section as a co-requisite. Please contact the Humanities and Social Sciences Division at (909)274-4570 with any questions.

42662 MW 9:45am - 11:50am Gomez, F 26D-3411
 42652 M 9:45am - 11:50am Alvarez, H 26A-3821
 and arrange 2.25 hours Alvarez, H ONLINE

NOTE: CRN 42652 is a Hybrid Class taught partially online with Scheduled Meetings on Campus.

How to Begin Course: Log into Canvas through <http://myportal.mtsac.edu> and click on CRN for your DL course. **NOTE:** Some courses may not be activated until the start of the term. If you cannot locate your DL course in Canvas when the term starts, contact the professor. **On the first day of classes, log into your DL course to show your "attendance" because not doing so could result in your being dropped from the class for non-attendance.**

Professor contact info: Email Professor Alvarez at either: HALvarez@mtsac.edu, through Student Detail Schedule or Canvas at MyMtSAC Portal.

Students must use their Mt. SAC e-mail account and be aware of course commitment and student expectations described at <http://www.mtsac.edu/instruction/learning/distlearn/>

To prepare for a successful online learning experience, see helpful short videos at <http://www.mtsac.edu/distancelearning/quiz/>

No cost digital textbooks or textual materials used.

42661 M 9:45am - 11:50am Allende, K 26A-3680
 and arrange 2.25 hours Allende, K ONLINE

NOTE: CRN 42661 is a Hybrid Class taught partially online with Scheduled Meetings on Campus.

How to Begin Course: Log into Canvas through <http://myportal.mtsac.edu> and click on CRN for your DL course. **NOTE:** Some courses may not be activated until the start of the term. If you cannot locate your DL course in Canvas when the term starts, contact the professor. **On the first day of classes, log into your DL course to show your "attendance" because not doing so could result in your being dropped from the class for non-attendance.**

Professor contact info: Email Professor Allende at either: KAllende@mtsac.edu, through Student Detail Schedule or Canvas at MyMtSAC Portal.

Students must use their Mt. SAC e-mail account and be aware of course commitment and student expectations described at <http://www.mtsac.edu/instruction/learning/distlearn/>

To prepare for a successful online learning experience, see helpful short videos at <http://www.mtsac.edu/distancelearning/quiz/>

42642 TTh 9:45am - 11:50am Boehner-Staylor, M 26A-3620
NOTE: CRN 42642 above is linked to SPCH 1A (CRN 42481).

42643 TTh 9:45am - 11:50am Karn, T 26D-2210

42663 TTh 9:45am - 11:50am Alvarez-Galvan, M 66-209

42665 TTh 9:45am - 11:50am Mattoon, M 211-2

42788 TTh 9:45am - 11:50am Loera-Ramirez, D 26D-G220
 and arrange 4.5 hours Loera-Ramirez, D ONLINE

8 Weeks, Week beginning 04/23/2018 ending 06/17/2018

NOTE: CRN 42788 is a Hybrid Class taught partially online with Scheduled Meetings on Campus.

How to Begin Course: Log into Canvas through <http://myportal.mtsac.edu> and click on CRN for your DL course. **NOTE:** Some courses may not be activated until the start of the term. If you cannot locate your DL course in Canvas when the term starts, contact the professor. **On the first day of classes, log into your DL course to show your "attendance" because not doing so could result in your being dropped from the class for non-attendance.**

Professor contact info: Email Professor Loera-Ramirez at either: DLoera@mtsac.edu, through Student Detail Schedule or Canvas at MyMtSAC Portal.

Students must use their Mt. SAC e-mail account and be aware of course commitment and student expectations described at <http://www.mtsac.edu/instruction/learning/distlearn/>

To prepare for a successful online learning experience, see helpful short videos at <http://www.mtsac.edu/distancelearning/quiz/>

42667 TThF 9:45am - 11:00am Enke, G 26A-3610

NOTE: CRN 42667 above is designed for students in the Bridge Program. Attendance at an information session and special approval are needed to enroll in this learning community. This course is linked to COUN 5 (CRN 44292). For more information, please contact (909)274-5392.

42625 W 9:45am - 11:50am Allende, K 26A-3680
 and arrange 2.25 hours Allende, K ONLINE

NOTE: CRN 42625 is a Hybrid Class taught partially online with Scheduled Meetings on Campus.

How to Begin Course: Log into Canvas through <http://myportal.mtsac.edu> and click on CRN for your DL course. **NOTE:** Some courses may not be activated until the start of the term. If you cannot locate your DL course in Canvas when the term starts, contact the professor. **On the first day of classes, log into your DL course to show your "attendance" because not doing so could result in your being dropped from the class for non-attendance.**

Professor contact info: Email Professor Allende at either: KAllende@mtsac.edu, through Student Detail Schedule or Canvas at MyMtSAC Portal.

Students must use their Mt. SAC e-mail account and be aware of course commitment and student expectations described at <http://www.mtsac.edu/instruction/learning/distlearn/>

To prepare for a successful online learning experience, see helpful short videos at <http://www.mtsac.edu/distancelearning/quiz/>

42790 W 9:45am - 11:50am Alvarez, H 26A-3821
 and arrange 2.25 hours Alvarez, H ONLINE

NOTE: CRN 42790 is a Hybrid Class taught partially online with Scheduled Meetings on Campus.

How to Begin Course: Log into Canvas through <http://myportal.mtsac.edu> and click on CRN for your DL course. **NOTE:** Some courses may not be activated until the start of the term. If you cannot locate your DL course in Canvas when the term starts, contact the professor. **On the first day of classes, log into your DL course to show your "attendance" because not doing so could result in your being dropped from the class for non-attendance.**

Professor contact info: Email Professor Alvarez at either: HALvarez@mtsac.edu, through Student Detail Schedule or Canvas at MyMtSAC Portal.

Students must use their Mt. SAC e-mail account and be aware of course commitment and student expectations described at <http://www.mtsac.edu/instruction/learning/distlearn/>

To prepare for a successful online learning experience, see helpful short videos at <http://www.mtsac.edu/distancelearning/quiz/>

No cost digital textbooks or textual materials used.

43040 TThF 11:30am - 12:45pm Enke, G 26A-3610

NOTE: CRN 43040 above is designed for students in the Dream Program. Attendance at an information session and special approval are needed to enroll in this learning community. This course is linked to Counseling 5 (CRN 44294). For information, please contact the Dream Program at (909)274-5596.

42645 MW 12:00pm - 2:05pm Olds, J 26D-3280

42646 MW 12:00pm - 2:05pm Gomez, F 26D-3411

42647 MW 12:00pm - 2:05pm Harper, M 26A-3881

42648 MW 12:00pm - 2:05pm Quintana-Mullane, K 26A-3690

NOTE: No cost digital textbooks or textual materials used. CRN 42648 above is designed for students in the Bridge Program. Attendance at an information session and special approval are needed to enroll in this learning community. This course is linked to COUN 5 (CRN 44362). For more information, please contact (909)274-5392.

42649 MW 12:00pm - 2:05pm STAFF 26A-3871

NOTE: This class is linked to ENGL 66 (CRN 43008) and is an option only for ENGL 68 eligible students who have not already passed ENGL 68. This option allows students to bypass ENGL 68 and enroll in ENGL 1A only while taking an ENGL 66 section as a co-requisite. Please contact the Humanities and Social Sciences Division at (909)274-4570 with any questions.

42655 MW 12:00pm - 2:05pm Kordich, J 26A-3831

42793 MW 12:00pm - 2:05pm Wong, A 26D-3491

42830 MW 12:00pm - 2:05pm Johnson, S 26D-3481

42791 M 12:00pm - 2:05pm Alvarez, H 26A-3821
and arrange 2.25 hours Alvarez, H ONLINE

NOTE: CRN 42791 is a Hybrid Class taught partially online with Scheduled Meetings on Campus.

How to Begin Course: Log into Canvas through <http://myportal.mtsac.edu> and click on CRN for your DL course. **NOTE:** Some courses may not be activated until the start of the term. If you cannot locate your DL course in Canvas when the term starts, contact the professor. **On the first day of classes, log into your DL course to show your "attendance" because not doing so could result in your being dropped from the class for non-attendance.**

Professor contact info: Email Professor Alvarez at either: HALvarez@mtsac.edu, through Student Detail Schedule or Canvas at MyMtSAC Portal.

Students must use their Mt. SAC e-mail account and be aware of course commitment and student expectations described at <http://www.mtsac.edu/instruction/learning/distlearn/>

To prepare for a successful online learning experience, see helpful short videos at <http://www.mtsac.edu/distancelearning/quiz/>

No cost digital textbooks or textual materials used.

42650 TTh 12:00pm - 2:05pm Lee, B 26B-3565

NOTE: CRN 42650 above is designed for students in the Bridge Program. Attendance at an information session and special approval are needed to enroll in this learning community. This course is linked to COUN 5 (CRN 44377). For more information, please contact (909)274-5392.

42651 TTh 12:00pm - 2:05pm Weidner, N 21G-1

NOTE: This class is linked to ENGL 66 (CRN 43013) and is an option only for ENGL 68 eligible students who have not already passed ENGL 68. This option allows students to bypass ENGL 68 and enroll in ENGL 1A only while taking an ENGL 66 section as a co-requisite. Please contact the Humanities and Social Sciences Division at (909)274-4570 with any questions.

42653 TTh 12:00pm - 2:05pm Cheng, P 21C-1

42654 TTh 12:00pm - 2:05pm Karn, T 26D-2210

42792 TTh 12:00pm - 2:05pm Loera-Ramirez, D 26D-G220
and arrange 4.5 hours Loera-Ramirez, D ONLINE

8 Weeks, Week beginning 04/23/2018 ending 06/17/2018

42831 TTh 12:00pm - 2:05pm McCombs, C 26A-3680

NOTE: No cost digital textbooks or textual materials used.

42896 TTh 12:00pm - 2:05pm Hallsted, C 26A-3871

44143 TTh 12:00pm - 2:05pm Mattoon, M 21I-2

42832 W 12:00pm - 2:05pm Alvarez, H 26A-3821
and arrange 2.25 hours Alvarez, H ONLINE

NOTE: CRN 42832 is a Hybrid Class taught partially online with Scheduled Meetings on Campus.

How to Begin Course: Log into Canvas through <http://myportal.mtsac.edu> and click on CRN for your DL course. **NOTE:** Some courses may not be activated until the start of the term. If you cannot locate your DL course in Canvas when the term starts, contact the professor. **On the first day of classes, log into your DL course to show your "attendance" because not doing so could result in your being dropped from the class for non-attendance.**

Professor contact info: Email Professor Alvarez at either: HALvarez@mtsac.edu, through Student Detail Schedule or Canvas at MyMtSAC Portal.

Students must use their Mt. SAC e-mail account and be aware of course commitment and student expectations described at <http://www.mtsac.edu/instruction/learning/distlearn/>

To prepare for a successful online learning experience, see helpful short videos at <http://www.mtsac.edu/distancelearning/quiz/>

No cost digital textbooks or textual materials used.

42656 F 1:30pm - 5:45pm Gomez, F 26A-3670

42657 MW 2:15pm - 4:20pm Trokkos, M 26A-3821

42658 MW 2:15pm - 4:20pm Wong, A 26D-3491

42664 MW 2:15pm - 4:20pm Stefan, J 26D-G220

42666 MW 2:15pm - 4:20pm Johnson, S 26D-3481

42668 MW 2:15pm - 4:20pm Montgomery, F 26A-3841

43034 MW 2:15pm - 4:20pm Redmon, P 26A-3881

42834 M 2:15pm - 4:20pm Olds, J 26D-3290
and arrange 2.25 hours Olds, J ONLINE

NOTE: CRN 42834 is a Hybrid Class taught partially online with Scheduled Meetings on Campus.

How to Begin Course: Log into Canvas through <http://myportal.mtsac.edu> and click on CRN for your DL course. **NOTE:** Some courses may not be activated until the start of the term. If you cannot locate your DL course in Canvas when the term starts, contact the professor. **On the first day of classes, log into your DL course to show your "attendance" because not doing so could result in your being dropped from the class for non-attendance.**

Professor contact info: Email Professor Olds at either: JOlds@mtsac.edu, through Student Detail Schedule or Canvas at MyMtSAC Portal.

Students must use their Mt. SAC e-mail account and be aware of course commitment and student expectations described at <http://www.mtsac.edu/instruction/learning/distlearn/>

To prepare for a successful online learning experience, see helpful short videos at <http://www.mtsac.edu/distancelearning/quiz/>

42669 TTh 2:15pm - 4:20pm Daigre, V 26A-3811

42670 TTh 2:15pm - 4:20pm Leader, J 66-209

42808 TTh 2:15pm - 4:20pm Ceniceroy, J 26A-1871

NOTE: This class is linked to ENGL 66 (CRN 44155) and is an option only for ENGL 68 eligible students who have not already passed ENGL 68. This option allows students to bypass ENGL 68 and enroll in ENGL 1A only while taking an ENGL 66 section as a co-requisite. Please contact the Humanities and Social Sciences Division at (909)274-4570 with any questions.

42841 TTh 2:15pm - 4:20pm Hallsted, C 26A-3871

42852 TTh 2:15pm - 4:20pm Gomez, F 26A-3670

42809 MW 4:30pm - 6:35pm Kordich, J 26A-3831

42811 MW 4:30pm - 6:35pm Myers, R 26A-1871

NOTE: This class is linked to ENGL 66 (CRN 43011) and is an option only for ENGL 68 eligible students who have not already passed ENGL 68. This option allows students to bypass ENGL 68 and enroll in ENGL 1A only while taking an ENGL 66 section as a co-requisite. Please contact the Humanities and Social Sciences Division at (909)274-4570 with any questions.

42812 MW 4:30pm - 6:35pm Stefan, J 26D-G220

42824 MW 4:30pm - 6:35pm Hight, L 26A-3881

42825 MW 4:30pm - 6:35pm Mullane, D 26A-3690

42826 MW 4:30pm - 6:35pm Olds, J 26D-3290

42848 MW 4:30pm - 6:35pm Montgomery, F 26A-3841

42849 MW 4:30pm - 6:35pm Zeledon, S 26A-3680

NOTE: This class is linked to ENGL 66 (CRN 44154) and is an option only for ENGL 68 eligible students who have not already passed ENGL 68. This option allows students to bypass ENGL 68 and enroll in ENGL 1A only while taking an ENGL 66 section as a co-requisite. Please contact the Humanities and Social Sciences Division at (909)274-4570 with any questions.

42860 MW 4:30pm - 6:35pm Trokkos, M 26A-3821

42881 MW 4:30pm - 6:35pm Mushik, M 26D-G471

42882 MW 4:30pm - 6:35pm Mc Kennon, A 26A-3610

42842 T 4:30pm - 6:35pm McFaul, J 26D-3280

and arrange 2.25 hours McFaul, J ONLINE

NOTE: CRN 42842 is a Hybrid Class taught partially online with Scheduled Meetings on Campus.

How to Begin Course: Log into Canvas through <http://myportal.mtsac.edu> and click on CRN for your DL course. **NOTE:** Some courses may not be activated until the start of the term. If you cannot locate your DL course in Canvas when the term starts, contact the professor. **On the first day of classes, log into your DL course to show your "attendance" because not doing so could result in your being dropped from the class for non-attendance.**

Professor contact info: Email Professor McFaul at either: JDMcFaul@mtsac.edu, through Student Detail Schedule or Canvas at MyMtSAC Portal.

Students must use their Mt. SAC e-mail account and be aware of course commitment and student expectations described at <http://www.mtsac.edu/instruction/learning/distlearn/>

To prepare for a successful online learning experience, see helpful short videos at <http://www.mtsac.edu/distancelearning/quiz/>

42880 T 4:30pm - 6:35pm Olds, J 26D-3290
and arrange 2.25 hours Olds, J ONLINE

NOTE: CRN 42880 is a Hybrid Class taught partially online with Scheduled Meetings on Campus.

How to Begin Course: Log into Canvas through <http://myportal.mtsac.edu> and click on CRN for your DL course. **NOTE:** Some courses may not be activated until the start of the term. If you cannot locate your DL course in Canvas when the term starts, contact the professor. **On the first day of classes, log into your DL course to show your "attendance" because not doing so could result in your being dropped from the class for non-attendance.**

Professor contact info: Email Professor Olds at either: JOlds@mtsac.edu, through Student Detail Schedule or Canvas at MyMtSAC Portal.

Students must use their Mt. SAC e-mail account and be aware of course commitment and student expectations described at <http://www.mtsac.edu/instruction/learning/distlearn/>

To prepare for a successful online learning experience, see helpful short videos at <http://www.mtsac.edu/distancelearning/quiz/>

42850 TTh 4:30pm - 6:35pm Matthews, A 26A-3871
42854 TTh 4:30pm - 6:35pm McCombs, C 26A-3680

NOTE: No cost digital textbooks or textual materials used.

42861 TTh 4:30pm - 6:35pm Daigre, V 26A-3811
42862 TTh 4:30pm - 6:35pm STAFF 26A-1871
42863 MW 6:45pm - 8:50pm Myers, R 26A-1871

NOTE: This class is linked to ENGL 66 (CRN 43012) and is an option only for ENGL 68 eligible students who have not already passed ENGL 68. This option allows students to bypass ENGL 68 and enroll in ENGL 1A only while taking an ENGL 66 section as a co-requisite. Please contact the Humanities and Social Sciences Division at (909)274-4570 with any questions.

42864 MW 6:45pm - 8:50pm Hight, L 26A-3881
42867 MW 6:45pm - 8:50pm Mullane, D 26A-3690
42868 MW 6:45pm - 8:50pm Olds, J 26D-3290
42883 T 6:45pm - 8:50pm McFaul, J 26D-3280
and arrange 2.25 hours McFaul, J ONLINE

NOTE: CRN 42883 is a Hybrid Class taught partially online with Scheduled Meetings on Campus.

How to Begin Course: Log into Canvas through <http://myportal.mtsac.edu> and click on CRN for your DL course. **NOTE:** Some courses may not be activated until the start of the term. If you cannot locate your DL course in Canvas when the term starts, contact the professor. **On the first day of classes, log into your DL course to show your "attendance" because not doing so could result in your being dropped from the class for non-attendance.**

Professor contact info: Email Professor McFaul at either: JDMcFaul@mtsac.edu, through Student Detail Schedule or Canvas at MyMtSAC Portal.

Students must use their Mt. SAC e-mail account and be aware of course commitment and student expectations described at <http://www.mtsac.edu/instruction/learning/distlearn/>

To prepare for a successful online learning experience, see helpful short videos at <http://www.mtsac.edu/distancelearning/quiz/>

42898 TTh 6:45pm - 8:50pm Denton, J 26A-3831
42899 TTh 6:45pm - 8:50pm Matthews, A 26A-3871
44475 T 6:45pm - 8:50pm Olds, J 26D-3290
and arrange 2.25 hours Olds, J ONLINE
42660 S 9:00am - 1:15pm Wright, S 26D-G220
43051 S 9:00am - 1:15pm Blean, N 26A-1871

■ ENGL 1AH — Freshman Composition - Honors 4.0 Units
(C-ID ENGL 100) Degree Applicable, CSU, UC

Prerequisite: Acceptance into the Honors Program

Honors course providing an enriched experience. May not receive credit for both ENGL 1A and ENGL 1AH.

42671 TTh 7:30am - 9:35am Cannon, H 26D-3491
42893 TTh 4:30pm - 6:35pm Ceniceroy, J 26A-2841

■ ENGL 1B — English - Introduction to Literary Types 3.0 Units
(C-ID ENGL 120) Degree Applicable, CSU, UC

Prerequisite: ENGL 1A or ENGL 1AH

Critical, oral, and written evaluation, analysis, and interpretation of short and long fiction, poetry, and drama.

42672 MW 12:00pm - 1:25pm Loera-Ramirez, D 26A-3610
42674 TTh 12:00pm - 1:25pm Piluso, R 18-1
42851 W 7:00pm - 10:10pm Brantingham, J 26D-3411
42673 Th 7:00pm - 10:10pm Muniz, E 26A-1871

■ ENGL 1C — Critical Thinking and Writing 4.0 Units
(C-ID ENGL 105) Degree Applicable, CSU, UC

Prerequisite: ENGL 1A or ENGL 1AH

Develops critical thinking, reading, and writing skills. Focuses on logical analysis and argumentative writing.

42675 MTWTh 7:30am - 9:35am Piluso, R 18-1
8 Weeks, Week beginning 04/23/2018 ending 06/17/2018

NOTE: CRN 42675 is linked to CRN 42659 and is a part of the Pathways Program. This course is continuing from the Winter term and seats are reserved for students already in the program. Any additional seats will be open for registration to any eligible student. This course is a part of English Cohort #7. If you have any questions please email pathways@mtsac.edu or call (909) 274-5703.

42902 MTWTh 7:30am - 9:35am Hernandez, L 26A-3690
8 Weeks, Week beginning 04/23/2018 ending 06/17/2018

NOTE: CRN 42902 is linked to CRN 42630 and is a part of the Pathways Program. This course is continuing from the Winter term and seats are reserved for students already in the program. Any additional seats will be open for registration to any eligible student. This course is a part of English Cohort #8. If you have any questions please email pathways@mtsac.edu or call (909) 274-5703.

42676 MW 7:30am - 9:35am Pappas, G 26A-2841
42677 MW 7:30am - 9:35am Vargas, A 26A-3811
42678 TTh 7:30am - 9:35am Harper, M 26A-3881
42679 TTh 7:30am - 9:35am Pappas, G 26A-2841
42680 TTh 7:30am - 9:35am Vargas, A 26A-3811
43053 TThF 8:00am - 9:15am Enke, G 26A-3610
42681 F 9:00am - 1:15pm Francev, P 26A-3690
42682 F 9:00am - 1:15pm Callaci, A 26A-3811
42684 MTWTh 9:45am - 11:50am Piluso, R 18-1
8 Weeks, Week beginning 04/23/2018 ending 06/17/2018

42683 MW 9:45am - 11:50am Hallsted, C 18-11
NOTE: CRN 42683 is a part of the Pathways Program and is continuing from the Fall semester. Seats are reserved for students already in the program. Any additional seats will be open for registration to any eligible student. This course is a part of English Cohort #2. If you have any questions please email pathways@mtsac.edu or call (909) 274-5703.

42685 MW 9:45am - 11:50am Thomas, J 26D-3290
42686 MW 9:45am - 11:50am Mageean, M 26A-3670
42799 M 9:45am - 11:50am O'Brien, P 26A-2841
and arrange 2.25 hours O'Brien, P ONLINE

NOTE: CRN 42799 is a Hybrid Class taught partially online with Scheduled Meetings on Campus.

How to Begin Course: Log into Canvas through <http://myportal.mtsac.edu> and click on CRN for your DL course. **NOTE:** Some courses may not be activated until the start of the term. If you cannot locate your DL course in Canvas when the term starts, contact the professor. **On the first day of classes, log into your DL course to show your "attendance" because not doing so could result in your being dropped from the class for non-attendance.**

Professor contact info: Email Professor O'Brien at either: PO'Brien@mtsac.edu, through Student Detail Schedule or Canvas at MyMtSAC Portal.

Students must use their Mt. SAC e-mail account and be aware of course commitment and student expectations described at <http://www.mtsac.edu/instruction/learning/distlearn/>

To prepare for a successful online learning experience, see helpful short videos at <http://www.mtsac.edu/distancelearning/quiz/>

42795 T 9:45am - 11:50am O'Brien, P 26A-2841
and arrange 2.25 hours O'Brien, P ONLINE

NOTE: CRN 42795 is a Hybrid Class taught partially online with Scheduled Meetings on Campus.

How to Begin Course: Log into Canvas through <http://myportal.mtsac.edu> and click on CRN for your DL course. **NOTE:** Some courses may not be activated until the start of the term. If you cannot locate your DL course in Canvas when the term starts, contact the professor. **On the first day of classes, log into your DL course to show your "attendance" because not doing so could result in your being dropped from the class for non-attendance.**

Professor contact info: Email Professor O'Brien at either: PO'Brien@mtsac.edu, through Student Detail Schedule or Canvas at MyMtSAC Portal.

Students must use their Mt. SAC e-mail account and be aware of course commitment and student expectations described at <http://www.mtsac.edu/instruction/learning/distlearn/>

To prepare for a successful online learning experience, see helpful short videos at <http://www.mtsac.edu/distancelearning/quiz/>

42687 TTh 9:45am - 11:50am Alvarez, H 21F-2

42688 TTh 9:45am - 11:50am Harper, M 26A-3881

42689 TTh 9:45am - 11:50am Mageean, M 26A-3670

42774 TTh 9:45am - 11:50am Quintana-Mullane, K 26A-3690

NOTE: No cost digital textbooks or textual materials used.

42784 TTh 9:45am - 11:50am Thomas, J 26D-3290

42801 W 9:45am - 11:50am O'Brien, P 26A-2841

and arrange 2.25 hours O'Brien, P ONLINE

NOTE: CRN 42801 is a Hybrid Class taught partially online with Scheduled Meetings on Campus.

How to Begin Course: Log into Canvas through <http://myportal.mtsac.edu> and click on CRN for your DL course. **NOTE:** Some courses may not be activated until the start of the term. If you cannot locate your DL course in Canvas when the term starts, contact the professor. **On the first day of classes, log into your DL course to show your "attendance" because not doing so could result in your being dropped from the class for non-attendance.**

Professor contact info: Email Professor O'Brien at either: PO'Brien@mtsac.edu, through Student Detail Schedule or Canvas at MyMtSAC Portal.

Students must use their Mt. SAC e-mail account and be aware of course commitment and student expectations described at <http://www.mtsac.edu/instruction/learning/distlearn/>

To prepare for a successful online learning experience, see helpful short videos at <http://www.mtsac.edu/distancelearning/quiz/>

42796 Th 9:45am - 11:50am O'Brien, P 26A-2841

and arrange 2.25 hours O'Brien, P ONLINE

NOTE: CRN 42796 is a Hybrid Class taught partially online with Scheduled Meetings on Campus.

How to Begin Course: Log into Canvas through <http://myportal.mtsac.edu> and click on CRN for your DL course. **NOTE:** Some courses may not be activated until the start of the term. If you cannot locate your DL course in Canvas when the term starts, contact the professor. **On the first day of classes, log into your DL course to show your "attendance" because not doing so could result in your being dropped from the class for non-attendance.**

Professor contact info: Email Professor O'Brien at either: PO'Brien@mtsac.edu, through Student Detail Schedule or Canvas at MyMtSAC Portal.

Students must use their Mt. SAC e-mail account and be aware of course commitment and student expectations described at <http://www.mtsac.edu/instruction/learning/distlearn/>

To prepare for a successful online learning experience, see helpful short videos at <http://www.mtsac.edu/distancelearning/quiz/>

42813 MW 12:00pm - 2:05pm Mageean, M 26A-3670

42816 MW 12:00pm - 2:05pm Thomas, J 26D-3290

42820 MW 12:00pm - 2:05pm Hallsted, C 18-11

NOTE: CRN 42820 is a part of the Pathways Program and is continuing from the Fall semester. Seats are reserved for students already in the program. Any additional seats will be open for registration to any eligible student. This course is a part of English Cohort #4. If you have any questions please email pathways@mtsac.edu or call (909) 274-5703.

42836 MW 12:00pm - 2:05pm Muniz, E 26A-1871

42797 M 12:00pm - 2:05pm Mc Cormick, E 26A-3680

and arrange 2.25 hours Mc Cormick, E ONLINE

NOTE: CRN 42797 is a Hybrid Class taught partially online with Scheduled Meetings on Campus.

How to Begin Course: Log into Canvas through <http://myportal.mtsac.edu> and click on CRN for your DL course. **NOTE:** Some courses may not be activated until the start of the term. If you cannot locate your DL course in Canvas when the term starts, contact the professor. **On the first day of classes, log into your DL course to show your "attendance" because not doing so could result in your being dropped from the class for non-attendance.**

Professor contact info: Email Professor McCormick at either: BMCormick@mtsac.edu, through Student Detail Schedule or Canvas at MyMtSAC Portal.

Students must use their Mt. SAC e-mail account and be aware of course commitment and student expectations described at <http://www.mtsac.edu/instruction/learning/distlearn/>

To prepare for a successful online learning experience, see helpful short videos at <http://www.mtsac.edu/distancelearning/quiz/>

42819 TTh 12:00pm - 2:05pm Kordich, J 26A-3831

42821 TTh 12:00pm - 2:05pm Harper, M 26A-3881

42822 TTh 12:00pm - 2:05pm Quintana-Mullane, K 26A-3690

NOTE: No cost digital textbooks or textual materials used.

42829 TTh 12:00pm - 2:05pm Thomas, J 26D-3290

42837 TTh 12:00pm - 2:05pm Alvarez, H 21F-2

42845 TTh 12:00pm - 2:05pm Greenberg, H 66-246

42800 W 12:00pm - 2:05pm Mc Cormick, E 26A-3680

and arrange 2.25 hours Mc Cormick, E ONLINE

NOTE: CRN 42800 is a Hybrid Class taught partially online with Scheduled Meetings on Campus.

How to Begin Course: Log into Canvas through <http://myportal.mtsac.edu> and click on CRN for your DL course. **NOTE:** Some courses may not be activated until the start of the term. If you cannot locate your DL course in Canvas when the term starts, contact the professor. **On the first day of classes, log into your DL course to show your "attendance" because not doing so could result in your being dropped from the class for non-attendance.**

Professor contact info: Email Professor McCormick at either: BMCormick@mtsac.edu, through Student Detail Schedule or Canvas at MyMtSAC Portal.

Students must use their Mt. SAC e-mail account and be aware of course commitment and student expectations described at <http://www.mtsac.edu/instruction/learning/distlearn/>

To prepare for a successful online learning experience, see helpful short videos at <http://www.mtsac.edu/distancelearning/quiz/>

42833 F 1:30pm - 5:45pm Francev, P 26A-3690

42835 MW 2:15pm - 4:20pm Mushik, M 26D-G471

42840 T 2:15pm - 4:20pm Mc Cormick, E 26A-3680
and arrange 2.25 hours Mc Cormick, E ONLINE

NOTE: CRN 42840 is a Hybrid Class taught partially online with Scheduled Meetings on Campus.

How to Begin Course: Log into Canvas through <http://myportal.mtsac.edu> and click on CRN for your DL course. **NOTE:** Some courses may not be activated until the start of the term. If you cannot locate your DL course in Canvas when the term starts, contact the professor. **On the first day of classes, log into your DL course to show your "attendance" because not doing so could result in your being dropped from the class for non-attendance.**

Professor contact info: Email Professor McCormick at either: BMcCormick@mtsac.edu, through Student Detail Schedule or Canvas at MyMtSAC Portal.

Students must use their Mt. SAC e-mail account and be aware of course commitment and student expectations described at <http://www.mtsac.edu/instruction/learning/distlearn/>

To prepare for a successful online learning experience, see helpful short videos at <http://www.mtsac.edu/distancelearning/quiz/>

42798	TTh	2:15pm - 4:20pm	Kordich, J	26A-3831
42855	TTh	2:15pm - 4:20pm	Greenberg, H	66-246
43057	TTh	2:15pm - 4:20pm	Muniz, E	26D-2210
42794	MW	4:30pm - 6:35pm	Muniz, E	26D-2210
42817	MW	4:30pm - 6:35pm	Moore, B	26A-2841
43063	MW	4:30pm - 6:35pm	Brantingham, J	26D-3411
42803	TTh	4:30pm - 6:35pm	Gomez, F	26A-3670
42818	TTh	4:30pm - 6:35pm	Brantingham, J	26D-3411
42907	TTh	4:30pm - 6:35pm	Pedroja, J	26D-3491
43058	TTh	4:30pm - 6:35pm	Mattoon, M	26A-3881
42844	Th	4:30pm - 6:35pm	McFaul, J	26D-3280

and arrange 2.25 hours McFaul, J ONLINE

NOTE: CRN 42844 is a Hybrid Class taught partially online with Scheduled Meetings on Campus.

How to Begin Course: Log into Canvas through <http://myportal.mtsac.edu> and click on CRN for your DL course. **NOTE:** Some courses may not be activated until the start of the term. If you cannot locate your DL course in Canvas when the term starts, contact the professor. **On the first day of classes, log into your DL course to show your "attendance" because not doing so could result in your being dropped from the class for non-attendance.**

Professor contact info: Email Professor McFaul at either: JDMcFaul@mtsac.edu, through Student Detail Schedule or Canvas at MyMtSAC Portal.

Students must use their Mt. SAC e-mail account and be aware of course commitment and student expectations described at <http://www.mtsac.edu/instruction/learning/distlearn/>

To prepare for a successful online learning experience, see helpful short videos at <http://www.mtsac.edu/distancelearning/quiz/>

42865	MW	6:45pm - 8:50pm	Moore, B	26A-2841
42909	TTh	6:45pm - 8:50pm	Buckwalter, M	26A-3690
43059	TTh	6:45pm - 8:50pm	Mattoon, M	26A-3881
43060	TTh	6:45pm - 8:50pm	Pedroja, J	26D-3491

42843 Th 6:45pm - 8:50pm McFaul, J 26D-3280
and arrange 2.25 hours McFaul, J ONLINE

NOTE: CRN 42843 is a Hybrid Class taught partially online with Scheduled Meetings on Campus.

How to Begin Course: Log into Canvas through <http://myportal.mtsac.edu> and click on CRN for your DL course. **NOTE:** Some courses may not be activated until the start of the term. If you cannot locate your DL course in Canvas when the term starts, contact the professor. **On the first day of classes, log into your DL course to show your "attendance" because not doing so could result in your being dropped from the class for non-attendance.**

Professor contact info: Email Professor Horton at either: THorton@mtsac.edu, through Student Detail Schedule or Canvas at MyMtSAC Portal.

Students must use their Mt. SAC e-mail account and be aware of course commitment and student expectations described at <http://www.mtsac.edu/instruction/learning/distlearn/>

To prepare for a successful online learning experience, see helpful short videos at <http://www.mtsac.edu/distancelearning/quiz/>

■ ENGL 1CH — Critical Thinking and Writing - Honors 4.0 Units
(C-ID ENGL 105) Degree Applicable, CSU, UC

Prerequisite: ENGL 1A or ENGL 1AH and acceptance into the Honors Program

An honors course designed to provide an enriched experience. May not receive credit for both ENGL 1C and ENGL 1CH.

42690 MW 7:30am - 9:35am Cannon, H 26D-3491

NOTE: CRN 42690 above is linked to MUS 13H (CRN 43815) and is designated for students in the Honors Fast Track Program. Please call the Honors Program at (909)274-4665 for further information.

42815 MW 9:45am - 11:50am Cannon, H 26D-3491
42866 TTh 6:45pm - 8:50pm Brantingham, J 26D-3411

■ ENGL 8A — Creative Writing - Fiction 3.0 Units
Degree Applicable, CSU, UC

(May be taken for option of Letter grade or Pass/NoPass)

Prerequisite: ENGL 1A or ENGL 1AH

Elements, processes, and techniques of fiction writing with an emphasis on student development as a writer of fiction.

42766 TTh 1:45pm - 3:10pm Brantingham, J 26D-3411

■ ENGL 8F — Creative Writing - Nonfiction 3.0 Units
Degree Applicable, CSU, UC

(May be taken for option of Letter grade or Pass/NoPass)

Prerequisite: ENGL 1A

Analysis and writing of creative nonfiction including stylistic and syntactic forms and composition strategies.

42767 TTh 9:45am - 11:10am Bartman, S 26A-3821

■ ENGL 64 — Writing Effective Sentences 1.0 Unit
Not Degree Applicable

(May be taken for option of Letter grade or Pass/NoPass)

Prerequisite: Eligibility for ENGL 67

Improves sentence skills through application of sentence elements and identification and correction of common sentence problems.

44151 TTh 2:30pm - 3:35pm Farve, D 26A-3891
8 Weeks, Week beginning 02/26/2018 ending 04/22/2018

NOTE: CRN 44151 above is linked to ENGL 66 (CRN 44152).

ENGLISH



The English Bridge provides a combination of English and Counseling courses for students seeking a unique learning experience. In addition, students will learn what it takes to succeed in college and beyond. Students will work in teams and receive tutoring in these courses. (Tutoring upon availability and by instructor request). Please contact the Bridge Program at (909)274-5392 or come in person to the Student Success Center, Bldg. 9E (2nd Floor) to **reserve your space for attendance** at any one of our Information Sessions. **Space is limited!** If you would like to find out more information and/or you are interested in enrolling in the Bridge Program, visit us at the Student Services Annex, Bldg. 9D or online at www.mtsac.edu/students/bridge/.

ENGLISH BRIDGE SPRING 2018 COURSES

CLUSTER 1

Link 1

ENGL 67*

42697 MTWTh 9:45 am - 11:50 am Frahs, P. 4 units 26A-3811

*First 8 weeks, beginning February 26, 2018 and ending on April 22, 2018

ENGL 68*

42729 MTWTh 9:45 am - 11:50 am Frahs, P. 4 units 26A-3811

*Second 8 weeks, beginning April 23, 2018, and ending on June 17, .

COUN 2

44290 MW 8:00 am - 9:25 am Hart, J. 3 units 12-1020

NOTE: Attendance at an information session and special approval are needed to enroll in this learning community.

CLUSTER 2

Link 1

ENGL 1A

42641 MW 9:45 am - 11:50 am Estrada, M. 4 units 26A-3871

COUN 5

44293 TTh 9:45 am - 11:10 am Ton, C. 3 units 12-1080

NOTE: Attendance at an information session and special approval are needed to enroll in this learning community.

CLUSTER 2

Link 2

ENGL 1A

42640 MW 9:45 am - 11:50 am Quintana-Mullane, K. 4 units 26A-3690

COUN 5

44360 TTh 9:45 am - 11:10 am Trejo, L. 3 units TBA

NOTE: Attendance at an information session and special approval are needed to enroll in this learning community.

Link 3

ENGL 1A

42648 MW 12:00 pm - 2:05 pm Quintana-Mullane, K. 4 units 26A-3690

COUN 5

44362 TTh 11:30 am - 12:55 pm Trejo, L. 3 units TBA

NOTE: Attendance at an information session and special approval are needed to enroll in this learning community.

Link 4

ENGL 1A

42667 TThF 9:45 am - 11:00 am Enke, G. 4 units 26A-3610

COUN 5

44292 TTh 11:30 am - 12:55 pm Perez, A. 3 units 12-1080

NOTE: Attendance at an information session and special approval are needed to enroll in this learning community.

Link 5

ENGL 1A

42650 TTh 12:00 pm - 2:05 pm Lee, B. 4 units 26B-3565

COUN 5

44377 TTh 9:45 am - 11:10 am Flameno, B. 3 units 211 - 1

NOTE: Attendance at an information session and special approval are needed to enroll in this learning community.

ENGLISH BRIDGE INFORMATION SESSIONS

Visit us at <http://www.mtsac.edu/bridge/communities.html> for an updated schedule of Bridge Information Sessions.

Interested in attending a Bridge Information Session? To attend an Information Session, please follow these steps:

1. A Mt. SAC student **MUST attend one** of the English Bridge Information Sessions to be considered for enrollment into any of the Bridge Program learning communities. This session is an opportunity for students to find out about the Bridge Program and whether our learning communities will be a good fit academically for you.
2. Please contact us at (909) 274-5392 or visit us at the Student Services Annex, Bldg. 9D to **reserve your space** at one of our Information Sessions. **Space is limited!**
3. Please be prepared and have knowledge of your Mt. SAC student I.D. number and what courses you are eligible for.
4. Limited seating is available in every session. Attendance at an Information Session **does not guarantee enrollment** into the Bridge Program classes. Availability of spaces in the Bridge Program learning communities are subject to change and are based on several factors such as, but not limited to: student's placement test results, open spaces in our classes, and/or courses already taken either at Mt. SAC or another college.

ENGL 66 — Paragraph Writing**1.0 Unit**

Not Degree Applicable

(May be taken for option of Letter grade or Pass/NoPass)

Analysis and writing of paragraphs. Through the process of writing, the student learns to state and support a topic idea.

43009 W 8:30am - 9:35am Danson, E 26A-3610

NOTE: This class is linked to ENGL 1A (CRN 42644) and is an option only for ENGL 68 eligible students who have not already passed ENGL 68. This option allows students to bypass ENGL 68 and enroll in ENGL 1A only while taking an ENGL 66 section as a co-requisite. Please contact the Humanities and Social Sciences Division at (909)274-4570 with any questions.

43012 M 9:00am - 10:05am Myers, R 26A-1871

NOTE: This class is linked to ENGL 1A (CRN 42863) and is an option only for ENGL 68 eligible students who have not already passed ENGL 68. This option allows students to bypass ENGL 68 and enroll in ENGL 1A only while taking an ENGL 66 section as a co-requisite. Please contact the Humanities and Social Sciences Division at (909)274-4570 with any questions.

43010 T 9:45am - 10:50am Weidner, N 21A-2

NOTE: This class is linked to ENGL 1A (CRN 42631) and is an option only for ENGL 68 eligible students who have not already passed ENGL 68. This option allows students to bypass ENGL 68 and enroll in ENGL 1A only while taking an ENGL 66 section as a co-requisite. Please contact the Humanities and Social Sciences Division at (909)274-4570 with any questions.

43013 Th 10:45am - 11:50am Weidner, N 21A-2

NOTE: This class is linked to ENGL 1A (CRN 42651) and is an option only for ENGL 68 eligible students who have not already passed ENGL 68. This option allows students to bypass ENGL 68 and enroll in ENGL 1A only while taking an ENGL 66 section as a co-requisite. Please contact the Humanities and Social Sciences Division at (909)274-4570 with any questions.

44155 T 1:00pm - 2:05pm Cenicerroz, J 26A-1871

NOTE: This class is linked to ENGL 1A (CRN 42808) and is an option only for ENGL 68 eligible students who have not already passed ENGL 68. This option allows students to bypass ENGL 68 and enroll in ENGL 1A only while taking an ENGL 66 section as a co-requisite. Please contact the Humanities and Social Sciences Division at (909)274-4570 with any questions.

43008 M 2:15pm - 3:20pm STAFF 26A-3871

NOTE: This class is linked to ENGL 1A (CRN 42649) and is an option only for ENGL 68 eligible students who have not already passed ENGL 68. This option allows students to bypass ENGL 68 and enroll in ENGL 1A only while taking an ENGL 66 section as a co-requisite. Please contact the Humanities and Social Sciences Division at (909)274-4570 with any questions.

44152 TTh 2:30pm - 3:35pm Farve, D 26A-3891

8 Weeks, Week beginning 04/23/2018 ending 06/17/2018**NOTE:** CRN 44152 above is linked to ENGL 64 (CRN 44151).

43011 M 3:00pm - 4:05pm Myers, R 26A-1871

NOTE: This class is linked to ENGL 1A (CRN 42811) and is an option only for ENGL 68 eligible students who have not already passed ENGL 68. This option allows students to bypass ENGL 68 and enroll in ENGL 1A only while taking an ENGL 66 section as a co-requisite. Please contact the Humanities and Social Sciences Division at (909)274-4570 with any questions.

44154 W 6:45pm - 7:50pm Zeledon, S 26A-3680

NOTE: This class is linked to ENGL 1A (CRN 42849) and is an option only for ENGL 68 eligible students who have not already passed ENGL 68. This option allows students to bypass ENGL 68 and enroll in ENGL 1A only while taking and ENGL 66 section as a co-requisite. Please contact the Humanities and Social Sciences Division at (909)274-4570 with any questions.

ENGL 67 — Writing Fundamentals**4.0 Units**

Not Degree Applicable

(May be taken for option of Letter grade or Pass/NoPass)

Prerequisite: Satisfactory score on the English Placement Test or completion of AMLA 42W or completion of LERN 81

Emphasizes sentence, outlining, summary, paragraph and essay skills, and critical thinking through combining reading and writing.

42691 MW 7:30am - 9:35am Romero, A 21A-2

42698 MW 7:30am - 9:35am Hight, L 26A-3831

42692 TTh 7:30am - 9:35am Estrada, M 26A-3871

16 Weeks, Week beginning 02/26/2018 ending 06/17/2018

42693 TTh 7:30am - 9:35am Hight, L 26A-3831

42698 WF 7:30am - 9:35am Alvarez-Galvan, M 26D-3481

42696 F 9:00am - 1:15pm Chaffin, D 26A-3680

42697 MTWTh 9:45am - 11:50am Frahs, P 26A-3811

8 Weeks, Week beginning 02/26/2018 ending 04/22/2018**NOTE:** CRN 42697 above is designed for students in the Bridge Program.

Attendance at an information session and special approval are needed to enroll in this learning community. This course is linked to ENGL 68 (CRN 42729) and COUN 2 (CRN 44290). For more information, please contact (909)274-5392.

42700 MW 9:45am - 11:50am Romero, A 21A-2

42701 MW 9:45am - 11:50am Wright, J 26A-3841

42702 MW 9:45am - 11:50am Leader, J 21G-2

42699 TTh 9:45am - 11:50am Estrada, M 26A-3871

43055 TTh 9:45am - 11:50am Wright, J 26A-3841

42703 WF 9:45am - 11:50am Alvarez-Galvan, M 26D-3481

42709 MTWTh 12:00pm - 2:05pm Frahs, P 26A-3811

8 Weeks, Week beginning 02/26/2018 ending 04/22/2018

42708 MW 12:00pm - 2:05pm Wright, J 26A-3841

43056 MW 12:00pm - 2:05pm STAFF 20-1

42704 TTh 12:00pm - 2:05pm McFaul, J 26D-3280

42705 TTh 12:00pm - 2:05pm Bartman, S 26A-3821

42707 TTh 12:00pm - 2:05pm Leader, J 66-209

43024 TThF 12:30pm - 1:45pm Avila, R 26D-3491

42711 F 1:30pm - 5:45pm Chaffin, D 26A-3680

43025 TThF 2:00pm - 3:15pm Avila, R 26D-3491

42712 MW 2:15pm - 4:20pm Lynch, C 26A-3811

42713 MW 2:15pm - 4:20pm Gonzalez, M 26A-3670

42706 TTh 2:15pm - 4:20pm Redmon, P 26A-3881

43026 TTh 2:15pm - 4:20pm McFaul, J 26D-3280

42710 MW 4:30pm - 6:35pm Gonzalez, M 26A-3670**42714 MW 4:30pm - 6:35pm Lynch, C 26A-3811****42715 TTh 4:30pm - 6:35pm Lam, W 26A-3620****42716 TTh 4:30pm - 6:35pm Hancock, J 26D-3481****42806 TTh 6:45pm - 8:50pm Hancock, J 26D-3481****42810 TTh 6:45pm - 8:50pm Lam, W 26A-3620**

■ **ENGL 68 — Preparation for College Writing** **4.0 Units**
Not Degree Applicable

(May be taken for option of Letter grade or Pass/NoPass)

Prerequisite: ENGL 67 or AMLA 43W or satisfactory score on the English Placement Test

Development of the academic essay based on critical reading of texts.

42718 MTWTh 7:30am - 9:35am Tolliver, T 26D-2210
8 Weeks, Week beginning 02/26/2018 ending 04/22/2018

NOTE: CRN 42718 is linked to CRN 42789 and is a part of the Pathways Program. This course is continuing from the Winter term and seats are reserved for students already in the program. Any additional seats will be open for registration to any eligible student. This course is a part of English Cohort #9. If you have any questions please email pathways@mtsac.edu or call (909) 274-5703.

42739 MW 7:30am - 9:35am Cascella, H 21H-1
43028 MW 7:30am - 9:35am Ramos, C 21J-1
42721 TTh 7:30am - 9:35am Karim, R 26D-G471
42731 TTh 7:30am - 9:35am Churchill, P 26D-3280
42726 F 8:00am - 12:15pm Key Ketter, L 26A-1871
42727 F 9:00am - 1:15pm Cushing, W 26A-3821
42737 TThF 9:30am - 10:45am Avila, R 26D-3411
42729 MTWTh 9:45am - 11:50am Frahs, P 26A-3811
8 Weeks, Week beginning 04/23/2018 ending 06/17/2018

NOTE: CRN 42729 above is designed for students in the Bridge Program. Attendance at an information session and special approval are needed to enroll in this learning community. This course is linked to ENGL 67 (CRN 42697) and COUN 2 (CRN 44290). For more information, please contact (909)274-5392.

42730 MW 9:45am - 11:50am Cascella, H 21H-1
42734 MW 9:45am - 11:50am Ramos, C 21J-1
42735 MW 9:45am - 11:50am Karn, T 26D-2210
42736 MW 9:45am - 11:50am Brandler, M 17-9
42740 MW 9:45am - 11:50am Farve, D 26A-3891
43029 MW 9:45am - 11:50am Hight, L 26A-3831
42786 T 9:45am - 11:50am Arterburn, P 26D-3481
and arrange 2.25 hours Arterburn, P ONLINE

NOTE: CRN 42786 is a Hybrid Class taught partially online with Scheduled Meetings on Campus.

How to Begin Course: Log into Canvas through <http://myportal.mtsac.edu> and click on CRN for your DL course. **NOTE:** Some courses may not be activated until the start of the term. If you cannot locate your DL course in Canvas when the term starts, contact the professor. **On the first day of classes, log into your DL course to show your "attendance" because not doing so could result in your being dropped from the class for non-attendance.**

Professor contact info: Email Professor Arterburn at either: PArterburn@mtsac.edu, through Student Detail Schedule or Canvas at MyMtSAC Portal.

Students must use their Mt. SAC e-mail account and be aware of course commitment and student expectations described at <http://www.mtsac.edu/instruction/learning/distlearn/>

To prepare for a successful online learning experience, see helpful short videos at <http://www.mtsac.edu/distancelearning/quiz/>

42741 TTh 9:45am - 11:50am Hight, L 26A-3831
42742 TTh 9:45am - 11:50am Churchill, P 26D-3280

42785 TTh 9:45am - 11:50am Loera-Ramirez, D 26D-G220
and arrange 4.5 hours Loera-Ramirez, D ONLINE
8 Weeks, Week beginning 02/26/2018 ending 04/22/2018

NOTE: CRN 42785 is a Hybrid Class taught partially online with Scheduled Meetings on Campus.

How to Begin Course: Log into Canvas through <http://myportal.mtsac.edu> and click on CRN for your DL course. **NOTE:** Some courses may not be activated until the start of the term. If you cannot locate your DL course in Canvas when the term starts, contact the professor. **On the first day of classes, log into your DL course to show your "attendance" because not doing so could result in your being dropped from the class for non-attendance.**

Professor contact info: Email Professor Loera-Ramirez at either: DLoera@mtsac.edu, through Student Detail Schedule or Canvas at MyMtSAC Portal.

Students must use their Mt. SAC e-mail account and be aware of course commitment and student expectations described at <http://www.mtsac.edu/instruction/learning/distlearn/>

To prepare for a successful online learning experience, see helpful short videos at <http://www.mtsac.edu/distancelearning/quiz/>

42856 Th 9:45am - 11:50am Arterburn, P 26D-3481
and arrange 2.25 hours Arterburn, P ONLINE

NOTE: CRN 42856 is a Hybrid Class taught partially online with Scheduled Meetings on Campus.

How to Begin Course: Log into Canvas through <http://myportal.mtsac.edu> and click on CRN for your DL course. **NOTE:** Some courses may not be activated until the start of the term. If you cannot locate your DL course in Canvas when the term starts, contact the professor. **On the first day of classes, log into your DL course to show your "attendance" because not doing so could result in your being dropped from the class for non-attendance.**

Professor contact info: Email Professor Arterburn at either: PArterburn@mtsac.edu, through Student Detail Schedule or Canvas at MyMtSAC Portal.

Students must use their Mt. SAC e-mail account and be aware of course commitment and student expectations described at <http://www.mtsac.edu/instruction/learning/distlearn/>

To prepare for a successful online learning experience, see helpful short videos at <http://www.mtsac.edu/distancelearning/quiz/>

42733 TThF 11:00am - 12:15pm Avila, R 26D-3411
42738 MTWTh 12:00pm - 2:05pm Frahs, P 26A-3811
8 Weeks, Week beginning 04/23/2018 ending 06/17/2018

42743 MW 12:00pm - 2:05pm Brandler, M 17-9
42744 MW 12:00pm - 2:05pm Farve, D 26A-3891
42745 MW 12:00pm - 2:05pm Boehner-Staylor, M 26A-3620
42746 MW 12:00pm - 2:05pm Karn, T 26D-2210
42857 T 12:00pm - 2:05pm Arterburn, P 26D-3481
and arrange 2.25 hours Arterburn, P ONLINE

NOTE: CRN 42857 is a Hybrid Class taught partially online with Scheduled Meetings on Campus.

How to Begin Course: Log into Canvas through <http://myportal.mtsac.edu> and click on CRN for your DL course. **NOTE:** Some courses may not be activated until the start of the term. If you cannot locate your DL course in Canvas when the term starts, contact the professor. **On the first day of classes, log into your DL course to show your "attendance" because not doing so could result in your being dropped from the class for non-attendance.**

Professor contact info: Email Professor Arterburn at either: PArterburn@mtsac.edu, through Student Detail Schedule or Canvas at MyMtSAC Portal.

Students must use their Mt. SAC e-mail account and be aware of course commitment and student expectations described at <http://www.mtsac.edu/instruction/learning/distlearn/>

To prepare for a successful online learning experience, see helpful short videos at <http://www.mtsac.edu/distancelearning/quiz/>

42747 TTh 12:00pm - 2:05pm Boehner-Staylor, M 26A-3620
42748 TTh 12:00pm - 2:05pm Farve, D 26A-3891
42749 TTh 12:00pm - 2:05pm Staylor, D 40-129

42787 TTh 12:00pm - 2:05pm Loera-Ramirez, D 26D-G220
and arrange 4.5 hours Loera-Ramirez, D ONLINE
8 Weeks, Week beginning 02/26/2018 ending 04/22/2018

NOTE: CRN 42787 is a Hybrid Class taught partially online with Scheduled Meetings on Campus.

How to Begin Course: Log into Canvas through <http://myportal.mtsac.edu> and click on CRN for your DL course. **NOTE:** Some courses may not be activated until the start of the term. If you cannot locate your DL course in Canvas when the term starts, contact the professor. **On the first day of classes, log into your DL course to show your "attendance" because not doing so could result in your being dropped from the class for non-attendance.**

Professor contact info: Email Professor Loera-Ramirez at either: DLoera@mtsac.edu, through Student Detail Schedule or Canvas at MyMtSAC Portal.

Students must use their Mt. SAC e-mail account and be aware of course commitment and student expectations described at <http://www.mtsac.edu/instruction/learning/distlearn/>

To prepare for a successful online learning experience, see helpful short videos at <http://www.mtsac.edu/distancelearning/quiz/>

42760 Th 12:00pm - 2:05pm Arterburn, P 26D-3481
and arrange 2.25 hours Arterburn, P ONLINE

NOTE: CRN 42760 is a Hybrid Class taught partially online with Scheduled Meetings on Campus.

How to Begin Course: Log into Canvas through <http://myportal.mtsac.edu> and click on CRN for your DL course. **NOTE:** Some courses may not be activated until the start of the term. If you cannot locate your DL course in Canvas when the term starts, contact the professor. **On the first day of classes, log into your DL course to show your "attendance" because not doing so could result in your being dropped from the class for non-attendance.**

Professor contact info: Email Professor Arterburn at either: PArterburn@mtsac.edu, through Student Detail Schedule or Canvas at MyMtSAC Portal.

Students must use their Mt. SAC e-mail account and be aware of course commitment and student expectations described at <http://www.mtsac.edu/instruction/learning/distlearn/>

To prepare for a successful online learning experience, see helpful short videos at <http://www.mtsac.edu/distancelearning/quiz/>

42725 TThF 1:15pm - 2:30pm Enke, G 26A-3610
42750 F 1:30pm - 5:45pm Key Ketter, L 26A-1871
42846 F 1:30pm - 5:45pm Cushing, W 26A-3821
42751 MW 2:15pm - 4:20pm Holland, D 26A-3891
42752 MW 2:15pm - 4:20pm Chandler, G 26A-3620
42753 MW 2:15pm - 4:20pm Mc Kennon, A 26A-3610
42754 MW 2:15pm - 4:20pm Flores, C 26A-3680
42761 T 2:15pm - 4:20pm Bartman, S 26A-3821
and arrange 2.25 hours Bartman, S ONLINE

NOTE: CRN 42761 is a Hybrid Class taught partially online with Scheduled Meetings on Campus.

How to Begin Course: Log into Canvas through <http://myportal.mtsac.edu> and click on CRN for your DL course. **NOTE:** Some courses may not be activated until the start of the term. If you cannot locate your DL course in Canvas when the term starts, contact the professor. **On the first day of classes, log into your DL course to show your "attendance" because not doing so could result in your being dropped from the class for non-attendance.**

Professor contact info: Email Professor Bartman at either: SBartman@mtsac.edu, through Student Detail Schedule or Canvas at MyMtSAC Portal.

Students must use their Mt. SAC e-mail account and be aware of course commitment and student expectations described at <http://www.mtsac.edu/instruction/learning/distlearn/>

To prepare for a successful online learning experience, see helpful short videos at <http://www.mtsac.edu/distancelearning/quiz/>

42755 TTh 2:15pm - 4:20pm Straw, E 26A-3841
42756 TTh 2:15pm - 4:20pm Yoo, E 26D-G220

NOTE: No cost digital textbooks or textual materials used.

42757 TTh 2:15pm - 4:20pm Perez Gonzalez, J 26A-2610
43030 TTh 2:15pm - 4:20pm Zeledon, S 26A-3690
43052 TTh 2:15pm - 4:20pm Boehner-Staylor, M 26A-3620

44474 Th 2:15pm - 4:20pm Bartman, S 26A-3821
and arrange 2.25 hours Bartman, S ONLINE

NOTE: CRN 44474 is a Hybrid Class taught partially online with Scheduled Meetings on Campus.

How to Begin Course: Log into Canvas through <http://myportal.mtsac.edu> and click on CRN for your DL course. **NOTE:** Some courses may not be activated until the start of the term. If you cannot locate your DL course in Canvas when the term starts, contact the professor. **On the first day of classes, log into your DL course to show your "attendance" because not doing so could result in your being dropped from the class for non-attendance.**

Professor contact info: Email Professor Bartman at either: SBartman@mtsac.edu, through Student Detail Schedule or Canvas at MyMtSAC Portal.

Students must use their Mt. SAC e-mail account and be aware of course commitment and student expectations described at <http://www.mtsac.edu/instruction/learning/distlearn/>

To prepare for a successful online learning experience, see helpful short videos at <http://www.mtsac.edu/distancelearning/quiz/>

42758 MW 4:30pm - 6:35pm STAFF 26D-3481
42759 MW 4:30pm - 6:35pm Chandler, G 26A-3620
42763 MW 4:30pm - 6:35pm Holland, D 26A-3891
42764 MW 4:30pm - 6:35pm Hight, J 26A-3871
42762 TTh 4:30pm - 6:35pm Zeledon, S 26A-3690
42765 TTh 4:30pm - 6:35pm Straw, E 26A-3841
42805 TTh 4:30pm - 6:35pm Reichert, N 26A-3891
42814 TTh 4:30pm - 6:35pm Yoo, E 26D-G220

NOTE: No cost digital textbooks or textual materials used.

42823 TTh 4:30pm - 6:35pm Sanchez, C 26D-2210
43031 TTh 4:30pm - 6:35pm Perez Gonzalez, J 26A-2610
42827 MW 6:45pm - 8:50pm STAFF 26D-3481
42828 MW 6:45pm - 8:50pm Hight, J 26A-3871
42858 MW 6:45pm - 8:50pm Erickson, E 26A-3670
42859 TTh 6:45pm - 8:50pm Erickson, E 26A-3670
43006 TTh 6:45pm - 8:50pm Reichert, N 26A-3891
43007 TTh 6:45pm - 8:50pm Sanchez, C 26D-2210

■ ENGL 75 — Vocabulary Building 3.0 Units
Not Degree Applicable

(May be taken for option of Letter grade or Pass/NoPass)
Expands reading, writing, and speaking vocabularies through study of word formation.

44164 TTh 9:45am - 11:10am Farve, D 26A-3891

■ ENGL 90 — Accelerated Developmental Writing 5.0 Units
Not Degree Applicable

(May be taken for option of Letter grade or Pass/NoPass)

Prerequisite: Eligibility for ENGL 67

Advisory: Eligibility for READ 90 or eligibility for AMLA 33

Critical thinking skills, contextual analysis, and conventions of essay writing in preparation for college-level composition.

44172 MW 7:00am - 9:35am Weidner, N 26A-3670
44170 TTh 7:00am - 9:35am Myers, R 26A-1871
44171 TTh 9:45am - 12:20pm Myers, R 26A-1871
44167 MW 12:30pm - 3:05pm Danson, E 26A-2841
44168 TTh 12:30pm - 3:05pm Danson, E 26A-2841
44169 TTh 4:15pm - 6:50pm Dougherty, M 26A-3610

ENGLISH: LITERATURE

■ LIT 2 — Modern American Literature 3.0 Units
(C-ID ENGL 135) Degree Applicable, CSU, UC

Prerequisite: ENGL 1A

Emphasizes characteristic themes and forms of late 19th, 20th, and 21st century American literature.

42777 MW 8:00am - 9:25am Allende, K 26A-3680
42807 Th 7:00pm - 10:10pm STAFF 26A-3680

■ **LIT 3 — Multicultural American Literature** **3.0 Units**
Degree Applicable, CSU, UC

Prerequisite: Eligibility for ENGL 1A

Representative contributions of diverse groups to American literature and culture.

42778 TTh 9:45am - 11:10am Kordich, J 26A-3680

■ **LIT 6B — Survey of English Literature** **3.0 Units**
Degree Applicable, CSU, UC

Prerequisite: ENGL 1A

Major works from the late 18th century on to the Romantic Era through the Victorian and Modern periods to contemporary texts.

42782 TTh 12:00pm - 1:25pm Mageean, M 26A-3670

42783 T 7:00pm - 10:10pm Mc Cormick, E 26A-3680

■ **LIT 10 — Survey of Shakespeare** **3.0 Units**
Degree Applicable, CSU, UC

Prerequisite: ENGL 1A

Shakespeare's histories, tragedies, comedies, and selected sonnets within their historical and literary contexts.

42853 TTh 8:00am - 9:25am Hallsted, C 26D-3481

■ **LIT 11B — World Literature from 1650** **3.0 Units**
Degree Applicable, CSU, UC

Prerequisite: ENGL 1A

Works and ideas from 1650 through the 21st century emphasizing the thought and spirit of the ages in which they were written.

42775 TTh 9:45am - 11:10am Cannon, H 26D-3491

■ **LIT 15 — Introduction to Cinema** **3.0 Units**
Degree Applicable, CSU, UC

Prerequisite: ENGL 1A

Explores the broad range of human experience inherent in the study of film as art.

42839 F 9:00am - 12:10pm Piluso, R 26A-2620

42776 MW 9:45am - 11:10am Churchill, P 26D-3280

43014 T 7:00pm - 10:10pm Weidner, N 26A-3610

■ **LIT 20 — African American Literature** **3.0 Units**
Degree Applicable, CSU, UC

Prerequisite: ENGL 1A

Surveys African American writing of 18th-21st Centuries. Emphasizes oral traditions, protest literature, and major modern writers.

44174 TTh 12:00pm - 1:25pm Wright, J 26A-3841

■ **LIT 36 — Introduction to Mythology** **3.0 Units**
Degree Applicable, CSU, UC

Prerequisite: ENGL 1A

Major myths, including creation, fertility, and hero myths. Emphasis is on the Classical myths.

42779 MW 9:45am - 11:10am Whalen, M 26D-G220

43015 M 7:00pm - 10:10pm Zeledon, S 26A-3680

■ **LIT 40 — Children's Literature** **3.0 Units**
(C-ID ENGL 180) Degree Applicable, CSU

Prerequisite: ENGL 1A

Children's fiction and non-fiction books from around the world.

42780 TTh 12:00pm - 1:25pm Whalen, M 26B-3561

■ **LIT 47 — The Bible As Literature: New Testament** **3.0 Units**
Degree Applicable, CSU, UC

Prerequisite: ENGL 1A

Considers the Bible as a collection of literary texts and applies literary analysis to selected books of the New Testament.

44175 MW 12:00pm - 1:25pm Leader, J 21G-2

FAMILY AND CONSUMER STUDIES

■ **FCS 41 — Life Management** **3.0 Units**
Degree Applicable, CSU

Life skills for effective self-management including value clarification, goal setting, time management, and money management.

41245 MW 8:00am - 9:25am Robles, D 77-2080

40860 TTh 8:00am - 9:25am Amos, L 77-2080

44224 F 8:00am - 11:10am Schlesinger, C 77-2080

40861 MW 9:45am - 11:10am Robles, D 77-2080

40862 MW 11:30am - 12:55pm Engstrom, R 77-2080

40863 TTh 11:30am - 12:55pm Amos, L 77-2080

40864 MW 1:15pm - 2:40pm Engstrom, R 77-2080

44222 M 3:00pm - 6:10pm Engstrom, R 77-2080

44223 T 6:30pm - 9:40pm STAFF 77-2080

41186 W 6:30pm - 9:40pm Gonzalez, E 77-2080

41228 arrange 3.4 hours Fernandez, M ONLINE

NOTE:CRN 41228 is a Distance Learning Online Class.

How to Begin Course: Log into Canvas through <http://myportal.mtsac.edu> and click on CRN for your DL course. **NOTE:** Some courses may not be activated until the start of the term. If you cannot locate your DL course in Canvas when the term starts, contact the professor. **On the first day of classes, log into your DL course to show your "attendance" because not doing so could result in your being dropped from the class for non-attendance.**

Professor contact info: Email Professor Fernandez at either: MFernandez94@mtsac.edu, through Student Detail Schedule or Canvas at MyMtSAC Portal.

Students must use their Mt. SAC e-mail account and be aware of course commitment and student expectations described at <http://www.mtsac.edu/instruction/learning/distlearn/>

To prepare for a successful online learning experience, see helpful short videos at <http://www.mtsac.edu/distancelearning/quiz/>

41246 arrange 3.4 hours Amos, L ONLINE

NOTE:CRN 41246 is a Distance Learning Online Class.

How to Begin Course: Log into Canvas through <http://myportal.mtsac.edu> and click on CRN for your DL course. **NOTE:** Some courses may not be activated until the start of the term. If you cannot locate your DL course in Canvas when the term starts, contact the professor. **On the first day of classes, log into your DL course to show your "attendance" because not doing so could result in your being dropped from the class for non-attendance.**

Professor contact info: Email Professor Amos at either: LAmos1@mtsac.edu, through Student Detail Schedule or Canvas at MyMtSAC Portal.

Students must use their Mt. SAC e-mail account and be aware of course commitment and student expectations described at <http://www.mtsac.edu/instruction/learning/distlearn/>

To prepare for a successful online learning experience, see helpful short videos at <http://www.mtsac.edu/distancelearning/quiz/>

41270 arrange 3.4 hours Fernandez, M ONLINE

NOTE:CRN 41270 is a Distance Learning Online Class.

How to Begin Course: Log into Canvas through <http://myportal.mtsac.edu> and click on CRN for your DL course. **NOTE:** Some courses may not be activated until the start of the term. If you cannot locate your DL course in Canvas when the term starts, contact the professor. **On the first day of classes, log into your DL course to show your "attendance" because not doing so could result in your being dropped from the class for non-attendance.**

Professor contact info: Email Professor Fernandez at either: MFernandez94@mtsac.edu, through Student Detail Schedule or Canvas at MyMtSAC Portal.

Students must use their Mt. SAC e-mail account and be aware of course commitment and student expectations described at <http://www.mtsac.edu/instruction/learning/distlearn/>

To prepare for a successful online learning experience, see helpful short videos at <http://www.mtsac.edu/distancelearning/quiz/>

■ **FCS 80 — Personal Financial Planning** **3.0 Units**
Degree Applicable, CSU
Personal finance focusing on practical financial decision making. May not earn credit for both BUSA 71 and FCS 80.
40865 TTh 9:45am - 11:10am Amos, L 77-2080

■ **FCS 91 — Work Experience in Family and Consumer Sciences** **1.0 Unit**
Degree Applicable

(May be taken for Pass/No Pass Only)

Prerequisite: Compliance with work experience regulations as designated in the College Catalog

Provides Family and Consumer Science majors with job experience. 75 paid or 60 unpaid hours required for each unit of credit.

40866 arrange 4.7 hours Amos, L OCAM

NOTE: CRN 40866 Provides the student with on-the-job experience in an approved work site. A minimum of 75 paid hours or 60 non-paid hours per term is required for each unit of credit. Work experience placement is not guaranteed. Student must contact Career Services Specialist, Dawn Finley at dfinley@mtsac.edu by January 22, 2018

FASHION MERCHANDISING AND DESIGN

■ **FASH 8 — Introduction to Fashion** **3.0 Units**
Degree Applicable, CSU
Fashion industry, including raw materials, manufacturing, retailing, technology, world economics, globalization, and careers.

41033 TTh 8:00am - 9:25am STAFF 78-2195
41036 arrange 3.4 hours Espy, S ONLINE

NOTE: CRN 41036 is a Distance Learning Online Class.

How to Begin Course: Log into Canvas through <http://myportal.mtsac.edu> and click on CRN for your DL course. **NOTE:** Some courses may not be activated until the start of the term. If you cannot locate your DL course in Canvas when the term starts, contact the professor. **On the first day of classes, log into your DL course to show your "attendance" because not doing so could result in your being dropped from the class for non-attendance.**

Professor contact info: Email Professor Espy at either: sespy@mtsac.edu, through Student Detail Schedule or Canvas at MyMtSAC Portal.

Students must use their Mt. SAC e-mail account and be aware of course commitment and student expectations described at <http://www.mtsac.edu/instruction/learning/distlearn/>

To prepare for a successful online learning experience, see helpful short videos at <http://www.mtsac.edu/distancelearning/quiz/>

■ **FASH 10 — Clothing Construction I** **3.0 Units**
Degree Applicable, CSU
Essentials of industry standard apparel construction techniques using a variety of machines and equipment.

41035 Th 9:45am - 11:50am Davis, M 78-2185
and Th 12:00pm - 3:10pm Davis, M 78-2185
41034 T 12:30pm - 3:35pm Davis, M 78-2185
and T 3:45pm - 5:45pm Davis, M 78-2185
41037 MW 7:00pm - 8:25pm Davis, M 78-2185
and MW 8:35pm - 9:25pm Davis, M 78-2185

■ **FASH 12 — Clothing Construction II** **3.0 Units**
Degree Applicable, CSU

Prerequisite: FASH 10

Advanced industry construction techniques using overlock and single needle machines.

41229 TTh 7:00pm - 8:25pm Holinsworth, J 78-2185
and TTh 8:35pm - 9:25pm Holinsworth, J 78-2185

■ **FASH 14 — Dress, Culture, and Identity** **3.0 Units**
Degree Applicable, CSU

The interrelatedness of socio-psychological, economic, cultural, and influences on dress, and fashion in historical perspective.

41164 MW 9:45am - 11:10am Espy, S 78-2150
41165 T 7:00pm - 10:10pm Fueger, M 78-2150

■ **FASH 15 — Aesthetic Design in Fashion** **3.0 Units**
Degree Applicable, CSU

Prerequisite: FASH 25

Design principles and influences in apparel selection and fashion design.
41191 F 8:00am - 11:10am STAFF 78-2150

■ **FASH 17 — Textiles** **3.0 Units**
Degree Applicable, CSU, UC

Examines natural and manufactured knits and woven fabrics and factors which determine suitability for end use.

41140 T 3:30pm - 6:40pm Espy, S 78-2160

■ **FASH 21 — Patternmaking I** **3.0 Units**
Degree Applicable, CSU

Prerequisite: FASH 10

Theory and application of basic flat patternmaking techniques to create garment designs using industry standards.

41038 W 12:30pm - 2:35pm Davis, M 78-2160
and F 2:40pm - 5:50pm Davis, M 78-2160

■ **FASH 22 — Fashion Design By Draping** **3.0 Units**
Degree Applicable

Prerequisite: FASH 10

Advisory: FASH 21

Three dimensional dress design through draping fabrics directly to a dress form.

41039 T 9:45am - 11:50am Holinsworth, J 78-2160
and T 12:00pm - 3:10pm Holinsworth, J 78-2160

■ **FASH 25 — Fashion Computer-Assisted Drawing** **3.0 Units**
Degree Applicable, CSU

Advisory: FASH 10

Technical fashion drawing techniques using Adobe Illustrator and Photoshop

41040 M 12:30pm - 2:35pm Davis, M 78-2150
and M 2:40pm - 5:50pm Davis, M 78-2150

■ **FASH 62 — Retail Buying and Merchandising** **3.0 Units**
Degree Applicable, CSU

Advisory: MATH 51

Principles and practices used in the retail buying and merchandising environment.

41041 T 12:00pm - 3:10pm Espy, S 78-2150

■ **FASH 63 — Fashion Promotion** **3.0 Units**
Degree Applicable, CSU

Principles and techniques of advertising and promoting apparel wholesale and retail products.

41042 MW 8:00am - 9:25am Espy, S 78-2195

■ **FASH 66 — Visual Merchandising Display** **3.0 Units**
Degree Applicable, CSU

Prerequisite: FASH 25 or ARTC 140

Design principles, color theory, space and lighting in relation to visual merchandising display areas.

44196 F 11:30am - 2:40pm STAFF 78-2150
and F 3:00pm - 5:05pm STAFF 78-2150

■ **FASH 81 — Work Experience in Fashion Merchandising and Retail** **1.0 Unit**

(May be taken for Pass/No Pass Only)

Prerequisite: FASH 8

Provides fashion merchandising students with actual on-the-job experience in an approved work site that is related to fashion.

44373 arrange 4.7 hours Espy, S OCAM

NOTE: CRN 44373 Provides the student with on-the-job experience in an approved work site. A minimum of 75 paid hours or 60 non-paid hours per term is required for each unit of credit. Work experience placement is not guaranteed. Student must contact Career Services Specialist, Dawn Finley at dfinley@mtsac.edu by January 22, 2018

FIRE TECHNOLOGY

■ FIRE 1 — Fire Protection Organization **3.0 Units**
Degree Applicable, CSU

Careers in fire protection, history of fire protection, public, private and fire department functions, and fire behaviors.

41367	W	8:00am - 11:10am	Lazar, E	28B-210
41366	M	11:30am - 2:40pm	Mosack, R	28B-210
41368	T	3:00pm - 6:10pm	Mosack, R	28B-210

■ FIRE 2 — Fire Prevention Technology **3.0 Units**
Degree Applicable, CSU

History of fire prevention, including codes, ID and hazard correction, investigation, and public safety education.

41371	Th	8:00am - 11:10am	Genovese, R	28B-210
41370	W	3:00pm - 6:10pm	Lazar, E	28B-210
41544		arrange 3.38 hours	Shull, S	ONLINE

NOTE: CRN 41544 Is a Distant Learning Class.

How to Begin Course: Log into Canvas through <http://myportal.msac.edu> and click CRN for you DL course. **NOTE:** Some courses may not be activated until the start of the term. If you cannot locate your DL course in Canvas when the term starts, contact the professor. On the first day of classes, log into your DL course to show your "attendance" because not doing so could result in your being dropped from the class for non-attendance.

Professor contact info: Email Chief Stephen Shull at either: sshull@mt-sac.edu, through Student Detail Schedule or Canvas at MyMtSAC Portal.

Students must use their Mt. SAC e-mail account and be aware of course commitment and student expectations described at <http://www.mtsac.edu/instruction/learning/distlearn/> To prepare for a successful online learning experience, see helpful short videos <http://www.mtsac.edu/distancelearning/quiz/>

■ FIRE 3 — Fire Protection Equipment and Systems **3.0 Units**
Degree Applicable, CSU

Advisory: FIRE 1

Portable fire extinguishing equipment, sprinklers, water supply, alarms, and detection systems.

41372	Th	11:30am - 2:40pm	Genovese, R	28B-210
41373	T	3:00pm - 6:10pm	Pock, R	28B-203

■ FIRE 4 — Building Construction for Fire Protection **3.0 Units**
Degree Applicable, CSU

Advisory: FIRE 1

Building construction and fire code safety relating to pre-planning, engineering, inspections and fire ground operations.

41374	T	8:00am - 11:10am	Lopez, R	28B-203
41375	W	8:00am - 11:10am	Dominick, S	28B-203
41559	M	11:30am - 2:40pm	Petersen, J	28B-203

■ FIRE 5 — Fire Behavior and Combustion **3.0 Units**
Degree Applicable, CSU

Advisory: FIRE 1

How and why fires start, spread, and are controlled; fire chemistry and physics; extinguishing agents and fire control techniques.

41377	Th	11:30am - 2:40pm	Huffman, D	28B-203
41376	W	3:00pm - 6:10pm	Huffman, D	28B-203

■ FIRE 7 — Fire Fighting Tactics and Strategy **3.0 Units**
Degree Applicable, CSU

Advisory: FIRE 1 or equivalent taken prior

Principles of fire control through utilization of basic firefighting strategies and tactics.

41380	Th	3:00pm - 6:10pm	Genovese, R	28B-210
-------	----	-----------------	-------------	---------

■ FIRE 9 — Fire Hydraulics **3.0 Units**
Degree Applicable, CSU

Advisory: FIRE 1 or equivalent taken prior and eligibility for MATH 51

Mathematics, hydraulic laws, and formulas as applied to fire service.

44383	T	11:30am - 2:40pm	Lopez, R	28B-203
-------	---	------------------	----------	---------

■ FIRE 12 — Wildland Fire Control **4.5 Units**
Degree Applicable, CSU

Advisory: Eligibility for ENGL 68

Addresses wildland fire behavior, safety, strategy, tactics, and operations in the wildland urban interface. Field trip required.

41369	S	8:00am - 11:50am	Burrill, B	28B-210
	and S	1:00pm - 3:15pm	Burrill, B	28B-210
		and arrange 1.4 hours	Burrill, B	

10 Weeks, Week beginning 02/26/2018 ending 05/06/2018

■ FIRE 13 — Principles of Fire and Emergency Services Safety and Survival **3.0 Units**

Advisory: FIRE 1 Degree Applicable, CSU

Fire Technology principles. History of the National Firefighter Life Safety Initiative and need for cultural and behavioral change

41378	Th	8:00am - 11:10am	Lazar, R	28B-208
41379	W	11:30am - 2:40pm	Lazar, E	28B-208
41545		arrange 3.38 hours	Hirsch, J	ONLINE

■ FIRE 86 — Basic Fire Academy **14.5 Units**
Degree Applicable

Prerequisite: FIRE 1 through 5 and FIRE 13 or equivalent, KIN 50, approved EMT course completion, and either KINF 51 or KINF 52 (or equivalent).

Corequisite: KINF 53

Standard fire department apparatus and equipment, salvage covers and fire extinguishment techniques.

41381		arrange 9 hours	Shull, S	CVIFD
		and arrange 25.53 hours	Hirsch, J	CVIFD

14 Weeks, Week beginning 02/26/2018 ending 06/03/2018

■ FIRE 93 — Firefighter 1 Skills Review and Testing **1.0 Unit**
Not Degree Applicable

(May be taken for Pass/No Pass Only)

Prerequisite: FIRE-86 Basic Fire Academy course completion

Review of skills learned in the basic fire academy, in conjunction with the National Firefighter 1 Certification exam.

41561		arrange 40.00 hours	Hirsch, J	28B
-------	--	---------------------	-----------	-----

1 Weeks, Week beginning 06/04/2018 ending 06/10/2018

■ FIRE 96 — Work Experience Fire Science **1.0 Unit**
Not Degree Applicable

(May be taken for Pass/No Pass Only)

Prerequisite: Compliance with Work Experience regulations as designated in the College Catalog. Completion of a minimum of 12 units in Fire Science.

On-the-job experience at an approved work site. 75 paid or 60 non-paid hours required for each unit of credit.

41490		arrange 4.7 hours	Mosack, R	28B
-------	--	-------------------	-----------	-----

■ FIRE 96 — Work Experience Fire Science **2.0 Units**
(May be taken for Pass/No Pass Only) Not Degree Applicable

Prerequisite: Compliance with Work Experience regulations as designated in the College Catalog. Completion of a minimum of 12 units in Fire Science.

On-the-job experience at an approved work site. 75 paid or 60 non-paid hours required for each unit of credit.

41491		arrange 9.4 hours	Mosack, R	28B
-------	--	-------------------	-----------	-----

FRENCH

■ FRCH 1 — Elementary French **4.0 Units**
Degree Applicable, CSU, UC

Beginning course for students without prior exposure to French.

42921	MW	7:30am - 9:35am	Nabulsi, A	26D-3471
42922	TTh	7:30am - 9:35am	Anglin, M	17-9
42923	F	9:00am - 1:15pm	Merino, M	26D-3471
42924	MW	9:45am - 11:50am	Gard, A	26D-3471
42925	TTh	9:45am - 11:50am	La Valle Shepston, A	21G-2
42926	MW	12:00pm - 2:05pm	Halabi, S	26D-3471
42927	TTh	12:00pm - 2:05pm	La Valle Shepston, A	21G-2
42928	TTh	4:30pm - 6:35pm	Nguyen, M	26D-3471
42929	MW	6:45pm - 8:50pm	Gard, A	26B-3551
44256	TTh	6:45pm - 8:50pm	Nguyen, M	26D-3471

FRCH 2 — Continuing Elementary French **4.0 Units**

Degree Applicable, CSU, UC

Prerequisite: FRCH 1 or equivalent

Further development of elementary skills in French. Explores French culture.

42930	TTh	9:45am - 11:50am	Anglin, M	17-9
42931	MW	6:45pm - 8:50pm	Erturk, F	26D-3471

FRCH 3 — Intermediate French **4.0 Units**

Degree Applicable, CSU, UC

(May be taken for option of Letter grade or Pass/NoPass)

Prerequisite: FRCH 2 or equivalent

Expansion of vocabulary and structural components. Explores French culture.

42932	TTh	12:00pm - 2:05pm	Halabi, S	26D-3471
-------	-----	------------------	-----------	----------

FRCH 4 — Continuing Intermediate French **4.0 Units**

Degree Applicable, CSU, UC

(May be taken for option of Letter grade or Pass/NoPass)

Prerequisite: FRCH 3

Continued development of intermediate-level proficiency in French. Explores French culture.

43046	TTh	9:45am - 11:50am	Halabi, S	26D-3471
-------	-----	------------------	-----------	----------

FRCH 60 — French Culture Through Cinema **3.0 Units**

Degree Applicable, CSU, UC

(May be taken for option of Letter grade or Pass/NoPass)

French culture and history as presented in classic and recent subtitled French movies. Lectures and class discussions in English.

42933	M	3:00pm - 6:10pm	Halabi, S	26A-1821
44080	T	6:30pm - 9:40pm	Merino, M	26D-2491

GEOGRAPHY
GEOG 1 — Physical Geography **3.0 Units**

(C-ID GEOG 110)

Degree Applicable, CSU, UC

Prerequisite: Eligibility for ENGL 1A

Study of the natural processes creating the Earth's physical environments: weather, climate, landforms, soils, and ecosystems.

43018	MW	11:30am - 12:55pm	STAFF	26D-3270
42339	TTh	1:15pm - 2:40pm	Bayle, M	26D-3270
42340	TTh	3:00pm - 4:25pm	Bayle, M	26D-3270
42341	T	7:00pm - 10:10pm	Pietsch, E	26D-3270
42455	arrange	3.4 hours	Golden, D	ONLINE

NOTE: CRN 42455 is a Distance Learning Online Class.

How to Begin Course: Log into Moodlerooms through <http://myportal.mtsac.edu> and click on CRN for your DL course. **NOTE:** Some courses may not be activated until the start of the term. If you cannot locate your DL course in Moodlerooms when the term starts, contact the professor. **On the first day of classes, log into your DL course to show your "attendance" because not doing so could result in your being dropped from the class for non-attendance.**

Professor contact info: Email Professor Golden at either: DGolden@mtsac.edu, through Student Detail Schedule or Moodlerooms at MyMtSAC Portal.

Students must use their Mt. SAC e-mail account and be aware of course commitment and student expectations described at <http://www.mtsac.edu/instruction/learning/distlearn/>

To prepare for a successful online learning experience, see helpful short videos at <http://www.mtsac.edu/distancelearning/quiz/>

42456 arrange 3.4 hours Golden, D ONLINE

NOTE: CRN 42456 is a Distance Learning Online Class.

How to Begin Course: Log into Moodlerooms through <http://myportal.mtsac.edu> and click on CRN for your DL course. **NOTE:** Some courses may not be activated until the start of the term. If you cannot locate your DL course in Moodlerooms when the term starts, contact the professor. **On the first day of classes, log into your DL course to show your "attendance" because not doing so could result in your being dropped from the class for non-attendance.**

Professor contact info: Email Professor Golden at either: DGolden@mtsac.edu, through Student Detail Schedule or Moodlerooms at MyMtSAC Portal.

Students must use their Mt. SAC e-mail account and be aware of course commitment and student expectations described at <http://www.mtsac.edu/instruction/learning/distlearn/>

To prepare for a successful online learning experience, see helpful short videos at <http://www.mtsac.edu/distancelearning/quiz/>

42593 arrange 3.4 hours Golden, D ONLINE

NOTE: CRN 42593 is a Distance Learning Online Class.

How to Begin Course: Log into Moodlerooms through <http://myportal.mtsac.edu> and click on CRN for your DL course. **NOTE:** Some courses may not be activated until the start of the term. If you cannot locate your DL course in Moodlerooms when the term starts, contact the professor. **On the first day of classes, log into your DL course to show your "attendance" because not doing so could result in your being dropped from the class for non-attendance.**

Professor contact info: Email Professor Golden at either: DGolden@mtsac.edu, through Student Detail Schedule or Moodlerooms at MyMtSAC Portal.

Students must use their Mt. SAC e-mail account and be aware of course commitment and student expectations described at <http://www.mtsac.edu/instruction/learning/distlearn/>

To prepare for a successful online learning experience, see helpful short videos at <http://www.mtsac.edu/distancelearning/quiz/>

44177 arrange 3.4 hours Lobb, E ONLINE

NOTE: CRN 44177 is a Distance Learning Online Class.

How to Begin Course: Log into Canvas through <http://myportal.mtsac.edu> and click on CRN for your DL course. **NOTE:** Some courses may not be activated until the start of the term. If you cannot locate your DL course in Canvas when the term starts, contact the professor. **On the first day of classes, log into your DL course to show your "attendance" because not doing so could result in your being dropped from the class for non-attendance.**

Professor contact info: Email Professor Lobb at either: ELobb@mtsac.edu, through Student Detail Schedule or Canvas at MyMtSAC Portal.

Students must use their Mt. SAC e-mail account and be aware of course commitment and student expectations described at <http://www.mtsac.edu/instruction/learning/distlearn/>

To prepare for a successful online learning experience, see helpful short videos at <http://www.mtsac.edu/distancelearning/quiz/>

GEOG 1L — Physical Geography Laboratory **1.0 Unit**

(C-ID GEOG 111)

Degree Applicable, CSU, UC

*Corequisite: GEOG 1 or GEOG 1H (May have been taken previously)**Advisory: MATH 50*

Geographical observations, experiments and demonstrations in a lab setting to explore natural earth processes and systems.

43019	M	1:15pm - 4:20pm	Prajapati, N	26D-3270
-------	---	-----------------	--------------	----------

■ GEOG 2 — Human Geography **3.0 Units**
(C-ID GEOG 120) Degree Applicable, CSU, UC

Prerequisite: Eligibility for ENGL 1A

Human geography with emphasis on critical areas of inquiry, research, and the interconnections of place and process.

43037 TTh 9:45am - 11:10am Lobb, E 26D-3270
42457 arrange 6.75 hours Lobb, E ONLINE

8 Weeks, Week beginning 02/26/2018 ending 04/22/2018

NOTE: CRN 42457 is a Distance Learning Online Class.

How to Begin Course: Log into Canvas through <http://myportal.mtsac.edu> and click on CRN for your DL course. **NOTE:** Some courses may not be activated until the start of the term. If you cannot locate your DL course in Canvas when the term starts, contact the professor. **On the first day of classes, log into your DL course to show your "attendance" because not doing so could result in your being dropped from the class for non-attendance.**

Professor contact info: Email Professor Lobb at either: ELobb@mtsac.edu, through Student Detail Schedule or Canvas at MyMtSAC Portal.

Students must use their Mt. SAC e-mail account and be aware of course commitment and student expectations described at <http://www.mtsac.edu/instruction/learning/distlearn/>

To prepare for a successful online learning experience, see helpful short videos at <http://www.mtsac.edu/distancelearning/quiz/>

42458 arrange 3.4 hours Lobb, E ONLINE

NOTE: CRN 42458 is a Distance Learning Online Class.

How to Begin Course: Log into Canvas through <http://myportal.mtsac.edu> and click on CRN for your DL course. **NOTE:** Some courses may not be activated until the start of the term. If you cannot locate your DL course in Canvas when the term starts, contact the professor. **On the first day of classes, log into your DL course to show your "attendance" because not doing so could result in your being dropped from the class for non-attendance.**

Professor contact info: Email Professor Lobb at either: ELobb@mtsac.edu, through Student Detail Schedule or Canvas at MyMtSAC Portal.

Students must use their Mt. SAC e-mail account and be aware of course commitment and student expectations described at <http://www.mtsac.edu/instruction/learning/distlearn/>

To prepare for a successful online learning experience, see helpful short videos at <http://www.mtsac.edu/distancelearning/quiz/>

■ GEOG 8 — The Urban World **3.0 Units**
Degree Applicable, CSU, UC

(May be taken for option of Letter grade or Pass/NoPass)

Geographical analysis of past and current patterns of world urbanization. Off-campus assignments are required.

43038 TTh 11:30am - 12:55pm Lobb, E 26D-3270

■ GEOG 10 — Introduction to Geographic Information Systems **3.0 Units**

(C-ID GEOG 155) Degree Applicable, CSU, UC

Advisory: Eligibility for ENGL 68

Principles of acquiring, implementing, and analyzing spatial data with an emphasis on map design.

44179 F 8:00am - 10:05am Aronna, A 28B-301B
and F 11:30am - 2:40pm Aronna, A 28B-301B

■ GEOG 30 — Geography of California **3.0 Units**
(C-ID GEOG 140) Degree Applicable, CSU, UC

Prerequisite: Eligibility for ENGL 1A

California's physiographic regional patterns of population, settlement, economics, transportation, and trade. Field trip required.

42342 MW 9:45am - 11:10am Prajapati, N 26D-3270

GEOLOGY

■ GEOL 1 — Physical Geology **4.0 Units**
Degree Applicable, CSU, UC

Prerequisite: Eligibility for MATH 51

Minerals, rocks, volcanoes, earthquakes, and landscapes. Required field trips may involve overnight camping.

41898 M 9:45am - 12:55pm Mrofka, D 60-1512
and W 9:45am - 12:55pm Mrofka, D 60-1512
41899 T 11:30am - 2:40pm Boryta, M 60-1512
and Th 11:30am - 2:40pm Boryta, M 60-1512
41994 M 1:15pm - 4:25pm Walker, R 60-1512
and W 1:15pm - 4:25pm Walker, R 60-1512
43375 T 3:00pm - 6:10pm Lackey, H 60-1512
and Th 3:00pm - 6:10pm Lackey, H 60-1512

■ GEOL 2 — Historical Geology **4.0 Units**
Degree Applicable, CSU, UC

Prerequisite: GEOL 1 or GEOL 8L

Tectonic, biologic and climatic development of the Earth system. Required field trips may involve overnight camping.

41959 M 9:45am - 12:55pm Lackey, H 60-1515
and W 9:45am - 12:55pm Lackey, H 60-1515

■ GEOL 7 — Geology of California **3.0 Units**
Degree Applicable, CSU, UC

Natural provinces of California. Required field trips may involve overnight camping.

41995 TTh 8:00am - 9:25am Boryta, M 11-2115

■ GEOL 8 — Earth Science **3.0 Units**
Degree Applicable, CSU, UC

Fundamentals of geology, oceanography, meteorology, and astronomy.

Field trips required. Take with GEOL 8L for lecture/lab credit.

41900 MW 8:00am - 9:25am Neves, D 11-2324
41901 TTh 8:00am - 9:25am Kingsbury, S 60-1515

NOTE: GEOL 8 (CRN 41901) is linked to GEOL 8L (CRN 41906). If you want to register for CRN 41901 you must enter both CRNS (41901 and 41906) in the registration screen. Please call the Natural Sciences Division at (909) 274-4425 if you have any questions.

41902 F 9:00am - 12:10pm Fair, C 11-2324
41904 MW 9:45am - 11:10am Neves, D 11-2324
41905 TTh 9:45am - 11:10am Aranda, A 11-2324
41924 MW 11:30am - 12:55pm Neves, D 11-2324
41957 TTh 11:30am - 12:55pm Ohare, D 11-2324
43378 M 1:15pm - 4:25pm STAFF 11-2324
41988 TTh 1:15pm - 2:40pm Ohare, D 11-2324
43379 TTh 3:00pm - 4:25pm Mata, S 11-2324
43380 M 6:30pm - 9:40pm STAFF 11-2324
43382 W 6:30pm - 9:40pm Fair, C 11-2324
43381 Th 6:30pm - 9:40pm Roberts, C 11-2324
41903 S 9:00am - 12:10pm Grubb, B 60-1515

■ GEOL 8H — Earth Science - Honors **3.0 Units**
Degree Applicable, CSU, UC

Prerequisite: Acceptance into the Honors Program

Fundamentals of geology, oceanography, meteorology, and astronomy.

Field trips are required.

43383 MW 8:00am - 9:25am Mrofka, D 60-1515

■ GEOL 8L — Earth Science Laboratory **1.0 Unit**

Degree Applicable, CSU, UC

Corequisite: GEOL 8 or GEOL 8H (May have been taken previously)

Laboratory applications and problem-solving in geology, oceanography, meteorology, and astronomy.

41906 TTh 9:45am - 11:10am Kingsbury, S 60-1515

NOTE: GEOL 8L (CRN 41906) is linked to GEOL 8 (CRN 41901). If you want to register for CRN 41906 you must enter both CRNS (41906 and 41901) in the registration screen. Please call the Natural Sciences Division at (909) 274-4425 if you have any questions.

41907 Th 11:30am - 2:40pm Kingsbury, S 60-1515

41909 W 1:15pm - 4:25pm Smith, L 60-1515

41910 T 3:00pm - 6:10pm Mrofka, D 60-1515

41927 Th 3:00pm - 6:10pm Hughes, R 60-1515

42008 T 6:30pm - 9:40pm Mata, S 60-1515

41908 S 1:00pm - 4:10pm Grubb, B 60-1515

■ GEOL 9 — Environmental Geology **3.0 Units**

Degree Applicable, CSU, UC

Advisory: ENGL 1A

Human interactions with the geological environment for non-science majors. Field trips required.

41911 TTh 11:30am - 12:55pm STAFF 61-1420

41989 TTh 1:15pm - 2:40pm Aranda, A 61-1420

41990 W 1:15pm - 4:25pm Anders, T 61-1420

43384 MW 6:30pm - 7:55pm STAFF 11-2115**43385 MW 8:15pm - 9:40pm STAFF 11-2115****■ GEOL 10 — Natural Disasters** **3.0 Units**

Degree Applicable, CSU, UC

A survey of the hazards faced by humans from the natural environment.

Field trips required.

41912 MW 8:00am - 9:25am Webb, C 11-2209

41913 MW 9:45am - 11:10am Webb, C 11-2209

41956 T 6:30pm - 9:40pm STAFF 11-2324**41996 Th 6:30pm - 9:40pm Mata, S 60-1512****■ GEOL 24 — Geologic Field Studies: Central California** **4.0 Units**

Degree Applicable, CSU

Field studies of selected Central California geological provinces. Overnight field trips with substantial hiking required.

43377 T 11:30am - 1:35pm Walker, R 60-1515

and T 1:50pm - 2:40pm Mrofka, D 60-1515

and arrange 2.3 hours Mrofka, D

■ GEOL 29 — Special Topics in Field Geology **3.0 Units**

Degree Applicable, CSU

Advisory: GEOL 1 or GEOL 8

Field studies of selected geologic provinces and regions. Extended overnight field trips, camping, and strenuous hiking required.

42014 M 4:30pm - 7:40pm STAFF 60-1512**and M 4:30pm - 7:40pm STAFF 60-1512****and M 4:30pm - 7:40pm STAFF 60-1512****and M 4:30pm - 7:40pm STAFF 60-1512****and M 4:30pm - 7:40pm STAFF 60-1512****and arrange 6.8 hours STAFF OCAM****NOTE:** Extended overnight field trips, camping, and strenuous hiking required.**GERMAN****■ GERM 1 — Elementary German** **4.0 Units**

Degree Applicable, CSU, UC

For students new to German, develops the ability to converse, read, and write in German. Includes cultural component.

42934 MW 7:30am - 9:35am Smith, D 40-133

42936 TTh 2:15pm - 4:20pm Voss, M 17-9

44081 MW 4:30pm - 6:35pm Tsai, J 66-269**42937 TTh 6:45pm - 8:50pm Tsai, J 26B-3551****■ GERM 2 — Continuing Elementary German** **4.0 Units**

Degree Applicable, CSU, UC

Prerequisite: GERM 1

Further development of conversational reading and writing skills in German.

42938 MW 9:45am - 11:50am Smith, D 40-133

■ GERM 3 — Intermediate German **4.0 Units**

Degree Applicable, CSU, UC

Prerequisite: GERM 2

Communicative proficiency in German and exploration of Germanic culture.

44086 TTh 12:00pm - 2:05pm Voss, M 17-9

HISTORY**■ HIST 1 — History of the United States** **3.0 Units**

Degree Applicable, CSU, UC

Prerequisite: Eligibility for ENGL 68

History of the United States from Native American and colonial times to present. History majors should take History 7 and 8.

43395 MW 8:00am - 9:25am Stanfield, A 26D-G210

43396 MW 8:00am - 9:25am Jones, W 26A-1831

43397 MW 8:00am - 9:25am Melton, J 26A-1811

43398 TTh 8:00am - 9:25am Carlson, F 40-131

43399 TTh 8:00am - 9:25am Geary, K 26A-1831

43400 TTh 8:00am - 9:25am Hunt, R 26A-1821

43401 F 8:00am - 11:10am Hoffman, H 26A-1821

43402 F 8:30am - 11:40am Chavez, R 26D-2421

43403 MW 9:45am - 11:10am Hunt, R 40-121

43404 MW 9:45am - 11:10am Stanfield, A 26D-G210

43405 MW 9:45am - 11:10am Frickert, A 26D-2421

43406 MW 9:45am - 11:10am Melton, J 26A-1811

43407 TTh 9:45am - 11:10am Carlson, F 40-131

43408 TTh 9:45am - 11:10am Kremer, A 40-133

43409 MW 11:30am - 12:55pm Browne, E 26A-1811

43410 MW 11:30am - 12:55pm Hunt, R 40-121

43411 TTh 11:30am - 12:55pm Browne, E 26A-1821

43412 TTh 11:30am - 12:55pm Geary, K 18-17

43413 F 11:30am - 2:40pm Earhart, K 26D-G431

43414 F 12:00pm - 3:10pm Chavez, R 26D-2421

43415 MW 1:15pm - 2:40pm Frickert, A 26D-2421

43416 MW 1:15pm - 2:40pm Meza, J 26A-1811

43417 MW 1:15pm - 2:40pm STAFF 26D-G290

43418 TTh 1:15pm - 2:40pm Geary, K 18-17

43419 TTh 1:15pm - 2:40pm Okonyan, D 26D-G210

43420 F 1:15pm - 4:25pm Tellez, A 26A-1831

43421 MW 3:00pm - 4:25pm Meza, J 26A-1811

43422 MW 3:00pm - 4:25pm Browne, E 18D-1101

43423 TTh 3:00pm - 4:25pm Frickert, A 26D-2421

43424 TTh 3:00pm - 4:25pm Lamphier, P 40-133

NOTE: No cost digital textbooks or textual materials used.

43425 TTh 3:00pm - 4:25pm Okonyan, D 26D-G411

43426 MW 5:15pm - 6:40pm Meza, J 26A-1811**43428 T 5:15pm - 8:25pm Haines, A 26A-1821****43427 TTh 5:15pm - 6:40pm Evanshine, S 26A-1811****43430 M 7:00pm - 10:10pm Melo, F 26D-G431****43432 T 7:00pm - 10:10pm Welch, R 26D-G431****43429 TTh 7:00pm - 8:25pm Evanshine, S 26A-1811****43431 W 7:00pm - 10:10pm Hajialiakbar, L 26A-1821****43433 Th 7:00pm - 10:10pm Page, R 26A-1831**

44467 arrange 3.4 hours Menzing, T ONLINE
NOTE: CRN 44467 is a Distance Learning Online Class.

How to Begin Course: Log into Canvas through <http://myportal.mtsac.edu> and click on CRN for your DL course. **NOTE:** Some courses may not be activated until the start of the term. If you cannot locate your DL course in Canvas when the term starts, contact the professor. **On the first day of classes, log into your DL course to show your "attendance" because not doing so could result in your being dropped from the class for non-attendance.**

Professor contact info: Email Professor Menzing at either: TMenzing@mtsac.edu, through Student Detail Schedule or Canvas at MyMt-SAC Portal.

Students must use their Mt. SAC e-mail account and be aware of course commitment and student expectations described at <http://www.mtsac.edu/instruction/learning/distlearn/>

To prepare for a successful online learning experience, see helpful short videos at <http://www.mtsac.edu/distancelearning/quiz/>

44468 arrange 3.4 hours Menzing, T ONLINE
NOTE: CRN 44468 is a Distance Learning Online Class.

How to Begin Course: Log into Canvas through <http://myportal.mtsac.edu> and click on CRN for your DL course. **NOTE:** Some courses may not be activated until the start of the term. If you cannot locate your DL course in Canvas when the term starts, contact the professor. **On the first day of classes, log into your DL course to show your "attendance" because not doing so could result in your being dropped from the class for non-attendance.**

Professor contact info: Email Professor Menzing at either: TMenzing@mtsac.edu, through Student Detail Schedule or Canvas at MyMt-SAC Portal.

Students must use their Mt. SAC e-mail account and be aware of course commitment and student expectations described at <http://www.mtsac.edu/instruction/learning/distlearn/>

To prepare for a successful online learning experience, see helpful short videos at <http://www.mtsac.edu/distancelearning/quiz/>

■ **HIST 3 — World History: Prehistoric to Early Modern** 3.0 Units
 Degree Applicable, CSU, UC

Prerequisite: Eligibility for ENGL 1A

Human societies from their origins to the Early Modern period from a global and comparative perspective.

43434	TTh	9:45am - 11:10am	Grimstad, A	18D-1101
44472	MW	11:30am - 12:55pm	Frickert, A	26D-2421
43435	TTh	1:15pm - 2:40pm	Grimstad, A	26A-1811

■ **HIST 4 — World History: Early Modern to the Present** 3.0 Units
 (C-ID HIST 160) Degree Applicable, CSU, UC

Prerequisite: Eligibility for ENGL 1A

Social, political, economic, and cultural changes during the modern period from a global and comparative perspective.

43436	MW	9:45am - 11:10am	Grimstad, A	18D-1101
-------	----	------------------	-------------	----------

■ **HIST 4H — World History: Early Modern to the Present - Honors** 3.0 Units
 (C-ID HIST 160) Degree Applicable, CSU, UC

Prerequisite: Acceptance into the Honors Program

Social, political, economic, and cultural changes of modern period. Honors course. Credit not given for both HIST 4 and HIST 4H.

43438	MW	11:30am - 12:55pm	Grimstad, A	18D-1101
-------	----	-------------------	-------------	----------

■ **HIST 7 — History of the United States to 1877** 3.0 Units
 Degree Applicable, CSU, UC

Prerequisite: Eligibility for ENGL 1A

U.S. History to 1877. Examines social, economic, political, intellectual, military themes and patterns of U.S. development.

43439	TTh	8:00am - 9:25am	Jones, W	26D-G431
43440	F	8:00am - 11:10am	Earhart, K	26D-G431
43441	MW	9:45am - 11:10am	Earhart, K	26D-G431
43442	TTh	9:45am - 11:10am	Jones, W	26D-G431
43443	TTh	11:30am - 12:55pm	Carlson, F	40-131
43444	MW	1:15pm - 2:40pm	Hoffman, H	26A-1821
43445	W	7:00pm - 10:10pm	Melo, F	26D-G431

■ **HIST 8 — History of the United States from 1865** 3.0 Units
 Degree Applicable, CSU, UC

Prerequisite: Eligibility for ENGL 1A

U.S. history from 1865. Examines social, economic, political, intellectual, and military themes and patterns of U.S. development.

43446	MW	8:00am - 9:25am	Earhart, K	26D-G431
43447	TTh	8:30am - 9:55am	Chavez, R	26A-1811
43448	MW	9:45am - 11:10am	Jones, W	26A-1831
43449	TTh	9:45am - 11:10am	Cannon, K	26A-1821
43450	F	9:45am - 12:55pm	Tellez, A	26A-1831
43451	MW	10:15am - 11:40am	Chavez, R	21C-1
43452	MW	11:30am - 12:55pm	Jones, W	26A-1831
43453	T	7:00pm - 10:10pm	Page, R	26A-1831

■ **HIST 8H — History of the United States from 1865 - Honors** 3.0 Units
 Degree Applicable, CSU, UC

Prerequisite: Acceptance into the Honors Program

Honors course designed to provide an enriched experience. May not receive credit for both HIST 8 and HIST 8H.

43454	TTh	1:15pm - 2:40pm	Cannon, K	26D-G431
-------	-----	-----------------	-----------	----------

■ **HIST 11 — History of Modern Asia** 3.0 Units
 Degree Applicable, CSU, UC

Prerequisite: Eligibility for ENGL 68

History of East, South, and Southeast Asia from the early modern period to the present.

43455	TTh	9:45am - 11:10am	Frickert, A	26D-2421
43456	TTh	1:15pm - 2:40pm	Frickert, A	26D-2421

■ **HIST 16 — The Wild West - A History, 1800-1890** 3.0 Units
 Degree Applicable, CSU, UC

(May be taken for option of Letter grade or Pass/NoPass)

Prerequisite: Eligibility for ENGL 68

History of the 19th Century Trans-Mississippi West.

43457	MW	11:30am - 12:55pm	Hoffman, H	26A-1821
-------	----	-------------------	------------	----------

■ **HIST 19 — History of Mexico** 3.0 Units
 Degree Applicable, CSU, UC

Prerequisite: Eligibility for ENGL 68

Cultural and social history of the Mexican people from pre-Columbian civilization to modern Mexico.

43458	TTh	11:30am - 12:55pm	Tellez, A	26A-1831
-------	-----	-------------------	-----------	----------

■ **HIST 31 — History of the African American** 3.0 Units
 Degree Applicable, CSU, UC

Prerequisite: Eligibility for ENGL 68

History and culture of African Americans from Reconstruction period to the present.

43459	MW	1:15pm - 2:40pm	Browne, E	18D-1101
43460	TTh	1:15pm - 2:40pm	Browne, E	18D-1101
43461	TTh	3:00pm - 4:25pm	Browne, E	18D-1101

■ **HIST 35 — History of Africa** 3.0 Units
 Degree Applicable, CSU, UC

Prerequisite: Eligibility for ENGL 68

History of Africa from prehistoric times to the present with a focus on cultural, social, political, and economic changes.

43462	TTh	11:30am - 12:55pm	Grimstad, A	18D-1101
-------	-----	-------------------	-------------	----------

■ **HIST 36 — Women in American History** **3.0 Units**
Degree Applicable, CSU, UC

Prerequisite: Eligibility for English 1A

Women's experience within the context of major themes of United States history from Colonial times to the present.

43463	MW	11:30am - 12:55pm	Earhart, K	26D-G431
43468	TTh	11:30am - 12:55pm	Kremer, A	40-133
43467	MW	1:15pm - 2:40pm	Earhart, K	26D-G431
43464	TTh	1:15pm - 2:40pm	Kremer, A	40-133
43466	T	7:00pm - 10:10pm	Lamphier, P	26D-2421

NOTE: No cost digital textbooks or textual materials used.

43478 arrange 3.4 hours Cannon, K ONLINE
NOTE: CRN 43478 is a Distance Learning Online Class.

How to Begin Course: Log into Canvas through <http://myportal.mtsac.edu> and click on CRN for your DL course. **NOTE:** Some courses may not be activated until the start of the term. If you cannot locate your DL course in Canvas when the term starts, contact the professor. **On the first day of classes, log into your DL course to show your "attendance" because not doing so could result in your being dropped from the class for non-attendance.**

Professor contact info: Email Professor Cannon at either: KCannon@mtsac.edu, through Student Detail Schedule or Canvas at MyMTSAC Portal.

Students must use their Mt. SAC e-mail account and be aware of course commitment and student expectations described at <http://www.mtsac.edu/instruction/learning/distlearn/>

To prepare for a successful online learning experience, see helpful short videos at <http://www.mtsac.edu/distancelearning/quiz/>

44318 arrange 3.4 hours Haines, A ONLINE
NOTE: CRN 44318 is a Distance Learning Online Class. No cost digital textbooks or textual materials used.

How to Begin Course: Log into Canvas through <http://myportal.mtsac.edu> and click on CRN for your DL course. **NOTE:** Some courses may not be activated until the start of the term. If you cannot locate your DL course in Canvas when the term starts, contact the professor. **On the first day of classes, log into your DL course to show your "attendance" because not doing so could result in your being dropped from the class for non-attendance.**

Professor contact info: Email Professor Haines at either: AHaines@mtsac.edu, through Student Detail Schedule or Canvas at MyMtSAC Portal.

Students must use their Mt. SAC e-mail account and be aware of course commitment and student expectations described at <http://www.mtsac.edu/instruction/learning/distlearn/>

To prepare for a successful online learning experience, see helpful short videos at <http://www.mtsac.edu/distancelearning/quiz/>

44319 arrange 3.4 hours Haines, A ONLINE
NOTE: CRN 44319 is a Distance Learning Online Class. No cost digital textbooks or textual materials used.

How to Begin Course: Log into Canvas through <http://myportal.mtsac.edu> and click on CRN for your DL course. **NOTE:** Some courses may not be activated until the start of the term. If you cannot locate your DL course in Canvas when the term starts, contact the professor. **On the first day of classes, log into your DL course to show your "attendance" because not doing so could result in your being dropped from the class for non-attendance.**

Professor contact info: Email Professor Haines at either: AHaines@mtsac.edu, through Student Detail Schedule or Canvas at MyMtSAC Portal.

Students must use their Mt. SAC e-mail account and be aware of course commitment and student expectations described at <http://www.mtsac.edu/instruction/learning/distlearn/>

To prepare for a successful online learning experience, see helpful short videos at <http://www.mtsac.edu/distancelearning/quiz/>

■ **HIST 39 — California History** **3.0 Units**
Degree Applicable, CSU, UC

Prerequisite: Eligibility for ENGL 68

The social, economic, and political development of California and the Pacific Coast from the earliest times to the present.

43469	MW	8:00am - 9:25am	Hoffman, H	26A-1821
43470	MW	9:45am - 11:10am	Hoffman, H	26A-1821

■ **HIST 40 — History of the Mexican American** **3.0 Units**
Degree Applicable, CSU, UC

Prerequisite: Eligibility for ENGL 68

U.S. History with a special emphasis on the role of Mexican Americans in the development of the nation.

43471	MW	8:30am - 9:55am	Chavez, R	21C-1
43472	TTh	9:45am - 11:10am	Tellez, A	26A-1831
43473	T	1:15pm - 4:25pm	Tellez, A	26A-1831
43474	Th	1:15pm - 4:25pm	Tellez, A	26A-1831
43475	W	6:30pm - 9:40pm	Menzing, T	26D-2421

■ **HIST 44 — History of Native Americans** **3.0 Units**
Degree Applicable, CSU, UC

Prerequisite: Eligibility for ENGL 68

History of the U.S. from Colonial times to the present with special emphasis on the role of Native Americans.

43476	TTh	10:15am - 11:40am	Chavez, R	26A-1811
-------	-----	-------------------	-----------	----------

HISTOTECHNOLOGY

■ **HT 12 — Beginning Histotechniques** **5.0 Units**
Degree Applicable

Prerequisite: HT 1 and HT 2

Advisory: MICR 22

Theory and practice of histotechnology. Fixation, processing, embedding, microtomy and hematoxylin-eosin (HandE) stain.

41761	TTh	9:45am - 11:10am	Mac Donald, J	60-2512
	and TTh	11:30am - 2:40pm	Mac Donald, J	60-2512

■ **HT 16 — Histochemistry and Immunohistochemistry** **4.0 Units**
Degree Applicable

Prerequisite: HT 12 and HT 10

Practical applications of enzyme and immunological reactions as they relate to tissue staining. Field trip required.

41762	MW	9:45am - 11:10am	Mac Donald, J	60-2512
	and W	11:30am - 2:40pm	Mac Donald, J	60-2512

■ **HT 17 — Work Experience in Histotechnology** **1.0 Unit**
Degree Applicable

(May be taken for Pass/No Pass Only)

Prerequisite: HT 12 and compliance with Work Experience regulations as designated in the College Catalog

On-the-job experience in histotechnology at an approved work site.

Placement by Program Director.

41763	arrange	4.7 hours	Mac Donald, J	60-2411
-------	---------	-----------	---------------	---------

■ **HT 17 — Work Experience in Histotechnology** **2.0 Units**
Degree Applicable

(May be taken for Pass/No Pass Only)

Prerequisite: HT 12 and compliance with Work Experience regulations as designated in the College Catalog

On-the-job experience in histotechnology at an approved work site.

Placement by Program Director.

41764	arrange	9.4 hours	Mac Donald, J	60-2411
-------	---------	-----------	---------------	---------

HONORS PROGRAM

The following classes are open to students in the Mt. SAC Honors Program only. Information on eligibility, admissions and benefits can be found at <http://honors.mtsac.edu>. The basic admission requirements for the Honors Program are:

For all first-time college students:

1. Eligibility for English 1A
2. 3.2 cumulative GPA (unweighted)

For students who have already completed college courses:

1. Eligibility for English 1A
2. 3.2 transferable GPA
3. Completion of 9 transferable units

To apply, go to <http://honors.mtsac.edu> and complete the downloadable application and submit with the required documents. For more information, contact the Honors Program at (909)274-4665, honors@mtsac.edu, or visit us in Building 26A, Room 1680.

Honors Courses Available

■ ANTH 1H — Biological Anthropology - Honors	3.0 Units
41680 TTh 8:00am - 9:25am Borella, F	61-2312
■ AHIS 3H — History of Women and Gender in Art - Honors	3.0 Units
44096 TTh 9:45am - 11:10am Caldwell, E	26D-2220
■ ASTR 5H — Introduction to Astronomy - Honors	3.0 Units
41987 F 9:00am - 12:10pm Christopher, M	11-2119
■ BUSC 1BH — Principles of Economics - Microeconomics - Honors	3.0 Units
44348 TTh 9:45am - 11:10am Villaseñor, S	78-3180
■ CHEM 50H — General Chemistry I - Honors	5.0 Units
44160 TTh 8:00am - 11:10am Roueintan, M	60-3620
and TTh 11:30am - 12:55pm Roueintan, M	7-2102
41862 MW 9:45am - 11:10am Chen, J	7-2102
and MW 11:30am - 2:40pm Chen, J	60-3620
■ CHEM 51H — General Chemistry II - Honors	5.0 Units
43480 TTh 8:00am - 9:25am Di Mauro, E	7-1201
and F 8:00am - 2:35pm Di Mauro, E	60-3628
■ CHLD 10H — Child Growth and Lifespan Development - Honors	3.0 Units
40991 T 3:00pm - 6:10pm Hughey, D	73-1820
■ ENGL 1AH — Freshman Composition - Honors	4.0 Units
42671 TTh 7:30am - 9:35am Cannon, H	26D-3491
42893 TTh 4:30pm - 6:35pm Ceniceroy, J	26A-2841
■ ENGL 1CH — Critical Thinking and Writing - Honors	4.0 Units
42690 MW 7:30am - 9:35am Cannon, H	26D-3491
NOTE: CRN 42690 above is linked to MUS 13H (CRN 43815) and is designated for students in the Honors Fast Track Program. Please call the Honors Program at (909)274-4665 for further information.	
42815 MW 9:45am - 11:50am Cannon, H	26D-3491
42866 TTh 6:45pm - 8:50pm Brantingham, J	26D-3411
■ GEOL 8H — Earth Science - Honors	3.0 Units
43383 MW 8:00am - 9:25am Mrofska, D	60-1515
■ HIST 4H — World History: Early Modern to the Present - Honors	3.0 Units
43438 MW 11:30am - 12:55pm Grimstad, A	18D-1101
■ HIST 8H — History of the United States from 1865 - Honors	3.0 Units
43454 TTh 1:15pm - 2:40pm Cannon, K	26D-G431
■ MATH 110H — Elementary Statistics - Honors	3.0 Units
42127 F 8:30am - 11:40am Guth, S	61-2306

■ MUS 13H — Introduction to Music Appreciation - Honors	3.0 Units
43815 MW 9:45am - 11:10am Kuo, T	1B/C-1
NOTE: CRN 43815 above is linked to ENGL 1CH (CRN 42690) and is designated for students in the Honors Fast Track Program. Please call the Honors Program at (909)274-4665 for further information.	
43821 MW 1:15pm - 2:40pm Kuo, T	1B/C-1
NOTE: CRN 43821: No-cost digital textbooks or textual materials used	

■ PHIL 3H — Introduction to Logic - Honors	3.0 Units
44150 MW 9:45am - 11:10am Mc Gruder, C	26D-2240

■ PHIL 15H — Major World Religions - Honors	3.0 Units
44185 TTh 11:30am - 12:55pm Diem, A	26D-2431
NOTE: No cost digital textbooks or textual materials used.	

■ POLI 1H — Introduction to American Government and Politics - Honors	3.0 Units
42378 TTh 9:45am - 11:10am Rivera, K	26D-G290
NOTE: No cost digital textbooks or textual materials used.	

■ PSYC 1AH — Introduction to Psychology - Honors	3.0 Units
42513 TTh 9:45am - 11:10am Louie, C	26A-2831

■ SOC 1H — Sociology - Honors	3.0 Units
42589 MW 11:30am - 12:55pm Rillorta, L	26D-2230

■ SOC 20H — Sociology of Ethnic Relations - Honors	3.0 Units
43023 MW 9:45am - 11:10am Rillorta, L	26D-2230

■ SPCH 1AH — Public Speaking - Honors	4.0 Units
42373 MW 12:00pm - 2:05pm Klawitter, K	26D-G481

HOSPITALITY AND RESTAURANT MANAGEMENT

■ HRM 51 — Introduction to Hospitality	3.0 Units
	Degree Applicable, CSU

Prerequisite: Eligibility for ENGL 68

Hospitality industry segments and types of operations with an emphasis on career opportunities.

41194 M 6:30pm - 9:40pm STAFF	78-1100
NOTE: CRN 41194 field trip required.	

41026 arrange 3.4 hours STAFF	ONLINE
-------------------------------	--------

NOTE: CRN 41026 is a Distance Learning Online Class.

Other Course Requirements: Field trip required.

How to Begin Course: Log into Canvas through the eLearning Tools tab in the Mt. SAC portal at my.mtsac.edu. Then click on the Canvas link and then click on CRN for your DL course. **NOTE:** Some courses may not be activated until the start of the term. If you cannot locate your DL course in Canvas when the term starts, contact the professor.

Professor contact info: Email Professor STAFF at either: STAFF@mtsac.edu, through Student Detail Schedule or Canvas at MyMtSAC Portal.

Students must use their Mt. SAC e-mail account and be aware of course commitment and student expectations described at <http://www.mtsac.edu/instruction/learning/distlearn/>

44156 arrange 6.8 hours Doonan, S	ONLINE
8 Weeks, Week beginning 02/26/2018 ending 04/22/2018	

NOTE: CRN 44156 is a Distance Learning Online Class. Field trip required.

How to Begin Course: Log into Canvas through the eLearning Tools tab in the Mt. SAC portal at my.mtsac.edu. Then click on the Canvas link and then click on CRN for your DL course. **NOTE:** Some courses may not be activated until the start of the term. If you cannot locate your DL course in Canvas when the term starts, contact the professor.

Professor contact info: Email Professor Doonan at either: SDoonan@mtsac.edu, through Student Detail Schedule or Canvas at MyMtSAC Portal.

Students must use their Mt. SAC e-mail account and be aware of course commitment and student expectations described at <http://www.mtsac.edu/instruction/learning/distlearn/>

MT. SAN ANTONIO COLLEGE HONORS PROGRAM APPLICATION

PLEASE FILL IN THE INFORMATION BELOW.

FIRST NAME	MIDDLE NAME	LAST NAME
MT. SAC STUDENT IDENTIFICATION NUMBER		PHONE NUMBER
MT. SAC E-MAIL ADDRESS (@student.mtsac.edu)		ADDITIONAL E-MAIL ADDRESS
ADDRESS		
CITY	STATE	ZIP CODE

ATTACH DOCUMENTS SHOWING THAT YOU HAVE MET THE FOLLOWING REQUIREMENTS (INCOMPLETE APPLICATIONS WILL NOT BE PROCESSED):

- A)** For students entering the program directly from high school and first-time college:
- ENGLISH IA ELIGIBILITY
 - 3.2 CUMULATIVE GPA (DOCUMENTED ON HIGH SCHOOL TRANSCRIPT),
 - TEACHER RECOMMENDATION
 - SHORT ESSAY (CONTACT HONORS@MTSAC.EDU FOR ESSAY QUESTIONS)
 - AP/IB SCORES IF APPLICABLE
- B)** For students who have already enrolled in college courses:
- UNOFFICIAL TRANSCRIPT THAT SHOWS:
 - ENGLISH IA ELIGIBILITY
 - 3.2 CUMULATIVE GPA WITH AT LEAST 9 TRANSFERABLE UNITS.
NOTE: IF YOU ARE ENROLLED IN CLASSES WHOSE OFFICIAL GRADES ARE NOT AVAILABLE, SUBMIT A WORK IN PROGRESS FORM.
 - AP/IB SCORES IF APPLICABLE
 - SHORT ESSAY (CONTACT HONORS@MTSAC.EDU FOR ESSAY QUESTIONS)
 - LETTER OF RECOMMENDATION*
*LETTER OF RECOMMENDATION WAIVED IF MT.SAC TRANSFER LEVEL GPA IS OVER 3.5

MEMBERSHIP IN THE HONORS PROGRAM IS A PRIVILEGE. HONORS STUDENTS ARE EXPECTED TO:

- ATTEND HONORS ORIENTATION
- CHECK MT. SAC EMAIL ACCOUNT EACH WEEK
- READ THE HONORS STUDENT HANDBOOK
- NOTIFY THE PROGRAM OF CHANGES IN CONTACT INFORMATION
- MEET WITH THE EDUCATIONAL ADVISOR OR COUNSELOR TO PLAN COURSEWORK
- MAINTAIN A CUMULATIVE GPA OF AT LEAST 3.2 (COMPLETION OF HONORS REQUIRES A 3.2)
- TREAT HONORS PROGRAM STAFF AND STUDENTS WITH RESPECT
- TREAT THE HONORS CENTER WITH RESPECT (CLEAN UP AFTER YOURSELF, NO COMPUTER GAMES, NO DOWNLOADING, NO DISRUPTIVE BEHAVIOR, ETC.)

I AGREE TO FOLLOW THE GUIDELINES ABOVE.

APPLICANT'S SIGNATURE	DATE
-----------------------	------

**SUBMIT YOUR APPLICATION AND SUPPORTING DOCUMENTS TO:
MT. SAN ANTONIO COLLEGE HONORS PROGRAM
1100 N. GRAND AVE. BUILDING 26A, ROOM 1680
WALNUT, CA 91789
TEL: (909) 274-4665
EMAIL: HONORS@MTSAC.EDU — WEBSITE: HTTP://HONORS.MTSAC.EDU**

LAST _____ FIRST _____

OFFICE USE ONLY
APPROVED / DENIED SIGNATURE _____ DATE _____
LETTER _____ ENGL IA _____
COMMENTS:

■ **HRM 52 — Food Safety and Sanitation** **1.5 Units**
Degree Applicable, CSU

Prerequisite: Eligibility for ENGL 68

Principles of safety and sanitation in the food service industry.

41027 M 8:00am - 11:10am Chavez, S 78-1100
8 Weeks, Week beginning 02/26/2018 ending 04/22/2018

NOTE: CRN 41027- This course requires the passing of the Food Manager Exam to receive credit. Exam date: Monday, April 16 from 8:00-11:00am in 78-2140.

41255 arrange 3.4 hours STAFF ONLINE
8 Weeks, Week beginning 04/23/2018 ending 06/17/2018

NOTE: CRN 41255 is a Distance Learning Online Class.

NOTE: This course requires the passing of the Food Manager Exam to receive credit. Exam date: Monday, 06/11 from 8:00 am -11:00 am in 17-13.

How to Begin Course: Log into Canvas through the eLearning Tools tab in the Mt. SAC portal at my.mtsac.edu. Then click on the Canvas link and then click on CRN for your DL course. **NOTE:** Some courses may not be activated until the start of the term. If you cannot locate your DL course in Canvas when the term starts, contact the professor.

Professor contact info: Email Professor STAFF at either: STAFF@mtsac.edu, through Student Detail Schedule or Canvas at MyMtSAC Portal.

Students must use their Mt. SAC e-mail account and be aware of course commitment and student expectations described at <http://www.mtsac.edu/instruction/learning/distlearn/>

41256 arrange 3.4 hours Doonan, S ONLINE
8 Weeks, Week beginning 04/23/2018 ending 06/17/2018

NOTE: CRN 41256 is restricted to students who have applied and been accepted into the Culinary Arts Cohort.

Effective Mon., 2/5 @ 12:30 PM, this section will be OPENED TO ALL students.

CRN 41256 is a Distance Learning Online Class.

NOTE: This course requires the passing of the Food Manager Exam to receive credit. Exam date: Monday, 06/11 from Time 8:00 -11:00am in 17-13.

How to Begin Course: Log into Canvas through the eLearning Tools tab in the Mt. SAC portal at my.mtsac.edu. Then click on the Canvas link and then click on CRN for your DL course. **NOTE:** Some courses may not be activated until the start of the term. If you cannot locate your DL course in Canvas when the term starts, contact the professor.

Professor contact info: Email Professor STAFF at either: STAFF@mtsac.edu, through Student Detail Schedule or Canvas at MyMtSAC Portal.

Students must use their Mt. SAC e-mail account and be aware of course commitment and student expectations described at <http://www.mtsac.edu/instruction/learning/distlearn/>

■ **HRM 53 — Dining Room Service Management** **3.0 Units**
Degree Applicable, CSU

Skills and knowledge needed for all aspects of dining room service management. Field trip required.

41230 M 3:00pm - 6:10pm STAFF 78-1190

■ **HRM 54 — Basic Cooking Techniques** **3.0 Units**
Degree Applicable, CSU

Prerequisite: HRM 52

Professional cooking techniques for commercial operations. Uniform, knife set, ServSafe Manager Certification required.

41231 TTh 7:30am - 9:35am Doonan, S 78-1190
and TTh 9:45am - 12:55pm Doonan, S 78-1190
8 Weeks, Week beginning 02/26/2018 ending 04/22/2018

NOTE: CRN 41231 Students must carry a valid Food Handler Card or Food Manager Card before registering for the class and present their card on the first day of class. Students without a Food Handler Card may be dropped from class.

41232 TTh 7:30am - 9:35am Doonan, S 78-1190
and TTh 9:45am - 12:55pm Doonan, S 78-1190
8 Weeks, Week beginning 02/26/2018 ending 04/22/2018

NOTE: CRN 41232 is restricted to students who have applied and been accepted into the Culinary Arts Cohort.

Effective Mon., 2/5 @ 12:30 PM, this section will be OPENED TO ALL students.

NOTE: Students must carry a valid Food Handler Card or Food Manager Card before registering for the class and present their card on the first day of class. Students without a Food Handler Card may be dropped from class.

■ **HRM 57 — Hospitality Cost Control** **3.0 Units**
Degree Applicable, CSU

Corequisite: HRM 51 (May have been taken previously)

Analyzing and managing: food, beverage, labor, and other costs within a hospitality operation.

41028 W 8:00am - 11:10am Chavez, S 78-1100

■ **HRM 61 — Menu Planning** **3.0 Units**
Degree Applicable, CSU

Advisory: HRM 51

Menu development, design, and analysis. Includes demographics, costing, pricing, and a practical concept-to-creation project.

41029 M 8:00am - 11:10am Hanna, R 78-1190

■ **HRM 64 — Hospitality Financial Accounting** **3.0 Units**
Degree Applicable, CSU

Prerequisite: BUSA 11 or Eligibility for MATH 50

Financial accounting specific to hospitality businesses. Emphasis on: bookkeeping, financial statements development and analysis.

41030 TTh 1:15pm - 2:40pm Chavez, S 78-1100

■ **HRM 66 — Hospitality Law** **3.0 Units**
Degree Applicable, CSU

Advisory: HRM 51

Business law topics as they relate to the hospitality industry. Field trip required.

41031 MW 11:30am - 12:55pm Chavez, S 78-1100

■ HRM 81 — Garde Manger **3.0 Units**
Degree Applicable

Preparation and presentation of: sauces, soups, salads, sandwiches, appetizers, hors d'oeuvres, and buffets.

41234	TTh	1:15pm - 3:20pm	Shum, M	78-1190
and	TTh	3:30pm - 6:40pm	Shum, M	78-1190

8 Weeks, Week beginning 02/26/2018 ending 04/22/2018

NOTE: CRN 43955 Students must carry a valid Food Handler Card or Food Manager Card before registering for the class and present their card on the first day of class. Students without a Food Handler Card may be dropped from class.

41235	TTh	1:15pm - 3:20pm	Shum, M	78-1190
and	TTh	3:30pm - 6:40pm	Shum, M	78-1190

8 Weeks, Week beginning 02/26/2018 ending 04/22/2018

NOTE: CRN 41235 is restricted to students who have applied and been accepted into the Culinary Arts Cohort.

Effective Mon., 2/5 @ 12:30 PM, this section will be OPENED TO ALL students.

NOTE: Students must carry a valid Food Handler Card or Food Manager Card before registering for the class and present their card on the first day of class. Students without a Food Handler Card may be dropped from class.

■ HRM 82 — Baking and Pastry **3.0 Units**
Degree Applicable

Preparation of baked goods and pastries.

41236	TTh	1:15pm - 3:20pm	Shum, M	78-1190
and	TTh	3:30pm - 6:40pm	Shum, M	78-1190

8 Weeks, Week beginning 04/23/2018 ending 06/17/2018

NOTE: CRN 41236 Students must carry a valid Food Handler Card or Food Manager Card before registering for the class and present their card on the first day of class. Students without a Food Handler Card may be dropped from class.

41237	TTh	1:15pm - 3:20pm	Shum, M	78-1190
and	TTh	3:30pm - 6:40pm	Shum, M	78-1190

8 Weeks, Week beginning 04/23/2018 ending 06/17/2018

NOTE: CRN 41237 is restricted to students who have applied and been accepted into the Culinary Arts Cohort.

Effective Mon., 2/5 @ 12:30 PM, this section will be OPENED TO ALL students.

NOTE: Students must carry a valid Food Handler Card or Food Manager Card before registering for the class and present their card on the first day of class. Students without a Food Handler Card may be dropped from class.

■ HRM 83 — International Cuisines **3.0 Units**
Degree Applicable

Preparation of international cuisines from Asia, Europe, the Mediterranean, and Latin America.

41238	TTh	7:30am - 9:35am	Doonan, S	78-1190
and	TTh	9:40am - 12:55pm	Doonan, S	78-1190

8 Weeks, Week beginning 04/23/2018 ending 06/17/2018

NOTE: CRN 41238 Students must carry a valid Food Handler Card or Food Manager Card before registering for the class and present their card on the first day of class. Students without a Food Handler Card may be dropped from class.

41239	TTh	7:30am - 9:35am	Doonan, S	78-1190
and	TTh	9:45am - 12:55pm	Doonan, S	78-1190

8 Weeks, Week beginning 04/23/2018 ending 06/17/2018

NOTE: CRN 41239 is restricted to students who have applied and been accepted into the Culinary Arts Cohort.

Effective Mon., 2/5 @ 12:30 PM, this section will be OPENED TO ALL students.

NOTE: Students must carry a valid Food Handler Card or Food Manager Card before registering for the class and present their card on the first day of class. Students without a Food Handler Card may be dropped from class.

■ HRM 91 — Hospitality Work Experience **1.0 Unit**
Degree Applicable, CSU

(May be taken for Pass/No Pass Only)

Prerequisite: Compliance with Work Experience regulations as designated in the College Catalog

On-the-job experience related to classroom-based learning. 75 paid or 60 non-paid hours required for each unit of credit.

41032	arrange	4.7 hours	Chavez, S	OCAM
-------	---------	-----------	-----------	------

NOTE: CRN 41032 Provides the student with on-the-job experience in an approved work site. A minimum of 75 paid hours or 60 non-paid hours per term is required for each unit of credit. Work experience placement is not guaranteed. Student must contact Career Services Specialist, Dawn Finley at dfinley@mtsac.edu by January 22, 2018

■ HRM 91 — Hospitality Work Experience **4.0 Units**
Degree Applicable, CSU

(May be taken for Pass/No Pass Only)

Prerequisite: Compliance with Work Experience regulations as designated in the College Catalog

On-the-job experience related to classroom-based learning. 75 paid or 60 non-paid hours required for each unit of credit.

41217	arrange	18.75 hours	Chavez, S	OCAM
-------	---------	-------------	-----------	------

NOTE: CRN 41217 Provides the student with on-the-job experience in an approved work site. A minimum of 75 paid hours or 60 non-paid hours per term is required for each unit of credit. Work experience placement is not guaranteed. Student must contact Career Services Specialist, Dawn Finley at dfinley@mtsac.edu by January 22, 2018

HUMANITIES

■ HUMA 1 — The Humanities **3.0 Units**
Degree Applicable, CSU, UC

Prerequisite: Eligibility for ENGL 68

Interdisciplinary study of western society. Off-campus assignments may be required.

44109	MW	11:30am - 12:55pm	Edson, T	26D-2491
44114	TTh	11:30am - 12:55pm	Edson, T	26D-2240
44110	MW	1:15pm - 2:40pm	Edson, T	26D-2220

INDUSTRIAL DESIGN ENGINEERING

■ IDE 150 — Design Foundations **3.0 Units**
Degree Applicable, CSU

Prerequisite: IDE 110 and IDE 120 and IDE 130

Corequisite: IDE 160 and IDE 170

Digital graphic media for industrial design used to convey complex design and manufacturing criteria.

41347	MW	11:30am - 12:20pm	Phamdo, D	28B-305
and	MW	12:30pm - 2:00pm	Phamdo, D	28B-305

■ IDE 160 — Intermediate CAD **3.0 Units**
Degree Applicable, CSU

Prerequisite: IDE 110 and IDE 120 and IDE 130

Corequisite: IDE 150 and IDE 170

Applications, methods, theories, and industrial design processes. Includes sketching and CAD parametric solid modeling.

41348	TTh	11:30am - 12:20pm	James, S	28B-310
and	TTh	12:30pm - 2:00pm	James, S	28B-310

■ IDE 170 — Introduction to Prototyping **3.0 Units**
Degree Applicable, CSU

Prerequisite: IDE 110 and IDE 120 and IDE 130

Corequisite: IDE 150 and IDE 160

Processes and materials employed when creating breadboards, proof of concept models, form studies, prototypes.

41349	TTh	8:00am - 8:50am	Takahashi, S	28A-102K
and	TTh	9:00am - 10:30am	Takahashi, S	28A-102K

■ **IDE 250 — Product Design and Viability** **6.0 Units**
Degree Applicable, CSU

Prerequisite: IDE 210 and IDE 220 and IDE 230

Corequisite: IDE 270

Product life cycle from design to manufacturing and distribution.

Portfolio-based course that includes fabrication of a product.

41493	MW	9:00am - 10:25am	James, S	28A-102K
and	MW	10:35am - 12:00pm	James, S	28A-102K
and	MW	12:30pm - 3:35pm	James, S	28A-102K

■ **IDE 270 — Manufacturing Processes and Materials** **3.0 Units**
Degree Applicable, CSU

Prerequisite: IDE 210 and IDE 220 and IDE 230

Corequisite: IDE 250

Relationships between common manufacturing processes and their impact on the design process.

41494	TTh	11:00am - 2:50pm	Cusolito, A	28B-310
and	T	3:00pm - 3:50pm	Takahashi, S	28B-310

INTERIOR DESIGN

■ **ID 10 — Introduction to Interior Design** **2.0 Units**
Degree Applicable, CSU

Interior design that meet individual, functional and environmental needs. Field trips may be required.

41166	MW	9:45am - 11:50am	Ball, H	77-2070
8 Weeks, Week beginning 02/26/2018 ending 04/22/2018				
41167	T	6:30pm - 8:35pm	Woods, L	13-1230
41168	S	9:00am - 11:05am	Noonan, I	13-1230

■ **ID 10L — Introduction to Interior Design Laboratory** **1.0 Unit**
Degree Applicable, CSU

Corequisite: ID 10 (May have been taken previously)

Application of interior design practice that meet individual, functional and environmental needs. Field trips may be required.

41169	S	11:30am - 2:40pm	Noonan, I	13-1230
-------	---	------------------	-----------	---------

■ **ID 21 — Color and Design Theory II** **3.0 Units**
Degree Applicable, CSU

Advisory: ID 20

Systematic process of designing three-dimensional objects. Field trips may be required.

41057	T	9:00am - 11:05am	Lo, N	13-1230
and	T	11:30am - 2:40pm	Lo, N	13-1230

■ **ID 22 — Design Drawing for Interior Design** **3.0 Units**
Degree Applicable, CSU

Communication elements required to convey design ideas to building trades. Field trips may be required.

41058	Th	9:45am - 11:50am	Tran, N	13-1230
and	Th	12:00pm - 3:10pm	Tran, N	13-1230

■ **ID 25 — Space Planning for Interior Design I** **3.0 Units**
Degree Applicable, CSU

Prerequisite: ID 22 or ID 23 or ARCH 141 or ARCH 11

Federal and state codes and specifications for life-safety requirements. Field trips may be required.

41059	F	9:45am - 11:50am	Tran, N	13-1230
and	F	12:00pm - 3:10pm	Tran, N	13-1230

■ **ID 26 — Space Planning for Interior Design II** **3.0 Units**
Degree Applicable, CSU

Prerequisite: ID 22 or ID 23 or ARCH 141 or ARCH 11

Advisory: ID 25

Space planning with an emphasis on programming, furniture standards and codes. Field trips may be required.

41060	W	9:45am - 11:50am	Tran, N	13-1230
and	W	12:00pm - 3:10pm	Tran, N	13-1230

Design Your World



Industrial Design Engineering

Learn Product Design, CAD, Engineering and Fabrication using 3D Printers, Laser Cutters and Machines.

Manufacturing Technology

Learn CAD/ Solidworks and AutoCAD MasterCAM, CNC Programming, Machining.

For information and a shop tour, call
909.274.5214

■ **ID 29 — Interior Design Studio I** **3.0 Units**
Degree Applicable, CSU

Prerequisite: ID 26

Advisory: ID 12, ID 21, ID 27

Analysis and application of design concepts to interior environments in a studio environment. Field trips may be required.

44218	M	9:45am - 11:50am	Tran, N	13-1230
and	M	12:00pm - 3:10pm	Tran, N	13-1230

■ **ID 31 — Building Systems for Interior Design** **3.0 Units**
Degree Applicable, CSU

Prerequisite: ID 22 or ID 23 or ARCH 141 or ARCH 11

Residential and commercial construction systems and materials. Field trips may be required.

41192	W	3:15pm - 5:20pm	Gidcumb, G	13-1230
and	W	5:30pm - 8:40pm	Gidcumb, G	13-1230

■ **ID 34 — Computer Aided Drawing for Interior Design II** **3.0 Units**
Degree Applicable, CSU

Advisory: ID 22 or ARCH 141 or ARCH 11

Three-dimensional computer modeling, rendering, lighting and fly-throughs as used in interior design. Field trips may be required.

41063	Th	3:15pm - 5:20pm	Mansouri, B	13-1230
and	Th	5:30pm - 8:40pm	Mansouri, B	13-1230

■ **ID 37 — Business Practices for Interior Design** **3.0 Units**
Degree Applicable

Principles and procedures for interior design professionals to start a business. Field trips may be required.

44219	T	3:00pm - 6:10pm	Lo, N	13-1230
-------	---	-----------------	-------	---------

Start Here.

Go Anywhere.

Interior Design



mtsac.edu



Receive A Certificate In Just One Semester



■ ID 38 — Internship in Interior Design

2.0 Units
Degree Applicable

(May be taken for Pass/No Pass Only)

Prerequisite: Compliance with Work Experience/Internship regulations as designated in the College Catalog

Designed to provide the student with actual on-the-job experience in the interior design profession.

41061 arrange 9.4 hours Tran, N OCAM

NOTE: CRN 41061 Provides the student with on-the-job experience in an approved work site. A minimum of 75 paid hours or 60 non-paid hours per term is required for each unit of credit. Work experience placement is not guaranteed. Student must contact Career Services Specialist, Dawn Finley at dfinley@mtsac.edu by January 22, 2018

■ ID 39 — Interior Design Studio II

3.0 Units
Degree Applicable, CSU

Prerequisite: ID 26

Advisory: ID 29

Analysis and application of design concepts to interior environments.

Field trips may be required.

41207 M 9:45am - 11:50am Tran, N 13-1230
and M 12:00pm - 3:10pm Tran, N 13-1230

■ ID 40 — Kitchen and Bath Studio I

3.0 Units
Degree Applicable

Prerequisite: ID 22 or ARCH 11 or ARCH 141

Advisory: ID 32 and ID 31 and ID 25

Kitchen and bath design with an emphasis on NKBA's Planning Guidelines. Field trips may be required.

44220 M 3:15pm - 5:20pm STAFF 13-1230
and M 5:30pm - 8:40pm STAFF 13-1230

■ ID 41 — Kitchen and Bath Studio II

3.0 Units
Degree Applicable

Prerequisite: ID 40

Advisory: ID 32

Kitchen and bath design that focuses on universal design, design concepts, and historical design. Field trips may be required.

44221 M 3:15pm - 5:20pm STAFF 13-1230
and M 5:30pm - 8:40pm STAFF 13-1230

■ ID 48 — Internship in Kitchen and Bath

3.0 Units
Degree Applicable

(May be taken for Pass/No Pass Only)

Prerequisite: Compliance with Work Experience/Internship regulations as designated in the College Catalog

Corequisite: ID 40 (May have been taken previously)

Job experience in the interior design profession at NKBA member work site. 75 paid or 60 non-paid clock hours required.

41062 arrange 14.1 hours Tran, N OCAM

NOTE: CRN 41062 Provides the student with on-the-job experience in an approved work site. A minimum of 75 paid hours or 60 non-paid hours per term is required for each unit of credit. Work experience placement is not guaranteed. Student must contact Career Services Specialist, Dawn Finley at dfinley@mtsac.edu by January 22, 2018

ITALIAN

■ ITAL 1 — Elementary Italian

4.0 Units
Degree Applicable, CSU, UC

Intended for students without previous exposure to Italian.

42939 TTh 7:30am - 9:35am Spanu, L 26B-3551
42941 MW 9:45am - 11:50am Petry, P 18-13
42940 MW 12:00pm - 2:05pm Ott, S 26B-3551
42942 TTh 12:00pm - 2:05pm Santostefano, M 26B-3551
44092 MW 2:15pm - 4:20pm Pettinger, N 26B-3551
42943 TTh 2:15pm - 4:20pm Santostefano, M 26B-3551

■ ITAL 2 — Continuing Elementary Italian

4.0 Units
Degree Applicable, CSU, UC

Prerequisite: ITAL 1

Further development of conversational, reading and writing skills in Italian.

42945 MW 12:00pm - 2:05pm Petry, P 18-13

■ ITAL 3 — Intermediate Italian

4.0 Units
Degree Applicable, CSU, UC

(May be taken for option of Letter grade or Pass/NoPass)

Prerequisite: ITAL 2

Development of intermediate Italian language skills and their use as tools in exploring Italian civilization.

44097 MW 9:45am - 11:50am Ott, S 26B-3551

■ ITAL 4 — Continuing Intermediate Italian 4.0 Units

Degree Applicable, CSU, UC

(May be taken for option of Letter grade or Pass/NoPass)

Prerequisite: ITAL 3

Further development of intermediate skills in Italian.

44113 TTh 9:45am - 11:50am Spanu, L 26B-3551

■ ITAL 60 — Italian Culture Through Cinema 3.0 Units

Degree Applicable, CSU, UC

(May be taken for option of Letter grade or Pass/NoPass)

Italian culture presented through subtitled movies. Lectures and discussions in English.

44116 F 8:30am - 11:40am Pezzer, V 26D-2491

42947 W 6:30pm - 9:40pm Pezzer, V 26D-2491

JAPANESE

■ JAPN 1 — Elementary Japanese 4.0 Units

Degree Applicable, CSU, UC

Elementary course for students without prior exposure to Japanese including an introduction to Japanese culture.

42948 MW 7:30am - 9:35am Appel, K 40-131

42949 TTh 7:30am - 9:35am Luther, M 18-13

42954 F 9:00am - 1:10pm Okubo, E 26B-3555

44119 MW 9:45am - 11:50am Appel, K 40-131

42953 TTh 9:45am - 11:50am Johnston, S 18-5

42951 MW 12:00pm - 2:05pm Saito, S 211-1

42959 MW 12:00pm - 2:05pm Parks, Y 40-133

44312 TTh 12:00pm - 2:05pm Brown, Y 18-11

42950 MW 2:15pm - 4:20pm Fukushima, N 26B-3565

42955 MW 2:15pm - 4:20pm Sawada, M 26B-3555

42956 TTh 2:15pm - 4:20pm Brown, Y 18-11

42957 MW 4:30pm - 6:35pm Fukushima, N 26B-3565

42958 TTh 4:30pm - 6:35pm Tauchi, S 26B-3555

42960 TTh 6:45pm - 8:50pm STAFF 26B-3555

■ JAPN 2 — Continuing Elementary Japanese 4.0 Units

Degree Applicable, CSU, UC

Prerequisite: JAPN 1

Further development of elementary skills in Japanese.

42964 MW 9:45am - 11:50am Tsurumi, K 26B-3555

44120 TTh 12:00pm - 2:05pm Tsurumi, K 26B-3555

42962 MW 2:15pm - 4:20pm Saito, S 211-1

42963 TTh 2:15pm - 4:20pm Tauchi, S 26B-3555

■ JAPN 3 — Intermediate Japanese 4.0 Units

Degree Applicable, CSU, UC

Prerequisite: JAPN 2

Continued development of writing ability emphasizing development of thought through Kanji, Hiragana and Katakana.

42965 TTh 9:45am - 11:50am Tsurumi, K 26B-3555

42966 MW 12:00pm - 2:05pm Tsurumi, K 26B-3555

■ JAPN 4 — Continuing Intermediate Japanese 4.0 Units

Degree Applicable, CSU, UC

Prerequisite: JAPN 3

Continuing intermediate study and review of grammar, vocabulary, culture, and literature.

42967 MW 2:15pm - 4:20pm Parks, Y 40-133

■ JAPN 5 — Advanced Japanese 4.0 Units

Degree Applicable, CSU, UC

Prerequisite: JAPN 4 or equivalent

Japanese communication skills with emphasis on conversational skills for daily and social settings in Japanese culture.

44257 TTh 9:45am - 11:50am Luther, M 18-13

JOURNALISM

■ JOUR 100 — Introduction to Mass Media 3.0 Units

(C-ID JOUR 100) Degree Applicable, CSU, UC

Prerequisite: ENGL 1A

Mass media and interrelationships with society, including history, structure, law, ethics, and trends.

42768 MW 11:30am - 12:55pm DePaola, G 26D-G471

42769 TTh 11:30am - 12:55pm DePaola, G 26D-G471

42804 T 1:15pm - 2:40pm DePaola, G 26D-G471

and arrange 1.7 hours DePaola, G ONLINE

NOTE: CRN 42804 is a Hybrid Class taught partially online with Scheduled Meetings on Campus.

How to Begin Course: Log into Canvas through <http://myportal.mtsac.edu> and click on CRN for your DL course. **NOTE:** Some courses may not be activated until the start of the term. If you cannot locate your DL course in Canvas when the term starts, contact the professor. **On the first day of classes, log into your DL course to show your "attendance" because not doing so could result in your being dropped from the class for non-attendance.**

Professor contact info: Email Professor DePaola at either: GDePaola@mtsac.edu, through Student Detail Schedule or Canvas at MyMt-SAC Portal.

Students must use their Mt. SAC e-mail account and be aware of course commitment and student expectations described at <http://www.mtsac.edu/instruction/learning/distlearn/>

To prepare for a successful online learning experience, see helpful short videos at <http://www.mtsac.edu/distancelearning/quiz/>

■ JOUR 101 — Beginning Newswriting 3.0 Units

(C-ID JOUR 110) Degree Applicable, CSU, UC

(May be taken for option of Letter grade or Pass/NoPass)

Prerequisite: Eligibility for ENGL 1A

Gathering, organizing and writing news in journalistic style across multiple platforms.

42770 TTh 8:00am - 9:25am Albertson, T 26D-3220

■ JOUR 102 — Intermediate Newswriting 3.0 Units

(C-ID JOUR 210) Degree Applicable, CSU, UC

(May be taken for option of Letter grade or Pass/NoPass)

Prerequisite: JOUR 101

Newsgathering, organizing and writing news and features in journalistic style across multiple platforms.

42771 TTh 9:45am - 11:10am Albertson, T 26D-3220

■ JOUR 105 — Editor Training 1.0 Unit

Degree Applicable

(May be taken for option of Letter grade or Pass/NoPass)

Advisory: JOUR 101

Leadership skills for editors or managers using the student media as a practical laboratory.

43061 W 11:30am - 2:40pm STAFF 26D-3220

NOTE: No cost digital textbooks or textual materials used.
■ JOUR 114 — Student News Media Staff 3.0 Units

(C-ID JOUR 130) Degree Applicable, CSU

(May be taken for option of Letter grade or Pass/NoPass)

Practical experience in a newsroom lab setting writing and producing the college student news publications.

42772 T 11:30am - 12:35pm Albertson, T 26D-3220

and T 12:45pm - 2:50pm Albertson, T 26D-3220

and arrange 4.25 hours Albertson, T 26D-3220

NOTE: No cost digital textbooks or textual materials used.

■ **JOUR 115 — Student News Media Editing Staff** **3.0 Units**
(C-ID JOUR 131) Degree Applicable, CSU
(May be taken for option of Letter grade or Pass/NoPass)

Prerequisite: JOUR 114

Management and leadership involvement in writing and producing the college student print publications.

42773 Th 11:30am - 12:35pm Albertson, T 26D-3220
and Th 12:45pm - 2:50pm Albertson, T 26D-3220
and arrange 4.25 hours Albertson, T 26D-3220

NOTE: No cost digital textbooks or textual materials used.

■ **JOUR 116 — Multimedia Storytelling** **3.0 Units**
(C-ID JOUR 120) Degree Applicable, CSU

(May be taken for option of Letter grade or Pass/NoPass)

Prerequisite: Eligibility for ENGL 1A

Multimedia storytelling with a journalism emphasis.

43042 W 8:00am - 10:05am Albertson, T 26D-3220
and W 10:15am - 11:20am Albertson, T 26D-3220
and arrange 2.25 hours Albertson, T 26D-3220

NOTE: No cost digital textbooks or textual materials used.

KINESIOLOGY: ADAPTIVE

■ **KINL 2 — Physical Fitness for the Physically Limited** **1.0 Unit**
Degree Applicable, CSU, UC

(May be taken for option of Letter grade or Pass/NoPass)

A modified physical fitness conditioning program incorporating cardiovascular training exercises.

43084 TTh 9:45am - 11:10am Ripley, D 27A-107

NOTE: CRN 43084: This class will include walking. No-cost digital textbooks or textual materials used.

■ **KINL 18 — Weight Training for the Physically Limited** **.5 Unit**
Degree Applicable, CSU, UC

(May be taken for option of Letter grade or Pass/NoPass)

Designed to assist students develop strength, endurance and flexibility through weight training.

43085 TTh 11:30am - 12:35pm Ripley, D 27A-107

NOTE: CRN 43085: No-cost digital textbooks or textual materials used.

KINESIOLOGY: AQUATICS

■ **KINA 8A — Swimming - Beginning** **1.0 Unit**
Degree Applicable, CSU, UC

(May be taken for option of Letter grade or Pass/NoPass)

43086 MW 8:00am - 9:25am Ruh, L POOL

NOTE: CRN 43086: No-cost digital textbooks or textual materials used.

43088 TTh 8:00am - 9:25am Ruh, L POOL

NOTE: CRN 43088: No-cost digital textbooks or textual materials used.

43093 MW 9:45am - 11:10am Lepp, J POOL

NOTE: CRN 43093: No-cost digital textbooks or textual materials used.

43090 TTh 9:45am - 11:10am Ruh, L POOL

NOTE: CRN 43090: No-cost digital textbooks or textual materials used.

■ **KINA 8B — Swimming - Intermediate** **1.0 Unit**
Degree Applicable, CSU, UC

(May be taken for option of Letter grade or Pass/NoPass)

43087 MW 8:00am - 9:25am Ruh, L POOL

NOTE: CRN 43087: No-cost digital textbooks or textual materials used.

43089 TTh 8:00am - 9:25am Ruh, L POOL

NOTE: CRN 43089: No-cost digital textbooks or textual materials used.

43094 MW 9:45am - 11:10am Lepp, J POOL

NOTE: CRN 43094: No-cost digital textbooks or textual materials used.

43091 TTh 9:45am - 11:10am Ruh, L POOL

NOTE: CRN 43091: No-cost digital textbooks or textual materials used.

■ **KINA 14 — Water Polo** **1.0 Unit**
Degree Applicable, CSU, UC

(May be taken for option of Letter grade or Pass/NoPass)

Fundamental water polo skills including conditioning, drills, and game situations.

43092 MW 9:45am - 11:10am Ruh, L POOL

NOTE: CRN 43092: No-cost digital textbooks or textual materials used.

■ **KINA 20 — Aquatic Fitness** **1.0 Unit**
Degree Applicable, CSU, UC

(May be taken for option of Letter grade or Pass/NoPass)

Student must be able to perform front crawl 50 yards.

43095 MW 11:30am - 12:55pm Lepp, J POOL

NOTE: CRN 43095: No-cost digital textbooks or textual materials used.

KINESIOLOGY: ATHLETICS

■ **KINX 6 — Baseball - Men** **3.5 Units**
Degree Applicable, CSU, UC

(May be taken four times for credit)

(May be taken for option of Letter grade or Pass/NoPass)

For intercollegiate men's baseball team to provide training and competition.

43097 MTWThF 1:00pm - 3:05pm Knott, J 45B

NOTE: CRN 43097: Enrollment for intercollegiate Baseball Team members. No-cost digital textbooks or textual materials used.

■ **KINX 9 — Conditioning for Sports** **.5 Unit**
Degree Applicable, CSU, UC

(May be taken four times for credit)

(May be taken for option of Letter grade or Pass/NoPass)

Conditioning for athletes to develop muscular strength and endurance, flexibility, core training skills, and cardio fitness.

44216 TThF 5:45am - 7:05am Lepp, J POOL

8 Weeks, Week beginning 02/26/2018 ending 04/22/2018

NOTE: CRN 44216: is conditioning for intercollegiate Women's Swimming and Diving Team members. No-cost digital textbooks or textual materials used.

43096 MW 1:15pm - 2:20pm Roth, A POOL

NOTE: CRN 43096: is conditioning for intercollegiate Men's Swimming and Diving Team members. No-cost digital textbooks or textual materials used.

■ **KINX 9 — Conditioning for Sports** **1.0 Unit**
Degree Applicable, CSU, UC

(May be taken four times for credit)

(May be taken for option of Letter grade or Pass/NoPass)

Conditioning for athletes to develop muscular strength and endurance, flexibility, core training skills, and cardio fitness.

43194 TTh 8:00am - 9:25am Oliver, A 3-1FL

NOTE: CRN 43194: is conditioning for intercollegiate Women's Volleyball team members. No-cost digital textbooks or textual materials used.

■ **KINX 18 — Golf - Men** **3.5 Units**
Degree Applicable, CSU, UC

(May be taken four times for credit)

(May be taken for option of Letter grade or Pass/NoPass)

For intercollegiate men's golf team members to provide training and competition.

43284 MW 9:00am - 3:05pm Osbourne, G 45G

NOTE: CRN 43284: Enrollment for intercollegiate Men's Golf Team members. No-cost digital textbooks or textual materials used.

■ KINX 26 — Softball - Women **3.5 Units**

Degree Applicable, CSU, UC

(May be taken four times for credit)

(May be taken for option of Letter grade or Pass/NoPass)

For intercollegiate women's softball team members to provide training and competition.

43098 MTWThF 3:05pm - 5:25pm Rojas, R 45SB

NOTE: CRN 43098: Enrollment for intercollegiate Softball Team members. No-cost digital textbooks or textual materials used.**■ KINX 28 — Swimming - Men** **3.5 Units**

Degree Applicable, CSU, UC

(May be taken four times for credit)

(May be taken for option of Letter grade or Pass/NoPass)

For intercollegiate men's swimming team members to provide training and competition.

43099 MTWTh 2:05pm - 4:15pm Ruh, M POOL
and F 7:00am - 9:05am Ruh, M POOL**NOTE:** CRN 43099: Enrollment for intercollegiate Men's Swim Team members. No-cost digital textbooks or textual materials used.**■ KINX 30 — Swimming - Women** **3.5 Units**

Degree Applicable, CSU, UC

(May be taken four times for credit)

(May be taken for option of Letter grade or Pass/NoPass)

For intercollegiate women's swimming team members to provide training and competition.

43100 MTWThF 7:00am - 9:05am Jackson, C POOL

NOTE: CRN 43100: Enrollment for intercollegiate Women's Swim Team members. No-cost digital textbooks or textual materials used.**■ KINX 32 — Tennis - Men** **3.5 Units**

Degree Applicable, CSU, UC

(May be taken four times for credit)

(May be taken for option of Letter grade or Pass/NoPass)

For intercollegiate men's tennis team members to provide training and competition.

43110 MTWTh 2:30pm - 5:05pm Pawley, T 45SB

NOTE: CRN 43110: Enrollment for intercollegiate Men's Tennis Team members. First class meeting will take place in the softball bleachers. Please email Coach Pawley at tpawley@mtsac.edu if you have any questions. No-cost digital textbooks or textual materials used.**■ KINX 34 — Tennis - Women** **3.5 Units**

Degree Applicable, CSU, UC

(May be taken four times for credit)

(May be taken for option of Letter grade or Pass/NoPass)

For intercollegiate women's tennis team members to provide training and competition.

43111 MTWTh 2:30pm - 5:05pm Pawley, T 45SB

NOTE: CRN 43111: Enrollment for intercollegiate Women's Tennis Team members. First class meeting will take place in the softball bleachers. Please email Coach Pawley at tpawley@mtsac.edu if you have any questions. No-cost digital textbooks or textual materials used.**■ KINX 38 — Track and Field - Men** **3.5 Units**

Degree Applicable, CSU, UC

(May be taken four times for credit)

(May be taken for option of Letter grade or Pass/NoPass)

For intercollegiate men's track and field team members to provide training and competition.

43112 MTWThF 2:41pm - 4:51pm Kamaka, R STADIUM

NOTE: CRN 43112: Enrollment for intercollegiate Men's Track and Field Team members.**■ KINX 42 — Track and Field - Women** **3.5 Units**

Degree Applicable, CSU, UC

(May be taken four times for credit)

(May be taken for option of Letter grade or Pass/NoPass)

For intercollegiate women's track and field team members to provide training and competition.

43113 MTWThF 2:41pm - 4:51pm Todd, D STADIUM

NOTE: CRN 43113: Enrollment for intercollegiate Women's Track and Field Team members. No-cost digital textbooks or textual materials used.**■ KINX 46 — Volleyball - Women** **3.5 Units**

Degree Applicable, CSU, UC

(May be taken four times for credit)

(May be taken for option of Letter grade or Pass/NoPass)

For intercollegiate women's volleyball team members to provide training and competition.

44207 MTWThF 12:20pm - 2:40pm Oliver, A 3-124

NOTE: CRN 44207: Enrollment limited to Beach Volleyball Team members. First class meeting will be held in Gym 3.

No-cost digital textbooks or textual materials used.

■ KINX 99 — Off-Season Athletics **2.0 Units**

Degree Applicable, CSU, UC

(May be taken four times for credit)

(May be taken for option of Letter grade or Pass/NoPass)

43108 MTWTh 7:00am - 8:35am Montenegro, D POOL

NOTE: CRN 43108: Enrollment for intercollegiate Women's Water Polo Team members. No-cost digital textbooks or textual materials used.

44330 MWF 7:00am - 9:15am Ignacio, R 2-T121

NOTE: CRN 44330: Enrollment is limited to Pep Squad Team members. No-cost digital textbooks or textual materials used.

43105 MW 9:20am - 11:25am Sanchez, J 45S

and Th 6:20pm - 8:25pm Sanchez, J 45S**NOTE:** CRN 43105: Enrollment for intercollegiate Men's Soccer Team members. No-cost digital textbooks or textual materials used.

43109 MW 11:20am - 1:10pm Roth, A POOL

and TTh 6:45am - 8:00am Roth, A POOL**NOTE:** CRN 43109: Enrollment for intercollegiate Men's Water Polo Team members. No-cost digital textbooks or textual materials used.

43103 TTh 1:00pm - 2:40pm Bowen, M 45S

and W 6:30pm - 8:50pm Bowen, M 45S**NOTE:** CRN 43103: is Enrollment for intercollegiate Women's Soccer Team members. No-cost digital textbooks or textual materials used.

43104 TWTh 1:15pm - 3:15pm Maloney, C 3-1FL

NOTE: CRN 43104: Enrollment for intercollegiate Men's Basketball Team members. No-cost digital textbooks or textual materials used.

43106 TWTh 3:20pm - 5:20pm Crichlow, B 3-1FL

NOTE: CRN 43106: Enrollment for intercollegiate Women's Basketball Team members. No-cost digital textbooks or textual materials used.

43107 MTWTh 5:25pm - 6:50pm Rivera, D 27C-MAT

NOTE: CRN 43107: Enrollment for intercollegiate Men's Wrestling Team members. No-cost digital textbooks or textual materials used.**■ KINX 99 — Off-Season Athletics** **2.5 Units**

Degree Applicable, CSU, UC

(May be taken four times for credit)

(May be taken for option of Letter grade or Pass/NoPass)

43101 MW 2:45pm - 4:15pm Jastrab, R 50P

and TTh 2:45pm - 5:15pm Jastrab, R 50P**NOTE:** CRN 43101: Enrollment for intercollegiate Football Team members. No-cost digital textbooks or textual materials used.

KINESIOLOGY: FITNESS

■ **KINF 10A — Weight Training - Beginning** **.5 Units**
 Degree Applicable, CSU, UC
 (May be taken for option of Letter grade or Pass/NoPass)
 43202 arrange 2.25 hours Jastrab, R 44-1800
NOTE: CRN 42177: Students must come the first week of class for Orientation. Weight Room hours are MTWTH
 7am-9:10pm, F 7am-6:20pm. No-cost digital textbooks or textual materials used.

44469 arrange 4.75 hours Jastrab, R 44-1800
8 Weeks, Week beginning 04/23/2018 ending 06/17/2018
NOTE: CRN 44469: Students must come to Building 44 on Monday, Tuesday, or Wednesday of the first week of class for completion of Orientation. Weight Room hours are MTWTh 7:00 a.m. - 9:10 p.m., F 7:00 a.m. - 6:20 p.m. No-cost digital textbooks or textual materials used.

■ **KINF 10A — Weight Training - Beginning** **1.0 Unit**
 Degree Applicable, CSU, UC
 (May be taken for option of Letter grade or Pass/NoPass)
 43204 arrange 3.5 hours Jastrab, R 44-1800
NOTE: CRN 42181: Students must come the first week of class for Orientation. Weight Room hours are MTWTH
 7am-9:10pm, F 7am-6:20pm. No-cost digital textbooks or textual materials used.

44277 arrange 6.75 hours Jastrab, R 44-1800
8 Weeks, Week beginning 04/23/2018 ending 06/17/2018
NOTE: CRN 44277: Students must come to Building 44 on Monday, Tuesday, or Wednesday of the first week of class for completion of Orientation. Weight Room hours are MTWTh 7:00 a.m. - 9:10 p.m., F 7:00 a.m. - 6:20 p.m. No-cost digital textbooks or textual materials used.

■ **KINF 10A — Weight Training - Beginning** **2.0 Units**
 Degree Applicable, CSU, UC
 (May be taken for option of Letter grade or Pass/NoPass)
 43206 arrange 6.75 hours Jastrab, R 44-1800
NOTE: CRN 43206: Students must come the first week of class for Orientation. Weight Room hours are MTWTH 7am-9:10pm, F 7am-6:20pm. No-cost digital textbooks or textual materials used.

■ **KINF 10B — Weight Training - Intermediate** **.5 Units**
 Degree Applicable, CSU, UC
 (May be taken for option of Letter grade or Pass/NoPass)
Advisory: KINF 10A or weight training experience
 43203 arrange 2.25 hours Jastrab, R 44-1800
NOTE: CRN 43203: Students must come the first week of class for Orientation. Weight Room hours are MTWTH 7am-9:10pm, F 7am-6:20pm. No-cost digital textbooks or textual materials used.

44276 arrange 4.5 hours Jastrab, R 44-1800
8 Weeks, Week beginning 04/23/2018 ending 06/17/2018
NOTE: CRN 44276: Students must come to Building 44 on Monday, Tuesday, or Wednesday of the first week of class for completion of Orientation. Weight Room hours are MTWTh 7:00 a.m. - 9:10 p.m., F 7:00 a.m. - 6:20 p.m. No-cost digital textbooks or textual materials used.

■ **KINF 10B — Weight Training - Intermediate** **1.0 Unit**
 Degree Applicable, CSU, UC
 (May be taken for option of Letter grade or Pass/NoPass)
Advisory: KINF 10A or weight training experience
 43205 arrange 3.5 hours Jastrab, R 44-1800
NOTE: CRN 43205: Students must come the first week of class for Orientation. Weight Room hours are MTWTH 7am-9:10pm, F 7am-6:20pm. No-cost digital textbooks or textual materials used.

44278 arrange 6.75 hours Jastrab, R 44-1800
8 Weeks, Week beginning 04/23/2018 ending 06/17/2018
NOTE: CRN 44278: Students must come to Building 44 on Monday or Tuesday of the FIRST WEEK of class for completion of Orientation. Weight Room hours are MTWTh 7:00 a.m. - 9:10 p.m., F 7:00 a.m. - 6:20 p.m.
 No-cost digital textbooks or textual materials used.

■ **KINF 10B — Weight Training - Intermediate** **2.0 Units**
 Degree Applicable, CSU, UC
 (May be taken for option of Letter grade or Pass/NoPass)
Advisory: KINF 10A or weight training experience
 43207 arrange 6.75 hours Jastrab, R 44-1800
NOTE: CRN 43207: Students must come the first week of class for Orientation. Weight Room hours are MTWTH 7am-9:10pm, F 7am-6:20pm. No-cost digital textbooks or textual materials used.

■ **KINF 25 — Core Performance and Foundation Movement** **1.0 Unit**
 Degree Applicable, CSU, UC
 (May be taken for option of Letter grade or Pass/NoPass)
 Body core training and foundation movement for students interested in improving their fitness level.
 43320 TTh 8:00am - 9:25am Jackson, C 44-1600
NOTE: CRN 43320: No-cost digital textbooks or textual materials used.

■ **KINF 34A — Cardiorespiratory Training Beginning** **.5 Units**
 Degree Applicable, CSU, UC
 (May be taken for option of Letter grade or Pass/NoPass)
 Beginning individualized cardiovascular exercise for students needing to start at a fundamental level of intensity.
 43210 arrange 2.25 hours Lanaro, G 27A-2
NOTE: CRN 43210: Students must come to Building 27A, ESWC between the hours of 7:00 a.m.-3:00 p.m., 6:00 p.m.-9:00 p.m. On Monday or Tuesday during the FIRST WEEK OF THE TERM to "E" (Enter into class) and schedule your orientations, or your space will be given to a student on the Wait List. Class Open Hours: MTWThF 7:00 a.m.-3:00 p.m., MTWTh 6:00 p.m.-9:00 p.m. No-cost digital textbooks or textual materials used.

■ **KINF 34A — Cardiorespiratory Training Beginning** **1.0 Unit**
 Degree Applicable, CSU, UC
 (May be taken for option of Letter grade or Pass/NoPass)
 Beginning individualized cardiovascular exercise for students needing to start at a fundamental level of intensity.
 43212 arrange 3.5 hours Lanaro, G 27A-2
NOTE: CRN 43212: Students must come to Building 27A, ESWC between the hours of 7:00 a.m.-3:00 p.m., 6:00 p.m.-9:00 p.m. On Monday or Tuesday during the FIRST WEEK OF THE TERM to "E" (Enter into class) and schedule your orientations, or your space will be given to a student on the Wait List. Class Open Hours: MTWThF 7:00 a.m.-3:00 p.m., MTWTh 6:00 p.m.-9:00 p.m. No-cost digital textbooks or textual materials used.

■ **KINF 34A — Cardiorespiratory Training Beginning** **2.0 Units**
Degree Applicable, CSU, UC

(May be taken for option of Letter grade or Pass/NoPass)

Beginning individualized cardiovascular exercise for students needing to start at a fundamental level of intensity.

43208 arrange 6.75 hours Lanaro, G 27A-2

NOTE: CRN 43208: Students must come to Building 27A, ESWC between the hours of 7:00 a.m.-3:00 p.m., 6:00 p.m.-9:00 p.m. On Monday or Tuesday during the FIRST WEEK OF THE TERM to "E" (Enter into class) and schedule your orientations, or your space will be given to a student on the Wait List. Class Open Hours: MTWThF 7:00 a.m.-3:00 p.m., MTWTh 6:00 p.m.-9:00 p.m. No-cost digital textbooks or textual materials used.

■ **KINF 34B — Cardiorespiratory Training Intermediate** **.5 Units**
Degree Applicable, CSU, UC

(May be taken for option of Letter grade or Pass/NoPass)

Individualized cardiovascular exercise for students able to participate in aerobic activity at a moderate level of intensity.

43211 arrange 2.25 hours Lanaro, G 27A-2

NOTE: CRN 43211: Students must come to Building 27A, ESWC between the hours of 7:00 a.m.-3:00 p.m., 6:00 p.m.-9:00 p.m. On Monday or Tuesday during the FIRST WEEK OF THE TERM to "E" (Enter into class) and schedule your orientations, or your space will be given to a student on the Wait List. Class Open Hours: MTWThF 7:00 a.m.-3:00 p.m., MTWTh 6:00 p.m.-9:00 p.m. No-cost digital textbooks or textual materials used.

■ **KINF 34B — Cardiorespiratory Training Intermediate** **1.0 Unit**
Degree Applicable, CSU, UC

(May be taken for option of Letter grade or Pass/NoPass)

Individualized cardiovascular exercise for students able to participate in aerobic activity at a moderate level of intensity.

43213 arrange 3.5 hours Lanaro, G 27A-2

NOTE: CRN 43213: Students must come to Building 27A, ESWC between the hours of 7:00 a.m.-3:00 p.m., 6:00 p.m.-9:00 p.m. On Monday or Tuesday during the FIRST WEEK OF THE TERM to "E" (Enter into class) and schedule your orientations, or your space will be given to a student on the Wait List. Class Open Hours: MTWThF 7:00 a.m.-3:00 p.m., MTWTh 6:00 p.m.-9:00 p.m. No-cost digital textbooks or textual materials used.

■ **KINF 34B — Cardiorespiratory Training Intermediate** **2.0 Units**
Degree Applicable, CSU, UC

(May be taken for option of Letter grade or Pass/NoPass)

Individualized cardiovascular exercise for students able to participate in aerobic activity at a moderate level of intensity.

43209 arrange 6.75 hours Lanaro, G 27A-2

NOTE: CRN 43209: Students must come to Building 27A, ESWC between the hours of 7:00 a.m.-3:00 p.m., 6:00 p.m.-9:00 p.m. On Monday or Tuesday during the FIRST WEEK OF THE TERM to "E" (Enter into class) and schedule your orientations, or your space will be given to a student on the Wait List. Class Open Hours: MTWThF 7:00 a.m.-3:00 p.m., MTWTh 6:00 p.m.-9:00 p.m. No-cost digital textbooks or textual materials used.

■ **KINF 36A — Circuit Training Beginning** **.5 Units**
Degree Applicable, CSU, UC

(May be taken for option of Letter grade or Pass/NoPass)

Beginning Circuit Training for individuals with little or no weight training experience.

43214 arrange 2.25 hours Lanaro, G 27A-2

NOTE: CRN 43214: Students must come to Building 27A, ESWC between the hours of 7:00 a.m.-3:00 p.m., 6:00 p.m.-9:00 p.m. On Monday or Tuesday during the FIRST WEEK OF THE TERM to "E" (Enter into class) and schedule your orientations, or your space will be given to a student on the Wait List. Class Open Hours: MTWThF 7:00 a.m.-3:00 p.m., MTWTh 6:00 p.m.-9:00 p.m. No-cost digital textbooks or textual materials used.

44281 arrange 4.5 hours Lanaro, G 27A-2
8 Weeks, Week beginning 04/23/2018 ending 06/17/2018

NOTE: CRN 44281: Students must come to Building 27A, ESWC between the hours of 7:00 a.m.-3:00 p.m., 6:00 p.m.-9:00 p.m. On Monday or Tuesday during the FIRST WEEK OF THE TERM to "E" (Enter into class) and schedule your orientations, or your space will be given to a student on the Wait List. Class Open Hours: MTWThF 7:00 a.m.-3:00 p.m., MTWTh 6:00 p.m.-9:00 p.m. No-cost digital textbooks or textual materials used.

■ **KINF 36A — Circuit Training Beginning** **1.0 Unit**
Degree Applicable, CSU, UC

(May be taken for option of Letter grade or Pass/NoPass)

Beginning Circuit Training for individuals with little or no weight training experience.

43216 arrange 3.5 hours Lanaro, G 27A-2

NOTE: CRN 43216: Students must come to Building 27A, ESWC between the hours of 7:00 a.m.-3:00 p.m., 6:00 p.m.-9:00 p.m. On Monday or Tuesday during the FIRST WEEK OF THE TERM to "E" (Enter into class) and schedule your orientations, or your space will be given to a student on the Wait List. Class Open Hours: MTWThF 7:00 a.m.-3:00 p.m., MTWTh 6:00 p.m.-9:00 p.m. No-cost digital textbooks or textual materials used.

44283 arrange 6.75 hours STAFF 27A-2
8 Weeks, Week beginning 04/23/2018 ending 06/17/2018

NOTE: CRN 44283: Students must come to Building 27A, ESWC between the hours of 7:00 a.m.-3:00 p.m., 6:00 p.m.-9:00 p.m. On Monday or Tuesday during the FIRST WEEK OF THE TERM to "E" (Enter into class) and schedule your orientations, or your space will be given to a student on the Wait List. Class Open Hours: MTWThF 7:00 a.m.-3:00 p.m., MTWTh 6:00 p.m.-9:00 p.m. No-cost digital textbooks or textual materials used.

■ **KINF 36A — Circuit Training Beginning** **2.0 Units**
Degree Applicable, CSU, UC

(May be taken for option of Letter grade or Pass/NoPass)

Beginning Circuit Training for individuals with little or no weight training experience.

43218 arrange 6.75 hours Lanaro, G 27A-2

NOTE: CRN 43218: Students must come to Building 27A, ESWC between the hours of 7:00 a.m.-3:00 p.m., 6:00 p.m.-9:00 p.m. On Monday or Tuesday during the FIRST WEEK OF THE TERM to "E" (Enter into class) and schedule your orientations, or your space will be given to a student on the Wait List. Class Open Hours: MTWThF 7:00 a.m.-3:00 p.m., MTWTh 6:00 p.m.-9:00 p.m. No-cost digital textbooks or textual materials used.

■ KINF 36B — Circuit Training Intermediate .5 Units

Degree Applicable, CSU, UC

(May be taken for option of Letter grade or Pass/NoPass)

Circuit training for students with previous strength training experience.

43215 arrange 2.25 hours Lanaro, G 27A-2

NOTE: CRN 43215: Students must come to Building 27A, ESWC between the hours of 7:00 a.m.-3:00 p.m., 6:00 p.m.-9:00 p.m. On Monday or Tuesday during the FIRST WEEK OF THE TERM to "E" (Enter into class) and schedule your orientations, or your space will be given to a student on the Wait List. Class Open Hours: MTWThF 7:00 a.m.-3:00 p.m., MTWTh 6:00 p.m.-9:00 p.m. No-cost digital textbooks or textual materials used.

44282 arrange 4.5 hours Lanaro, G 27A-2

8 Weeks, Week beginning 04/23/2018 ending 06/17/2018

NOTE: CRN 44282: Students must come to Building 27A, ESWC between the hours of 7:00 a.m.-3:00 p.m., 6:00 p.m.-9:00 p.m. On Monday or Tuesday during the FIRST WEEK OF THE TERM to "E" (Enter into class) and schedule your orientations, or your space will be given to a student on the Wait List. Class Open Hours: MTWThF 7:00 a.m.-3:00 p.m., MTWTh 6:00 p.m.-9:00 p.m. No-cost digital textbooks or textual materials used.

■ KINF 36B — Circuit Training Intermediate 1.0 Unit

Degree Applicable, CSU, UC

(May be taken for option of Letter grade or Pass/NoPass)

Circuit training for students with previous strength training experience.

43217 arrange 3.4 hours Lanaro, G 27A-2

NOTE: CRN 43217: Students must come to Building 27A, ESWC between the hours of 7:00 a.m.-3:00 p.m., 6:00 p.m.-9:00 p.m. On Monday or Tuesday during the FIRST WEEK OF THE TERM to "E" (Enter into class) and schedule your orientations, or your space will be given to a student on the Wait List. Class Open Hours: MTWThF 7:00 a.m.-3:00 p.m., MTWTh 6:00 p.m.-9:00 p.m. No-cost digital textbooks or textual materials used.

44284 arrange 6.75 hours Lanaro, G 27A-2

8 Weeks, Week beginning 04/23/2018 ending 06/17/2018

NOTE: CRN 44284: Students must come to Building 27A, ESWC between the hours of 7:00 a.m.-3:00 p.m., 6:00 p.m.-9:00 p.m. On Monday or Tuesday during the FIRST WEEK OF THE TERM to "E" (Enter into class) and schedule your orientations, or your space will be given to a student on the Wait List. Class Open Hours: MTWThF 7:00 a.m.-3:00 p.m., MTWTh 6:00 p.m.-9:00 p.m. No-cost digital textbooks or textual materials used.

■ KINF 36B — Circuit Training Intermediate 2.0 Units

Degree Applicable, CSU, UC

(May be taken for option of Letter grade or Pass/NoPass)

Circuit training for students with previous strength training experience.

43219 arrange 6.75 hours Lanaro, G 27A-2

NOTE: CRN 43219: Students must come to Building 27A, ESWC between the hours of 7:00 a.m.-3:00 p.m., 6:00 p.m.-9:00 p.m. On Monday or Tuesday during the FIRST WEEK OF THE TERM to "E" (Enter into class) and schedule your orientations, or your space will be given to a student on the Wait List. Class Open Hours: MTWThF 7:00 a.m.-3:00 p.m., MTWTh 6:00 p.m.-9:00 p.m. No-cost digital textbooks or textual materials used.

■ KINF 38A — Aerobics-Beginning .5 Unit

Degree Applicable, CSU, UC

(May be taken for option of Letter grade or Pass/NoPass)

Beginning group exercise to improve cardiovascular fitness using aerobic activity.

43220 F 9:45am - 11:50am Hackmann, D 27A-3

NOTE: CRN 43220: No-cost digital textbooks or textual materials used.

43273 M 7:00pm - 9:05pm Mascarenas, A 27A-3

NOTE: CRN 43273: No-cost digital textbooks or textual materials used.

43222 W 7:00pm - 9:05pm Mascarenas, A 27A-3

NOTE: CRN 43222: No-cost digital textbooks or textual materials used.**■ KINF 38A — Aerobics-Beginning 1.0 Unit**

Degree Applicable, CSU, UC

(May be taken for option of Letter grade or Pass/NoPass)

Beginning group exercise to improve cardiovascular fitness using aerobic activity.

43224 MW 8:00am - 9:25am Jones, L 27A-3

NOTE: CRN 43224: No-cost digital textbooks or textual materials used.

43226 TTh 8:00am - 9:25am Hackmann, D 27A-3

NOTE: CRN 43226: No-cost digital textbooks or textual materials used.

43228 MW 9:45am - 11:10am Jones, L 27A-3

NOTE: CRN 43228: No-cost digital textbooks or textual materials used.

43230 TTh 9:45am - 11:10am Hackmann, D 27A-3

NOTE: CRN 43230: No-cost digital textbooks or textual materials used.

43232 MW 11:30am - 12:55pm Jones, L 27A-3

NOTE: CRN 43232: No-cost digital textbooks or textual materials used.

43234 TTh 11:30am - 12:55pm Anello, A 27A-3

NOTE: CRN 43234: No-cost digital textbooks or textual materials used.

43236 TTh 1:15pm - 2:40pm Anello, A 27A-3

NOTE: CRN 43236: No-cost digital textbooks or textual materials used.**■ KINF 38B — Aerobics .5 Unit**

Degree Applicable, CSU, UC

(May be taken for option of Letter grade or Pass/NoPass)

Group aerobic exercise for students with experience in group fitness and able to exercise at moderate levels of aerobic activity.

43221 F 9:45am - 11:50am Hackmann, D 27A-3

NOTE: CRN 43221: No-cost digital textbooks or textual materials used.

43274 M 7:00pm - 9:05pm Mascarenas, A 27A-3

NOTE: CRN 43274: No-cost digital textbooks or textual materials used.

43223 W 7:00pm - 9:05pm Mascarenas, A 27A-3

NOTE: CRN 43223: No-cost digital textbooks or textual materials used.**■ KINF 38B — Aerobics 1.0 Unit**

Degree Applicable, CSU, UC

(May be taken for option of Letter grade or Pass/NoPass)

Group aerobic exercise for students with experience in group fitness and able to exercise at moderate levels of aerobic activity.

43225 MW 8:00am - 9:25am Jones, L 27A-3

NOTE: CRN 43225: No-cost digital textbooks or textual materials used.

43227 TTh 8:00am - 9:25am Hackmann, D 27A-3

NOTE: CRN 43227: No-cost digital textbooks or textual materials used.

43229 MW 9:45am - 11:10am Jones, L 27A-3

NOTE: CRN 43229: No-cost digital textbooks or textual materials used.

43231 TTh 9:45am - 11:10am Hackmann, D 27A-3

NOTE: CRN 43231: No-cost digital textbooks or textual materials used.

43233 MW 11:30am - 12:55pm Jones, L 27A-3

NOTE: CRN 43233: No-cost digital textbooks or textual materials used.

43235 TTh 11:30am - 12:55pm Anello, A 27A-3

NOTE: CRN 43235: No-cost digital textbooks or textual materials used.

43237 TTh 1:15pm - 2:40pm Anello, A 27A-3

NOTE: CRN 43237: No-cost digital textbooks or textual materials used.**■ KINF 51A — Agility Test Preparation Law and Fire 1.0 Unit**

- Beginning

Degree Applicable, CSU

(May be taken for option of Letter grade or Pass/NoPass)

Physical agility skills specific for law enforcement and fire technology. There may be off-campus assignments.

43238 MW 7:30am - 9:35am Ward, E 50FIRE

NOTE: CRN 43238: No-cost digital textbooks or textual materials used.

43240 MW 9:45am - 11:50am Ward, E 50FIRE

NOTE: CRN 43240: No-cost digital textbooks or textual materials used.

43242 MW 4:30pm - 6:35pm Morris, J 50FIRE

NOTE: CRN 43242: No-cost digital textbooks or textual materials used.

■ **KINF 51B — Agility Test Preparation Law and Fire - Intermediate** **1.0 Unit**

Degree Applicable, CSU

(May be taken for option of Letter grade or Pass/NoPass)

Advisories: KINF 51A

Designed to enhance competence in physical agility testing for individuals who have had instruction in primary agility training.

43239 MW 7:30am - 9:35am Ward, E 50FIRE

NOTE: CRN 43239: No-cost digital textbooks or textual materials used.

43241 MW 9:45am - 11:50am Ward, E 50FIRE

NOTE: CRN 43241: No-cost digital textbooks or textual materials used.

43243 MW 4:30pm - 6:35pm Morris, J 50FIRE

NOTE: CRN 43243: No-cost digital textbooks or textual materials used.

■ **KINF 52A — Fitness and Conditioning for Law and Fire - Beginning** **1.0 Unit**

Degree Applicable, CSU

(May be taken for option of Letter grade or Pass/NoPass)

Components of fitness used to perform agility tasks in the fields of law enforcement and fire technology.

43246 MW 7:30am - 9:35am Uiagalelei, I LOT50G

NOTE: CRN 43246: No-cost digital textbooks or textual materials used.

■ **KINF 52A — Fitness and Conditioning for Law and Fire - Beginning** **1.0 Unit**

Degree Applicable, CSU

(May be taken for option of Letter grade or Pass/NoPass)

Components of fitness used to perform agility tasks in the fields of law enforcement and fire technology.

43244 TTh 7:30am - 9:35am Ward, E LOT50G

NOTE: CRN 43244: No-cost digital textbooks or textual materials used.

■ **KINF 52B — Fitness and Conditioning for Law and Fire - Intermediate** **1.0 Unit**

Degree Applicable, CSU

(May be taken for option of Letter grade or Pass/NoPass)

Advisory: KINF 52A

Principles of exercise used to enhance fitness performance in the fields of law enforcement and fire technology.

43247 MW 7:30am - 9:35am Uiagalelei, I LOT50G

NOTE: CRN 43247: No-cost digital textbooks or textual materials used.

43245 TTh 7:30am - 9:35am Ward, E LOT50G

NOTE: CRN 43245: No-cost digital textbooks or textual materials used.

■ **KINF 53 — Physical Training for the Basic Fire Academy** **2.5 Units**

Degree Applicable, CSU

(May be taken for option of Letter grade or Pass/NoPass)

44161 MTWThF 5:00am - 7:05am Morris, J LOT50G

13 Weeks, Week beginning 02/26/2018 ending 05/27/2018

NOTE: CRN 44161: No-cost digital textbooks or textual materials used.

KINESIOLOGY: INDIVIDUAL

■ **KINI 4A — Badminton - Beginning** **1.0 Unit**

Degree Applicable, CSU, UC

(May be taken for option of Letter grade or Pass/NoPass)

43157 TTh 8:00am - 9:25am Maloney, C 3-1FL

NOTE: CRN 43157: No-cost digital textbooks or textual materials used.

43185 F 8:30am - 11:40am Whitlock, M 3-1FL

NOTE: CRN: No-cost digital textbooks or textual materials used.

43276 M 6:10pm - 9:20pm Michel, M 3-1FL

NOTE: CRN 43276: No-cost digital textbooks or textual materials used.

■ **KINI 4B — Badminton - Intermediate** **1.0 Unit**

Degree Applicable, CSU, UC

(May be taken for option of Letter grade or Pass/NoPass)

43158 TTh 8:00am - 9:25am Maloney, C 3-1FL

NOTE: CRN 43158: No-cost digital textbooks or textual materials used.

43186 F 8:30am - 11:40am Whitlock, M 3-1FL

43277 M 6:10pm - 9:20pm Michel, M 3-1FL

NOTE: CRN 43277: No-cost digital textbooks or textual materials used.

■ **KINI 18A — Golf - Beginning** **1.0 Unit**

Degree Applicable, CSU, UC

(May be taken for option of Letter grade or Pass/NoPass)

43161 MW 11:30am - 12:55pm Parker, S 45G

NOTE: CRN 43161: No-cost digital textbooks or textual materials used.

Students may be required to pay for range balls and greens fees.

43279 TTh 11:30am - 12:55pm Osbourne, G 45G

NOTE: CRN 43279: No-cost digital textbooks or textual materials used.

Students may be required to pay for range balls and greens fees.

■ **KINI 18B — Golf - Intermediate** **1.0 Unit**

Degree Applicable, CSU, UC

(May be taken for option of Letter grade or Pass/NoPass)

Instruction to individuals with previous golf experience. Golf clubs and off site classes required.

43162 MW 11:30am - 12:55pm Parker, S 45G

NOTE: CRN 43162: No-cost digital textbooks or textual materials used.

Students may be required to pay for range balls and greens fees.

43280 TTh 11:30am - 12:55pm Osbourne, G 45G

NOTE: CRN 43280: No-cost digital textbooks or textual materials used.

Students may be required to pay for range balls and greens fees.

43314 MW 3:00pm - 4:25pm Guevara, A 45G

NOTE: CRN 43314: No-cost digital textbooks or textual materials used.

Students may be required to pay for range balls and greens fees.

■ **KINI 18C — Golf - Advanced** **1.0 Unit**

Degree Applicable, CSU, UC

(May be taken for option of Letter grade or Pass/NoPass)

Instruction and practice for the proficient golfer (Sub 15 Handicap). Clubs and off-campus classes required.

43319 MW 3:00pm - 4:25pm Guevara, A 45G

NOTE: CRN 43319: No-cost digital textbooks or textual materials used.

Students may be required to pay for range balls and greens fees.

■ **KINI 25 — Mixed Martial Arts** **1.0 Unit**

Degree Applicable, CSU, UC

(May be taken for option of Letter grade or Pass/NoPass)

The sport of mixed martial arts integrating striking and close-combat martial arts.

43163 TTh 1:15pm - 2:40pm Del Castillo, S 27C-MAT

NOTE: CRN 43163: No-cost digital textbooks or textual materials used.

■ **KINI 29 — Self Defense/Martial Arts** **1.0 Unit**

Degree Applicable, CSU, UC

(May be taken for option of Letter grade or Pass/NoPass)

Basic concepts of self-defense and martial arts.

43164 MW 9:45am - 11:10am Rivas, M 27C-MAT

NOTE: CRN 43164: No-cost digital textbooks or textual materials used.

■ **KINI 30A — Filipino Martial Arts - Beginning** **1.0 Unit**

Degree Applicable, CSU, UC

(May be taken for option of Letter grade or Pass/NoPass)

Filipino martial art of Esgrima and Arnis.

43196 TTh 11:30am - 12:55pm Del Castillo, S 27C-MAT

NOTE: CRN 43196: No-cost digital textbooks or textual materials used.

■ **KINI 30B — Filipino Martial Arts - Intermediate** **1.0 Unit**

Degree Applicable, CSU, UC

(May be taken for option of Letter grade or Pass/NoPass)

43165 TTh 11:30am - 12:55pm Del Castillo, S 27C-MAT

NOTE: CRN 43165: No-cost digital textbooks or textual materials used.

■ KINI 31A — JiuJitsu - Beginning **1.0 Unit**

Degree Applicable, CSU, UC

(May be taken for option of Letter grade or Pass/NoPass)

Brazilian JiuJitsu: submission grappling, basic positions, strategy, competition. Students provide own uniform.

43166 MW 11:30am - 12:55pm Rivera, D 27C-MAT

NOTE: CRN 43166: No-cost digital textbooks or textual materials used.

43167 MW 3:00pm - 4:25pm Rivera, D 27C-MAT

NOTE: CRN 43167: No-cost digital textbooks or textual materials used.**■ KINI 33A — Kickboxing Beginning** **1.0 Unit**

Degree Applicable, CSU, UC

(May be taken for option of Letter grade or Pass/NoPass)

Presents the martial sport of kickboxing. Designed for students with little or no experience

43288 MW 8:00am - 9:25am Rivas, M 27C-MAT

NOTE: CRN 43288: No-cost digital textbooks or textual materials used.

43292 TTh 9:45am - 11:10am Flores, C 27C-MAT

NOTE: CRN 43292: No-cost digital textbooks or textual materials used.

43290 MW 1:15pm - 2:40pm Rivas, M 27C-MAT

NOTE: CRN 43290: No-cost digital textbooks or textual materials used.**43286 MW 5:25pm - 6:50pm Dominguez, R 27A-108****NOTE:** CRN 43286: No-cost digital textbooks or textual materials used.**43363 TTh 5:25pm - 6:50pm Wilson, L 27A-108****NOTE:** CRN 43363: No-cost digital textbooks or textual materials used.**■ KINI 33B — Kickboxing Intermediate** **1.0 Unit**

Degree Applicable, CSU, UC

(May be taken four times for credit)

(May be taken for option of Letter grade or Pass/NoPass)

Prerequisite: KINI 33A

Intermediate Kickboxing techniques.

43289 MW 8:00am - 9:25am Rivas, M 27C-MAT

NOTE: CRN 43289: No-cost digital textbooks or textual materials used.

43293 TTh 9:45am - 11:10am Flores, C 27C-MAT

NOTE: CRN 43293: No-cost digital textbooks or textual materials used.

43291 MW 1:15pm - 2:40pm Rivas, M 27C-MAT

NOTE: CRN 43291: No-cost digital textbooks or textual materials used.**43287 MW 5:25pm - 6:50pm Dominguez, R 27A-108****NOTE:** CRN 43287: No-cost digital textbooks or textual materials used.**43364 TTh 5:25pm - 6:50pm Wilson, L 27A-108****NOTE:** CRN 43364: No-cost digital textbooks or textual materials used.**■ KINI 37A — Tai Chi Chuan - Beginning** **1.0 Unit**

Degree Applicable, CSU, UC

(May be taken for option of Letter grade or Pass/NoPass)

Fundamentals of Tai Chi Chuan as a martial art exercise for health and fitness, meditation, relaxation, and self-defense.

43168 MW 11:30am - 12:55pm Rivas, M 27A-108

NOTE: CRN 43168: No-cost digital textbooks or textual materials used.**■ KINI 50A — Yoga** **1.0 Unit**

Degree Applicable, CSU, UC

(May be taken for option of Letter grade or Pass/NoPass)

Yoga postures, breathing techniques, and relaxation strategies.

43198 MW 8:00am - 9:25am Flores, C 27A-108

NOTE: CRN 43198: No-cost digital textbooks or textual materials used.

43324 MW 8:00am - 9:25am Wilder-Mazurie, D 45-1411

NOTE: CRN 43324: No-cost digital textbooks or textual materials used.

43169 TTh 8:00am - 9:25am Del Castillo, S 27A-108

NOTE: CRN 43169: No-cost digital textbooks or textual materials used.

43170 MW 9:45am - 11:10am Flores, C 27A-108

NOTE: CRN 43170: No-cost digital textbooks or textual materials used.

43325 MW 9:45am - 11:10am Wilder-Mazurie, D 45-1411

NOTE: CRN 43325: No-cost digital textbooks or textual materials used.

43171 TTh 9:45am - 11:10am Del Castillo, S 27A-108

NOTE: CRN 43171: No-cost digital textbooks or textual materials used.

43172 TTh 11:30am - 12:55pm Rivera, D 27A-108

NOTE: CRN 43172: No-cost digital textbooks or textual materials used.

43184 MW 1:15pm - 2:40pm Dominguez, R 27A-108

NOTE: CRN 43184: No-cost digital textbooks or textual materials used.**43282 MW 7:00pm - 8:25pm Dominguez, R 27A-108****NOTE:** CRN 43282: No-cost digital textbooks or textual materials used.**43362 TTh 7:00pm - 8:25pm Dominguez, R 27A-108****NOTE:** CRN 43362: No-cost digital textbooks or textual materials used.**KINESIOLOGY: TEAM SPORT****■ KINS 2A — Basketball Beginning** **.5 Unit**

Degree Applicable, CSU, UC

(May be taken for option of Letter grade or Pass/NoPass)

Designed to teach skills, fundamentals, rules and strategies for team play in basketball for the beginner.

43250 W 6:00pm - 8:05pm Crichlow, B 3-1FL**NOTE:** CRN 43250: No-cost digital textbooks or textual materials used.**■ KINS 2A — Basketball Beginning** **1.0 Unit**

Degree Applicable, CSU, UC

(May be taken for option of Letter grade or Pass/NoPass)

Designed to teach skills, fundamentals, rules and strategies for team play in basketball for the beginner.

43252 MW 8:00am - 9:25am Michel, M 3-1FL

NOTE: CRN 43252: No-cost digital textbooks or textual materials used.

43254 TTh 9:45am - 11:10am Maloney, C 3-1FL

NOTE: CRN 43254: No-cost digital textbooks or textual materials used.**43248 T 6:10pm - 9:20pm Michel, M 3-1FL****NOTE:** CRN 43248: No-cost digital textbooks or textual materials used.**■ KINS 2B — Basketball Intermediate** **.5 Unit**

Degree Applicable, CSU, UC

(May be taken for option of Letter grade or Pass/NoPass)

Skills, fundamentals, rules and strategies for team play in basketball for students with previous-experience.

43251 W 6:00pm - 8:05pm Crichlow, B 3-1FL**NOTE:** CRN 43251: No-cost digital textbooks or textual materials used.**■ KINS 2B — Basketball Intermediate** **1.0 Unit**

Degree Applicable, CSU, UC

(May be taken for option of Letter grade or Pass/NoPass)

Skills, fundamentals, rules and strategies for team play in basketball for students with previous-experience.

43253 MW 8:00am - 9:25am Michel, M 3-1FL

NOTE: CRN 43253: No-cost digital textbooks or textual materials used.

43255 TTh 9:45am - 11:10am Maloney, C 3-1FL

NOTE: CRN 43255: No-cost digital textbooks or textual materials used.**43249 T 6:10pm - 9:20pm Michel, M 3-1FL****NOTE:** CRN 43249: No-cost digital textbooks or textual materials used.

■ KINS 10A — Beginning Soccer .5 Unit

Degree Applicable, CSU, UC

(May be taken for option of Letter grade or Pass/NoPass)

Fundamental technical skills and tactics to students with little or no soccer ability.

43256 T 7:00pm - 9:05pm Martinez, G 45S**NOTE:** CRN 43256: No-cost digital textbooks or textual materials used.**43258 W 7:00pm - 9:05pm Suarez, M 45S****NOTE:** CRN 43258: No-cost digital textbooks or textual materials used.**■ KINS 10A — Beginning Soccer 1.0 Unit**

Degree Applicable, CSU, UC

(May be taken for option of Letter grade or Pass/NoPass)

Fundamental technical skills and tactics to students with little or no soccer ability.

43266 MW 9:45am - 11:10am Fernandez, M 45S**NOTE:** CRN 43266: No-cost digital textbooks or textual materials used.**43264 TTh 9:45am - 11:10am Vascones, Y 45S****NOTE:** CRN 43264: No-cost digital textbooks or textual materials used.**43260 MW 11:30am - 12:55pm Sanchez, J 45S****NOTE:** CRN 43260: No-cost digital textbooks or textual materials used.**43262 TTh 11:30am - 12:55pm Vascones, Y 45S****NOTE:** CRN 43262: No-cost digital textbooks or textual materials used.**■ KINS 10B — Soccer Intermediate .5 Unit**

Degree Applicable, CSU, UC

(May be taken for option of Letter grade or Pass/NoPass)

Advisory: KINS 10A

Designed to improve competence in technical and tactical skills for students who have had instruction in soccer.

43257 T 7:00pm - 9:05pm Martinez, G 45S**NOTE:** CRN 43257: No-cost digital textbooks or textual materials used.**43259 W 7:00pm - 9:05pm Suarez, M 45S****NOTE:** CRN 43259: No-cost digital textbooks or textual materials used.**■ KINS 10B — Soccer Intermediate 1.0 Unit**

Degree Applicable, CSU, UC

(May be taken for option of Letter grade or Pass/NoPass)

Advisory: KINS 10A

Designed to improve competence in technical and tactical skills for students who have had instruction in soccer.

43267 MW 9:45am - 11:10am Fernandez, M 45S**NOTE:** CRN 43267: No-cost digital textbooks or textual materials used.**43265 TTh 9:45am - 11:10am Vascones, Y 45S****NOTE:** CRN 43265: No-cost digital textbooks or textual materials used.**43261 MW 11:30am - 12:55pm Sanchez, J 45S****NOTE:** CRN 43261: No-cost digital textbooks or textual materials used.**43263 TTh 11:30am - 12:55pm Vascones, Y 45S****NOTE:** CRN 43263: No-cost digital textbooks or textual materials used.**■ KINS 16 — Softball 1.0 Unit**

Degree Applicable, CSU, UC

(May be taken for option of Letter grade or Pass/NoPass)

43201 TTh 9:45am - 11:10am Mascarenas, A 45SB**NOTE:** CRN 43201: No-cost digital textbooks or textual materials used.**■ KINS 24A — Volleyball - Beginning 1.0 Unit**

Degree Applicable, CSU, UC

(May be taken for option of Letter grade or Pass/NoPass)

Techniques and strategies of volleyball including passing, setting, hitting, and serving.

43159 MW 9:45am - 11:10am Lackey, K 3-1FL**NOTE:** CRN 43159: No-cost digital textbooks or textual materials used.**43321 M 3:00pm - 6:10pm Lackey, K 3-1FL****NOTE:** CRN 43321: No-cost digital textbooks or textual materials used.**43155 Th 6:10pm - 9:20pm Lackey, K 3-1FL****NOTE:** CRN 43155: No-cost digital textbooks or textual materials used.**■ KINS 24B — Volleyball - Intermediate 1.0 Unit**

Degree Applicable, CSU, UC

(May be taken for option of Letter grade or Pass/NoPass)

43160 MW 9:45am - 11:10am Lackey, K 3-1FL**NOTE:** CRN 43160: No-cost digital textbooks or textual materials used.**43322 M 3:00pm - 6:10pm Lackey, K 3-1FL****NOTE:** CRN 43322: No-cost digital textbooks or textual materials used.**43156 Th 6:10pm - 9:20pm Lackey, K 3-1FL****NOTE:** CRN 43156: No-cost digital textbooks or textual materials used.**■ KINS 24C — Volleyball - Advanced 1.0 Unit**

Degree Applicable, CSU, UC

(May be taken for option of Letter grade or Pass/NoPass)

43278 MW 9:45am - 11:10am Lackey, K 3-1FL**NOTE:** CRN 43278: No-cost digital textbooks or textual materials used.**43323 M 3:00pm - 6:10pm Lackey, K 3-1FL****NOTE:** CRN 43323: No-cost digital textbooks or textual materials used.**43176 Th 6:10pm - 9:20pm Lackey, K 3-1FL****NOTE:** CRN 43176: No-cost digital textbooks or textual materials used.**KINESIOLOGY: THEORY****■ KIN 3 — First Aid and CPR 3.0 Units**

(C-ID KIN 101)

Degree Applicable, CSU, UC

Advisory: Eligibility for ENGL 68

American Red Cross First Aid and CPR Certificates can be earned.

43199 MW 8:00am - 9:25am Todd, J 27A-106**43130 TTh 8:00am - 9:25am Rojas, R 27A-106****44340 F 8:00am - 11:20am Knott, J 27A-106****43131 MW 9:45am - 11:10am Todd, J 27A-106****43132 TTh 9:45am - 11:10am Rojas, R 27A-106****43133 MW 11:30am - 12:55pm Jackson, C 27A-106****43179 TTh 11:30am - 12:55pm Parker, S 27A-106****43315 MW 1:15pm - 2:40pm Purper, K 27A-106****43281 TTh 1:15pm - 2:40pm Parker, S 27A-106****43178 M 6:15pm - 9:25pm Rojas, R 27A-106****43134 T 6:15pm - 9:25pm Parker, S 27A-106****43195 Th 6:15pm - 9:25pm Purper, K 27A-106****■ KIN 5 — Advanced First Aid/CPR/Emergency Response 3.0 Units**

Degree Applicable, CSU

Advisory: Eligibility for ENGL 68

First responder training in FA/CPR. Upon successful completion, ARC certificates for the Professional Rescuer are earned

43135 MW 4:45pm - 6:10pm Todd, J 27A-106**■ KIN 13 — Sports Officiating 3.0 Units**

Degree Applicable, CSU, UC

Rules, regulations and career opportunities of various team and individual sports.

43154 TTh 8:00am - 9:25am Crichlow, B 45-1462**43180 MW 11:30am - 12:55pm Crichlow, B 45-1462****■ KIN 15 — Administration of Fitness Programs 2.0 Units**

Degree Applicable, CSU

(May be taken for option of Letter grade or Pass/NoPass)

Leadership training and administrative skills related to fitness specialists, personal trainers and physical educators.

43269 Th 7:30pm - 9:35pm Merrill, J 27A-109**■ KIN 17 — Introduction to Kinesiology 3.0 Units**

Degree Applicable, CSU, UC

(May be taken for option of Letter grade or Pass/NoPass)

Kinesiology as a profession and academic discipline. Explores sub-disciplines, philosophy, scientific basis and analysis.

43141 TTh 9:45am - 11:10am Lanaro, G 45-1462**43175 MW 1:15pm - 2:40pm Crichlow, B 45-1462****43283 MW 1:15pm - 2:40pm Rivera, D 21J-2**

■ **KIN 19 — Introduction to Care/Prevention of Activity/Sports -Related Injuries** **3.0 Units**

Degree Applicable, CSU, UC

Techniques and procedures for prevention and treatment of activity and sports-related injuries.

43140 T 7:00pm - 10:10pm Landas, M 45-1462

■ **KIN 24 — Applied Kinesiology** **2.0 Units**

Degree Applicable, CSU

(May be taken for option of Letter grade or Pass/NoPass)

The study of movement as it relates to exercise and the interrelationships of body segments involved in human movement activity.

43181 MW 3:20pm - 4:25pm STAFF 27A-109

43268 Th 5:15pm - 7:20pm Pula, E 27A-109

■ **KIN 34 — Fitness for Living** **3.0 Units**

Degree Applicable, CSU, UC

Survey and analysis of the components of fitness. Effects of fitness, stress management, nutrition and weight control on health.

43142 MW 8:00am - 9:25am Kamaka, R 27A-109

43144 TTh 8:00am - 9:25am Purcell, R 27A-109

43317 MW 9:45am - 11:10am Oliver, A 45-1462

43147 TTh 9:45am - 11:10am Bowen, M TBA

43151 TTh 9:45am - 11:10am Parker, S 27A-109

43183 TTh 9:45am - 11:10am Sanchez, J 44-1900

43150 MW 11:30am - 12:55pm Maloney, C 27A-109

43145 TTh 11:30am - 12:55pm Sanchez, J 27A-109

43152 TTh 11:30am - 12:55pm Bowen, M 45-1462

43146 MW 1:15pm - 2:40pm Parker, S 27A-109

43143 TTh 1:15pm - 2:40pm STAFF 27A-109

43200 TTh 1:15pm - 2:40pm STAFF 45-1462

44228 MW 3:00pm - 6:10pm Hackmann, D TBA

8 Weeks, Week beginning 04/23/2018 ending 06/17/2018

43148 W 3:00pm - 6:10pm STAFF 45-1462

43318 M 6:20pm - 9:30pm Oliver, A 27A-109

43149 Th 6:20pm - 9:30pm Maloney, C 45-1462

44285 arrange 3.38 hours Bowen, M ONLINE

NOTE: CRN 44285 is a Distance Learning Online Class.

How to Begin Course: Log into Canvas through <http://myportal.mtsac.edu> and click on CRN for your DL course. **NOTE:** Some courses may not be activated until the start of the term. If you cannot locate your DL course in Canvas when the term starts, contact the professor.

Professor contact info: Email Professor Bowen at either: mbowen@mtsac.edu, through Student Detail Schedule or Canvas at MyMtSAC Portal.

Students must use their Mt. SAC e-mail account and be aware of course commitment and student expectations described at <http://www.mtsac.edu/instruction/learning/distlearn/>

To prepare for a successful online learning experience, see helpful short videos at <http://www.mtsac.edu/distancelearning/quiz/>

44286 arrange 6.75 hours Knott-Silva, T ONLINE

8 Weeks, Week beginning 02/26/2018 ending 04/22/2018

NOTE: CRN 44286 is a Distance Learning Online Class.

How to Begin Course: Log into Canvas through <http://myportal.mtsac.edu> and click on CRN for your DL course. **NOTE:** Some courses may not be activated until the start of the term. If you cannot locate your DL course in Canvas when the term starts, contact the professor.

Professor contact info: Email Professor Bowen at either: mbowen@mtsac.edu, through Student Detail Schedule or Canvas at MyMtSAC Portal.

Students must use their Mt. SAC e-mail account and be aware of course commitment and student expectations described at <http://www.mtsac.edu/instruction/learning/distlearn/>

To prepare for a successful online learning experience, see helpful short videos at <http://www.mtsac.edu/distancelearning/quiz/>

44287 arrange 6.75 hours Bowen, M ONLINE
8 Weeks, Week beginning 04/23/2018 ending 06/17/2018

NOTE: CRN 44287 is a Distance Learning Online Class.

How to Begin Course: Log into Canvas through <http://myportal.mtsac.edu> and click on CRN for your DL course. **NOTE:** Some courses may not be activated until the start of the term. If you cannot locate your DL course in Canvas when the term starts, contact the professor.

Professor contact info: Email Professor Bowen at either: mbowen@mtsac.edu, through Student Detail Schedule or Canvas at MyMtSAC Portal.

Students must use their Mt. SAC e-mail account and be aware of course commitment and student expectations described at <http://www.mtsac.edu/instruction/learning/distlearn/>

To prepare for a successful online learning experience, see helpful short videos at <http://www.mtsac.edu/distancelearning/quiz/>

■ **KIN 38 — Physiology of Exercise for Fitness** **3.0 Units**

Degree Applicable

Theory of basic physiological concepts as they pertain to exercise training and the prescription of individual fitness programs.

43136 MW 9:45am - 11:10am Jackson, C 27A-109

■ **KIN 40 — Techniques of Strength Training and Conditioning** **3.0 Units**

Degree Applicable, CSU

(May be taken for option of Letter grade or Pass/NoPass)

Principles and techniques of teaching strength training and cardiovascular exercise.

43197 T 6:30pm - 9:40pm Jones, L 27A-109

■ **KIN 44 — Theory of Coaching** **3.0 Units**

Degree Applicable, CSU, UC

Coaching issues facing the coach today. Designed for coaches at varying levels.

43182 MW 8:00am - 9:25am Purcell, R 45-1462

43153 W 6:20pm - 9:30pm Uiagalelei, I 27A-109

■ **KIN 81 — Work Experience for Coaching** **2.0 Units**

Degree Applicable

Prerequisite: Compliance with Work Experience regulations as designated in College Catalog

Provides coaching and physical education students with on-the-job experience in approved worksites related to coaching.

43139 9.4 hours Bowen, M

NOTE: CRN 43139: requires student to attend orientation on Wednesday, February 14, 2018 in building 27A-109 from 2:00pm to 3:00pm Required Work Experience Packets/Forms will be issued and students will be CONFIRMED for the course at that time. A minimum of 60 unpaid/75 paid of work required hours of work required per credit. For more information regarding the Orientation please contact Arnita Champion, achampion@mtsac.edu or (909) 274- 6080

■ **KIN 85 — Fitness Specialist Internship** **1.0 Unit**

Degree Applicable

(May be taken for option of Letter grade or Pass/NoPass)

On-the-job skill development in fitness testing, analysis and prescription for fitness specialist students.

43137 arrange 4.7 hours Jackson, C 27A-1

NOTE: CRN 43137: requires student to attend orientation on Wednesday, February 14, 2018 in building 27A-109 from 2:00pm to 3:00pm Required Work Experience Packets/Forms will be issued and students will be CONFIRMED for the course at that time. A minimum of 60 unpaid/75 paid of work required hours of work required per credit. For more information regarding the Orientation please contact Arnita Champion, achampion@mtsac.edu or (909) 274- 6080

■ KIN 92 — Work Experience - Athletic Training **2.0 Units**
Degree Applicable

Prerequisite: KIN 19 and compliance with Work Experience regulations as designated in the College Catalog

On-the-job athletic trainer experience. Instructor approval required.
43138 arrange 9.4 hours Landas, M 45-1410

NOTE: CRN 43138: requires student to attend orientation on Wednesday, February 14, 2018 in building 27A-109 from 2:00pm to 3:00pm Required Work Experience Packets/Forms will be issued and students will be CONFIRMED for the course at that time. A minimum of 60 unpaid/75 paid of work required hours of work required per credit. For more information regarding the Orientation please contact Arnita Champion, achampion@mtsac.edu or (909) 274- 6080

LATIN

■ LATN 1 — Elementary Latin **4.0 Units**
Degree Applicable, CSU, UC

(May be taken for option of Letter grade or Pass/NoPass)
Advisory: Eligibility for READ 90 or eligibility for AMLA 33R

Emphasizes the ability to read basic Latin as it was written during the early, classical, and post-classical periods.
42838 TTh 8:30am - 10:35am Edson, T 26D-2240

LEADERSHIP

■ LEAD 55 — Exploring Leadership **3.0 Units**
Degree Applicable, CSU

Explores leadership theories and models and develops a personal philosophy of leadership.
44242 M 11:30am - 2:40pm Calzada, S 12-1080
44243 M 3:00pm - 6:10pm Calzada, S 12-1080

Why wait? Get ahead now.

Earn a free certificate in Leadership

The Leadership Education and Development (LEAD) Program is a FREE non-credit certificate program that shows students how to become effective leaders.

- Attend convenient workshops
- Build your own schedule
- No application required



Learn more at
www.mtsac.edu/studentlife

LEARNING ASSISTANCE

■ LERN 48 — Basic Math Skills Review **3.0 Units**
Not Degree Applicable

(May be taken for Pass/No Pass Only)
Math fundamentals: whole number and decimal operations with an emphasis on math learning strategies.

43592	MW	8:00am - 11:10am	Damansouz, F	6-112
8 Weeks, Week beginning 02/26/2018 ending 04/22/2018				
43597	TTh	8:00am - 9:25am	Robinson, C	6-137
43682	F	8:00am - 11:10am	Watkins, P	6-112
43593	MW	9:45am - 11:10am	Ma, J	6-137
43598	TTh	9:45am - 11:10am	Robinson, C	6-137
43594	MW	1:15pm - 2:40pm	Petrilla, G	6-136
43595	MW	4:45pm - 6:10pm	Torres, J	6-112
43596	M	6:30pm - 9:40pm	Jaramillo, F	6-112
43599	S	8:00am - 11:10am	Hall, J	6-132

■ LERN 49 — Math Skills Review **3.0 Units**
Not Degree Applicable

(May be taken for Pass/No Pass Only)
Prerequisite: LERN 48 or passing score on current placement test
Improves knowledge of basic math. Includes operations and applied problems. Covers math study strategies.

43600	MWF	6:45am - 7:50am	Mason, C	6-134
43601	MW	8:00am - 9:25am	STAFF	6-134
43602	MW	8:00am - 9:25am	Hall, M	6-137
43603	MW	8:00am - 11:10am	Damansouz, F	6-112
8 Weeks, Week beginning 04/23/2018 ending 06/17/2018				
43611	TTh	8:00am - 11:10am	Hall, M	6-112
8 Weeks, Week beginning 02/26/2018 ending 04/22/2018				

NOTE: CRN 43611 above is designed for students in the Bridge Program. Attendance at an information session and special approval are needed to enroll in this learning community. This course is linked to MATH 50 (CRN 42019) and LCOM 90 (CRN 43673). For more information, please contact (909)274-5392.

43612	TTh	8:00am - 9:25am	STAFF	6-134
43616	TTh	8:00am - 11:10am	Hall, M	6-222
8 Weeks, Week beginning 04/23/2018 ending 06/17/2018				
43620	F	8:00am - 11:10am	Ma, J	6-134
43604	MW	9:45am - 11:10am	STAFF	6-134
43613	TTh	9:45am - 11:10am	Walker, L	6-134
43605	MW	11:30am - 12:55pm	Hall, M	6-112
43606	MW	11:30am - 12:55pm	Walker, L	6-134
43664	MW	11:30am - 12:55pm	Ma, J	6-137
43614	TTh	11:30am - 12:55pm	Robinson, C	6-112
43615	TTh	11:30am - 12:55pm	Walker, L	6-134
43607	MW	1:15pm - 2:40pm	Robinson, C	6-112
43665	MW	1:15pm - 2:40pm	Ma, J	6-137
43617	TTh	1:15pm - 2:40pm	Castagnaro, A	6-134
43608	MW	3:00pm - 4:25pm	Robinson, C	6-112
43618	TTh	3:00pm - 4:25pm	Nazzal, J	6-112
43609	MW	4:45pm - 6:10pm	Fallahinezhad, I	6-131
43619	TTh	4:45pm - 6:10pm	Nazzal, J	6-112
43666	MW	6:30pm - 7:55pm	Poulter, C	6-131
43622	M	6:30pm - 9:40pm	Prehn, R	6-134
43623	T	6:30pm - 9:40pm	Pai, R	6-112
43610	W	6:30pm - 9:40pm	STAFF	6-136
43621	S	8:00am - 11:10am	Torres, J	6-112

■ LERN 81 — Improving Writing

3.0 Units
Not Degree Applicable

(May be taken for Pass/No Pass Only)

Develop as a writer through practice and reflection. Improve writing process and product.

43624	MW	8:00am - 9:25am	Ezzell, S	6-130
43625	MW	9:45am - 11:10am	Ezzell, S	6-130
43629	TTh	9:45am - 11:10am	Wheeler, D	6-130
43626	MW	11:30am - 12:55pm	Ezzell, S	6-130
43627	MW	11:30am - 12:55pm	Wheeler, D	6-132
43630	TTh	11:30am - 12:55pm	Wheeler, D	6-130
43628	MW	1:15pm - 2:40pm	Wheeler, D	6-130
43631	TTh	1:15pm - 2:40pm	Stevens, K	6-130
43632	T	6:30pm - 9:40pm	Ramirez, R	6-130
43677	S	8:00am - 11:10am	Emery, M	6-130

LEARNING COMMUNITIES

■ LCOM 90 — Learning Communities: Campus Connections 1.0 Unit
Degree Applicable

Connections between students, the campus, and campus involvement. Concurrent enrollment in a learning community is required.

43673	T	11:30am - 12:35pm	Ma, J	6-136
-------	---	-------------------	-------	-------

NOTE: CRN 43673 above is designed for students in the Bridge Program.

Attendance at an information session and special approval are needed to enroll in this learning community. This course is linked to LERN 49 (CRN 43611) and MATH 50 (CRN 42019). For more information, please contact (909)274-5392.

LIBRARY AND INSTRUCTIONAL MEDIA

■ LIBR 1 — Library Research Methods and Resources 3.0 Units
Degree Applicable, CSU, UC*Advisory: Eligibility for ENGL 68*

Development of academic research plans to answer research questions with selection, synthesis, and ethical use of sources.

44302	M	8:30am - 11:40am	Burton, J	6-238
43669		arrange 3.37 hours	Guo, H	ONLINE

NOTE: No cost digital textbooks or textual materials used.**NOTE:** CRN 43669 is a Distance Learning Online Class.**How to Begin Course:** Log into Canvas through the e-Learning Tools tab in the Mt.SAC portal at inside.mtsac.edu. Then click on the Canvas link and then click on CRN for your DL course. **NOTE:** Some courses may not be activated until the start of the term. If you cannot locate your DL course in Canvas when the term starts, contact the professor. **On the first day of classes, log into your DL course to show your "attendance" because not doing so could result in your being dropped from the class for non-attendance.****Professor contact info:** Email Professor Guo at either: HGuo@mtsac.edu, through Student Detail Schedule or Canvas at MyMtSAC Portal.**Students must use their Mt.SAC e-mail account and be aware of course commitment and student expectations described at <http://www.mtsac.edu/distancelearning/>**To prepare for a successful online learning experience, see helpful short videos at <http://www.mtsac.edu/distancelearning/quiz/>■ LIBR 1A — Introduction to Library Research 1.0 Unit
Degree Applicable, CSU, UC*Advisory: Eligibility for ENGL 68*

Introduction to academic research, finding, evaluating, and citing sources. Recommended for students who have not taken LIBR 1.

44229	Th	10:00am - 11:05am	Woolery, E	6-238
-------	----	-------------------	------------	-------

NOTE: No cost digital textbooks or textual materials used.

43683	T	12:00pm - 2:05pm	Rios-Alvarado, E	6-238
-------	---	------------------	------------------	-------

8 Weeks, Week beginning 04/23/2018 ending 06/17/2018**NOTE: No cost digital textbooks or textual materials used.**

43670		arrange 2.25 hours	Swartz, P	ONLINE
-------	--	--------------------	-----------	--------

8 Weeks, Week beginning 04/23/2018 ending 06/17/2018**NOTE: No cost digital textbooks or textual materials used.****NOTE:** CRN 43670 is a Distance Learning Online Class.**How to Begin Course:** Log into Canvas through the e-Learning Tools tab in the Mt.SAC portal at inside.mtsac.edu. Then click on the Canvas link and then click on CRN for your DL course. **NOTE:** Some courses may not be activated until the start of the term. If you cannot locate your DL course in Canvas when the term starts, contact the professor. **On the first day of classes, log into your DL course to show your "attendance" because not doing so could result in your being dropped from the class for non-attendance.****Professor contact info:** Email Professor Swartz at either: PSwartz@mtsac.edu, through Student Detail Schedule or Canvas at MyMtSAC Portal.**Students must use their Mt.SAC e-mail account and be aware of course commitment and student expectations described at <http://www.mtsac.edu/distancelearning/>**To prepare for a successful online learning experience, see helpful short videos at <http://www.mtsac.edu/distancelearning/quiz/>

44230		arrange 1.13 hours	Vansistine-Yost, L	ONLINE
-------	--	--------------------	--------------------	--------

NOTE: No cost digital textbooks or textual materials used.**NOTE:** CRN 44230 is a Distance Learning Online Class.**How to Begin Course:** Log into Canvas through the e-Learning Tools tab in the Mt.SAC portal at inside.mtsac.edu. Then click on the Canvas link and then click on CRN for your DL course. **NOTE:** Some courses may not be activated until the start of the term. If you cannot locate your DL course in Canvas when the term starts, contact the professor. **On the first day of classes, log into your DL course to show your "attendance" because not doing so could result in your being dropped from the class for non-attendance.****Professor contact info:** Email Professor VanSistine-Yost at either: LVansistineyost@mtsac.edu, through Student Detail Schedule or Canvas at MyMtSAC Portal.**Students must use their Mt.SAC e-mail account and be aware of course commitment and student expectations described at <http://www.mtsac.edu/distancelearning/>**To prepare for a successful online learning experience, see helpful short videos at <http://www.mtsac.edu/distancelearning/quiz/>

MANUFACTURING TECHNOLOGY

■ MFG 110 — Introduction to CAD 4.0 Units
Not Degree Applicable, CSU*Advisory: Eligibility for MATH 51*

Basic Computer Aided Design (CAD) and computer applications. Production card and digital calipers required.

43949	MW	3:00pm - 4:30pm	Cusolito, A	28B-301B
	and MW	4:35pm - 6:10pm	Cusolito, A	28B-301B

NOTE: Pre-requisites may be waived based upon qualifications and experience. For more information, please contact Stephen James at sjames@mtsac.edu

43951	TTh	7:00pm - 8:30pm	Cusolito, A	28B-301A
	and TTh	8:40pm - 10:10pm	Cusolito, A	28B-301A

NOTE: Pre-requisites may be waived based upon qualifications and experience. For more information, please contact Stephen James at sjames@mtsac.edu

■ **MFG 120 — CAD for Manufacturing** **4.0 Units**
Degree Applicable, CSU

Prerequisite: MFG 110 or CSWA Certification

Intermediate CAD for engineering, 3D parametric solid modeling, assemblies and drafting. Production card; calipers required.

43953 MW 3:00pm - 3:50pm Takahashi, S 28B-301A
and MW 4:00pm - 6:10pm Takahashi, S 28B-301A

NOTE: Pre-requisites may be waived based upon qualifications and experience. For more information, please contact Stephen James at sjames@mtsac.edu

■ **MFG 130 — Manufacturing Processes and Materials** **3.0 Units**
Degree Applicable, CSU

Manufacturing process, rapid prototyping technologies, non-machining process, metal and plastic bending, forming, molding, casting.

43956 MW 7:00pm - 8:10pm Cusolito, A 28B-305
and MW 8:20pm - 9:45pm Cusolito, A 28B-305

NOTE: Pre-requisites may be waived based upon qualifications and experience.

For more information, please contact Stephen James at sjames@mtsac.edu

■ **MFG 150 — Manual Machining I** **3.0 Units**
Degree Applicable, CSU

Prerequisite: MFG 140

Conventional machining processes with application to CNC machines. Production cards and calipers required.

43959 TTh 3:15pm - 4:20pm Bright, T 28A-102K
and TTh 4:30pm - 5:50pm Bright, T 28A-102K

NOTE: Pre-requisites may be waived based upon qualifications and experience. For more information, please contact Stephen James at sjames@mtsac.edu

■ **MFG 155 — Manual Machining II** **2.0 Units**
Degree Applicable, CSU

Prerequisite: MFG 150

Intermediate application of conventional mill and lathe.

43964 F 6:00pm - 6:50pm Bright, T 28A-102K
and F 7:00pm - 10:15pm Bright, T 28A-102K

NOTE: Pre-requisites may be waived based upon qualifications and experience. For more information, please contact Stephen James at sjames@mtsac.edu

■ **MFG 160 — Introduction to Mechanical Principles** **3.0 Units**
Degree Applicable

Prerequisite: EDT 16 or MFG 110

Mechanical devices, concepts, and principles. Production cards, calipers required. May require field trips.

43966 TTh 7:00pm - 8:05pm Richins, G 28B-310
and TTh 8:15pm - 9:40pm Richins, G 28B-310

NOTE: Pre-requisites may be waived based upon qualifications and experience. For more information, please contact Stephen James at sjames@mtsac.edu

■ **MFG 180 — Introduction to MasterCAM** **3.0 Units**
Degree Applicable, CSU

Prerequisite: MFG 155

Use MasterCAM X software to create wire-frame part geometry, add tool paths, and create CNC code for CNC mills and CNC lathes.

43968 TTh 7:00pm - 8:05pm Buechler, M 28B-301A
and TTh 8:15pm - 9:40pm Buechler, M 28B-301A

NOTE: Pre-requisites may be waived based upon qualifications and experience. For more information, please contact Stephen James at sjames@mtsac.edu

■ **MFG 210 — Advanced CAD** **3.0 Units**
Degree Applicable, CSU

Prerequisite: MFG 120 or CSWA Certification

Advanced CAD to develop detailed working drawings using 3D solid modeling. Production card, calipers and field trip required.

43958 MW 7:00pm - 8:30pm Galaz, J 28B-301A
and MW 8:40pm - 10:10pm Galaz, J 28B-301A

NOTE: Pre-requisites may be waived based upon qualifications and experience. For more information, please contact Stephen James at sjames@mtsac.edu

■ **MFG 250 — Introduction to CNC Programming** **3.0 Units**
Not Degree Applicable

Prerequisite: MFG 150

Theory and practice of writing program code for CNC mills and lathes.

43969 TTh 6:00pm - 9:10pm STAFF 28A-102K
and T 9:20pm - 10:10pm STAFF 28A-102K

NOTE: Pre-requisites may be waived based upon qualifications and experience. For more information, please contact Stephen James at sjames@mtsac.edu

■ **MFG 260 — Intermediate CNC** **3.0 Units**
Degree Applicable

Prerequisite: MFG 250

Operation of computer numerical control (CNC) machines and their applications in manufacturing.

43970 MW 6:00pm - 9:10pm STAFF 28A-102K
and M 9:20pm - 10:10pm STAFF 28A-102K

NOTE: Pre-requisites may be waived based upon qualifications and experience. For more information, please contact Stephen James at sjames@mtsac.edu

MATHEMATICS

■ **MATH 50 — Pre-Algebra** **3.0 Units**
Not Degree Applicable

Prerequisite: LERN 49 or qualifying score on current department placement test

Fundamental principles of mathematics designed to ease the transition from arithmetic to algebra.

42017 MTWTh 8:00am - 9:25am Wakefield, J 61-3306
8 Weeks, Week beginning 02/26/2018 ending 04/22/2018

42018 MTWTh 8:00am - 9:25am Wakefield, J 61-3306
8 Weeks, Week beginning 04/23/2018 ending 06/17/2018

42021 MW 8:00am - 9:25am STAFF 61-3411

42026 T 8:00am - 11:10am Chavez, D 61-2414
and arrange 3.4 hours Chavez, D ONLINE

8 Weeks, Week beginning 02/26/2018 ending 04/22/2018

NOTE: CRN 42026 is an 8-week Hybrid Class taught partially online with Schedule Meetings on Campus.

How to Begin Course: Log into Moodle rooms through the eLearning Tools tab in the Mt. SAC portal at my.mtsac.edu. Click on the Moodle rooms link and then click on the CRN for your DL course. **NOTE:** Some courses may not be activated until the start of the term. If you cannot locate your DL course in Moodle rooms when the term starts, contact the professor.

Professor contact info: Email Professor Chavez at either: dchavez@mtsac.edu, through Student Detail Schedule or Moodle rooms at MyMtSAC Portal.

Students must use their Mt. SAC e-mail account and be aware of course commitments and student expectations described at <http://www.mtsac.edu/instruction/learning/distlearn/>

42019 TTh 8:00am - 11:10am Ma, J 61-112
8 Weeks, Week beginning 04/23/2018 ending 06/17/2018

NOTE: CRN 42019 above is designed for students in the Bridge Program. Attendance at an information session and special approval are needed to enroll in this learning community. This course is linked to LERN 49 (CRN 43611) and LCOM 90 (CRN 43673). For more information, please contact (909)274-5392.

42022 TTh 8:00am - 9:25am Summers, M 61-2406

MATHEMATICS COURSE SEQUENCES

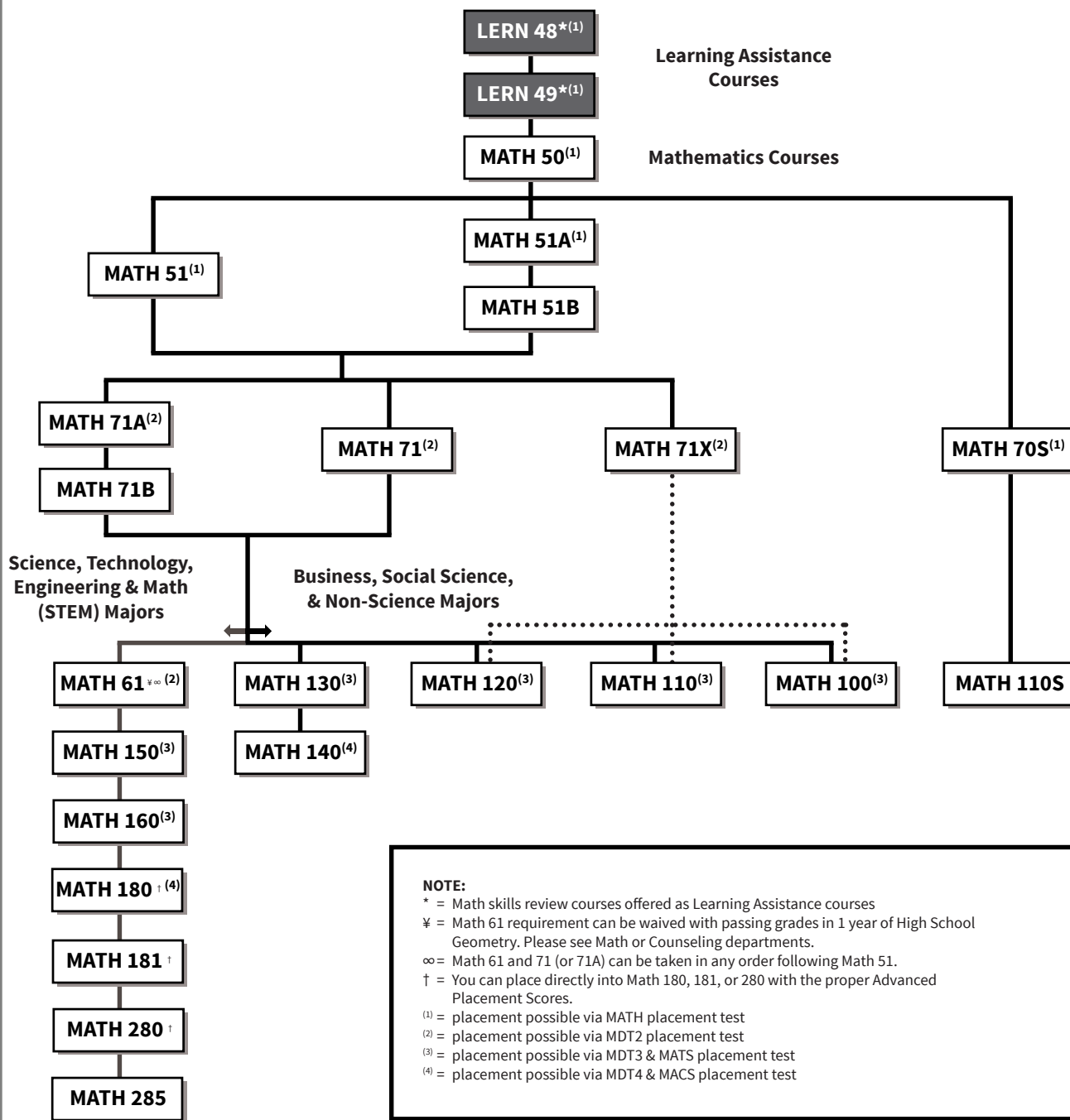

42023	TTh	8:00am - 9:25am	Wono, K	61-3410
42025	TTh	8:00am - 9:25am	Lee, P	61-3315
42020	WF	8:00am - 9:25am	Lee, P	61-2419
42027	Th	8:00am - 11:10am	Chavez, D	61-2414
		and arrange 3.4 hours	Chavez, D	ONLINE

8 Weeks, Week beginning 02/26/2018 ending 04/22/2018

NOTE: CRN 42027 is an 8-week Hybrid Class taught partially online with Schedule Meetings on Campus.

How to Begin Course: Log into Moodle rooms through the eLearning Tools tab in the Mt. SAC portal at my.mtsac.edu. Click on the Moodle rooms link and then click on the CRN for your DL course. **NOTE:** Some courses may not be activated until the start of the term. If you cannot locate your DL course in Moodle rooms when the term starts, contact the professor.

Professor contact info: Email Professor Chavez at either: dchavez@mtsac.edu, through Student Detail Schedule or Moodle rooms at MyMtSAC Portal.

Students must use their Mt. SAC e-mail account and be aware of course commitments and student expectations described at <http://www.mtsac.edu/instruction/learning/distlearn/>

42024	F	8:30am - 11:40am	Loyd, R	61-2410
42266	F	8:30am - 11:40am	Ramirez, C	61-3414
42028	MW	9:45am - 11:10am	Peng, G	61-2419
42029	TTh	9:45am - 11:10am	Ong, H	61-3302
42030	TTh	9:45am - 11:10am	STAFF	61-3419
42031	TTh	9:45am - 11:10am	Wono, K	61-3418
43481	TTh	11:30am - 12:55pm	Ong, H	11-2115
42032	TWTh	12:00pm - 2:05pm	Peng, G	61-3310

8 Weeks, Week beginning 02/26/2018 ending 04/22/2018

NOTE: CRN 42032 above is designed for students in the Bridge Program. Attendance at an information session and special approval are needed to enroll in this learning community. This course is linked to MATH 51 (CRN 42052) and COUN 2 (CRN 44291). For more information, please contact (909)274-5392.

42035	TTh	1:15pm - 2:40pm	Wono, K	61-2418
42034	MW	1:45pm - 3:10pm	STAFF	61-3411
42036	TTh	1:45pm - 3:10pm	Terreri, J	61-3411
42190	MW	3:00pm - 4:25pm	STAFF	61-3310
42037	M	3:00pm - 6:10pm	Khoddam, K	61-2319
42208	W	3:00pm - 6:10pm	Khoddam, K	61-2319
43482	MW	3:30pm - 4:55pm	Harirchi, M	11-2115
42192	TTh	3:30pm - 4:55pm	Terreri, J	61-3411
42193	TTh	3:30pm - 4:55pm	White, R	61-3310
42221	MW	4:45pm - 6:10pm	Rahman, M	61-3414
42227	MW	4:45pm - 6:10pm	Lam, H	61-3310
42235	TTh	4:45pm - 6:10pm	Arellano, M	61-3414
42231	MW	5:15pm - 6:40pm	Harirchi, M	61-2414
42241	TTh	5:15pm - 6:40pm	Garland, J	61-3310
42252	MW	6:30pm - 7:55pm	STAFF	61-3310
42253	MW	7:00pm - 8:25pm	STAFF	61-2414
42261	TWTh	7:00pm - 9:05pm	Hernandez-Saul, C	61-3306

8 Weeks, Week beginning 02/26/2018 ending 04/22/2018

NOTE: CRN 42261 is linked to CRN 42251 and is a part of the Pathways Program. This course is continuing from the Winter term and seats are reserved for students already in the program. Any additional seats will be open for registration to any eligible student. This course is a part of Math Cohort #10. If you have any questions please email pathways@mtsac.edu or call (909) 274-5703.

42256	TTh	7:00pm - 8:25pm	Jacobo, J	61-3310
42259	TTh	7:00pm - 8:25pm	White, R	61-2319

■ MATH 51 — Elementary Algebra **4.0 Units**
Not Degree Applicable

Prerequisite: MATH 50 or qualifying score on current department placement test

An introductory course in algebra.

42038	MTWTh	7:30am - 9:35am	STAFF	61-3406
-------	-------	-----------------	-------	---------

8 Weeks, Week beginning 02/26/2018 ending 04/22/2018

NOTE: CRN 42038 is linked to CRN 42070 and is a part of the Pathways Program. This course is continuing from the Winter term and seats are reserved for students already in the program. Any additional seats will be open for registration to any eligible student. This course is a part of Math Cohort #12. If you have any questions please email pathways@mtsac.edu or call (909) 274-5703.

42039	MW	7:30am - 9:35am	Chan, L	61-2410
42040	MW	7:30am - 9:35am	STAFF	61-2414
42041	TTh	7:30am - 9:35am	Huang, L	61-2319
42042	TTh	7:30am - 9:35am	STAFF	61-2410
42043	MW	8:30am - 10:35am	Eleuteri, R	61-2316
42044	TTh	8:30am - 10:35am	Troxell, C	61-3415
42045	F	9:00am - 1:15pm	Sun, C	61-3418
42046	MTWTh	9:45am - 11:50am	Wakefield, J	61-3306

8 Weeks, Week beginning 02/26/2018 ending 04/22/2018

NOTE: CRN 42046 is linked to CRN 42076 and is a part of the Pathways Program. This course is continuing from the Winter term and seats are reserved for students already in the program. Any additional seats will be open for registration to any eligible student. This course is a part of Math Cohort #9. If you have any questions please email pathways@mtsac.edu or call (909) 274-5703.

42047	MTWTh	9:45am - 11:50am	Munro, M	61-2306
-------	-------	------------------	----------	---------

8 Weeks, Week beginning 02/26/2018 ending 04/22/2018

NOTE: CRN 42047 above is designed for students in the Bridge Program. Attendance at an information session and special approval are needed to enroll in this learning community. This course is linked to MATH 71 (CRN 42075) and COUN 5 (CRN 44411). For more information, please contact (909)274-5392.

42048	MWF	10:00am - 11:15am	Perez, C	61-3302
42050	MW	10:45am - 12:50pm	STAFF	61-2316
42049	TTh	10:45am - 12:50pm	Young, P	61-2311
42051	TThF	11:30am - 12:45pm	Lai, I	61-3302
42052	MTWTh	12:00pm - 2:05pm	Peng, G	61-3310

8 Weeks, Week beginning 04/23/2018 ending 06/17/2018

NOTE: CRN 42052 above is designed for students in the Bridge Program. Attendance at an information session and special approval are needed to enroll in this learning community. This course is linked to MATH 50 (CRN 42032) and COUN 2 (CRN 44291). For more information, please contact (909)274-5392.

42053	MTWTh	12:00pm - 2:05pm	Case, M	61-2414
-------	-------	------------------	---------	---------

8 Weeks, Week beginning 02/26/2018 ending 04/22/2018

NOTE: CRN 42053 is linked to CRN 42088 and is a part of the Pathways Program. This course is continuing from the Winter term and seats are reserved for students already in the program. Any additional seats will be open for registration to any eligible student. This course is a part of Math Cohort #8. If you have any questions please email pathways@mtsac.edu or call (909) 274-5703.

42054	MW	12:00pm - 2:05pm	Arellano, M	61-3302
42055	TTh	12:00pm - 2:05pm	Wohlgezogen, L	61-2302
42056	MW	1:00pm - 3:05pm	Kirchgraber, A	61-2311
42057	TTh	1:00pm - 3:05pm	Johnson, K	61-3315
42058	TThF	1:00pm - 2:15pm	Lai, I	61-3302
42059	MW	2:15pm - 4:20pm	Edwards, W	61-2310
42060	MW	2:15pm - 4:20pm	Arellano, M	61-3302
42061	MW	2:15pm - 4:20pm	Lam, H	61-3406
42062	TTh	2:15pm - 4:20pm	Garland, J	61-2302
42063	MW	3:15pm - 5:20pm	Tamayo, J	61-3419
42064	TTh	3:15pm - 5:20pm	Yao, J	61-3315
42065	MW	4:30pm - 6:35pm	Edwards, W	61-2310
42066	MW	4:30pm - 6:35pm	Morales, L	61-2410
42188	MW	4:30pm - 6:35pm	Saravia, W	61-3406
43483	TTh	4:30pm - 6:35pm	Ly, H	11-2115
42222	MW	5:30pm - 7:35pm	Nguyen, C	61-2316
42236	TTh	5:30pm - 7:35pm	Byun, E	61-3315
42243	MW	6:45pm - 8:50pm	STAFF	61-3406
43484	TTh	6:45pm - 8:50pm	Kim, M	11-2115
42251	TWTh	7:00pm - 9:50pm	Hernandez-Saul, C	61-3306

8 Weeks, Week beginning 04/23/2018 ending 06/17/2018

NOTE: CRN 42251 is linked to CRN 42261 and is a part of the Pathways Program. This course is continuing from the Winter term and seats are reserved for students already in the program. Any additional seats will be open for registration to any eligible student. This course is a part of Math Cohort #10. If you have any questions please email pathways@mtsac.edu or call (909) 274-5703.

42257	MW	7:45pm - 9:50pm	Harirchi, M	61-2316
42260	TTh	7:45pm - 9:50pm	Byun, E	61-3315

MATH 51A — Elementary Algebra - First Half **3.0 Units**

Not Degree Applicable

Prerequisite: MATH 50 or qualifying score on current department placement test

Covers some MATH 51 topics at a slower pace. Student must complete MATH 51A and MATH 51B to have taken the equivalent of MATH 51.

42067	MW	8:30am - 9:55am	Ramirez, C	61-3418
42186	TTh	9:45am - 11:10am	Johnson, M	61-2315
42187	TTh	7:00pm - 8:25pm	Yao, J	61-3415

MATH 51B — Elementary Algebra - Second Half **3.0 Units**

Not Degree Applicable

Prerequisite: MATH 51A

Covers remaining topics of MATH 51 at a slower pace. Students must complete MATH 51A and B to have taken the equivalent of MATH 51.

42068	TTh	9:45am - 11:10am	Kim, W	61-3406
42239	MW	6:30pm - 7:55pm	Rahman, M	61-3419

MATH 61 — Plane Geometry **3.0 Units**

Degree Applicable

Prerequisite: MATH 51 or MATH 51B or qualifying score on current department placement test

Points, lines, polygons and circles; their relationships to each other on plane surfaces; congruence, similarity and area.

42183	TTh	9:45am - 11:10am	Summers, M	61-2406
42182	MW	1:15pm - 2:40pm	Pachas, E	61-3414
42280	TTh	7:00pm - 8:25pm	Garland, J	61-2410

MATH 70S — Integrated Intermediate Algebra **5.0 Units**

Degree Applicable

Prerequisite: MATH 50 or qualifying score on current department placement test.

Math 70S is an intermediate algebra course that integrates topics from statistics, and is the prerequisite to Math 110S.

42224	TTh	1:30pm - 4:05pm	Lancaster, S	61-2419
42223	MW	3:15pm - 5:50pm	Guth, S	61-2306
42225	TTh	4:15pm - 6:50pm	Lancaster, S	61-2419
42238	TTh	7:00pm - 9:35pm	Lai, I	61-3419

MATH 71 — Intermediate Algebra **5.0 Units**

Degree Applicable

Prerequisite: MATH 51 or MATH 51B or qualifying score on current department placement test

Extends concepts from elementary algebra to prepare students for college-level mathematics courses.

42069	MTWTh	7:00am - 9:35am	Kirchgraber, A	61-2302
-------	-------	-----------------	----------------	---------

8 Weeks, Week beginning 02/26/2018 ending 04/22/2018

NOTE: CRN 42069 is linked to CRN 42112 and is a part of the Pathways Program. This course is continuing from the Winter term and seats are reserved for students already in the program. Any additional seats will be open for registration to any eligible student. This course is a part of Math Cohort #11. If you have any questions please email pathways@mtsac.edu or call (909) 274-5703.

42070	MTWTh	7:00am - 9:35am	STAFF	61-3406
-------	-------	-----------------	-------	---------

8 Weeks, Week beginning 04/23/2018 ending 06/17/2018

NOTE: CRN 42070 is linked to CRN 42038 and is a part of the Pathways Program. This course is continuing from the Winter term and seats are reserved for students already in the program. Any additional seats will be open for registration to any eligible student. This course is a part of Math Cohort #12. If you have any questions please email pathways@mtsac.edu or call (909) 274-5703.

42071	MW	7:00am - 9:35am	Rivers, D	61-3414
42072	TTh	7:00am - 9:35am	Wong, J	61-2315
42074	MW	8:00am - 10:35am	Wong, J	61-2319
42073	MWF	8:00am - 9:35am	Zicree, S	61-3415
42075	MTWTh	9:45am - 12:20pm	Munro, M	61-2306

8 Weeks, Week beginning 04/23/2018 ending 06/17/2018

NOTE: CRN 42075 above is designed for students in the Bridge Program. Attendance at an information session and special approval are needed to enroll in this learning community. This course is linked to MATH 51 (CRN 42047) and COUN 5 (CRN 44411). For more information, please contact (909)274-5392.

42076	MTWTh	9:45am - 12:20pm	Wakefield, J	61-3306
-------	-------	------------------	--------------	---------

8 Weeks, Week beginning 04/23/2018 ending 06/17/2018

NOTE: CRN 42076 is linked to CRN 42046 and is a part of the Pathways Program. This course is continuing from the Winter term and seats are reserved for students already in the program. Any additional seats will be open for registration to any eligible student. This course is a part of Math Cohort #9. If you have any questions please email pathways@mtsac.edu or call (909) 274-5703.

42077	MW	9:45am - 12:20pm	Rivers, D	61-3414
42079	TWThF	9:45am - 12:20pm	Takashima, T	61-2310

8 Weeks, Week beginning 02/26/2018 ending 04/22/2018

42080	TWThF	9:45am - 12:20pm	Takashima, T	61-2310
-------	-------	------------------	--------------	---------

8 Weeks, Week beginning 04/23/2018 ending 06/17/2018

42081	TTh	9:45am - 12:20pm	Loyd, R	61-2410
-------	-----	------------------	---------	---------

NOTE: CRN 42081 above is designed for students in the Bridge Program. Attendance at an information session and special approval are needed to enroll in this learning community. This course is linked to COUN 5 (CRN 44363). For more information, please contact (909)274-5392.

42082	TTh	9:45am - 12:20pm	Lee, P	61-3315
42078	WF	9:45am - 12:20pm	Lee, P	61-3419
42083	MTWTh	10:00am - 11:15am	Kirchgraber, A	61-2302
43532	MW	10:45am - 1:15pm	Eleuteri, R	TBA
42084	MWF	11:00am - 12:35pm	Khoddam, K	61-2319
42085	MWF	11:30am - 1:05pm	Birca, A	61-2302
42086	MWF	11:30am - 1:05pm	Zicree, S	61-3415
42087	TThF	11:30am - 1:05pm	Terrerri, J	61-3411
42088	MTWTh	12:30pm - 3:05pm	Case, M	61-2414

8 Weeks, Week beginning 04/23/2018 ending 06/17/2018

NOTE: CRN 42088 is linked to CRN 42053 and is a part of the Pathways Program. This course is continuing from the Winter term and seats are reserved for students already in the program. Any additional seats will be open for registration to any eligible student. This course is a part of Math Cohort #8. If you have any questions please email pathways@mtsac.edu or call (909) 274-5703.

42089	MW	12:30pm - 3:05pm	Mc Mullin, J	61-3410
42090	MW	12:30pm - 3:05pm	STAFF	61-3306
42091	TTh	12:30pm - 3:05pm	Nguyen, H	61-3306
44774	TTh	12:30pm - 3:05pm	Aguilar, J	61-3414
42092	MWF	12:45pm - 2:20pm	Khoddam, K	61-2319
42093	TThF	12:45pm - 2:20pm	Loyd, R	61-2410
42094	MW	1:30pm - 4:05pm	Birca, A	61-2302
42096	MW	1:30pm - 4:05pm	Johnson, K	61-2316
42095	TTh	1:30pm - 4:05pm	Edwards, W	61-2306
42097	TTh	1:30pm - 4:05pm	Ly, H	61-2315
42098	MW	3:15pm - 5:50pm	Kassab, M	61-3315
42099	MW	3:15pm - 5:50pm	STAFF	61-2311
42100	MW	3:15pm - 5:50pm	Butenko, A	61-2406
42101	TTh	3:15pm - 5:50pm	Kim, M	61-3415
42102	TTh	3:15pm - 5:50pm	Bortis, D	61-2311
42195	TTh	3:15pm - 5:50pm	Wong, R	61-3302
42196	MW	4:15pm - 6:50pm	Lam, A	61-2315
42204	MW	4:15pm - 6:50pm	Leung, S	61-2419
42214	MW	4:15pm - 6:50pm	Sun, C	61-3418
42219	TTh	4:15pm - 6:50pm	Lee, C	61-2315
42281	TTh	4:15pm - 6:50pm	Aguilar, J	61-2406
42230	MW	6:00pm - 8:35pm	Hattar, M	61-2311
42237	MW	6:00pm - 8:35pm	Chang, H	61-2406
42244	TTh	6:00pm - 8:35pm	Chang, H	61-2311
42245	TTh	6:00pm - 8:35pm	Wong, R	61-3302
42248	MW	7:00pm - 9:35pm	Sun, C	61-3418
42249	MW	7:00pm - 9:35pm	Lam, A	61-2315
42255	MW	7:00pm - 9:35pm	Leung, S	61-2419
43536	MW	7:00pm - 9:35pm	Abbott, J	TBA
42258	TTh	7:00pm - 9:35pm	Lee, C	61-2315
42282	TTh	7:00pm - 9:35pm	Chau, E	61-2406

MATH



The Math Bridge provides a combination of Math and Counseling courses for students seeking a unique learning experience. In addition, students will learn what it takes to succeed in college and beyond. Students will work in teams, and receive tutoring in these courses. (Tutoring upon availability and by instructor request). Please contact the Bridge Program at (909)274-5392 or come in person to the Student Success Center, Bldg. 9E (2nd Floor) to **reserve your space for attendance** at any one of our Information Sessions. **Space is limited!**

If you would like to find out more information and/or you are interested in enrolling in the Bridge Program, visit us at the Student Services Annex, Bldg. 9D or online at www.mtsac.edu/students/bridge/.

MATH BRIDGE SPRING 2018 COURSES

CLUSTER 1

Link 1

LERN 49*

43611 TTh 8:00 am - 11:10 am Hall, M. 3 units 6-112

*First 8 weeks, beginning February 26, 2018 and ending on April 22, 2018

MATH 50*

42019 TTh 8:00 am - 11:10 am Ma, J. 3 units 61-3419

*Second 8 weeks, beginning April 23, 2018, and ending on June 17, 2018

LCOM 90

43673 T 11:30 am-12:35 pm Ma, J. & Hall, M. 1 unit 6-136

NOTE: Attendance at an information session and special approval is needed to enroll in this learning community.

CLUSTER 2

Link 1

MATH 50*

42032 TWTh 12:00 pm - 2:05 pm Peng, G. 3 units 61-3310

*First 8 weeks, beginning February 26, 2018 and ending on April 22, 2018

MATH 51*

42052 MTWTh 12:00 pm - 2:05 pm Peng, G. 4 units 61-3310

*Second 8 weeks, beginning April 23, 2018, and ending on June 17, 2018

COUN 2

44291 TTh 9:45 am - 11:10 am Hart, J. 3 units 12-1060

NOTE: Attendance at an information session and special approval is needed to enroll in this learning community.

CLUSTER 3

Link 1

MATH 51*

42047 MTWTh 9:45 am - 11:50 am Munro, M. 4 units 61-2306

*First 8 weeks, beginning February 26, 2018 and ending on April 22, 2018

MATH 71*

42075 MTWTh 9:45 am - 12:20 pm Munro, M. 5 units 61-2306

*Second 8 weeks, beginning April 23, 2018, and ending on June 17, 2018

COUN 5*

44411 MW 8:00 am - 9:25 am Torres, A. 3 units 211-1

*Prerequisite: Eligibility for Engl 68

NOTE: Attendance at an information session and special approval is needed to enroll in this learning community.

CLUSTER 4

Link 1

MATH 71

42081 TTh 9:45 am - 12:20 pm Loyd, R. 5 units 61-2410

COUN 5*

44363 TTh 1:15 pm - 2:40 pm Trejo, L. 3 units TBA

*Prerequisite: Eligibility for Engl 68

NOTE: Attendance at an information session and special approval is needed to enroll in this learning community.

CLUSTER 5

Link 1

MATH 130

42129 TTh 7:30 am - 9:35 am Munro, M. 4 units 61-2306

COUN 7

44406 TTh 10:00 am - 11:05 am Barrios, M. 2 units 21A-1

NOTE: Attendance at an information session and special approval is needed to enroll in this learning community.

MATH BRIDGE INFORMATION SESSIONS

Visit us at <http://www.mtsac.edu/bridge/communities.html> for an updated schedule of Bridge Information Sessions.

Interested in attending a Bridge Information Session?

To attend an Information Session, please follow these steps:

1. A Mt. SAC student **MUST attend one** of the Math Bridge Information Sessions to be considered for enrollment into any of the Bridge Program learning communities. This session is an opportunity for students to find out about the Bridge Program and whether our learning communities will be a good fit academically for you.
2. Please contact us at (909) 274-5392 or visit us at the Student Services Annex, Bldg. 9D to **reserve your space** at one of our Information Sessions. **Space is limited!**
3. Please be prepared and have knowledge of your Mt. SAC student I.D. number and what courses you are eligible for.
4. Limited seating is available in every session. Attendance at an Information Session **does not guarantee enrollment** into the Bridge Program classes. Availability of spaces in the Bridge Program learning communities are subject to change and are based on several factors such as, but not limited to: student's placement test results, open spaces in our classes, and/or courses already taken either at Mt. SAC or another college.

MATH 71A — Intermediate Algebra - First Half **3.0 Units**

Not Degree Applicable

Prerequisite: MATH 51 or MATH 51B or qualifying score on current department placement test

Covers approximately half of MATH 71 topics. Student must complete both MATH 71A and 71B to have taken the equivalent of MATH 71.

42103	MW	8:00am - 9:25am	Wohlgezogen, L	61-3410
42104	TTh	11:30am - 12:55pm	Johnson, M	61-2315
42189	MW	8:15pm - 9:40pm	Rahman, M	61-3415

MATH 71B — Intermediate Algebra - Second Half **3.0 Units**

Degree Applicable

Prerequisite: MATH 71A

Covers remaining MATH 71 topics at a slower pace. Student must complete MATH 71A and 71B to have taken the equivalent of MATH 71.

42105	TTh	9:45am - 11:10am	Rivas, K	61-2319
42106	MW	12:00pm - 1:25pm	Ali, S	61-3411
42107	MW	7:00pm - 8:25pm	Saravia, W	61-2319

MATH 71X — Practical Intermediate Algebra **5.0 Units**

Degree Applicable

Prerequisite: MATH 51 or MATH 51B or qualifying score on current department placement test.

Intermediate Algebra for the non-calculus path.

42108	MW	8:00am - 10:35am	Summers, M	61-2406
42109	TTh	12:30pm - 3:05pm	Summers, M	61-2406

MATH 96 — Strategies for Math Success **1.0 Unit**

Not Degree Applicable

(May be taken for Pass/No Pass Only)

Perspectives and strategies to utilize a learning system to acquire, understand, and remember mathematical knowledge.

42220	TTh	7:00pm - 8:50pm	Long, G	61-2414
5 Weeks, Week beginning 02/26/2018 ending 04/01/2018				
42283	TTh	7:00pm - 8:50pm	Long, G	61-2414
5 Weeks, Week beginning 04/02/2018 ending 05/06/2018				
42284	TTh	7:00pm - 8:50pm	Long, G	61-2414
5 Weeks, Week beginning 05/07/2018 ending 06/10/2018				

MATH 110 — Elementary Statistics **3.0 Units**

Degree Applicable, CSU, UC

Prerequisite: MATH 71 or MATH 71X or MATH 71B or qualifying score on current department placement test

Descriptive and inferential statistics and probability with emphasis on statistical methods.

42112	MTWTh	8:00am - 9:25am	Kirchgraber, A	61-2302
8 Weeks, Week beginning 04/23/2018 ending 06/17/2018				

NOTE: CRN 42112 is linked to CRN 42069 and is a part of the Pathways Program. This course is continuing from the Winter term and seats are reserved for students already in the program. Any additional seats will be open for registration to any eligible student. This course is a part of Math Cohort #11. If you have any questions please email pathways@mtsac.edu or call (909) 274-5703.

42110	MW	8:00am - 9:25am	Rolle, B	61-3310
42111	MW	8:00am - 9:25am	Menjivar, J	61-2418
42117	MW	8:00am - 9:25am	Humaciu, M	61-2311
42113	TTh	8:00am - 9:25am	Humaciu, M	61-3310

NOTE: CRN 42113 is a part of the Pathways Program and is continuing from the Winter term. Seats are reserved for students already in the program. Any additional seats will be open for registration to any eligible student. This course is a part of Math Cohort #1. If you have any questions please email pathways@mtsac.edu or call (909) 274-5703.

42114	TTh	8:00am - 9:25am	Rolle, B	61-2418
42115	TTh	8:00am - 9:25am	STAFF	61-3302
42118	TTh	8:00am - 9:25am	Garcia, R	61-3411
43567	TTh	8:00am - 9:25am	Kim, W	TBA
42116	F	8:00am - 11:10am	Kirchgraber, A	61-2302
42119	MW	9:45am - 11:10am	Menjivar, J	61-3411
42120	TTh	9:45am - 11:10am	Kim, C	61-2418
42121	TTh	9:45am - 11:10am	Huang, L	61-3310
43568	TTh	9:45am - 11:10am	Humaciu, M	TBA
42122	TTh	11:30am - 12:55pm	Kim, C	61-2418
42285	F	11:30am - 2:40pm	Faradineh, R	61-3410
42123	TTh	12:00pm - 1:25pm	Troxell, C	61-3418
42124	MW	1:15pm - 2:40pm	Nguyen, C	61-3415
42125	TTh	1:15pm - 2:40pm	Takashima, T	61-2310
43570	TTh	1:15pm - 2:40pm	Garcia, R	TBA
42126	TTh	1:45pm - 3:10pm	Huang, L	61-3319
42184	MW	3:00pm - 4:25pm	Nguyen, C	61-3415
42197	T	3:00pm - 6:10pm	Johnson, M	61-2410
42268	Th	3:00pm - 6:10pm	Hernandez-Saul, C	61-2410
42185	MW	3:30pm - 4:55pm	Case, M	61-2414
42198	TTh	3:30pm - 4:55pm	Case, M	61-2414
42205	TTh	3:30pm - 4:55pm	Panchal, M	61-3319
42210	MW	4:45pm - 6:10pm	Faradineh, R	61-3415
42215	TTh	4:45pm - 6:10pm	Alvarado, N	61-3410
42216	MW	5:15pm - 6:40pm	Kojima, T	61-3319
42232	MW	5:15pm - 6:40pm	Alvarado, N	61-3410
42233	TTh	5:15pm - 6:40pm	Lambright, K	61-3319
42234	MW	6:30pm - 7:55pm	Faradineh, R	61-3415
42246	MW	7:00pm - 8:25pm	Kojima, T	61-3319
42247	MW	7:00pm - 8:25pm	Alvarado, N	61-3410
42250	TTh	7:00pm - 8:25pm	Lancaster, S	61-2419
42262	TTh	7:00pm - 8:25pm	Lambright, K	61-3319

MATH 110H — Elementary Statistics - Honors **3.0 Units**

Degree Applicable, CSU, UC

Prerequisite: (MATH 71 or MATH 71X or MATH 71B or qualifying passing score on current department placement test) AND acceptance into the Honors Program.

Descriptive/inferential statistics. Honors course with enriched experience. Credit is not given for both MATH 110 and Math 110H.

42127	F	8:30am - 11:40am	Guth, S	61-2306
-------	---	------------------	---------	---------

MATH 110S — Integrated Statistics **5.0 Units**

Degree Applicable, CSU, UC

Prerequisite: MATH 70S

MATH 110S is an elementary statistics course, covering typical topics from descriptive and inferential statistics.

42206	MW	10:45am - 1:20pm	Troxell, C	61-3418
42207	MW	12:30pm - 3:05pm	Guth, S	61-2306
42286	MW	6:00pm - 8:35pm	Guth, S	61-2306

■ **MATH 130 — College Algebra****4.0 Units**

Degree Applicable, CSU, UC

Prerequisite: MATH 71 or MATH 71B or qualifying score on current department placement test

College-level algebra course.

42128 MW 7:30am - 9:35am Munro, M 61-2306

NOTE: CRN 42128 is a part of the Pathways Program and is continuing from the Fall semester. Seats are reserved for students already in the program. Any additional seats will be open for registration to any eligible student. This course is a part of Math Cohort #3. If you have any questions please email pathways@mtsac.edu or call (909) 274-5703.

42129 TTh 7:30am - 9:35am Munro, M 61-2306

NOTE: CRN 42129 above is designed for students in the Bridge Program. Attendance at an information session and special approval are needed to enroll in this learning community. This course is linked to COUN 7 (CRN 44406). For more information, please contact (909)274-5392.

42130 TTh 7:30am - 9:35am Rivers, D 61-3414

42131 TTh 7:30am - 9:35am Takashima, T 61-2310

42132 WF 7:30am - 9:35am Takashima, T 61-2310

42134 MW 8:30am - 10:35am Johnson, M 61-2315

42133 TTh 8:30am - 10:35am Young, P 61-2311

42135 MW 9:45am - 11:50am Mc Mullin, J 61-3410

NOTE: CRN 42135 is a part of the Pathways Program and is continuing from the Winter term. Seats are reserved for students already in the program. Any additional seats will be open for registration to any eligible student. This course is a part of Math Cohort #2. If you have any questions please email pathways@mtsac.edu or call (909) 274-5703.

42136 MW 9:45am - 11:50am Kim, C 61-3406

42137 TTh 9:45am - 11:50am Rivers, D 61-3414

42138 MW 10:45am - 12:50pm Johnson, M 61-2315

42139 MW 12:00pm - 2:05pm Summers, M 61-2406

42140 M 12:00pm - 2:05pm Kim, C 61-3406

and arrange 2.3 hours Kim, C ONLINE

NOTE: CRN 42140 is a 16-week Hybrid Class taught partially online with Schedule Meetings on Campus.

How to Begin Course: Log into Moodle rooms through the eLearning Tools tab in the Mt. SAC portal at my.mtsac.edu. Click on the Moodle rooms link and then click on the CRN for your DL course. **NOTE:** Some courses may not be activated until the start of the term. If you cannot locate your DL course in Moodle rooms when the term starts, contact the professor.

Professor contact info: Email Professor Kim at either: ckim@mtsac.edu, through Student Detail Schedule or Moodle rooms at MyMtSAC Portal.

Students must use their Mt. SAC e-mail account and be aware of course commitments and student expectations described at <http://www.mtsac.edu/instruction/learning/distlearn/>

42141 T 12:00pm - 2:05pm Chavez, D 61-3406

and arrange 2.3 hours Chavez, D ONLINE

NOTE: CRN 42141 is a 16-week Hybrid Class taught partially online with Schedule Meetings on Campus.

How to Begin Course: Log into Moodle rooms through the eLearning Tools tab in the Mt. SAC portal at my.mtsac.edu. Click on the Moodle rooms link and then click on the CRN for your DL course. **NOTE:** Some courses may not be activated until the start of the term. If you cannot locate your DL course in Moodle rooms when the term starts, contact the professor.

Professor contact info: Email Professor Chavez at either: dchavez@mtsac.edu, through Student Detail Schedule or Moodle rooms at MyMtSAC Portal.

Students must use their Mt. SAC e-mail account and be aware of course commitments and student expectations described at <http://www.mtsac.edu/instruction/learning/distlearn/>

42142 Th 12:00pm - 2:05pm Chavez, D 61-3406
and arrange 2.3 hours Chavez, D ONLINE

NOTE: CRN 42142 is a 16-week Hybrid Class taught partially online with Schedule Meetings on Campus.

How to Begin Course: Log into Moodle rooms through the eLearning Tools tab in the Mt. SAC portal at my.mtsac.edu. Click on the Moodle rooms link and then click on the CRN for your DL course. **NOTE:** Some courses may not be activated until the start of the term. If you cannot locate your DL course in Moodle rooms when the term starts, contact the professor.

Professor contact info: Email Professor Chavez at either: dchavez@mtsac.edu, through Student Detail Schedule or Moodle rooms at MyMtSAC Portal.

Students must use their Mt. SAC e-mail account and be aware of course commitments and student expectations described at <http://www.mtsac.edu/instruction/learning/distlearn/>

42143 TTh 1:00pm - 3:05pm Rivas, K 61-2311

42144 MW 2:15pm - 4:20pm Menjivar, J 61-2410

42145 TTh 2:15pm - 4:20pm Ong, H 61-3418

42194 MW 4:30pm - 6:35pm Rivas, K 61-3302**42199 TTh 4:30pm - 6:35pm Nguyen, H 61-3418****42200 MW 6:45pm - 8:50pm Edwards, W 61-2310****42202 TTh 6:45pm - 8:50pm STAFF 61-3418**■ **MATH 140 — Calculus for Business** **4.0 Units**

Degree Applicable, CSU, UC

Prerequisite: MATH 130 or MATH 160 or qualifying score on current department placement test

Calculus for business, social science, and non-science majors.

42146 MW 9:45am - 11:50am Rolle, B 61-2418

42147 TTh 12:00pm - 2:05pm Tamayo, J 61-3419

42148 MW 1:00pm - 3:05pm Tatoian, V 61-2315

42149 TTh 4:30pm - 6:35pm Edwards, W 61-2306**42263 MW 6:45pm - 8:50pm Butenko, A 61-3414**■ **MATH 150 — Trigonometry** **3.0 Units**

Degree Applicable, CSU

Prerequisite: MATH 71 or MATH 71B or qualifying score on current department placement test AND MATH 61 or passing score on current geometry competency test.

Trigonometric and inverse trigonometric functions, including graphs and identities.

42150 MW 8:00am - 9:25am Perez, C 61-3302

42151 TTh 9:45am - 11:10am Garcia, R 61-3410

42152 TTh 11:30am - 12:55pm Mc Mullin, J 61-3410

42212 MW 1:15pm - 2:40pm Childress, S 61-2419

42217 TTh 3:30pm - 4:55pm Childress, S 61-2418

43083 MW 7:00pm - 8:25pm Morales, L 61-2410**42218 TTh 7:00pm - 8:25pm Pyle, L 61-2306**■ **MATH 160 — Precalculus Mathematics** **4.0 Units**

Degree Applicable, CSU, UC

Prerequisite: MATH 150 or qualifying score on current department placement test

Prepares students for the calculus sequence.

42153 TTh 8:30am - 10:35am Wohlgezogen, L 61-2419

42154 MW 9:45am - 11:50am Wohlgezogen, L 61-3310

42155 TTh 12:00pm - 2:05pm Morales, L 61-2319

42156 TTh 2:15pm - 4:20pm Morales, L 61-2319

42157 MW 4:30pm - 6:35pm Beydler, D 61-3411**42228 MW 6:45pm - 8:50pm Beydler, D 61-3411****42272 TTh 6:45pm - 8:50pm Arellano, M 61-3414**

■ MATH 180 — Calculus and Analytic Geometry 4.0 Units

Degree Applicable, CSU, UC

Prerequisite: MATH 160 or qualifying score on current department placement test

Differential and integral calculus with applications.

42158	TTh	8:30am - 10:35am	Perez, C	61-2316
42159	MWF	10:00am - 11:15am	Griffith, H	61-3315
42160	TTh	10:45am - 12:50pm	Perez, C	61-2316
42161	TTh	10:45am - 12:50pm	STAFF	61-3415
42162	MWF	11:30am - 12:45pm	Griffith, H	61-3315
42163	TTh	1:00pm - 3:05pm	Beydler, D	61-3415
42164	MW	2:15pm - 4:20pm	Tran, F	61-2418
42165 MW	4:30pm - 6:32pm	Birca, A	61-2302	61-2302
42166 MW	6:45pm - 8:50pm	Birca, A	61-2302	61-2302
42267 MW	6:45pm - 8:50pm	Rivas, K	61-3302	61-3302
43367 TTh	6:45pm - 8:50pm	Terreri, J	61-3411	61-3411

■ MATH 181 — Calculus and Analytic Geometry 4.0 Units

Degree Applicable, CSU, UC

Prerequisite: MATH 180

Differential and integral calculus with infinite series and applications.

42167	MWF	8:30am - 9:45am	Griffith, H	61-3315
42168	MW	9:45am - 11:50am	Young, P	61-2410
42169	MW	10:45am - 12:50pm	Nguyen, B	61-3319
42170	TTh	10:45am - 12:50pm	Nguyen, B	61-3319
42171	MW	12:00pm - 2:05pm	Young, P	61-2410
42191	MWF	1:00pm - 2:15pm	Griffith, H	61-3315
42203 MW	4:30pm - 6:35pm	Tran, F	61-2418	61-2418
42211 TTh	4:30pm - 6:35pm	Lai, I	61-3419	61-3419
42265 MW	6:45pm - 8:50pm	STAFF	61-2418	61-2418

■ MATH 280 — Calculus and Analytic Geometry 5.0 Units

Degree Applicable, CSU, UC

Prerequisite: MATH 181

Multivariate and vector calculus, which includes vectors in two and three space and surfaces in space.

42172	MW	8:00am - 10:35am	Nguyen, B	61-3319
42173	MWF	9:45am - 11:20am	Zicree, S	61-3415
42174	MWF	11:00am - 12:35pm	Kojima, T	61-2311
42264	TThF	11:30am - 1:05pm	Lancaster, S	61-2419
42213	MW	12:30pm - 3:05pm	Tamayo, J	61-3419
43368 TTh	6:00pm - 8:35pm	Childress, S	61-2418	61-2418

■ MATH 285 — Linear Algebra and Differential Equations 5.0 Units

Degree Applicable, CSU, UC

Prerequisite: MATH 280

Linear algebra and ordinary differential equations.

42175	TTh	8:00am - 10:35am	Nguyen, B	61-3319
42201	MW	12:00pm - 1:25pm	Tran, F	61-2418
	and F	12:00pm - 2:05pm	Tran, F	61-2418
42226	MW	1:30pm - 4:05pm	Kojima, T	61-3319
44575 MW	7:00pm - 9:35pm	Tran, F	61-3315	61-3315

MEDICAL TERMINOLOGY

■ MEDI 90 — Medical Terminology 3.0 Units

Degree Applicable, CSU

Medical terminology used in various allied health fields.

41467	W	8:30am - 11:40am	Orr, J	67A-206
41508	M	3:00pm - 6:10pm	Butler, G	28B-106
41465	T	3:30pm - 6:40pm	Graffeo, N	67A-233
41466 W	6:30pm - 9:40pm	Graffeo, N	67A-206	67A-206
41548 Th	6:30pm - 9:40pm	Butler, J	67A-150	67A-150

MENTAL HEALTH/PSYCHIATRIC TECHNICIAN

■ MENT 40 — Introduction to Interviewing and Counseling 3.0 Units

Not Degree Applicable

41327	M	12:30pm - 3:40pm	James-Perez, S	67A-233
-------	---	------------------	----------------	---------

■ MENT 56 — Medical-Surgical Nursing for Psychiatric Technicians 9.0 Units

Degree Applicable

Prerequisite: Admission to the Psychiatric Technician Program

Corequisite: MENT 56L

41328	TW	7:30am - 11:55am	Mc Graw, J	67A-205
	and T	1:00pm - 3:05pm	Gilbert, C	67A-205
41329	TW	7:30am - 11:55am	Reyes, M	67A-215
	and W	1:00pm - 3:05pm	Gilbert, C	67A-215

■ MENT 56L — Medical-Surgical Clinical Experience 4.0 Units

Degree Applicable

(May be taken for Pass/No Pass Only)

Corequisite: MENT 56

41330	ThF	7:00am - 12:05pm	Mc Graw, J	HOSP
	and Th	12:30pm - 3:00pm	Mc Graw, J	HOSP
		and arrange .75 hour	Mc Graw, J	HOSP
41331	ThF	7:00am - 12:05pm	Reyes, M	HOSP
	and Th	12:30pm - 3:00pm	Reyes, M	HOSP
		and arrange .75 hour	Reyes, M	HOSP
41332	ThF	7:00am - 12:05pm	Yates, S	HOSP
	and Th	12:30pm - 3:00pm	Yates, S	HOSP
		and arrange .75 hour	Yates, S	HOSP
41333	ThF	7:00am - 12:05pm	Tull, A	HOSP
	and Th	12:30pm - 3:00pm	Tull, A	HOSP
		.75 hour	Tull, A	HOSP

■ MENT 72 — Nursing Care of the Developmentally Disabled Person 7.0 Units

Degree Applicable

Prerequisite: MENT 56, MENT 56L, MENT 70, MENT 70L

Corequisite: MENT 72L

41334	TWTh	1:00pm - 3:25pm	Hernandez, C	67A-225
41335	TWTh	1:00pm - 3:25pm	Nixon, B	67A-233

■ MENT 72L — Nursing Care of the Developmentally Disabled Person - Clinical 5.5 Units

Degree Applicable

(May be taken for Pass/No Pass Only)

Corequisite: MENT 72

41336	TWThF	7:30am - 11:45am	Hernandez, C	HOSP
41337	TWThF	7:30am - 11:45am	Gilbert, C	HOSP
41338	TWThF	7:30am - 11:45am	Badre, A	HOSP
44457	TWThF	7:30am - 11:45am	Nixon, B	HOSP

■ MENT 73L — Psychiatric Nursing for Psychiatric Technicians Clinical 5.5 Units

Degree Applicable

(May be taken for Pass/No Pass Only)

Prerequisite: Admission to Psychiatric Technician Program. MENT 56 and MENT 56L

Corequisite: MENT 73T

41339	WTh	7:00am - 12:05pm	Gonzalez, G	HOSP
	and WTh	12:30pm - 3:35pm	James-Perez, S	HOSP
		and arrange 1.75 hours	Gonzalez, G	HOSP
41340	WTh	7:00am - 12:05pm	Sanchez, A	HOSP
	and WTh	12:30pm - 3:35pm	Sanchez, A	HOSP
		and arrange 1.94 hours	Caraffa, S	HOSP
41341	WTh	7:00am - 12:05pm	Felten, A	HOSP
	and WTh	12:30pm - 3:35pm	Garcia, S	HOSP
		and arrange 1.94 hours	Felten, A	HOSP

MENT 73T — Psychiatric Nursing for Psychiatric Technicians 6.0 Units

Degree Applicable

Prerequisite: MENT 56 MENT 56L

Corequisite: MENT 73L PSYC 1A

Advisory: MENT 40

41342	MT	8:30am - 11:50am	Sanchez, A	67A-233
41522	MT	8:30am - 11:50am	Tull, A	67A-225

MENT 82 — Work Experience in Mental Health Technology 2.0 Units

Degree Applicable

(May be taken for Pass/No Pass Only)

Prerequisite: Compliance with Work Experience regulations as designated in the College Catalog, MENT 72, and MENT 73T

On-the-job experience at an approved work site. Requires 150 paid or 120 non-paid hours.

41343	arrange	9.38 hours	Hernandez, C	18C
44445	arrange	25 hours	James-Perez, S	18C

6 Weeks, Week beginning 02/26/2018 ending 04/09/2018

NOTE: MENT 82 Work Experience, CRN 44445 is only for eligible students who are in the Alcohol Drug Program.

44446	arrange	25 hours	James-Perez, S	18C
-------	---------	----------	----------------	-----

6 Weeks, Week beginning 04/10/2018 ending 05/21/2018

NOTE: MENT 82 Work Experience, CRN 44446 is only for eligible students who are in the Alcohol Drug Program.

METEOROLOGY

METO 3 — Weather and the Atmospheric Environment 3.0 Units

Degree Applicable, CSU, UC

An introduction to the atmosphere. May include field work and/or field trips.

41914	TTh	8:00am - 9:25am	Webb, C	60-1512
41915	TTh	9:45am - 11:10am	Webb, C	60-1512
41983	W	6:30pm - 9:40pm	Mendenhall, L	60-1512

METO 3L — Weather and Atmospheric Environment Laboratory 1.0 Unit

Degree Applicable, CSU, UC

Corequisite: METO 3 (May have been taken previously)

Laboratory applications and problem-solving related to the atmospheric environment.

41916	T	1:15pm - 4:25pm	Webb, C	60-1511
-------	---	-----------------	---------	---------

MICROBIOLOGY

MICR 1 — Principles of Microbiology 5.0 Units

Degree Applicable, CSU, UC

Prerequisite: CHEM 10 or CHEM 40

Microbial classification, physiology, genetics, immunology, and host-microbe interactions. Field trips required.

41765	MW	8:00am - 9:25am	Wright, C	7-1104
	and MW	9:45am - 12:55pm	Wright, C	60-2506

MICR 22 — Microbiology 4.0 Units

Degree Applicable, CSU, UC

Prerequisite: CHEM 10 or CHEM 40

Advisory: BIOL 1 or BIOL 4 or BIOL 4H

Fundamental concepts of microbiology including viruses, bacteria, fungi, protozoa and parasitic worms.

41768	TTh	8:00am - 9:25am	Anderson, C	7-1104
	and TTh	9:45am - 11:10am	Anderson, C	60-2506
41769	TTh	8:00am - 9:25am	Anderson, C	7-1104
	and TTh	11:30am - 12:55pm	Anderson, C	60-2506
41766	MW	11:30am - 12:55pm	Briggs, C	7-1104
	and MW	1:15pm - 2:40pm	Briggs, C	60-2506
41767	MW	11:30am - 12:55pm	Briggs, C	7-1104
	and MW	3:00pm - 4:25pm	Briggs, C	60-2506
41770	TTh	11:30am - 12:55pm	Lee, M	7-1104
	and TTh	1:15pm - 2:40pm	Lee, M	60-2506
41771	TTh	11:30am - 12:55pm	Lee, M	7-1104
	and TTh	3:00pm - 4:25pm	Kaur, R	60-2506
41774	MW	3:30pm - 4:55pm	Anderson, C	7-1104
	and MW	5:15pm - 6:40pm	Anderson, C	60-2506
41772	MW	5:20pm - 6:45pm	Spitzer, J	7-1104
	and MW	7:00pm - 8:25pm	Spitzer, J	60-2506
41773	TTh	5:20pm - 6:45pm	Kaur, R	60-2506
	and TTh	7:00pm - 8:25pm	Kaur, R	7-1104

MUSIC

MUS 2 — Music Theory 3.0 Units

Degree Applicable, CSU, UC

(C-ID MUS 120)

Corequisite: MUS 5A

Preparation for the study of Harmony and form as it is practiced in Western tonal music. Required for music majors.

43904	MW	8:00am - 9:25am	Mahpar, S	13-1245
-------	----	-----------------	-----------	---------

MUS 3A — Harmony - Diatonic 3.0 Units

Degree Applicable, CSU, UC

Prerequisite: MUS 2

Corequisite: MUS 5B

An examination of harmony and form as it is practiced in Western tonal music. This course covers diatonic harmony.

44030	MW	8:00am - 9:25am	Bowen, R	2-M117
-------	----	-----------------	----------	--------

MUS 3C — Harmony - Chromatic II 3.0 Units

Degree Applicable, CSU, UC

Prerequisite: MUS 3B

Corequisite: MUS 6B

Examination of harmony and form as it is practiced in Western tonal music with a focus on advanced chromatic harmony.

44032	TTh	8:00am - 9:25am	Bowen, R	2-M117
-------	-----	-----------------	----------	--------

MUS 5A — Musicianship - Ear Training and Sight Singing 1.0 Unit

Degree Applicable, CSU, UC

(C-ID MUS 125)

Corequisite: MUS 2

Training in sight singing, rhythm reading, aural recognition and dictation. Required for music majors.

44052	MW	9:45am - 11:10am	Mahpar, S	13-1245
-------	----	------------------	-----------	---------

MUS 5B — Musicianship - Diatonic 1.0 Unit

Degree Applicable, CSU, UC

(C-ID MUS 135)

Prerequisite: MUS 5A

Corequisite: MUS 3A

Training in sight singing, rhythm reading, aural recognition and dictation.

44053	MW	9:45am - 11:10am	Bowen, R	2-M117
-------	----	------------------	----------	--------

■ **MUS 6B — Musicianship - Chromatic II** **1.0 Unit**
(C-ID MUS 155) Degree Applicable, CSU, UC

Prerequisite: MUS 6A
Corequisite: MUS 3C

Sight singing and dictation of music with borrowed chords, linear chromaticism and modulation to foreign keys.

44054 TTh 9:45am - 11:10am Bowen, R 2-M117

■ **MUS 7 — Fundamentals of Music** **3.0 Units**
(C-ID MUS 110) Degree Applicable, CSU, UC

Introduction to music notation and the elements of music.

44055 MW 8:00am - 9:25am Whitmore, G 2-M119

44056 MW 9:45am - 11:10am Whitmore, G 2-M119

44059 TTh 9:45am - 11:10am Harrison, A 13-1245

44057 MW 11:30am - 12:55pm Bowen, R 2-M117

NOTE: CRN 44057: No-cost digital textbooks or textual materials used

44060 TTh 11:30am - 12:55pm Bowen, R 2-M117

NOTE: CRN 44060: No-cost digital textbooks or textual materials used

44058 MW 1:15pm - 2:40pm Myers-Mc Kenzie, L 2-M117

44061 TTh 1:15pm - 2:40pm Myers-Mc Kenzie, L 2-M117

44062 M 7:00pm - 10:10pm Harrison, A 2-M117

■ **MUS 9 — Introduction to Music Technology** **3.0 Units**
Degree Applicable, CSU

(May be taken for option of Letter grade or Pass/NoPass)

Advisory: Eligibility for ENGL 68

Uses of computers and electronic devices to capture, create, modify and disseminate music.

44063 MW 11:30am - 12:20pm Tharp, N 13-2425

and MW 12:30pm - 2:10pm Tharp, N 13-2425

NOTE: CRN 44063: No-cost digital textbooks or textual materials used

44064 MW 3:00pm - 4:05pm Tharp, N 13-2425

and MW 4:15pm - 5:40pm Tharp, N 13-2425

NOTE: CRN 44064: No-cost digital textbooks or textual materials used

44065 S 9:00am - 11:05am Alverson, D 13-2425

and S 11:15am - 2:25pm Alverson, D 13-2425

NOTE: CRN 44065: No-cost digital textbooks or textual materials used

■ **MUS 10B — Keyboard Skills** **1.0 Unit**
Degree Applicable, CSU, UC

Prerequisite: MUS 10A or admission by audition

Keyboard (piano) skills required for music majors including harmonization of melodies, sight-reading, improvisation, and theory.

43738 MW 8:00am - 9:20am Leung, M 2-M102

■ **MUS 11B — Music Literature Survey** **3.0 Units**
Degree Applicable, CSU, UC

Western music of the 18th - 21st C. including influences of non-western cultures. Attending at least one live concert is required.

43741 MW 11:30am - 12:55pm Kuo, T 1B/C-1

■ **MUS 12 — History of Jazz** **3.0 Units**
Degree Applicable, CSU, UC

Advisory: Eligibility for ENGL 68.

A survey of jazz as a significant American art form from its roots in African music to the present.

43748 TTh 8:00am - 9:25am Harrison, L 2-M119

NOTE: CRN 43748: No-cost digital textbooks or textual materials used

43750 MW 9:45am - 11:10am Mc Intosh, W 2-M104

43759 TTh 9:45am - 11:10am Ellwood, J 2-M119

NOTE: CRN 43759: No-cost digital textbooks or textual materials used

43751 MW 11:30am - 12:55pm Ellwood, J 2-M119

NOTE: CRN 43751: No-cost digital textbooks or textual materials used

43762 TTh 11:30am - 12:55pm Ellwood, J 2-M119

NOTE: CRN 43762: No-cost digital textbooks or textual materials used

43752 MW 1:15pm - 2:40pm Stier, G 2-M104

NOTE: CRN 43752: No-cost digital textbooks or textual materials used

43763 TTh 1:15pm - 2:40pm Stier, G 2-M107

NOTE: CRN 43763: No-cost digital textbooks or textual materials used

43754 MW 3:00pm - 4:25pm Mc Intosh, W 2-M104

■ **MUS 13 — Introduction to Music Appreciation** **3.0 Units**
(C-ID MUS 100) Degree Applicable, CSU, UC

Western music from the medieval period through the 21st century. Attending at least one live concert is required.

43765 MW 8:00am - 9:25am Chevalier, A 2-M107

NOTE: CRN 43765: No-cost digital textbooks or textual materials used

43808 F 8:00am - 11:10am Jones, J 2-M107

43787 MW 9:45am - 11:10am Chevalier, A 2-M107

NOTE: CRN 43787: No-cost digital textbooks or textual materials used

43792 MW 11:30am - 12:55pm Stier, G 2-M107

NOTE: CRN 43792: No-cost digital textbooks or textual materials used

43810 F 11:30am - 2:40pm Jones, J 2-M107

43794 MW 1:15pm - 2:40pm Anastasia, S 2-M107

NOTE: CRN 43794: No-cost digital textbooks or textual materials used

43801 W 3:00pm - 6:10pm Anastasia, S 2-M107

NOTE: CRN 43801: No-cost digital textbooks or textual materials used

43804 Th 3:00pm - 6:10pm Martin, M 1B/C-1

NOTE: CRN 43804: No-cost digital textbooks or textual materials used

43767 arrange 3.38 hours Marston, K ONLINE

NOTE: CRN 43767 is a Distance Learning Online Class. No-cost digital textbooks or textual materials used.

How to Begin Course: Log into Canvas through <http://myportal.mtsac.edu> and click on CRN for your DL course. **NOTE:** Some courses may not be activated until the start of the term. If you cannot locate your DL course in Canvas when the term starts, contact the professor.

Professor contact info: Email Professor Marston at either: kmarston1@mtsac.edu, through Student Detail Schedule or Canvas at MyMt-SAC Portal.

Students must use their Mt. SAC e-mail account and be aware of course commitment and student expectations described at <http://www.mtsac.edu/instruction/learning/distlearn/>

To prepare for a successful online learning experience, see helpful short videos at <http://www.mtsac.edu/distancelearning/quiz/>

43768 arrange 3.38 hours Marston, K ONLINE

NOTE: CRN 43768 is a Distance Learning Online Class. No-cost digital textbooks or textual materials used.

How to Begin Course: Log into Canvas through <http://myportal.mtsac.edu> and click on CRN for your DL course. **NOTE:** Some courses may not be activated until the start of the term. If you cannot locate your DL course in Canvas when the term starts, contact the professor.

Professor contact info: Email Professor Marston at either: kmarston1@mtsac.edu, through Student Detail Schedule or Canvas at MyMt-SAC Portal.

Students must use their Mt. SAC e-mail account and be aware of course commitment and student expectations described at <http://www.mtsac.edu/instruction/learning/distlearn/>

To prepare for a successful online learning experience, see helpful short videos at <http://www.mtsac.edu/distancelearning/quiz/>

43770 arrange 3.38 hours Marston, K ONLINE

NOTE: CRN 43770 is a Distance Learning Online Class. No-cost digital textbooks or textual materials used.

How to Begin Course: Log into Canvas through <http://myportal.mtsac.edu> and click on CRN for your DL course. **NOTE:** Some courses may not be activated until the start of the term. If you cannot locate your DL course in Canvas when the term starts, contact the professor.

Professor contact info: Email Professor Marston at either: kmarston1@mtsac.edu, through Student Detail Schedule or Canvas at MyMt-SAC Portal.

Students must use their Mt. SAC e-mail account and be aware of course commitment and student expectations described at <http://www.mtsac.edu/instruction/learning/distlearn/>

To prepare for a successful online learning experience, see helpful short videos at <http://www.mtsac.edu/distancelearning/quiz/>

43772 arrange 3.38 hours Marston, K ONLINE

NOTE: CRN 43772 is a Distance Learning Online Class. No-cost digital textbooks or textual materials used.**How to Begin Course:** Log into Canvas through <http://myportal.mtsac.edu> and click on CRN for your DL course. **NOTE:** Some courses may not be activated until the start of the term. If you cannot locate your DL course in Canvas when the term starts, contact the professor.**Professor contact info:** Email Professor Marston at either: kmarston1@mtsac.edu, through Student Detail Schedule or Canvas at MyMtSAC Portal.**Students must use their Mt. SAC e-mail account and be aware of course commitment and student expectations described at <http://www.mtsac.edu/instruction/learning/distlearn/>**To prepare for a successful online learning experience, see helpful short videos at <http://www.mtsac.edu/distancelearning/quiz/>

43774 arrange 3.38 hours Cahow, M ONLINE

NOTE: CRN 43774 is a Distance Learning Online Class. No-cost digital textbooks or textual materials used.**How to Begin Course:** Log into Canvas through <http://myportal.mtsac.edu> and click on CRN for your DL course. **NOTE:** Some courses may not be activated until the start of the term. If you cannot locate your DL course in Canvas when the term starts, contact the professor.**Professor contact info:** Email Professor Cahow at either: mcahow@mtsac.edu, through Student Detail Schedule or Canvas at MyMtSAC Portal.**Students must use their Mt. SAC e-mail account and be aware of course commitment and student expectations described at <http://www.mtsac.edu/instruction/learning/distlearn/>**To prepare for a successful online learning experience, see helpful short videos at <http://www.mtsac.edu/distancelearning/quiz/>

43779 arrange 3.38 hours Cahow, M ONLINE

NOTE: CRN 43779 is a Distance Learning Online Class. No-cost digital textbooks or textual materials used.**How to Begin Course:** Log into Canvas through <http://myportal.mtsac.edu> and click on CRN for your DL course. **NOTE:** Some courses may not be activated until the start of the term. If you cannot locate your DL course in Canvas when the term starts, contact the professor.**Professor contact info:** Email Professor Cahow at either: mcahow@mtsac.edu, through Student Detail Schedule or Canvas at MyMtSAC Portal.**Students must use their Mt. SAC e-mail account and be aware of course commitment and student expectations described at <http://www.mtsac.edu/instruction/learning/distlearn/>**To prepare for a successful online learning experience, see helpful short videos at <http://www.mtsac.edu/distancelearning/quiz/>

43783 arrange 3.38 hours Cahow, M ONLINE

NOTE: CRN 43783 is a Distance Learning Online Class. No-cost digital textbooks or textual materials used.**How to Begin Course:** Log into Canvas through <http://myportal.mtsac.edu> and click on CRN for your DL course. **NOTE:** Some courses may not be activated until the start of the term. If you cannot locate your DL course in Canvas when the term starts, contact the professor.**Professor contact info:** Email Professor Cahow at either: mcahow@mtsac.edu, through Student Detail Schedule or Canvas at MyMtSAC Portal.**Students must use their Mt. SAC e-mail account and be aware of course commitment and student expectations described at <http://www.mtsac.edu/instruction/learning/distlearn/>**To prepare for a successful online learning experience, see helpful short videos at <http://www.mtsac.edu/distancelearning/quiz/>

44576 arrange 3.38 hours Marston, K ONLINE

NOTE: CRN 44576 is a Distance Learning Online Class. No-cost digital textbooks or textual materials used.**How to Begin Course:** Log into Canvas through <http://myportal.mtsac.edu> and click on CRN for your DL course. **NOTE:** Some courses may not be activated until the start of the term. If you cannot locate your DL course in Canvas when the term starts, contact the professor.**Professor contact info:** Email Professor Marston at either: kmarston1@mtsac.edu, through Student Detail Schedule or Canvas at MyMtSAC Portal.**Students must use their Mt. SAC e-mail account and be aware of course commitment and student expectations described at <http://www.mtsac.edu/instruction/learning/distlearn/>**To prepare for a successful online learning experience, see helpful short videos at <http://www.mtsac.edu/distancelearning/quiz/>**■ MUS 13H — Introduction to Music Appreciation - Honors 3.0 Units**
(C-ID MUS 100) Degree Applicable, CSU, UC*Prerequisite: Acceptance into the Honors Program*

Honors course providing enriched experience. May not receive credit for both MUS 13 and MUS 13H. Must attend one live concert.

43815 MW 9:45am - 11:10am Kuo, T 1B/C-1

NOTE: CRN 43815 above is linked to ENGL 1CH (CRN 42690) and is designated for students in the Honors Fast Track Program. Please call the Honors Program at (909)274-4665 for further information.

43821 MW 1:15pm - 2:40pm Kuo, T 1B/C-1

NOTE: CRN 43821: No-cost digital textbooks or textual materials used**■ MUS 14A — World Music 3.0 Units**
Degree Applicable, CSU, UC*Advisory: Eligibility for ENGL 68*

Examines the music of Africa, the Americas, Europe, and Asia and compares it to western popular music.

43827 TTh 11:30am - 12:55pm Martin, M 1B/C-1

NOTE: CRN 43827: No-cost digital textbooks or textual materials used

43823 TTh 1:15pm - 2:40pm Martin, M 1B/C-1

NOTE: CRN 43823: No-cost digital textbooks or textual materials used**■ MUS 14B — American Folk Music 3.0 Units**
Degree Applicable, CSU, UC

The study of American folk music by both region and period. No musical experience required.

43828 MW 1:15pm - 2:40pm WidELITZ, N 2-M119

NOTE: CRN 43828: No-cost digital textbooks or textual materials used**■ MUS 15 — Rock Music History and Appreciation 3.0 Units**
Degree Applicable, CSU, UC

Historical survey of rock music from its beginnings in the early 1950s to the present.

43829 MW 8:00am - 9:25am Adele, D 2-M104

44600 MW 8:00am - 9:25am Altmire, M 13-1220

43833 TTh 8:00am - 9:25am Fabiero, K 2-M104

44596 MW 9:45am - 11:10am Altmire, M 13-1220

43834 TTh 9:45am - 11:10am Fabiero, K 2-M104

43830 MW 11:30am - 12:55pm Myers-Mc Kenzie, L 2-M104

43835 TTh 11:30am - 12:55pm Tharp, N 2-M104

NOTE: CRN 43835: No-cost digital textbooks or textual materials used

43836 TTh 1:15pm - 2:40pm Tharp, N 2-M104

NOTE: CRN 43836: No-cost digital textbooks or textual materials used

43831 M 3:30pm - 6:40pm Domingues, C 2-M119

NOTE: CRN 43831: No-cost digital textbooks or textual materials used

43837 T 3:30pm - 6:40pm Domingues, C 2-M119

NOTE: CRN 43837: No-cost digital textbooks or textual materials used

43832 M 7:00pm - 10:10pm Carroll, D 2-M104

43838 T 7:00pm - 10:10pm Carroll, D 2-M104

43839 T 7:00pm - 10:10pm Domingues, C 2-M119

NOTE: CRN 43839: No-cost digital textbooks or textual materials used

43840 W 7:00pm - 10:10pm Alverson, D 2-M104

NOTE: CRN 43840: No-cost digital textbooks or textual materials used

43841 S 8:00am - 2:30pm Jones, J 2-M107

8 Weeks, Week beginning 02/26/2018 ending 04/22/2018

MUS 16 — Individual Instruction **.5 Unit**

Degree Applicable, CSU, UC

(May be taken four times for credit)

Prerequisite: Admission by audition

Private lessons for students in a major performing group. Weekly class meeting required.

43880 F 11:15am - 12:40pm Marston, K 2-M139
and arrange .5 hour Marston, K 2-M139**NOTE:** CRN # 43880 above is for brass (low) students.43883 F 11:15am - 12:40pm Laronga, B 2-M109
and arrange .5 hour Laronga, B 2-M109**NOTE:** CRN # 43883 above is for brass (high) students.43843 T 11:30am - 12:55pm STAFF 2-M200
and arrange .5 hour STAFF 2-M200**NOTE:** CRN # 43843 above is for instrumental (jazz) students.43886 F 11:30am - 12:55pm Harrison, L 2-M108
and arrange .5 hour Harrison, L 2-M108**NOTE:** CRN # 43886 above is for vocal (jazz) students.43888 F 12:45pm - 2:10pm Fabiero, K 2-M139
and arrange .5 hour Stoutenborough, L**NOTE:** CRN # 43888 above is for woodwinds students.43842 M 1:15pm - 2:40pm Harrison, L 2-M139
and arrange .5 hour Harrison, L 2-M139**NOTE:** CRN # 43842 above is for vocal (classical) students.43844 W 6:00pm - 7:25pm Campos, A 2-M200
and arrange .5 hour Campos, A 2-M139**NOTE:** CRN # 43844 above is for percussion students.43875 W 7:30pm - 8:55pm Shiao, Y 2-M109
and arrange .5 hour Shiao, Y**NOTE:** CRN # 43875 above is for string students.**MUS 17A — Elementary Piano** **1.0 Unit**

Degree Applicable, CSU, UC

Reading and performance of piano literature. No prior musical experience is required.

43890 TTh 8:00am - 9:25am Klassen, M 2-M102

43893 MW 9:45am - 11:10am Haines, J 2-M102

43892 TTh 9:45am - 11:10am Klassen, M 2-M102

43894 MW 11:30am - 12:55pm Haines, J 2-M102

43896 MW 1:15pm - 2:40pm Haines, J 2-M102

43897 MW 3:00pm - 4:25pm Haines, J 2-M102

43898 TTh 3:00pm - 4:25pm Leung, M 2-M102

MUS 17B — Intermediate Piano **1.0 Unit**

Degree Applicable, CSU, UC

Advisory: MUS 17A

Reading and performances of piano literature with emphasis on major and minor scales.

43900 TTh 11:30am - 12:55pm Klassen, M 2-M102

MUS 18 — Advanced Piano **1.0 Unit**

Degree Applicable, CSU, UC

Advisory: MUS 17B

Style, technique, and interpretation of piano literature from 17th century to present through improvisation and ensemble playing.

43902 TTh 11:30am - 12:55pm Klassen, M 2-M102

MUS 20A — Elementary Voice **1.0 Unit**

Degree Applicable, CSU, UC

Group singing instruction with an emphasis on breathing and posture, performance techniques, and vocal quality.

43907 TTh 9:45am - 11:10am Harrison, L 2-M109

NOTE: CRN 43907: No-cost digital textbooks or textual materials used

43906 MW 11:30am - 12:55pm Anastasia, S 2-M109

43910 TTh 11:30am - 12:55pm STAFF 2-M109

43909 MW 3:00pm - 4:25pm WidELITZ, N 2-M109

MUS 20B — Intermediate Voice **1.0 Unit**

Degree Applicable, CSU, UC

Advisory: MUS 20A

Group and individual instruction concentrating on individual vocal development and singing techniques including foreign languages.

43911 TTh 9:45am - 11:10am Tomlinson, R 2-M108

43912 MW 1:15pm - 2:40pm St Marie, J 2-M109

NOTE: CRN 43912: No-cost digital textbooks or textual materials used**MUS 21 — Advanced Voice** **1.0 Unit**

Degree Applicable, CSU, UC

Advisory: MUS 20B

Style, technique, and interpretation of art and theatrical song. Emphasis on diction in Italian, German, and French.

43913 TTh 9:45am - 11:10am Tomlinson, R 2-M108

44620 MW 1:15pm - 2:40pm St Marie, J 2-M109

NOTE: CRN 44620: No-cost digital textbooks or textual materials used**MUS 23A — Elementary Guitar** **1.0 Unit**

Degree Applicable, CSU, UC

Acoustic guitar playing, note reading, strumming, finger picking, and improvisation. Students must furnish their own guitars.

43916 MW 11:30am - 12:55pm Adele, D 2-M101

43927 TTh 11:30am - 12:55pm Lo Piccolo, J 2-M101

43919 MW 1:15pm - 2:40pm Adele, D 2-M101

43914 TTh 1:15pm - 2:40pm Lo Piccolo, J 2-M101

43915 TTh 3:00pm - 4:25pm Lo Piccolo, J 2-M101

MUS 23B — Intermediate Guitar **1.0 Unit**

Degree Applicable, CSU, UC

Advisory: MUS 23A

Techniques for reading and playing music arranged for the solo guitar. Students must furnish their own acoustic guitar.

43934 MW 3:00pm - 4:25pm Adele, D 2-M101

MUS 24 — Advanced Guitar **1.0 Unit**

Degree Applicable, CSU, UC

Advisory: MUS 23B

Guitar music from 18th and 19th centuries. Sight reading and ensemble playing. Students must furnish their own acoustic guitars.

43935 MW 3:00pm - 4:25pm Adele, D 2-M101

MUS 27 — Chamber Music **1.5 Units**

(C-ID MUS 180) Degree Applicable, CSU, UC

(May be taken four times for credit)

Prerequisite: Admission by audition

Select ensemble of winds, strings, guitar, and percussionists performing chamber music. Required Off-campus public performances.

43936 F 8:00am - 11:10am Whitmore, G 2-M200

and arrange 1.1 hours Whitmore, G 2-M200

MUS 30 — Collegiate Chorale **1.0 Unit**

Degree Applicable, CSU, UC

(May be taken four times for credit)

A non-auditioned mixed choral ensemble open to all students. Attendance at performances is required.

43937 MW 9:45am - 11:10am St Marie, J 2-M108

43938 W 6:30pm - 9:40pm St Marie, J 2-M108

MUS 31 — Concert Choir **1.5 Units**

Degree Applicable, CSU, UC

(May be taken four times for credit)

Prerequisite: Admission by audition

Large mixed choral ensemble. Attendance at performances including those off-site is required. Auditions held first week.

43939 MW 11:30am - 12:55pm Mc Intosh, W 2-M108

and arrange 1.1 hours Mc Intosh, W 2-M108

■ **MUS 34 — Women's Vocal Ensemble** **1.0 Unit**
Degree Applicable, CSU, UC

(May be taken four times for credit)

Prerequisite: Admission by audition during the first week of class

Women's vocal ensemble. Attendance at performances including off-campus locations is required. Auditions held the first week.

43940 TTh 11:30am - 12:55pm Tomlinson, R 2-M108

■ **MUS 38 — Ensemble** **.5 Unit**
Degree Applicable, CSU, UC

(May be taken four times for credit)

Prerequisite: Ability to read music or admission by audition

Study and perform music written for small ensembles. On campus performances may be required.

43941 MW 11:30am - 12:35pm Whitmore, G 2-M200

43942 TTh 11:30am - 12:35pm STAFF 2-M200

43946 TTh 11:30am - 12:35pm Marston, K 2-M139

NOTE: CRN # 43946 above is for Brass Choir.

43943 MW 3:00pm - 4:05pm Rogers, B 2-M108

43944 W 6:00pm - 8:05pm Campos, A 2-M200

43945 W 7:30pm - 9:35pm Shiao, Y 2-M109

NOTE: CRN # 43945 above is for String Orchestra.

■ **MUS 39 — Laboratory Band** **2.0 Units**
Degree Applicable, CSU

(May be taken four times for credit)

Prerequisite: Admission by audition

Open to students with prior instrumental experience. Audition may be required.

44027 TTh 1:15pm - 3:35pm STAFF 2-M200

and arrange 2.25 hours STAFF

■ **MUS 44 — Vocal Jazz Ensemble** **2.0 Units**
Degree Applicable, CSU, UC

(May be taken four times for credit)

Prerequisite: Admission by audition

A mixed vocal jazz group. Attendance at performances and competitions is required. Auditions held the first week of classes.

44593 TTh 1:15pm - 3:20pm Mc Intosh, W 2-M109

and arrange 2.25 hours Mc Intosh, W 2-M109

44035 MW 4:30pm - 6:35pm Rogers, B 2-M109

and arrange 2.25 hours Rogers, B 2-M109

■ **MUS 45 — Chamber Singers** **2.0 Units**
(C-ID MUS 180) Degree Applicable, CSU, UC

(May be taken four times for credit)

Prerequisite: Admission by audition

Premier mixed choral group. Attendance at performances including off-campus locations is required. Auditions are held each May.

44037 MW 3:00pm - 4:05pm Rogers, B 2-M108

and F 8:30am - 11:20am Rogers, B 2-M108

and arrange 1.75 hours Rogers, B 2-M108

■ **MUS 47 — Jazz Ensemble** **2.0 Units**
Degree Applicable, CSU, UC

(May be taken four times for credit)

Prerequisite: Admission by audition.

Study and performance of jazz and big band music. Off-campus public performance required. Admission by audition.

44039 MW 2:15pm - 4:20pm Ellwood, J 2-M200

and arrange 2.5 hours Ellwood, J 2-M200

■ **MUS 48 — Men's Vocal Ensemble** **2.0 Units**
Degree Applicable, CSU, UC

(May be taken four times for credit)

Prerequisite: Admission by audition the first week of class

A men's vocal ensemble. Attendance at performances including off-campus locations is required. Auditions held the first week.

44040 MW 1:05pm - 2:55pm Mc Intosh, W 2-M109

and arrange 3.4 hours Mc Intosh, W 2-M109

■ **MUS 49 — Wind Ensemble** **2.0 Units**
(C-ID MUS 180) Degree Applicable, CSU, UC

(May be taken four times for credit)

Prerequisite: Admission by audition

The premier classical wind and percussion ensemble. Auditions are required. Public performances are required.

44041 MW 11:30am - 1:45pm Whitmore, G 2-M200

and arrange 2.25 hours Whitmore, G 2-M200

■ **MUS 50 — Jazz Improvisation and Performance Choir** **2.0 Units**
(C-ID MUS 180) Degree Applicable, CSU

(May be taken four times for credit)

(May be taken for option of Letter grade or Pass/NoPass)

Prerequisite: Admission by audition

Premier vocal jazz choir. Admission by audition. Off-campus performances are required.

44771 TTh 1:15pm - 3:20pm Mc Intosh, W 2-M109

and arrange 2.25 hours Mc Intosh, W 2-M109

44770 MW 4:30pm - 6:35pm Rogers, B 2-M109

and arrange 2.25 hours Rogers, B 2-M109

■ **MUS 99 — Special Projects in Music** **1.0 Unit**
Degree Applicable, CSU

44772 3.37 hours STAFF

NURSING

■ **NURS 1A — The Nursing Process I** **5.0 Units**
Degree Applicable, CSU

Prerequisite: Admission to Nursing Program; ANAT 35 or equivalent and ANAT 36 or equivalent, or ANAT 10A or equivalent and ANAT 10B or equivalent, and MICR 22 or equivalent, or MICR 1 or equivalent, and ENGL 1A or equivalent

Corequisite: NURS 2

41272 M 7:00am - 10:50am Berch, K 67A-150

and M 1:00pm - 2:35pm Berch, K 67A-150

and arrange 16.88 hours Berch, K BROOK

8 Weeks, Week beginning 02/26/2018 ending 04/22/2018

41273 M 7:00am - 10:50am Berch, K 67A-150

and M 1:00pm - 2:35pm Berch, K 67A-150

and arrange 16.88 hours Andrada-Mamisay, D PKVSTA

8 Weeks, Week beginning 02/26/2018 ending 04/22/2018

41274 M 7:00am - 10:50am Berch, K 67A-150

and M 1:00pm - 2:35pm Berch, K 67A-150

and arrange 16.88 hours Boyer, M SILVER

8 Weeks, Week beginning 02/26/2018 ending 04/22/2018

41275 M 7:00am - 10:50am Berch, K 67A-150

and M 1:00pm - 2:35pm Berch, K 67A-150

and arrange 16.88 hours Hernandez, A HILL

8 Weeks, Week beginning 02/26/2018 ending 04/22/2018

41276 M 7:00am - 10:50am Berch, K 67A-150

and M 1:00pm - 2:35pm Berch, K 67A-150

and arrange 16.88 hours Anderson-Perry, C SILVAL

8 Weeks, Week beginning 02/26/2018 ending 04/22/2018

41277 M 7:00am - 10:50am Berch, K 67A-150

and M 1:00pm - 2:35pm Berch, K 67A-150

and arrange 16.88 hours Boyer, M SILVER

8 Weeks, Week beginning 02/26/2018 ending 04/22/2018

■ NURS 1B — The Nursing Process II**5.0 Units**

Degree Applicable, CSU

Prerequisite: *NURS 1A*Corequisite: *NURS 2*

41278	M	7:00am - 10:50am	Boyer, M	67A-150
and	M	1:00pm - 2:35pm	Boyer, M	67A-150
		and arrange 16.88 hours	Boyer, M	CHINO
8 Weeks, Week beginning 04/23/2018 ending 06/17/2018				
41279	M	7:00am - 10:50am	Boyer, M	67A-150
and	M	1:00pm - 2:35pm	Boyer, M	67A-150
		and arrange 16.88 hours	Orr, J	CHINO
8 Weeks, Week beginning 04/23/2018 ending 06/17/2018				
41280	M	7:00am - 10:50am	Boyer, M	67A-150
and	M	1:00pm - 2:35pm	Boyer, M	67A-150
		and arrange 16.88 hours	Berch, K	SARH
8 Weeks, Week beginning 04/23/2018 ending 06/17/2018				
41281	M	7:00am - 10:50am	Boyer, M	67A-150
and	M	1:00pm - 2:35pm	Boyer, M	67A-150
		and arrange 16.88 hours	Harrington, M	CCHCH
8 Weeks, Week beginning 04/23/2018 ending 06/17/2018				
41282	M	7:00am - 10:50am	Boyer, M	67A-150
and	M	1:00pm - 2:35pm	Boyer, M	67A-150
		and arrange 16.88 hours	STAFF	PVHMC
8 Weeks, Week beginning 04/23/2018 ending 06/17/2018				
41283	M	7:00am - 10:50am	Boyer, M	67A-150
and	M	1:00pm - 2:35pm	Boyer, M	67A-150
		and arrange 16.88 hours	STAFF	PIH
8 Weeks, Week beginning 04/23/2018 ending 06/17/2018				

■ NURS 2 — Pharmacology**2.0 Units**

Degree Applicable, CSU

Prerequisite: *Admission to Nursing Program and eligibility for MATH 51*Corequisite: *NURS 1A*

41284	Th	7:30am - 10:20am	Romero, O	67A-150
12 Weeks, Week beginning 02/26/2018 ending 05/20/2018				
41574	Th	7:30am - 10:20am	Romero, O	67A-150
12 Weeks, Week beginning 02/26/2018 ending 05/20/2018				

■ NURS 3 — Medical-Surgical Nursing:**3.5 Units****Locomotion/Sensory/Integ/Oncology/Immu**

Degree Applicable, CSU

Prerequisite: *NURS 1B and NURS 2 or Advanced Placement*

41285	M	7:00am - 10:50am	Orr, J	67A-206
and	M	1:00pm - 2:30pm	Orr, J	67A-206
		and arrange 18 hours	Orr, J	CHINO
6 Weeks, Week beginning 02/26/2018 ending 04/08/2018				
41286	M	7:00am - 10:50am	Orr, J	67A-206
and	M	1:00pm - 2:30pm	Orr, J	67A-206
		and arrange 18 hours	Nln, T	FOOT
6 Weeks, Week beginning 02/26/2018 ending 04/08/2018				
41287	M	7:00am - 10:50am	Orr, J	67A-206
and	M	1:00pm - 2:30pm	Orr, J	67A-206
		and arrange 18 hours	Coleman, D	PVHMC
6 Weeks, Week beginning 02/26/2018 ending 04/08/2018				
41288	M	7:00am - 10:50am	Orr, J	67A-206
and	M	1:00pm - 2:30pm	Orr, J	67A-206
		and arrange 18 hours	Hauw, W	SARH
6 Weeks, Week beginning 02/26/2018 ending 04/08/2018				
41289	M	7:00am - 10:50am	Orr, J	67A-206
and	M	1:00pm - 2:30pm	Orr, J	67A-206
		and arrange 18 hours	Mccarty, A	PIH
6 Weeks, Week beginning 02/26/2018 ending 04/08/2018				
41290	M	7:00am - 10:50am	Orr, J	67A-206
and	M	1:00pm - 2:30pm	Orr, J	67A-206
		and arrange 18 hours	Reyes, A	ICC
5 Weeks, Week beginning 02/26/2018 ending 04/08/2018				

■ NURS 4 — Maternity Nursing**3.0 Units**

Degree Applicable, CSU

Prerequisite: *NURS 3 or Advanced Placement*

41291	M	7:00am - 9:50am	Condra, D	67A-206
and	M	1:00pm - 3:30pm	Smith, K	67A-206
		and arrange 16.2 hours	STAFF	PVHMC
5 Weeks, Week beginning 04/09/2018 ending 05/13/2018				
41292	M	7:00am - 9:50am	Condra, D	67A-206
and	M	1:00pm - 3:30pm	STAFF	67A-206
		and arrange 16.2 hours	STAFF	QOVH
5 Weeks, Week beginning 04/09/2018 ending 05/13/2018				
41293	M	7:00am - 9:50am	Condra, D	67A-206
and	M	1:00pm - 3:30pm	Cannon, S	67A-206
		and arrange 16.2 hours	STAFF	SARH
5 Weeks, Week beginning 04/09/2018 ending 05/13/2018				
41294	M	7:00am - 9:50am	Condra, D	67A-206
and	M	1:00pm - 3:30pm	STAFF	67A-206
		and arrange 16.2 hours	STAFF	PVHMC
5 Weeks, Week beginning 04/09/2018 ending 05/13/2018				
41295	M	7:00am - 9:50am	Condra, D	67A-206
and	M	1:00pm - 3:30pm	Carter, D	67A-206
		and arrange 16.2 hours	STAFF	WHIT
5 Weeks, Week beginning 04/09/2018 ending 05/13/2018				
41296	M	7:00am - 9:50am	Condra, D	67A-206
and	M	1:00pm - 3:30pm	Cailipan, A	67A-206
		and arrange 16.2 hours	STAFF	QOVH
5 Weeks, Week beginning 04/09/2018 ending 05/13/2018				

■ NURS 5 — Psychiatric Nursing**3.0 Units**

Degree Applicable, CSU

Prerequisite: *NURS 7 or NURS 70 (Advanced Placement) and PSYC 1A or PSYC 1AH*

41297	M	7:00am - 9:50am	Anderson-Perry, C	67A-205
and	M	1:00pm - 3:30pm	Anderson-Perry, C	67A-205
		and arrange 16.2 hours	Anderson-Perry, C	BHC
5 Weeks, Week beginning 05/14/2018 ending 06/17/2018				
41298	M	7:00am - 9:50am	Anderson-Perry, C	67A-205
and	M	1:00pm - 3:30pm	Elmgren, M	67A-205
		and arrange 16.2 hours	Fuentes, W	CHART
5 Weeks, Week beginning 05/14/2018 ending 06/17/2018				
41299	M	7:00am - 9:50am	Anderson-Perry, C	67A-205
and	M	1:00pm - 3:30pm	Macaraeg, A	67A-205
		and arrange 16.2 hours	STAFF	CHC
5 Weeks, Week beginning 05/14/2018 ending 06/17/2018				
41300	M	7:00am - 9:50am	Anderson-Perry, C	67A-205
and	M	1:00pm - 3:30pm	Mahood, K	67A-205
		and arrange 16.2 hours	STAFF	CHART
5 Weeks, Week beginning 05/14/2018 ending 06/17/2018				
41301	M	7:00am - 9:50am	Anderson-Perry, C	67A-205
and	M	1:00pm - 3:30pm	Kassiss, N	67A-205
		and arrange 16.2 hours	STAFF	CHART
5 Weeks, Week beginning 05/14/2018 ending 06/17/2018				
41302	M	7:00am - 9:50am	Anderson-Perry, C	67A-205
and	M	1:00pm - 3:30pm	STAFF	67A-205
		and arrange 16.2 hours	STAFF	HOSP
5 Weeks, Week beginning 05/14/2018 ending 06/17/2018				

■ NURS 6 — Pediatric Nursing **3.0 Units**

Degree Applicable, CSU

Prerequisite: NURS 4 or NURS 70 (Advanced Placement) and CHLD 10 or CHLD 10H or PSYC 14

41303	M	7:00am - 9:50am	Berch, K	67A-206
and	M	1:00pm - 3:30pm	Kunkler, C	67A-206
	and arrange	16.2 hours	Hinson, J	PVHMC
5 Weeks, Week beginning 05/14/2018 ending 06/17/2018				
41304	M	7:00am - 9:50am	Berch, K	67A-206
and	M	1:00pm - 3:30pm	Kunkler, C	67A-206
	and arrange	16.2 hours	Ford-Charles, C	WHIT
5 Weeks, Week beginning 05/14/2018 ending 06/17/2018				
41305	M	7:00am - 9:50am	Berch, K	67A-206
and	M	1:00pm - 3:30pm	Kunkler, C	67A-206
	and arrange	16.2 hours	Vy, V	HUNT
5 Weeks, Week beginning 05/14/2018 ending 06/17/2018				
41306	M	7:00am - 9:50am	Berch, K	67A-206
and	M	1:00pm - 3:30pm	Kunkler, C	67A-206
	and arrange	16.2 hours	Abate, A	PVHMC
5 Weeks, Week beginning 05/14/2018 ending 06/17/2018				
41307	M	7:00am - 9:50am	Berch, K	67A-206
and	M	1:00pm - 3:30pm	Kunkler, C	67A-206
	and arrange	16.2 hours	Radnoti, S	CHLA
5 Weeks, Week beginning 05/14/2018 ending 06/17/2018				
41308	M	7:00am - 9:50am	Berch, K	67A-206
and	M	1:00pm - 3:30pm	Kunkler, C	67A-206
	and arrange	16.2 hours	Nava, M	QOVH
5 Weeks, Week beginning 05/14/2018 ending 06/17/2018				

■ NURS 7 — Medical-Surgical Nursing: Nutrition/Elimination/Surgical Asepsis **7.0 Units**

Degree Applicable, CSU

Prerequisite: NURS 6 or Advanced Placement

41309	M	7:00am - 10:50am	Ontiveros, J	67A-205
and	M	1:00pm - 3:15pm	Perez, L	67A-205
	and arrange	17.18 hours	STAFF	SARH
11 Weeks, Week beginning 02/26/2018 ending 05/13/2018				
41310	M	7:00am - 10:50am	Ontiveros, J	67A-205
and	M	1:00pm - 3:15pm	Perez, L	67A-205
	and arrange	17.18 hours	Dunaway, J	HOSP
11 Weeks, Week beginning 02/26/2018 ending 05/13/2018				
41311	M	7:00am - 10:50am	Ontiveros, J	67A-205
and	M	1:00pm - 3:15pm	Perez, L	67A-205
	and arrange	17.18 hours	Marquez, A	PVHMC
11 Weeks, Week beginning 02/26/2018 ending 05/13/2018				
41312	M	7:00am - 10:50am	Ontiveros, J	67A-205
and	M	1:00pm - 3:15pm	Perez, L	67A-205
	and arrange	17.18 hours	Ontiveros, J	HOSP
11 Weeks, Week beginning 02/26/2018 ending 05/13/2018				
41313	M	7:00am - 10:50am	Ontiveros, J	67A-205
and	M	1:00pm - 3:15pm	Perez, L	67A-205
	and arrange	17.18 hours	Ha Nguyen, A	QOVH
11 Weeks, Week beginning 02/26/2018 ending 05/13/2018				
41542	M	7:00am - 10:50am	Ontiveros, J	67A-205
and	M	1:00pm - 3:15pm	Perez, L	67A-205
	and arrange	17.18 hours	Riggs, A	ICC
11 Weeks, Week beginning 02/26/2018 ending 05/13/2018				

■ NURS 8 — Medical-Surgical Nursing: Circulation and Oxygenation **5.0 Units**

Degree Applicable, CSU

*Prerequisite: NURS 5 or Advanced Placement (NURS 70)**Corequisite: NURS 9*

41314	M	7:00am - 9:50am	Hooper, J	67A-216
and	Th	7:00am - 10:15am	Hooper, J	67A-216
	and arrange	19.29 hours	Hooper, J	SARH
7 Weeks, Week beginning 02/26/2018 ending 04/15/2018				
41315	M	7:00am - 9:50am	Hooper, J	67A-216
and	Th	7:00am - 10:15am	Hooper, J	67A-216
	and arrange	19.29 hours	Chen, G	QOVH
7 Weeks, Week beginning 02/26/2018 ending 04/15/2018				
41316	M	7:00am - 9:50am	Hooper, J	67A-216
and	Th	7:00am - 10:15am	Hooper, J	67A-216
	and arrange	19.29 hours	Perez, L	PIH
7 Weeks, Week beginning 02/26/2018 ending 04/15/2018				
41317	M	7:00am - 9:50am	Hooper, J	67A-216
and	Th	7:00am - 10:15am	Hooper, J	67A-216
	and arrange	19.29 hours	Rutherford, E	ICC
7 Weeks, Week beginning 02/26/2018 ending 04/15/2018				
41318	M	7:00am - 9:50am	Hooper, J	67A-216
and	Th	7:00am - 10:15am	Hooper, J	67A-216
	and arrange	19.29 hours	Romero, O	ICC
7 Weeks, Week beginning 02/26/2018 ending 04/15/2018				
41319	M	7:00am - 9:50am	Hooper, J	67A-216
and	Th	7:00am - 10:15am	Hooper, J	67A-216
	and arrange	19.29 hours	Lynes, B	PVHMC
7 Weeks, Week beginning 02/26/2018 ending 04/15/2018				

■ NURS 9 — Leadership in Nursing **1.0 Unit**

Degree Applicable, CSU

*Prerequisite: NURS 5 or Advanced Placement (NURS 70)**Corequisite: NURS 9*

41320	M	1:00pm - 3:50pm	Chen, G	67A-216
6 Weeks, Week beginning 02/26/2018 ending 04/02/2018				

■ NURS 10 — Medical-Surgical Nursing: Integration/Regulation **4.0 Units**

Degree Applicable, CSU

Prerequisite: NURS 8 and NURS 9, or Advanced Placement (NURS 70)

41321	M	8:00am - 10:50am	Perez, L	67A-216
and	M	1:00pm - 2:50pm	Perez, L	67A-216
and	Th	8:30am - 11:00am	Perez, L	67A-216
	and arrange	13.5 hours	Romero, O	ICC
6 Weeks, Week beginning 04/16/2018 ending 05/27/2018				
41322	M	8:00am - 10:50am	Perez, L	67A-216
and	M	1:00pm - 2:50pm	Perez, L	67A-216
and	Th	8:30am - 11:00am	Perez, L	67A-216
	and arrange	13.5 hours	Chen, G	QOVH
6 Weeks, Week beginning 04/16/2018 ending 05/27/2018				
41323	M	8:00am - 10:50am	Perez, L	67A-216
and	M	1:00pm - 2:50pm	Perez, L	67A-216
and	Th	8:30am - 11:00am	Perez, L	67A-216
	and arrange	13.5 hours	Hooper, J	SARH
6 Weeks, Week beginning 04/16/2018 ending 05/27/2018				
41324	M	8:00am - 10:50am	Perez, L	67A-216
and	M	1:00pm - 2:50pm	Perez, L	67A-216
and	Th	8:30am - 11:00am	Perez, L	67A-216
	and arrange	13.5 hours	Rutherford, E	PIH
6 Weeks, Week beginning 04/16/2018 ending 05/27/2018				
41325	M	8:00am - 10:50am	Perez, L	67A-216
and	M	1:00pm - 2:50pm	Perez, L	67A-216
and	Th	8:30am - 11:00am	Perez, L	67A-216
	and arrange	13.5 hours	Lynes, B	PVHMC
6 Weeks, Week beginning 04/16/2018 ending 05/27/2018				
41326	M	8:00am - 10:50am	Perez, L	67A-216
and	M	1:00pm - 2:50pm	Perez, L	67A-216
and	Th	8:30am - 11:00am	Perez, L	67A-216
	and arrange	13.5 hours	STAFF	ICC
6 Weeks, Week beginning 04/16/2018 ending 05/27/2018				

You are what you eat . . .
Make a **HEALTHIER** you!

Take a
Nutrition and Foods
class to learn how!

NF10: Nutrition for Personal Health and Wellness

NF25: Essentials of Nutrition

NF28: Cultural and Ethnic Foods

REGISTER TODAY!

3 UNITS
Meets Area E General Education Requirements

■ NURS 11 — Preceptorship in Nursing

2.0 Units

Degree Applicable, CSU

(May be taken for Pass/No Pass Only)

Prerequisite: NURS 10 or Advanced Placement

41510	arrange	36 hours	Chen, G	HOSP
	3 Weeks, Week beginning 05/28/2018 ending 06/17/2018			
41511	arrange	36 hours	Hooper, J	HOSP
	3 Weeks, Week beginning 05/28/2018 ending 06/17/2018			
41512	arrange	36 hours	STAFF	HOSP
	3 Weeks, Week beginning 05/28/2018 ending 06/17/2018			
41513	arrange	36 hours	STAFF	HOSP
	3 Weeks, Week beginning 05/28/2018 ending 06/17/2018			
41514	arrange	36 hours	STAFF	HOSP
	3 Weeks, Week beginning 05/28/2018 ending 06/17/2018			
41518	arrange	36 hours	STAFF	PVHMC
	3 Weeks, Week beginning 05/28/2018 ending 06/17/2018			

NUTRITION AND FOOD

■ NF 1 — Introduction to Nutrition as a Career

1.5 Units

Degree Applicable, CSU

Prerequisite: NF 10, or NF 25, or NF 25H

Careers and career preparation in nutrition, dietetics, and food science. Field trips may be required.

41043	T	6:30pm - 7:55pm	Impara, C	78-1150
-------	---	-----------------	-----------	---------

■ NF 10 — Nutrition for Health and Wellness

3.0 Units

Degree Applicable, CSU

Prerequisite: Eligibility for ENGL 68

Principles of nutrition and their relationship to optimum health and wellness. Course is intended for non-health science majors.

41151	MW	8:00am - 9:25am	Cammayo, C	78-1150
41137	TTh	8:00am - 9:25am	Cammayo, C	78-1150
41219	MW	9:45am - 11:10am	Buzby, L	78-1150
41045	TTh	9:45am - 11:10am	Ahmed, R	78-1150
41044	TTh	11:30am - 12:55pm	Manarino, M	78-1150
41047	M	12:00pm - 3:10pm	Berenji, N	78-1150
41188	TTh	1:15pm - 2:40pm	Manarino, M	78-1150
41187	M	6:30pm - 9:40pm	STAFF	78-1150
41046	arrange	3.4 hours	Hass, J	ONLINE

NOTE: CRN 41046 is a Distance Learning Online Class.

How to Begin Course: Log into Canvas through the eLearning Tools tab in the Mt. SAC portal at my.mtsac.edu. Then click on the Canvas link and then click on CRN for your DL course. **NOTE:** Some courses may not be activated until the start of the term. If you cannot locate your DL course in Canvas when the term starts, contact the professor. **On the first day of classes, log into your DL course to show your "attendance" because not doing so could result in your being dropped from the class for non-attendance.**

Professor contact info: Email Professor Hass at either: JHass@mtsac.edu, through Student Detail Schedule Canvas at MyMtSAC Portal.

Students must use their Mt. SAC e-mail account and be aware of course commitment and student expectations described at <http://www.mtsac.edu/instruction/learning/distlearn/>

To prepare for a successful online learning experience, see helpful short videos <http://www.mtsac.edu/distancelearning/quiz/>

41048	arrange	3.4 hours	Weatherilt, S	ONLINE
-------	---------	-----------	---------------	--------

NOTE: CRN 41048 is a Distance Learning Online Class.

How to Begin Course: Log into Canvas through the eLearning Tools tab in the Mt. SAC portal at my.mtsac.edu. Then click on the Canvas link and then click on CRN for your DL course. **NOTE:** Some courses may not be activated until the start of the term. If you cannot locate your DL course in Canvas when the term starts, contact the professor. **On the first day of classes, log into your DL course to show your "attendance" because not doing so could result in your being dropped from the class for non-attendance.**

Professor contact info: Email Professor Weatherilt at either: SWeatherilt@mtsac.edu, through Student Detail Schedule Canvas at MyMtSAC Portal.

Students must use their Mt. SAC e-mail account and be aware of course commitment and student expectations described at <http://www.mtsac.edu/instruction/learning/distlearn/>

To prepare for a successful online learning experience, see helpful short videos <http://www.mtsac.edu/distancelearning/quiz/>

44208	arrange	3.4 hours	Hass, J	ONLINE
-------	---------	-----------	---------	--------

NOTE: CRN 44208 is a Distance Learning Online Class.

How to Begin Course: Log into Canvas through the eLearning Tools tab in the Mt. SAC portal at my.mtsac.edu. Then click on the Canvas link and then click on CRN for your DL course. **NOTE:** Some courses may not be activated until the start of the term. If you cannot locate your DL course in Canvas when the term starts, contact the professor. **On the first day of classes, log into your DL course to show your "attendance" because not doing so could result in your being dropped from the class for non-attendance.**

Professor contact info: Email Professor Weatherilt at either: SWeatherilt@mtsac.edu, through Student Detail Schedule Canvas at MyMtSAC Portal.

Students must use their Mt. SAC e-mail account and be aware of course commitment and student expectations described at <http://www.mtsac.edu/instruction/learning/distlearn/>

To prepare for a successful online learning experience, see helpful short videos <http://www.mtsac.edu/distancelearning/quiz/>

■ **NF 12 — Sports Nutrition** **3.0 Units**
Degree Applicable, CSU, UC

Prerequisite: Eligibility for ENGL 68

Principles of sports nutrition applied to the athlete and active individual.

41152	TTh	9:45am - 11:10am	Weatherilt, S	78-1140
41233	T	1:15pm - 2:40pm	Basile, T	78-1140
		and arrange 1.75 hours	Basile, T	ONLINE

NOTE: CRN 41233 is a Hybrid Class taught partially online with scheduled meetings on campus.

How to Begin Course: Log into Canvas through the eLearning Tools tab in the Mt. SAC portal at my.mtsac.edu. Then click on the Canvas link and then click on CRN for your DL course. **NOTE:** Some courses may not be activated until the start of the term. If you cannot locate your DL course in Canvas when the term starts, contact the professor. **On the first day of classes, log into your DL course to show your "attendance" because not doing so could result in your being dropped from the class for non-attendance.**

Professor contact info: Email Professor Basile at either: TBasile@mtsac.edu, through Student Detail Schedule or Canvas at MyMtSAC Portal.

Students must use their Mt. SAC e-mail account and be aware of course commitment and student expectations described at <http://www.mtsac.edu/instruction/learning/distlearn/>

To prepare for a successful online learning experience, see helpful short videos <http://www.mtsac.edu/distancelearning/quiz/>

44210	arrange	3.4 hours	Weatherilt, S	ONLINE
-------	---------	-----------	---------------	--------

NOTE: CRN 44210 is a Distance Learning Online Class.

How to Begin Course: Log into Canvas through the eLearning Tools tab in the Mt. SAC portal at my.mtsac.edu. Then click on the Canvas link and then click on CRN for your DL course. **NOTE:** Some courses may not be activated until the start of the term. If you cannot locate your DL course in Canvas when the term starts, contact the professor. **On the first day of classes, log into your DL course to show your "attendance" because not doing so could result in your being dropped from the class for non-attendance.**

Professor contact info: Email Professor Weatherilt at either: SWeatherilt@mtsac.edu, through Student Detail Schedule or Canvas at MyMtSAC Portal.

Students must use their Mt. SAC e-mail account and be aware of course commitment and student expectations described at <http://www.mtsac.edu/instruction/learning/distlearn/>

To prepare for a successful online learning experience, see helpful short videos <http://www.mtsac.edu/distancelearning/quiz/>

44211	arrange	3.4 hours	Basile, T	ONLINE
-------	---------	-----------	-----------	--------

NOTE: CRN 442101 is a Distance Learning Online Class.

How to Begin Course: Log into Canvas through the eLearning Tools tab in the Mt. SAC portal at my.mtsac.edu. Then click on the Canvas link and then click on CRN for your DL course. **NOTE:** Some courses may not be activated until the start of the term. If you cannot locate your DL course in Canvas when the term starts, contact the professor. **On the first day of classes, log into your DL course to show your "attendance" because not doing so could result in your being dropped from the class for non-attendance.**

Professor contact info: Email Professor Basile at either: TBasile@mtsac.edu, through Student Detail Schedule or Canvas at MyMtSAC Portal.

Students must use their Mt. SAC e-mail account and be aware of course commitment and student expectations described at <http://www.mtsac.edu/instruction/learning/distlearn/>

To prepare for a successful online learning experience, see helpful short videos <http://www.mtsac.edu/distancelearning/quiz/>

■ **NF 20 — Principles of Food with Lab** **3.0 Units**
Degree Applicable, CSU

Prerequisite: Eligibility for ENGL 68 and Eligibility for MATH 50

Application of food science principles.

41132	M	9:45am - 11:50am	Cammayo, C	78-1140
	and M	12:00pm - 3:10pm	Cammayo, C	78-1140
41049	W	9:45am - 11:50am	Metter, J	78-1140
	and W	12:00pm - 3:10pm	Metter, J	78-1140

■ **NF 25 — Introduction to Nutrition Science** **3.0 Units**
Degree Applicable, CSU, UC

Prerequisite: Eligibility for ENGL 68

Scientific concepts of nutrition related to the function of nutrients and current health issues with emphasis on individual needs.

41189	MW	8:00am - 9:25am	Buzby, L	78-1130
41054	MW	9:45am - 11:10am	Day, A	78-1130
41051	T	9:45am - 11:10am	Metter, J	TBA
		and arrange 1.7 hours	Metter, J	ONLINE

NOTE: CRN 41051 is a Hybrid Class taught partially online with scheduled meetings on campus.

How to Begin Course: Log into Canvas through the eLearning Tools tab in the Mt. SAC portal at my.mtsac.edu. Then click on the Canvas link and then click on CRN for your DL course. **NOTE:** Some courses may not be activated until the start of the term. If you cannot locate your DL course in Canvas when the term starts, contact the professor. **On the first day of classes, log into your DL course to show your "attendance" because not doing so could result in your being dropped from the class for non-attendance.**

Professor contact info: Email Professor Metter at either: JMetter@mtsac.edu, through Student Detail Schedule or Canvas at MyMtSAC Portal.

Students must use their Mt. SAC e-mail account and be aware of course commitment and student expectations described at <http://www.mtsac.edu/instruction/learning/distlearn/>

To prepare for a successful online learning experience, see helpful short videos <http://www.mtsac.edu/distancelearning/quiz/>

41052	TTh	9:45am - 11:10am	Alvarado, A	78-1130
41055	MW	11:30am - 12:55pm	Fantazia, J	78-1130
41220	T	11:30am - 12:55pm	Metter, J	TBA
		and arrange 1.7 hours	Metter, J	ONLINE

NOTE: CRN 41220 is a Hybrid Class taught partially online with scheduled meetings on campus.

How to Begin Course: Log into Canvas through the eLearning Tools tab in the Mt. SAC portal at my.mtsac.edu. Then click on the Canvas link and then click on CRN for your DL course. **NOTE:** Some courses may not be activated until the start of the term. If you cannot locate your DL course in Canvas when the term starts, contact the professor. **On the first day of classes, log into your DL course to show your "attendance" because not doing so could result in your being dropped from the class for non-attendance.**

Professor contact info: Email Professor Metter at either: JMetter@mtsac.edu, through Student Detail Schedule or Canvas at MyMtSAC Portal.

Students must use their Mt. SAC e-mail account and be aware of course commitment and student expectations described at <http://www.mtsac.edu/instruction/learning/distlearn/>

To prepare for a successful online learning experience, see helpful short videos <http://www.mtsac.edu/distancelearning/quiz/>

41050	TTh	11:30am - 12:55pm	Alvarado, A	78-1130
44213	TTh	1:15pm - 2:40pm	Alvarado, A	78-1130
41053	arrange	3.4 hours	Impara, C	ONLINE

NOTE: CRN 41053 is a Distance Learning Online Class.

How to Begin Course: Log into Canvas through the eLearning Tools tab in the Mt. SAC portal at my.mtsac.edu. Then click on the Canvas link and then click on CRN for your DL course. **NOTE:** Some courses may not be activated until the start of the term. If you cannot locate your DL course in Canvas when the term starts, contact the professor. **On the first day of classes, log into your DL course to show your "attendance" because not doing so could result in your being dropped from the class for non-attendance.**

Professor contact info: Email Professor Impara at either: CImpara@mtsac.edu, through Student Detail Schedule or Canvas at MyMtSAC Portal.

Students must use their Mt. SAC e-mail account and be aware of course commitment and student expectations described at <http://www.mtsac.edu/instruction/learning/distlearn/>

To prepare for a successful online learning experience, see helpful short videos <http://www.mtsac.edu/distancelearning/quiz/>

41056 arrange 3.4 hours Basile, T ONLINE
NOTE: CRN 41056 is a Distance Learning Online Class.

How to Begin Course: Log into Canvas through the eLearning Tools tab in the Mt. SAC portal at my.mtsac.edu. Then click on the Canvas link and then click on CRN for your DL course. **NOTE:** Some courses may not be activated until the start of the term. If you cannot locate your DL course in Canvas when the term starts, contact the professor. **On the first day of classes, log into your DL course to show your "attendance" because not doing so could result in your being dropped from the class for non-attendance.**

Professor contact info: Email Professor T. Basile at either: TBasile@mtsac.edu, through Student Detail Schedule or Canvas at MyMtSAC Portal.

Students must use their Mt. SAC e-mail account and be aware of course commitment and student expectations described at <http://www.mtsac.edu/instruction/learning/distlearn/>

To prepare for a successful online learning experience, see helpful short videos <http://www.mtsac.edu/distancelearning/quiz/>

41264 arrange 3.4 hours Impara, C ONLINE
NOTE: CRN 41264 is a Distance Learning Online Class.

How to Begin Course: Log into Canvas through the eLearning Tools tab in the Mt. SAC portal at my.mtsac.edu. Then click on the Canvas link and then click on CRN for your DL course. **NOTE:** Some courses may not be activated until the start of the term. If you cannot locate your DL course in Canvas when the term starts, contact the professor. **On the first day of classes, log into your DL course to show your "attendance" because not doing so could result in your being dropped from the class for non-attendance.**

Professor contact info: Email Professor Impara at either: CImpara@mtsac.edu, through Student Detail Schedule or Canvas at MyMtSAC Portal.

Students must use their Mt. SAC e-mail account and be aware of course commitment and student expectations described at <http://www.mtsac.edu/instruction/learning/distlearn/>

To prepare for a successful online learning experience, see helpful short videos <http://www.mtsac.edu/distancelearning/quiz/>

■ **NF 28 — Cultural and Ethnic Foods** 3.0 Units
 Degree Applicable, CSU, UC

Prerequisite: Eligibility for ENGL 68

Regional, ethnic, cultural, religious, historical and social influences on food patterns and cuisines.

41221 TTh 11:30am - 12:55pm Cammayo, C 78-1140

■ **NF 30 — Food Science Technologies** 3.0 Units
 Degree Applicable, CSU

Prerequisite: Eligibility for ENGL 68 Eligibility for MATH 50

Food chemistry, food processing and technology and how it affects the color, flavor, texture, aroma and quality of foods.

44214 W 6:30pm - 9:40pm STAFF 78-1140

■ **NF 81 — Cooking for Your Heart and Health** 1.0 Unit
 Not Degree Applicable

(May be taken for option of Letter grade or Pass/NoPass)

Prerequisite: HRM 52 or NF 20 or NF 10 or NF 25

Advisory: Basic food preparation knowledge, skills, and experience

Principles and techniques of healthful food preparation. Off-campus meetings may be required.

44381 F 9:45am - 11:05am Metter, J 78-1140
 and F 11:15am - 1:35pm Metter, J 78-1140
8 Weeks, Week beginning 04/23/2018 ending 06/17/2018

■ **NF 82 — Vegetarian Cuisine** 1.0 Unit
 Not Degree Applicable

(May be taken for option of Letter grade or Pass/NoPass)

Prerequisite: HRM 52 or NF 10 or NF 20 or NF 25

Principles and techniques of vegetarian food preparation. Off-campus meetings may be required.

44217 F 9:45am - 11:15am Metter, J 78-1140
 and F 11:25am - 2:00pm Metter, J 78-1140
8 Weeks, Week beginning 02/26/2018 ending 04/22/2018

■ **NF 91 — Work Experience in Nutrition and Dietetics** 1.0 Unit
 Not Degree Applicable

(May be taken for Pass/No Pass Only)

Prerequisite: Compliance with Work Experience regulations as designated in the College Catalog.

On-the-job experience. 75 paid or 60 unpaid hours required for each unit of credit. Instructor approval required.

41213 arrange 3.75 hours Alvarado, A OCAM
NOTE: CRN 41213 Provides the student with on-the-job experience in an approved work site. A minimum of 75 paid hours or 60 non-paid hours per term is required for each unit of credit. Work experience placement is not guaranteed. Student must contact Career Services Specialist, Dawn Finley at dfinley@mtsac.edu by January 22, 2018

■ **NF 91 — Work Experience in Nutrition and Dietetics** 2.0 Units
 Not Degree Applicable

(May be taken for Pass/No Pass Only)

Prerequisite: Compliance with Work Experience regulations as designated in the College Catalog.

On-the-job experience. 75 paid or 60 unpaid hours required for each unit of credit. Instructor approval required.

41267 arrange 9.38 hours Alvarado, A OCAM
NOTE: CRN 41267 Provides the student with on-the-job experience in an approved work site. A minimum of 75 paid hours or 60 non-paid hours per term is required for each unit of credit. Work experience placement is not guaranteed. Student must contact Career Services Specialist, Dawn Finley at dfinley@mtsac.edu by January 22, 2018

■ **NF 91 — Work Experience in Nutrition and Dietetics** 3.0 Units
 Not Degree Applicable

(May be taken for Pass/No Pass Only)

Prerequisite: Compliance with Work Experience regulations as designated in the College Catalog.

On-the-job experience. 75 paid or 60 unpaid hours required for each unit of credit. Instructor approval required.

41269 arrange 14.06 hours Alvarado, A OCAM
NOTE: CRN 41269 Provides the student with on-the-job experience in an approved work site. A minimum of 75 paid hours or 60 non-paid hours per term is required for each unit of credit. Work experience placement is not guaranteed. Student must contact Career Services Specialist, Dawn Finley at dfinley@mtsac.edu by January 22, 2018

OCEANOGRAPHY

■ OCEA 10 — Introduction to Oceanography 3.0 Units

Degree Applicable, CSU, UC

Geological, chemical, physical, and biological aspects of the Earth's ocean.

41917	MW	8:00am - 9:25am	Johnpeer, G	11-2115
41918	TTh	8:00am - 9:25am	Ellaboudy, A	11-2209
41919	Th	8:00am - 11:10am	STAFF	60-1511
41921	MW	9:45am - 11:10am	Johnpeer, G	11-2115
41926	M	9:45am - 12:55pm	Anders, T	60-1511

NOTE: OCEA 10 (CRN 41926) is linked to OCEA 10L (CRN 41960). If you want to register for CRN 41926 you must enter both CRNS (41926 and 41960) in the registration screen. Please call the Natural Sciences Division at (909) 274-4425 if you have any questions.

41925	TTh	9:45am - 11:10am	Ellaboudy, A	11-2209
41929	MW	11:30am - 12:55pm	Regalado, S	11-2209
41973	TTh	11:30am - 12:55pm	Anders, T	11-2209
41991	MW	1:15pm - 2:40pm	Regalado, S	11-2209
41992	TTh	1:15pm - 2:40pm	Anders, T	11-2209
41997	MW	5:00pm - 6:25pm	Smith, L	11-2209
43390	M	6:30pm - 9:40pm	Roberts, C	11-2209
43391	T	6:30pm - 9:40pm	Roberts, C	11-2209
41920	S	9:00am - 12:10pm	STAFF	11-2209

■ OCEA 10L — Introduction to Oceanography Laboratory 1.0 Unit

Degree Applicable, CSU, UC

Corequisite: OCEA 10 or OCEA 10H (May have been taken previously)

Laboratory applications and problem-solving in oceanography.

41922	T	8:00am - 11:10am	Walker, R	60-1511
41960	W	9:45am - 12:55pm	Anders, T	60-1511

NOTE: OCEA 10L (CRN 41960) is linked to OCEA 10 (CRN 41926). If you want to register for CRN 41960 you must enter both CRNS (41960 and 41926) in the registration screen. Please call the Natural Sciences Division at (909) 274-4425 if you have any questions.

41993	M	1:15pm - 4:25pm	Smith, L	60-1511
41998	W	1:15pm - 4:25pm	Lackey, H	60-1511
43392	Th	1:15pm - 4:25pm	Ellaboudy, A	60-1511
43393	W	6:30pm - 9:40pm	STAFF	60-1511
43394	Th	6:30pm - 9:40pm	STAFF	60-1511

PARALEGAL

■ PLGL 30 — Introduction to Paralegal/Legal 3.0 Units

Degree Applicable, CSU

Prerequisite: Eligibility for ENGL 1A

Federal and state legal systems, role of paralegals and attorneys, legal writing, civil litigation, and legal ethics.

40957	MW	11:30am - 12:55pm	Mc Kee, C	78-3120
40958	T	7:00pm - 10:10pm	Paige, L	78-3120

■ PLGL 31B — Advanced Legal Analysis and Writing 3.0 Units

Degree Applicable, CSU

Prerequisite: PLGL 30 and PLGL 31A

Preparation of research memoranda, briefs, and other paralegal documents. Westlaw and Lexis-Nexis.

40959	MW	9:45am - 11:10am	Mc Kee, C	78-2105
-------	----	------------------	-----------	---------

NOTE: Initial registration in CRN 40959 is reserved for students enrolled in the PLGL cohort program through Wednesday, January 31. Cohort students should contact Professor Catherine McKee at cmckee@mtsac.edu prior to registering for the class. Beginning February 1, all other students meeting the course co-/pre-requisites may register for this section. Alternatively, non-cohort students may register for CRN 41247.

41247	MW	9:45am - 11:10am	Mc Kee, C	78-2105
-------	----	------------------	-----------	---------

40960	M	7:00pm - 10:10pm	Bladh, E	78-2105
-------	---	------------------	----------	---------

NOTE: Initial registration in CRN 40960 is reserved for students enrolled in the PLGL cohort program through Wednesday, January 31. Cohort students should contact Professor Catherine McKee at cmckee@mtsac.edu prior to registering for the class. Beginning February 1, all other students meeting the course co-/pre-requisites may register for this section. Alternatively, non-cohort students may register for CRN 441248.

41248	M	7:00pm - 10:10pm	Bladh, E	78-2105
-------	---	------------------	----------	---------

■ PLGL 33B — Civil Procedure II 3.0 Units

Degree Applicable, CSU

Prerequisite: PLGL 33A

Preparing for litigation. Includes discovery, law and motion, remedies, summary judgments, settlements, and arbitration.

40961	MW	11:30am - 12:55pm	Bladh, E	78-2105
-------	----	-------------------	----------	---------

NOTE: Initial registration in CRN 40961 is reserved for students enrolled in the PLGL cohort program through Wednesday, January 31. Cohort students should contact Professor Catherine McKee at cmckee@mtsac.edu prior to registering for the class. Beginning February 1, all other students meeting the course co-/pre-requisites may register for this section. Alternatively, non-cohort students may register for CRN 41249

41249	MW	11:30am - 12:55pm	Bladh, E	78-2105
-------	----	-------------------	----------	---------

41174	W	7:00pm - 10:10pm	Bladh, E	78-2105
-------	---	------------------	----------	---------

NOTE: Initial registration in CRN 41174 is reserved for students enrolled in the PLGL cohort program through Wednesday, January 31. Cohort students should contact Professor Catherine McKee at cmckee@mtsac.edu prior to registering for the class. Beginning February 1, all other students meeting the course co-/pre-requisites may register for this section. Alternatively, non-cohort students may register for CRN 41250.

41250	W	7:00pm - 10:10pm	Bladh, E	78-2105
-------	---	------------------	----------	---------

■ PLGL 35B — Law Office Technology 3.0 Units

Degree Applicable

Prerequisite: PLGL 30 and PLGL 35A*Advisory:* CISB 15

Use of the computer in the law office; includes drafting of documents, billing, case management, and e-discovery.

40962	MW	1:15pm - 2:40pm	Bladh, E	78-2105
-------	----	-----------------	----------	---------

NOTE: Initial registration in CRN 40962 is reserved for students enrolled in the PLGL cohort program through Wednesday, January 31. Cohort students should contact Professor Catherine McKee at cmckee@mtsac.edu prior to registering for the class. Beginning February 1, all other students meeting the course co-/pre-requisites may register for this section. Alternatively, non-cohort students may register for CRN 41251.

41251	MW	1:15pm - 2:40pm	Bladh, E	78-2105
-------	----	-----------------	----------	---------

40963	T	7:00pm - 10:10pm	Bladh, E	78-2105
-------	---	------------------	----------	---------

NOTE: Initial registration in CRN 40963 is reserved for students enrolled in the PLGL cohort program through Wednesday, January 31. Cohort students should contact Professor Catherine McKee at cmckee@mtsac.edu prior to registering for the class. Beginning February 1, all other students meeting the course co-/pre-requisites may register for this section. Alternatively, non-cohort students may register for CRN 41252.

41252	T	7:00pm - 10:10pm	Bladh, E	78-2105
-------	---	------------------	----------	---------

■ PLGL 36 — Paralegal Internship**1.0 Unit**
Degree Applicable

(May be taken for Pass/No Pass Only)

*Prerequisite: PLGL 31A, PLGL 33A, and PLGL 35A**Corequisite: PLGL 31B, PLGL 33B, PLGL 35B, PLGL 37, PLGL 39 (may have been taken previously)*

On-the-job experience in the paralegal profession. Placement is not guaranteed. 75 paid or 60 non-paid clock hours is required.

40964 arrange 4.7 hours Wood, A OCAM

NOTE: CRN 40964 Provides the student with on-the-job experience in an approved work site. A minimum of 75 paid hours or 60 non-paid hours per term is required for each unit of credit. Work experience placement is not guaranteed. Student must contact Career Services Specialist, Dawn Finley at dfinley@mtsac.edu by January 22, 2018**■ PLGL 37 — Tort Law****3.0 Units**
Degree Applicable, CSU

Analysis of law of torts, including intentional torts, negligence, and strict liability. Examination of insurance defense issues.

40965 TTh 5:15pm - 6:40pm Durfield, T 78-3180

■ PLGL 38 — Employment and Ethical Issues in Paralegalism**2.0 Units**
Degree Applicable*Prerequisite: PLGL 31A, PLGL 33A, and PLGL 35A**Corequisite: PLGL 31B, PLGL 33B, PLGL 35B, PLGL 37, PLGL 39 (may have been taken previously)*

Job search skills including preparation of resumes and cover letters, interviewing, networking, and paralegal and attorney ethics.

41227 T 4:00pm - 6:05pm Mc Kee, C 78-2105

40966 Th 7:30pm - 9:35pm Lahr-Dolgovin, R 78-3100

■ PLGL 39 — Contract Law**3.0 Units**
Degree Applicable, CSU

Laws relating to the formation of contracts, the statute of frauds, third-party rights, breach of contract, remedies and discharge

40967 TTh 8:00am - 9:25am Wood, A 78-2105

■ PLGL 41 — Property Law**3.0 Units**
Degree Applicable, CSU

Examination of the law relating to real and personal property.

40968 M 7:00pm - 10:10pm Estes, E 77-2070

■ PLGL 42 — Family Law**3.0 Units**
Degree Applicable, CSU

Laws relating to marriage, dissolution, nullity, and legal separation.

40969 T 7:00pm - 10:10pm Lahr-Dolgovin, R 78-3100

■ PLGL 43 — Wills and Trusts**3.0 Units**
Degree Applicable, CSU

Legal principles of wills and trusts, jurisdiction of the California Probate Courts, estate planning, and estate taxes.

40970 Th 7:00pm - 10:10pm Rabun, T 18-15

■ PLGL 49 — Evidence Law**3.0 Units**
Degree Applicable, CSU

Evidence law in civil and criminal cases, burdens of proof and presumptions as well as constitutional issues.

40971 M 7:00pm - 10:10pm STAFF 18-15

PHILOSOPHY**■ PHIL 3 — Introduction to Logic****3.0 Units**
Degree Applicable, CSU, UC*Prerequisite: Eligibility for ENGL 68*

Analysis of language as an instrument of sound thinking in morals, politics and everyday life.

42380 TTh 9:45am - 11:10am Wolde-Yohannes, S 26D-2230

42381 MW 11:30am - 12:55pm Mc Gruder, C 26D-2240

42586 TTh 1:15pm - 2:40pm Wolde-Yohannes, S 26D-2240

42460 arrange 6.75 hours Mc Gruder, C ONLINE

8 Weeks, Week beginning 02/26/2018 ending 04/22/2018**NOTE: CRN 42460** is a Distance Learning Online Class.**How to Begin Course:** Log into Canvas through <http://myportal.mtsac.edu> and click on CRN for your DL course. **NOTE:** Some courses may not be activated until the start of the term. If you cannot locate your DL course in Canvas when the term starts, contact the professor. **On the first day of classes, log into your DL course to show your "attendance" because not doing so could result in your being dropped from the class for non-attendance.****Professor contact info:** Please visit the course website at <http://instruction.mtsac.edu/cmcruder> or you can email Professor Mc Gruder at either: CMcGruder@mtsac.edu, through Student Detail Schedule or Canvas at MyMtSAC Portal.**Students must use their Mt. SAC e-mail account and be aware of course commitment and student expectations described at <http://www.mtsac.edu/instruction/learning/distlearn/>**To prepare for a successful online learning experience, see helpful short videos at <http://www.mtsac.edu/distancelearning/quiz/>

42461 arrange 6.75 hours Mc Gruder, C ONLINE

8 Weeks, Week beginning 02/26/2018 ending 04/22/2018**NOTE: CRN 42461** is a Distance Learning Online Class.**How to Begin Course:** Log into Canvas through <http://myportal.mtsac.edu> and click on CRN for your DL course. **NOTE:** Some courses may not be activated until the start of the term. If you cannot locate your DL course in Canvas when the term starts, contact the professor. **On the first day of classes, log into your DL course to show your "attendance" because not doing so could result in your being dropped from the class for non-attendance.****Professor contact info:** Please visit the course website at <http://instruction.mtsac.edu/cmcruder> or you can email Professor Mc Gruder at either: CMcGruder@mtsac.edu, through Student Detail Schedule or Canvas at MyMtSAC Portal.**Students must use their Mt. SAC e-mail account and be aware of course commitment and student expectations described at <http://www.mtsac.edu/instruction/learning/distlearn/>**To prepare for a successful online learning experience, see helpful short videos at <http://www.mtsac.edu/distancelearning/quiz/>

42615 arrange 6.75 hours Mc Gruder, C ONLINE

8 Weeks, Week beginning 02/26/2018 ending 04/22/2018**NOTE: CRN 42615** is a Distance Learning Online Class.**How to Begin Course:** Log into Canvas through <http://myportal.mtsac.edu> and click on CRN for your DL course. **NOTE:** Some courses may not be activated until the start of the term. If you cannot locate your DL course in Canvas when the term starts, contact the professor. **On the first day of classes, log into your DL course to show your "attendance" because not doing so could result in your being dropped from the class for non-attendance.****Professor contact info:** Please visit the course website at <http://instruction.mtsac.edu/cmcruder> or you can email Professor Mc Gruder at either: CMcGruder@mtsac.edu, through Student Detail Schedule or Canvas at MyMtSAC Portal.**Students must use their Mt. SAC e-mail account and be aware of course commitment and student expectations described at <http://www.mtsac.edu/instruction/learning/distlearn/>**To prepare for a successful online learning experience, see helpful short videos at <http://www.mtsac.edu/distancelearning/quiz/>

■ **PHIL 3H — Introduction to Logic - Honors** **3.0 Units**
Degree Applicable, CSU, UC
Prerequisite: Acceptance into the Honors Program
An honors course is designed to provide an enriched experience. May not receive credit for both PHIL 3 and PHIL 3H.
44150 MW 9:45am - 11:10am Mc Gruder, C 26D-2240

■ **PHIL 5 — Introduction to Philosophy** **3.0 Units**
(C-ID PHIL 100) Degree Applicable, CSU, UC

Prerequisite: Eligibility for ENGL 68
Philosophical ideas concerning knowledge, reality, and values.
42382 MW 8:00am - 9:25am Merward III, C 26A-3630
NOTE: No cost digital textbooks or textual materials used.
42383 TTh 8:00am - 9:25am Komrosky, J 18-17
42384 MW 9:45am - 11:10am Haney, R 26A-2690
42385 TTh 9:45am - 11:10am Kostiuk, E 26A-3630
44153 TTh 9:45am - 11:10am Komrosky, J 18-17
42386 MW 11:30am - 12:55pm Haney, R 26A-2690
42387 TTh 11:30am - 12:55pm Kostiuk, E 26A-3630
42388 TTh 11:30am - 12:55pm Tonini, G 211-1
42389 TTh 1:15pm - 2:40pm Tonini, G 211-1
42390 M 3:30pm - 6:40pm Lane, D 26D-2431

NOTE: No cost digital textbooks or textual materials used.
43033 T 7:00pm - 10:10pm Lane, D 26D-2431

NOTE: No cost digital textbooks or textual materials used.
42462 arrange 6.75 hours Lane, D ONLINE
8 Weeks, Week beginning 02/26/2018 ending 04/22/2018

NOTE: CRN 42462 is a Distance Learning Online Class.
How to Begin Course: Log into Canvas through <http://myportal.mtsac.edu> and click on CRN for your DL course. **NOTE:** Some courses may not be activated until the start of the term. If you cannot locate your DL course in Canvas when the term starts, contact the professor. **On the first day of classes, log into your DL course to show your "attendance" because not doing so could result in your being dropped from the class for non-attendance.**

Professor contact info: Email Professor Lane at either: DLane@mtsac.edu, through Student Detail Schedule or Canvas at MyMtSAC Portal.

Students must use their Mt. SAC e-mail account and be aware of course commitment and student expectations described at <http://www.mtsac.edu/instruction/learning/distlearn/>

To prepare for a successful online learning experience, see helpful short videos at <http://www.mtsac.edu/distancelearning/quiz/>

No cost digital textbooks or textual materials used.

42463 arrange 6.75 hours Wolde-Yohannes, S ONLINE
8 Weeks, Week beginning 02/26/2018 ending 04/22/2018

NOTE: CRN 42463 is a Distance Learning Online Class.

How to Begin Course: Log into Canvas through <http://myportal.mtsac.edu> and click on CRN for your DL course. **NOTE:** Some courses may not be activated until the start of the term. If you cannot locate your DL course in Canvas when the term starts, contact the professor. **On the first day of classes, log into your DL course to show your "attendance" because not doing so could result in your being dropped from the class for non-attendance.**

Professor contact info: Email Professor Wolde-Yohannes at either: SWoldeYohannes@mtsac.edu, through Student Detail Schedule or Canvas at MyMtSAC Portal.

Students must use their Mt. SAC e-mail account and be aware of course commitment and student expectations described at <http://www.mtsac.edu/instruction/learning/distlearn/>

To prepare for a successful online learning experience, see helpful short videos at <http://www.mtsac.edu/distancelearning/quiz/>

42480 arrange 6.75 hours Lane, D ONLINE
8 Weeks, Week beginning 04/23/2018 ending 06/17/2018

NOTE: CRN 42480 is a Distance Learning Online Class.

How to Begin Course: Log into Canvas through <http://myportal.mtsac.edu> and click on CRN for your DL course. **NOTE:** Some courses may not be activated until the start of the term. If you cannot locate your DL course in Canvas when the term starts, contact the professor. **On the first day of classes, log into your DL course to show your "attendance" because not doing so could result in your being dropped from the class for non-attendance.**

Professor contact info: Email Professor Lane at either: DLane@mtsac.edu, through Student Detail Schedule or Canvas at MyMtSAC Portal.

Students must use their Mt. SAC e-mail account and be aware of course commitment and student expectations described at <http://www.mtsac.edu/instruction/learning/distlearn/>

To prepare for a successful online learning experience, see helpful short videos at <http://www.mtsac.edu/distancelearning/quiz/>

No cost digital textbooks or textual materials used.

42885 arrange 6.75 hours Wolde-Yohannes, S ONLINE
8 Weeks, Week beginning 04/23/2018 ending 06/17/2018

NOTE: CRN 42885 is a Distance Learning Online Class.

How to Begin Course: Log into Canvas through <http://myportal.mtsac.edu> and click on CRN for your DL course. **NOTE:** Some courses may not be activated until the start of the term. If you cannot locate your DL course in Canvas when the term starts, contact the professor. **On the first day of classes, log into your DL course to show your "attendance" because not doing so could result in your being dropped from the class for non-attendance.**

Professor contact info: Email Professor Wolde-Yohannes at either: SWoldeYohannes@mtsac.edu, through Student Detail Schedule or Canvas at MyMtSAC Portal.

Students must use their Mt. SAC e-mail account and be aware of course commitment and student expectations described at <http://www.mtsac.edu/instruction/learning/distlearn/>

To prepare for a successful online learning experience, see helpful short videos at <http://www.mtsac.edu/distancelearning/quiz/>

42886 arrange 6.75 hours Henry, D ONLINE
8 Weeks, Week beginning 04/23/2018 ending 06/17/2018

NOTE: CRN 42886 is a Distance Learning Online Class.

How to Begin Course: Log into Canvas through <http://myportal.mtsac.edu> and click on CRN for your DL course. **NOTE:** Some courses may not be activated until the start of the term. If you cannot locate your DL course in Canvas when the term starts, contact the professor. **On the first day of classes, log into your DL course to show your "attendance" because not doing so could result in your being dropped from the class for non-attendance.**

Professor contact info: Email Professor Henry at either: DHenry@mtsac.edu, through Student Detail Schedule or Canvas at MyMtSAC Portal.

Students must use their Mt. SAC e-mail account and be aware of course commitment and student expectations described at <http://www.mtsac.edu/instruction/learning/distlearn/>

To prepare for a successful online learning experience, see helpful short videos at <http://www.mtsac.edu/distancelearning/quiz/>

43074 arrange 6.75 hours Park, J ONLINE
8 Weeks, Week beginning 04/23/2018 ending 06/17/2018

NOTE: CRN 43074 is a Distance Learning Online Class.

How to Begin Course: Log into Canvas through <http://myportal.mtsac.edu> and click on CRN for your DL course. **NOTE:** Some courses may not be activated until the start of the term. If you cannot locate your DL course in Canvas when the term starts, contact the professor. **On the first day of classes, log into your DL course to show your "attendance" because not doing so could result in your being dropped from the class for non-attendance.**

Professor contact info: Email Professor Park at either: JSPark@mtsac.edu, through Student Detail Schedule or Canvas at MyMtSAC Portal.

Students must use their Mt. SAC e-mail account and be aware of course commitment and student expectations described at <http://www.mtsac.edu/instruction/learning/distlearn/>

To prepare for a successful online learning experience, see helpful short videos at <http://www.mtsac.edu/distancelearning/quiz/>

44163 arrange 6.75 hours Ramal, R ONLINE

8 Weeks, Week beginning 04/23/2018 ending 06/17/2018**NOTE:** CRN 44163 is a Distance Learning Online Class.

How to Begin Course: Log into Canvas through <http://myportal.mtsac.edu> and click on CRN for your DL course. **NOTE:** Some courses may not be activated until the start of the term. If you cannot locate your DL course in Canvas when the term starts, contact the professor. **On the first day of classes, log into your DL course to show your "attendance" because not doing so could result in your being dropped from the class for non-attendance.**

Professor contact info: Email Professor Ramal at either: RRamal@mtsac.edu, through Student Detail Schedule or Canvas at MyMtSAC Portal.

Students must use their Mt. SAC e-mail account and be aware of course commitment and student expectations described at <http://www.mtsac.edu/instruction/learning/distlearn/>

To prepare for a successful online learning experience, see helpful short videos at <http://www.mtsac.edu/distancelearning/quiz/>

PHIL 8 — Critical Thinking 3.0 Units

Degree Applicable, CSU, UC

Effective use of critical thinking in contemporary living, including recognizing faulty arguments and avoiding common fallacies.

42391 MW 9:45am - 11:10am Merward III, C 26A-3630

NOTE: No cost digital textbooks or textual materials used.

42392 MW 1:15pm - 2:40pm Lloyd, A 26A-1690

42393 TTh 1:15pm - 2:40pm Lloyd, A 26A-1690

42394 T 3:30pm - 6:40pm Lane, D 26D-2431

NOTE: No cost digital textbooks or textual materials used.

42587 W 7:00pm - 10:10pm Tircuit, I 26D-2431

42464 arrange 6.75 hours Lane, D ONLINE

8 Weeks, Week beginning 02/26/2018 ending 04/22/2018**NOTE:** CRN 42464 is a Distance Learning Online Class.

How to Begin Course: Log into Canvas through <http://myportal.mtsac.edu> and click on CRN for your DL course. **NOTE:** Some courses may not be activated until the start of the term. If you cannot locate your DL course in Canvas when the term starts, contact the professor. **On the first day of classes, log into your DL course to show your "attendance" because not doing so could result in your being dropped from the class for non-attendance.**

Professor contact info: Email Professor Lane at either: DLane@mtsac.edu, through Student Detail Schedule or Canvas at MyMtSAC Portal.

Students must use their Mt. SAC e-mail account and be aware of course commitment and student expectations described at <http://www.mtsac.edu/instruction/learning/distlearn/>

To prepare for a successful online learning experience, see helpful short videos at <http://www.mtsac.edu/distancelearning/quiz/>

No cost digital textbooks or textual materials used.

42594 arrange 6.75 hours Park, J ONLINE

8 Weeks, Week beginning 04/23/2018 ending 06/17/2018**NOTE:** CRN 42594 is a Distance Learning Online Class.

How to Begin Course: Log into Canvas through <http://myportal.mtsac.edu> and click on CRN for your DL course. **NOTE:** Some courses may not be activated until the start of the term. If you cannot locate your DL course in Canvas when the term starts, contact the professor. **On the first day of classes, log into your DL course to show your "attendance" because not doing so could result in your being dropped from the class for non-attendance.**

Professor contact info: Email Professor Park at either: JSPark@mtsac.edu, through Student Detail Schedule or Canvas at MyMtSAC Portal.

Students must use their Mt. SAC e-mail account and be aware of course commitment and student expectations described at <http://www.mtsac.edu/instruction/learning/distlearn/>

To prepare for a successful online learning experience, see helpful short videos at <http://www.mtsac.edu/distancelearning/quiz/>

PHIL 9 — Critical Thinking and Writing 3.0 Units

Degree Applicable, CSU, UC

Prerequisite: ENGL 1A or ENGL 1AH

Function and use of formal and informal logic, argument, critical evaluation, and language in written composition.

44183 MW 11:30am - 12:55pm Merward III, C 26A-3630

NOTE: No cost digital textbooks or textual materials used.

44182 TTh 11:30am - 12:55pm Grey, G 26D-2230

NOTE: No cost digital textbooks or textual materials used.

42395 MW 1:15pm - 2:40pm Grey, G 26A-3630

NOTE: No cost digital textbooks or textual materials used.

42465 arrange 6.75 hours Stowell, A ONLINE

8 Weeks, Week beginning 02/26/2018 ending 04/22/2018**NOTE:** CRN 42465 is a Distance Learning Online Class.

How to Begin Course: Log into Canvas through <http://myportal.mtsac.edu> and click on CRN for your DL course. **NOTE:** Some courses may not be activated until the start of the term. If you cannot locate your DL course in Canvas when the term starts, contact the professor. **On the first day of classes, log into your DL course to show your "attendance" because not doing so could result in your being dropped from the class for non-attendance.**

Professor contact info: Email Professor Stowell at either: AStowell@mtsac.edu, through Student Detail Schedule or Canvas at MyMtSAC Portal.

Students must use their Mt. SAC e-mail account and be aware of course commitment and student expectations described at <http://www.mtsac.edu/instruction/learning/distlearn/>

To prepare for a successful online learning experience, see helpful short videos at <http://www.mtsac.edu/distancelearning/quiz/>

42887 arrange 6.75 hours Stowell, A ONLINE

8 Weeks, Week beginning 04/23/2018 ending 06/17/2018**NOTE:** CRN 42887 is a Distance Learning Online Class.

How to Begin Course: Log into Canvas through <http://myportal.mtsac.edu> and click on CRN for your DL course. **NOTE:** Some courses may not be activated until the start of the term. If you cannot locate your DL course in Canvas when the term starts, contact the professor. **On the first day of classes, log into your DL course to show your "attendance" because not doing so could result in your being dropped from the class for non-attendance.**

Professor contact info: Email Professor Stowell at either: AStowell@mtsac.edu, through Student Detail Schedule or Canvas at MyMtSAC Portal.

Students must use their Mt. SAC e-mail account and be aware of course commitment and student expectations described at <http://www.mtsac.edu/instruction/learning/distlearn/>

To prepare for a successful online learning experience, see helpful short videos at <http://www.mtsac.edu/distancelearning/quiz/>

44184 arrange 6.75 hours Henry, D ONLINE

8 Weeks, Week beginning 04/23/2018 ending 06/17/2018**NOTE:** CRN 44184 is a Distance Learning Online Class.

How to Begin Course: Log into Canvas through <http://myportal.mtsac.edu> and click on CRN for your DL course. **NOTE:** Some courses may not be activated until the start of the term. If you cannot locate your DL course in Canvas when the term starts, contact the professor. **On the first day of classes, log into your DL course to show your "attendance" because not doing so could result in your being dropped from the class for non-attendance.**

Professor contact info: Email Professor Henry at either: DHenry@mtsac.edu, through Student Detail Schedule or Canvas at MyMtSAC Portal.

Students must use their Mt. SAC e-mail account and be aware of course commitment and student expectations described at <http://www.mtsac.edu/instruction/learning/distlearn/>

To prepare for a successful online learning experience, see helpful short videos at <http://www.mtsac.edu/distancelearning/quiz/>

■ **PHIL 12 — Introduction to Ethics** **3.0 Units**
(C-ID PHIL 120) Degree Applicable, CSU, UC

Prerequisite: Eligibility for ENGL 1A

Concepts of morality and values, representative ethical theories, and applications to moral problems.

42396	MW	8:00am - 9:25am	Alexander, E	26D-2230
42397	TTh	1:15pm - 2:40pm	Lape, E	26A-3630
42466	arrange	6.75 hours	Wolde-Yohannes, S	ONLINE

8 Weeks, Week beginning 04/23/2018 ending 06/17/2018

NOTE: CRN 42466 is a Distance Learning Online Class.

How to Begin Course: Log into Canvas through <http://myportal.mtsac.edu> and click on CRN for your DL course. **NOTE:** Some courses may not be activated until the start of the term. If you cannot locate your DL course in Canvas when the term starts, contact the professor. **On the first day of classes, log into your DL course to show your "attendance" because not doing so could result in your being dropped from the class for non-attendance.**

Professor contact info: Email Professor Wolde-Yohannes at either: SWoldeYohannes@mtsac.edu, through Student Detail Schedule or Canvas at MyMtSAC Portal.

Students must use their Mt. SAC e-mail account and be aware of course commitment and student expectations described at <http://www.mtsac.edu/instruction/learning/distlearn/>

To prepare for a successful online learning experience, see helpful short videos at <http://www.mtsac.edu/distancelearning/quiz/>

42467	arrange	6.75 hours	Diem, A	ONLINE
-------	---------	------------	---------	--------

8 Weeks, Week beginning 02/26/2018 ending 04/22/2018

NOTE: CRN 42467 is a Distance Learning Online Class.

How to Begin Course: Log into Canvas through <http://myportal.mtsac.edu> and click on CRN for your DL course. **NOTE:** Some courses may not be activated until the start of the term. If you cannot locate your DL course in Canvas when the term starts, contact the professor. **On the first day of classes, log into your DL course to show your "attendance" because not doing so could result in your being dropped from the class for non-attendance.**

Professor contact info: Email Professor Diem at either: ADiem@mtsac.edu, through Student Detail Schedule or Canvas at MyMtSAC Portal.

Students must use their Mt. SAC e-mail account and be aware of course commitment and student expectations described at <http://www.mtsac.edu/instruction/learning/distlearn/>

To prepare for a successful online learning experience, see helpful short videos at <http://www.mtsac.edu/distancelearning/quiz/>

No cost digital textbooks or textual materials used.

■ **PHIL 15 — Major World Religions** **3.0 Units**
Degree Applicable, CSU, UC

Prerequisite: Eligibility for ENGL 68

History, doctrines, and practices of the major world religions. Off-campus assignments are required.

42479	MW	9:45am - 11:10am	Park, J	26D-2491
43050	TTh	9:45am - 11:10am	Ramal, R	26A-1690
42468	arrange	6.75 hours	Diem, A	ONLINE

8 Weeks, Week beginning 02/26/2018 ending 04/22/2018

NOTE: CRN 42468 is a Distance Learning Online Class.

How to Begin Course: Log into Canvas through <http://myportal.mtsac.edu> and click on CRN for your DL course. **NOTE:** Some courses may not be activated until the start of the term. If you cannot locate your DL course in Canvas when the term starts, contact the professor. **On the first day of classes, log into your DL course to show your "attendance" because not doing so could result in your being dropped from the class for non-attendance.**

Professor contact info: Email Professor Diem at either: ADiem@mtsac.edu, through Student Detail Schedule or Canvas at MyMtSAC Portal.

Students must use their Mt. SAC e-mail account and be aware of course commitment and student expectations described at <http://www.mtsac.edu/instruction/learning/distlearn/>

To prepare for a successful online learning experience, see helpful short videos at <http://www.mtsac.edu/distancelearning/quiz/>

No cost digital textbooks or textual materials used.

42469	arrange	6.75 hours	Diem, A	ONLINE
-------	---------	------------	---------	--------

8 Weeks, Week beginning 02/26/2018 ending 04/22/2018

NOTE: No cost digital textbooks or textual materials used.

42888	arrange	6.75 hours	Stowell, A	ONLINE
-------	---------	------------	------------	--------

8 Weeks, Week beginning 04/23/2018 ending 06/17/2018

NOTE: CRN 42888 is a Distance Learning Online Class.

How to Begin Course: Log into Canvas through <http://myportal.mtsac.edu> and click on CRN for your DL course. **NOTE:** Some courses may not be activated until the start of the term. If you cannot locate your DL course in Canvas when the term starts, contact the professor. **On the first day of classes, log into your DL course to show your "attendance" because not doing so could result in your being dropped from the class for non-attendance.**

Professor contact info: Email Professor Stowell at either: AStowell@mtsac.edu, through Student Detail Schedule or Canvas at MyMtSAC Portal.

Students must use their Mt. SAC e-mail account and be aware of course commitment and student expectations described at <http://www.mtsac.edu/instruction/learning/distlearn/>

To prepare for a successful online learning experience, see helpful short videos at <http://www.mtsac.edu/distancelearning/quiz/>

■ **PHIL 15H — Major World Religions - Honors** **3.0 Units**
Degree Applicable, CSU, UC

Prerequisite: Acceptance into the Honors Program

An honors course that provides an enriched experience. May not receive credit for both PHIL 15 and PHIL 15H.

44185	TTh	11:30am - 12:55pm	Diem, A	26D-2431
-------	-----	-------------------	---------	----------

NOTE: No cost digital textbooks or textual materials used.

■ **PHIL 20B — History of Modern Philosophy** **3.0 Units**
(C-ID PHIL 140) Degree Applicable, CSU, UC

Prerequisite: Eligibility for ENGL 1A

Major philosophers and philosophical ideas from renaissance to present, with an emphasis on Western philosophy.

42398	TTh	8:00am - 9:25am	Kostiuk, E	26A-3630
-------	-----	-----------------	------------	----------

PHOTOGRAPHY

■ PHOT 1A — Laboratory Studies: Beginning Black and White Photography 1.0 Unit

Degree Applicable

(May be taken for Pass/No Pass Only)

Corequisite: PHOT 10

Extended black-and-white laboratory experiences to improve skills.

43854	T	2:00pm - 5:10pm	Hartman, L	13-1430
43855	Th	3:00pm - 6:10pm	Benoe, C	13-1430
43845	T	6:30pm - 9:40pm	STAFF	13-1430

■ PHOT 1B — Laboratory Studies: Advanced Black and White Photography 1.0 Unit

Degree Applicable

(May be taken for Pass/No Pass Only)

Corequisite: PHOT 11 or PHOT 11A or PHOT 12 or PHOT 17

Extended advanced black and white laboratory experiences.

43857	T	2:00pm - 5:10pm	Hartman, L	13-1430
43858	Th	3:00pm - 6:10pm	Benoe, C	13-1430
43856	T	6:30pm - 9:40pm	STAFF	13-1430

■ PHOT 1C — Laboratory Studies: Studio Photography 1.0 Unit

Degree Applicable

(May be taken for Pass/No Pass Only)

Corequisite: PHOT 11 or PHOT 11A or PHOT 11B or PHOT 14 or PHOT 16 or PHOT 17 or PHOT 18 or PHOT 20 or PHOT 26 or PHOT 28 or PHOT 30

Extended studio photography experiences to supplement those available through the regular program.

43860	T	2:00pm - 5:10pm	Hartman, L	13-1430
43861	Th	3:00pm - 6:10pm	Benoe, C	13-1430
43859	T	6:30pm - 9:40pm	STAFF	13-1430

■ PHOT 1D — Laboratory Studies: Computer Applications in Photography 1.0 Unit

Degree Applicable

(May be taken for Pass/No Pass Only)

Corequisite: PHOT 9 or PHOT 11B or PHOT 19 or PHOT 24 or PHOT 26

Extended computer laboratory experiences to supplement those available in the regular program.

43863	T	2:00pm - 5:10pm	Hartman, L	13-1430
43864	Th	3:00pm - 6:10pm	Benoe, C	13-1430
43862	T	6:30pm - 9:40pm	STAFF	13-1430

■ PHOT 5 — Digital Cameras and Composition 1.0 Unit

Degree Applicable

Use of digital cameras and image editing software. Camera required after first class meeting. Field trip required.

43932	F	03/02 6:00pm - 8:05pm	Schaedel, J	13-1430
	and S	03/03 9:00am - 4:50pm	Schaedel, J	13-1430
	and Su	03/04 9:00am - 4:50pm	Schaedel, J	13-1430
1 Weeks, Week beginning 02/26/2018 ending 03/04/2018				

■ PHOT 9 — Digital Image Editing for Photographers 3.0 Units

Degree Applicable

Image editing software and techniques commonly used in photography.

43869	T	8:00am - 10:05am	Benoe, C	13-2425
	and Th	8:00am - 11:10am	Benoe, C	13-2425

■ PHOT 10 — Basic Digital and Film Photography 3.0 Units

Degree Applicable, CSU, UC

The basic mechanical, optical, and chemical properties of photography, including digital and traditional darkroom techniques.

43870	M	8:00am - 10:05am	Hartman, L	13-1455
	and W	8:00am - 11:10am	Hartman, L	13-1455
43884	M	8:00am - 10:05am	Schenck, S	13-2425
	and W	8:00am - 11:10am	Schenck, S	13-2425
43871	T	8:00am - 10:05am	Hartman, L	13-1455
	and Th	8:00am - 11:10am	Hartman, L	13-1455
43878	F	9:00am - 11:05am	Perez, J	13-1455
	and F	11:15am - 2:25pm	Perez, J	13-1455
43873	M	11:30am - 1:35pm	Hartman, L	13-1455
	and W	11:30am - 2:40pm	Hartman, L	13-1455
43872	T	11:30am - 1:35pm	Perez, J	13-1455
	and Th	11:30am - 2:40pm	Perez, J	13-1455
43882	T	11:30am - 1:35pm	STAFF	13-2460
	and Th	11:30am - 2:40pm	STAFF	13-2460
43876	M	3:00pm - 5:05pm	Schenck, S	13-1455
	and W	3:00pm - 6:10pm	Schenck, S	13-1455
43874	T	3:00pm - 5:05pm	Cook, D	13-1455
	and Th	3:00pm - 6:10pm	Cook, D	13-1455
43879	M	6:30pm - 8:35pm	Mc Cready, L	13-1455
	and W	6:30pm - 9:40pm	Mc Cready, L	13-1455
43877	T	6:30pm - 8:35pm	Edwards, C	13-1455
	and Th	6:30pm - 9:40pm	Edwards, C	13-1455
43881	S	9:00am - 11:05am	Zajack, G	13-1455
	and S	11:15am - 2:25pm	Zajack, G	13-1455

■ PHOT 11A — Intermediate Photography 3.0 Units

Degree Applicable

Prerequisite: PHOT 10

Professional photography techniques and studio lighting.

43885	M	6:30pm - 8:35pm	Loy, J	13-1430
	and W	6:30pm - 9:40pm	Loy, J	13-1430

■ PHOT 11B — Digital Capture Workflow 3.0 Units

Degree Applicable

Prerequisite: PHOT 10

Advisory: PHOT 11A

Advanced application of digital capture workflow using medium and large format digital cameras. Field trips may be required.

43887	T	11:30am - 1:35pm	Benoe, C	13-1430
	and Th	11:30am - 2:40pm	Benoe, C	13-1430

■ PHOT 12 — Photographic Alternatives 3.0 Units

Degree Applicable, CSU, UC

Prerequisite: PHOT 10

Alternative photographic processes.

43867	F	8:00am - 10:05am	Rager, G	13-1430
	and F	10:15am - 1:25pm	Rager, G	13-1430

■ PHOT 14 — Commercial Lighting 3.0 Units

Degree Applicable, CSU

Prerequisite: PHOT 10

Advisory: (PHOT 11 or PHOT 11A) or PHOT 11B

Studio and location lighting techniques for commercial photographic applications. Field trips may be required.

43889	M	8:00am - 10:05am	Perez, J	13-1430
	and W	8:00am - 11:10am	Perez, J	13-1430

■ PHOT 15 — History of Photography 3.0 Units

Degree Applicable, CSU, UC

Prerequisite: Eligibility for ENGL 68

Survey of the history of photography from early 1800s to the present.

Field trip required.

43865	Th	11:30am - 2:40pm	Rager, G	13-1220
43866	W	6:30pm - 9:40pm	Edwards, C	13-1220

PHOT 16 — Fashion and Editorial Portrait Photography **3.0 Units**
Degree Applicable

Prerequisite: PHOT 11 or PHOT 11A
Advisory: PHOT 11B

Studio and location fashion and editorial portrait photography.

43891	M	3:00pm - 5:05pm	STAFF	13-1430
	and W	3:00pm - 6:10pm	STAFF	13-1430

PHOT 18 — Portraiture and Wedding Photography **3.0 Units**
Degree Applicable

Prerequisite: PHOT 10
Advisory: (PHOT 11 or PHOT 11A) and PHOT 11B

Professional studio and field techniques for portrait and wedding photography. Off-campus field trips may be required.

43895	T	3:00pm - 5:05pm	Felix, L	13-2425
	and Th	3:00pm - 6:10pm	Felix, L	13-2425

PHOT 20 — Color Photography **3.0 Units**
Degree Applicable

Prerequisite: PHOT 10

Color principles as they relate to commercial and artistic styles of photography.

43901	M	11:30am - 1:35pm	Benoe, C	13-1430
	and W	11:30am - 2:40pm	Benoe, C	13-1430

PHOT 21 — Exploring Color Photography **3.0 Units**
Degree Applicable

Prerequisite: PHOT 20

Use of color principles as they relate to commercial and artistic styles and innovative use of color applications.

43903	M	11:30am - 1:35pm	Benoe, C	13-1430
	and W	11:30am - 2:40pm	Benoe, C	13-1430

PHOT 24 — Advanced Digital Image Editing for Photographers **3.0 Units**
Degree Applicable

Prerequisite: PHOT 9 and PHOT 10

Advanced digital image editing, archiving, and retouching for photographers.

43905	T	6:30pm - 8:35pm	Clark, H	13-2425
	and Th	6:30pm - 9:40pm	Clark, H	13-2425

PHOT 26 — Video for Photographers **3.0 Units**
Degree Applicable

Prerequisite: (PHOT 11 or PHOT 11A) and PHOT 9
Corequisite: PHOT 14 (may have been taken previously)

Teaches advanced photography students to create moving images for commercial applications with DSLR cameras. Field trips required.

43868	F	8:00am - 10:05am	Benoe, C	13-2425
	and F	10:15am - 1:25pm	Benoe, C	13-2425

PHOT 30 — Advertising Photography **3.0 Units**
Degree Applicable

Prerequisite: (PHOT 11 or PHOT 11A) and PHOT 20
Advisory: PHOT 14

Overview of the commercial photographic industry including specialties and styles. Field trips may be required.

43908	T	8:00am - 10:05am	Perez, J	13-1430
	and Th	8:00am - 11:10am	Perez, J	13-1430

PHYSICAL SCIENCE
PHSC 3 — Energy Science **4.0 Units**
Degree Applicable, CSU, UC

Prerequisite: Eligibility for MATH 100 and Eligibility for ENGL 68

Science of energy production and its impacts on society and the environment. Field trips required.

43955	MW	1:15pm - 2:40pm	Wolf, P	11-2304
	and MW	3:00pm - 4:25pm	Wolf, P	11-2304

PHSC 9 — Physical Science **4.0 Units**
Degree Applicable, CSU, UC

Prerequisite: Eligibility for MATH 71 and Eligibility for ENGL 68

A primarily non-mathematical, conceptual approach to principles of physics and chemistry for non-science majors. Includes lab.

41963	MW	6:30pm - 7:55pm	STAFF	11-2304
	and MW	8:15pm - 9:40pm	STAFF	11-2304

PHYSICS
PHYS 1 — Physics **4.0 Units**
Degree Applicable, CSU, UC

Prerequisite: Eligibility for MATH 100

Discovery of concepts in physics through guided activities in mechanics, electricity, magnetism, and geometrical optics.

41975	MW	8:00am - 9:25am	Anderson, D	60-1503
	and MW	9:45am - 11:10am	Anderson, D	60-1503
44657	MW	5:15pm - 6:40pm	Crogman, H	60-1503
	and MW	7:00pm - 8:25pm	Crogman, H	60-1503

PHYS 2AG — General Physics **4.0 Units**
(C-ID PHYS 105) Degree Applicable, CSU, UC

Prerequisite: MATH 150

Basic principles of physics. Mechanics, heat, fluids, and wave motion.

Includes laboratory.

41930	MW	8:00am - 9:25am	Tatoian, V	60-1620
	and MW	9:45am - 11:10am	Tatoian, V	60-1620
42001	TTh	8:00am - 9:25am	Takemae, S	60-1503
	and TTh	9:45am - 11:10am	Takemae, S	60-1503
41931	TTh	8:00am - 9:25am	Utter, R	60-1620
	and TTh	9:45am - 11:10am	Utter, R	60-1620
42011	MW	12:00pm - 1:25pm	Rickard, M	60-1620
	and MW	1:45pm - 3:10pm	Rickard, M	60-1620
41946	TTh	12:00pm - 1:25pm	Tatoian, V	60-1620
	and TTh	1:45pm - 3:10pm	Tatoian, V	60-1620
41932	MW	1:15pm - 2:40pm	STAFF	60-1503
	and MW	3:00pm - 4:25pm	STAFF	60-1503
41948	TTh	3:30pm - 4:55pm	Han, K	60-1620
	and TTh	5:15pm - 6:40pm	Han, K	60-1620
41979	TTh	3:30pm - 4:55pm	Cheung, M	60-1503
	and TTh	5:15pm - 6:40pm	Cheung, M	60-1503
41950	MW	7:00pm - 8:25pm	STAFF	60-1620
	and MW	8:45pm - 10:10pm	STAFF	60-1503
41947	TTh	7:00pm - 8:25pm	STAFF	60-1503
	and TTh	8:45pm - 10:10pm	STAFF	60-1503
41949	TTh	7:00pm - 8:25pm	Scott, C	60-1620
	and TTh	8:45pm - 10:10pm	Scott, C	60-1620

PHYS 2BG — General Physics **4.0 Units**
(C-ID PHYS 110) Degree Applicable, CSU, UC

Prerequisite: PHYS 2AG or equivalent

Continuation of PHYS 2AG. Includes electricity and magnetism, optics, and modern physics. Includes laboratory.

42002	MW	8:00am - 9:25am	STAFF	11-2304
	and MW	9:45am - 11:10am	STAFF	11-2304
41977	TTh	6:30pm - 7:55pm	Edwards, A	11-2304
	and TTh	8:15pm - 9:40pm	Edwards, A	11-2304

■ PHYS 4A — Engineering Physics **5.0 Units**
 (C-ID PHYS 205) Degree Applicable, CSU, UC

Prerequisite: PHYS 2AG
Corequisite: MATH 181 (May have been taken previously)

Calculus-based course. Studies linear and rotational motion, forces, momentum, work, energy, oscillations, gravitation and waves.

41938	TTh	8:00am - 9:25am	Schnurbusch, K	60-1628
	and TTh	9:45am - 11:50am	Schnurbusch, K	60-1628
41937	MWF	8:30am - 9:45am	Wolf, P	60-1628
	and MWF	10:00am - 11:05am	Wolf, P	60-1628
42007	MW	1:00pm - 3:05pm	STAFF	60-1628
	and MW	3:25pm - 4:50pm	STAFF	60-1628
41967	TTh	1:00pm - 3:05pm	Schnurbusch, K	60-1628
	and TTh	3:30pm - 4:55pm	Schnurbusch, K	60-1628
41951	TTh	6:30pm - 8:35pm	Heyrat, M	60-1628
	and TTh	8:45pm - 10:10pm	Heyrat, M	60-1628

■ PHYS 4B — Engineering Physics **5.0 Units**
 Degree Applicable, CSU, UC

Prerequisite: PHYS 4A
Corequisite: MATH 280 (May have been taken previously)

Calculus-based course covering thermodynamics, electricity and magnetism. Includes laboratory. Continuation of Physics 4A.

41968	TTh	7:30am - 9:35am	Tatoian, V	60-1506
	and TTh	9:55am - 11:20am	Tatoian, V	60-1506
41934	MW	1:00pm - 3:05pm	Schnurbusch, K	60-1506
	and MW	3:25pm - 4:50pm	Schnurbusch, K	60-1506
41935	TTh	6:30pm - 8:35pm	Abachi, S	60-1506
	and TTh	8:45pm - 10:10pm	Abachi, S	60-1506

■ PHYS 4C — Engineering Physics **5.0 Units**
 (C-ID PHYS 215) Degree Applicable, CSU, UC

Prerequisite: PHYS 4B

Calculus-based course covering fluids, sound, electromagnetic waves, relativity, and modern physics.

41936	MW	8:00am - 10:05am	Rickard, M	60-1506
	and MW	10:25am - 11:50am	Rickard, M	60-1506
43952	TTh	1:00pm - 3:05pm	Carter, B	60-1506
	and TTh	3:25pm - 4:50pm	Carter, B	60-1506

■ PHYS 6B — General Physics with Calculus **5.0 Units**
 Degree Applicable, CSU, UC

Prerequisite: PHYS 6A

Calculus level physics course for Life Science majors. Electricity, magnetism, optics, relativity, atomic and nuclear physics.

43957	TTh	8:00am - 10:05am	Rickard, M	11-2304
	and TTh	10:25am - 11:50am	Rickard, M	11-2304

■ PHYS 99 — Special Projects in Physics **2.0 Units**
 Degree Applicable, CSU

Corequisite: PHYS 1 or PHYS 2AG or PHYS 4A (May have been taken previously)

Instructor's authorization needed prior to enrollment. Field trips may be required as part of this course.

41955	TTh	1:00pm - 4:30pm	STAFF	TBA
-------	-----	-----------------	-------	-----

POLITICAL SCIENCE
■ POLI 1 — Introduction to American Government and Politics **3.0 Units**

(C-ID POLS 110) Degree Applicable, CSU, UC

Prerequisite: Eligibility for ENGL 1A

Principles and problems of government with particular emphasis on the national government of the U.S.

42307	MW	8:00am - 9:25am	DePaola, G	26D-G471
42308	MW	8:00am - 9:25am	Khalife, E	26D-G421
44775	TTh	8:00am - 9:25am	Pringle, L	26D-G290
42315	F	8:00am - 11:10am	Trull, S	26D-G210
42316	MW	9:45am - 11:10am	Rivera, K	26D-G290

NOTE: No cost digital textbooks or textual materials used.

42318	MW	9:45am - 11:10am	DePaola, G	26D-G471
42319	MW	9:45am - 11:10am	Simon, C	26D-G411
42322	TTh	9:45am - 11:10am	DePaola, G	26D-G471
42323	MW	11:30am - 12:55pm	Simon, C	26D-G411
42324	MW	11:30am - 12:55pm	Stone, J	26D-G421
42325	MW	11:30am - 12:55pm	Rivera, K	26D-G290

NOTE: No cost digital textbooks or textual materials used.

42327	TTh	11:30am - 12:55pm	Stone, J	26D-G421
42309	F	11:30am - 2:40pm	Trull, S	26D-G210
42328	MW	1:15pm - 2:40pm	Stone, J	26D-G421
42486	TTh	1:15pm - 2:40pm	Stone, J	26D-G421
42568	TTh	1:15pm - 2:40pm	Rivera, K	26D-G290

NOTE: No cost digital textbooks or textual materials used.

42571	MW	3:00pm - 4:25pm	Rivera, K	26D-G290
-------	----	-----------------	-----------	----------

NOTE: No cost digital textbooks or textual materials used.

42313	TTh	3:00pm - 4:25pm	Ross, L	26D-G210
42577	TTh	3:00pm - 4:25pm	Lawton, J	26D-G290
42572	MW	4:45pm - 6:10pm	Gonzalez, R	26D-G290
42600	M	6:30pm - 9:40pm	Trull, S	26D-G210
42904	T	6:30pm - 9:40pm	Trull, S	26D-G210
42905	W	6:30pm - 9:40pm	Trull, S	26D-G210
44279	Th	6:30pm - 9:40pm	Trull, S	26D-G210

■ POLI 1H — Introduction to American Government and Politics - Honors **3.0 Units**

(C-ID POLS 110) Degree Applicable, CSU, UC

Prerequisite: Acceptance into the Honors Program

An honors course designed to provide an enriched experience. May not receive credit for both POLI 1 and POLI 1H.

42378	TTh	9:45am - 11:10am	Rivera, K	26D-G290
-------	-----	------------------	-----------	----------

NOTE: No cost digital textbooks or textual materials used.
■ POLI 2 — Comparative Politics **3.0 Units**
 (C-ID POLS 130) Degree Applicable, CSU, UC

Prerequisite: POLI 1 or POLI 1H
Advisory: Eligibility for ENGL 1A

Comparative analysis of different political systems, institutions, processes, policies and histories.

42329	MW	1:15pm - 2:40pm	Simon, C	26D-G411
-------	----	-----------------	----------	----------

■ POLI 7 — Political Theory II - Early Modern to Contemporary **3.0 Units**

Degree Applicable, CSU, UC

Prerequisite: Eligibility for ENGL 1A
Advisory: POLI 5

Major political philosophers and theories from the late nineteenth century to the present.

42330	MW	9:45am - 11:10am	Stone, J	26D-G421
-------	----	------------------	----------	----------

■ POLI 9 — Introduction to International Relations **3.0 Units**
 (C-ID POLS 140) Degree Applicable, CSU, UC

Prerequisite: Eligibility for ENGL 68

Historical and political background of world politics and core international relations theories and concepts.

42331	TTh	9:45am - 11:10am	Simon, C	26D-G411
42332	TTh	1:15pm - 2:40pm	Simon, C	26D-G411

■ **POLI 10 — Environmental Politics** **3.0 Units**
Degree Applicable, CSU, UC
Advisory: Eligibility for ENGL 1A AND POLI 1 or POLI 1H
Global environmental problems and analysis of political theories and comparative environmental policies.
42590 TTh 9:45am - 11:10am Stone, J 26D-G421

■ **POLI 25 — Latino Politics in the United States** **3.0 Units**
Degree Applicable, CSU, UC
Prerequisite: Eligibility for ENGL 1A
Latino political thought and action and how it is influenced and shaped by American institutions.
42333 TTh 8:00am - 9:25am Madrid, R 26D-G210
42335 TTh 9:45am - 11:10am Madrid, R 26D-G210
44186 MW 11:30am - 12:55pm Ramos Bernal, N 26D-G210
42334 MW 1:15pm - 2:40pm Ramos Bernal, N 26D-G210

■ **POLI 35 — African American Politics** **3.0 Units**
Degree Applicable, CSU, UC
Prerequisite: Eligibility for ENGL 1A
Methods and strategies employed by African Americans in their quest to gain equal access to American institutions.
42336 MW 1:15pm - 2:40pm Jollevet, F 26A-2690

PSYCHOLOGY

■ **PSYC 1A — Introduction to Psychology** **3.0 Units**
(C-ID PSY 110) Degree Applicable, CSU, UC
Prerequisite: Eligibility for ENGL 1A
Advisory: Eligibility for READ 100 or completion of AMLA 33R
Psychological approaches to the study of behavior and mental processes.

42497 MW 6:20am - 7:45am Laub, K 26A-2670
42498 MW 8:00am - 9:25am Chhun, S 26A-2670
42501 MW 8:00am - 9:25am Couch, A 26A-2891
42499 TTh 8:00am - 9:25am Couch, A 26A-2891
42500 TTh 8:00am - 9:25am Li, Q 26A-2670
42502 MW 9:45am - 11:10am Nolan Marion, M 26A-2891
42503 MW 9:45am - 11:10am Seligman, R 26A-2670
NOTE: No cost digital textbooks or textual materials used.
42504 TTh 9:45am - 11:10am Li, Q 26A-2670
42505 TTh 9:45am - 11:10am Willis, J 26A-2891
42506 MW 11:30am - 12:55pm Nolan Marion, M 26A-2891
43064 MW 11:30am - 12:55pm Beakes, J 26A-2670
42507 TTh 11:30am - 12:55pm Melkonian, A 26A-2670
42508 TTh 11:30am - 12:55pm Joneja, K 26A-2891
42511 MW 1:15pm - 2:40pm Chhun, S 26A-2670
42512 MW 1:15pm - 2:40pm Thomas, B 26A-2891
42510 TTh 1:15pm - 2:40pm Joneja, K 26A-2891
43065 TTh 1:15pm - 2:40pm Powell, C 26A-2670
42545 M 3:00pm - 6:10pm Knapp, J 26A-2670
42509 TTh 3:00pm - 4:25pm Joneja, K 26A-2891
44193 TTh 3:00pm - 4:25pm Ingersoll, B 26A-2670
42544 W 3:00pm - 6:10pm Berbiar, E 26A-2670
42548 TTh 4:45pm - 6:10pm Lamar, C 26A-2891
42549 MW 5:15pm - 6:40pm Ano, G 26A-2891
42547 M 6:30pm - 9:40pm Knapp, J 26A-2670
42546 MW 7:00pm - 8:25pm Ano, G 26A-2891
42872 T 7:00pm - 10:10pm Takla, R 26A-2670

42550 arrange 3.4 hours Knapp, J ONLINE
NOTE: CRN 42550 is a Distance Learning Online Class.

How to Begin Course: Log into Canvas through <http://myportal.mtsac.edu> and click on CRN for your DL course. **NOTE:** Some courses may not be activated until the start of the term. If you cannot locate your DL course in Canvas when the term starts, contact the professor. **On the first day of classes, log into your DL course to show your "attendance" because not doing so could result in your being dropped from the class for non-attendance.**

Professor contact info: Email Professor Knapp at either: JKnapp@mtsac.edu, through Student Detail Schedule or Canvas at MyMtSAC Portal.

Students must use their Mt. SAC e-mail account and be aware of course commitment and student expectations described at <http://www.mtsac.edu/instruction/learning/distlearn/>

To prepare for a successful online learning experience, see helpful short videos at <http://www.mtsac.edu/distancelearning/quiz/>

42551 arrange 3.4 hours Ano, G ONLINE
NOTE: CRN 42551 is a Distance Learning Online Class.

How to Begin Course: Log into Canvas through <http://myportal.mtsac.edu> and click on CRN for your DL course. **NOTE:** Some courses may not be activated until the start of the term. If you cannot locate your DL course in Canvas when the term starts, contact the professor. **On the first day of classes, log into your DL course to show your "attendance" because not doing so could result in your being dropped from the class for non-attendance.**

Professor contact info: Email Professor Ano at either: GAno@mtsac.edu, through Student Detail Schedule or Canvas at MyMtSAC Portal.

Students must use their Mt. SAC e-mail account and be aware of course commitment and student expectations described at <http://www.mtsac.edu/instruction/learning/distlearn/>

To prepare for a successful online learning experience, see helpful short videos at <http://www.mtsac.edu/distancelearning/quiz/>

42573 arrange 3.4 hours Powell, C ONLINE
NOTE: CRN 42573 is a Distance Learning Online Class.

How to Begin Course: Log into Canvas through <http://myportal.mtsac.edu> and click on CRN for your DL course. **NOTE:** Some courses may not be activated until the start of the term. If you cannot locate your DL course in Canvas when the term starts, contact the professor. **On the first day of classes, log into your DL course to show your "attendance" because not doing so could result in your being dropped from the class for non-attendance.**

Professor contact info: Email Professor Powell at either: CPowell@mtsac.edu, through Student Detail Schedule or Canvas at MyMtSAC Portal.

Students must use their Mt. SAC e-mail account and be aware of course commitment and student expectations described at <http://www.mtsac.edu/instruction/learning/distlearn/>

To prepare for a successful online learning experience, see helpful short videos at <http://www.mtsac.edu/distancelearning/quiz/>

42595 arrange 3.4 hours Louie, C ONLINE
NOTE: CRN 42595 is a Distance Learning Online Class.

How to Begin Course: Log into Canvas through <http://myportal.mtsac.edu> and click on CRN for your DL course. **NOTE:** Some courses may not be activated until the start of the term. If you cannot locate your DL course in Canvas when the term starts, contact the professor. **On the first day of classes, log into your DL course to show your "attendance" because not doing so could result in your being dropped from the class for non-attendance.**

Professor contact info: Email Professor Louie at either: CLouie@mtsac.edu, through Student Detail Schedule or Canvas at MyMtSAC Portal.

Students must use their Mt. SAC e-mail account and be aware of course commitment and student expectations described at <http://www.mtsac.edu/instruction/learning/distlearn/>

To prepare for a successful online learning experience, see helpful short videos at <http://www.mtsac.edu/distancelearning/quiz/>

42596 arrange 3.4 hours Knapp, J ONLINE
NOTE: CRN 42596 is a Distance Learning Online Class.

How to Begin Course: Log into Canvas through <http://myportal.mtsac.edu> and click on CRN for your DL course. **NOTE:** Some courses may not be activated until the start of the term. If you cannot locate your DL course in Canvas when the term starts, contact the professor. **On the first day of classes, log into your DL course to show your "attendance" because not doing so could result in your being dropped from the class for non-attendance.**

Professor contact info: Email Professor Knapp at either: JKnapp@mtsac.edu, through Student Detail Schedule or Canvas at MyMtSAC Portal.

Students must use their Mt. SAC e-mail account and be aware of course commitment and student expectations described at <http://www.mtsac.edu/instruction/learning/distlearn/>

To prepare for a successful online learning experience, see helpful short videos at <http://www.mtsac.edu/distancelearning/quiz/>

43016 arrange 3.4 hours Dowdle, M ONLINE
NOTE: CRN 43016 is a Distance Learning Online Class.

How to Begin Course: Log into Canvas through <http://myportal.mtsac.edu> and click on CRN for your DL course. **NOTE:** Some courses may not be activated until the start of the term. If you cannot locate your DL course in Canvas when the term starts, contact the professor. **On the first day of classes, log into your DL course to show your "attendance" because not doing so could result in your being dropped from the class for non-attendance.**

Professor contact info: Email Professor Dowdle at either: MDowdle@mtsac.edu, through Student Detail Schedule or Canvas at MyMtSAC Portal.

Students must use their Mt. SAC e-mail account and be aware of course commitment and student expectations described at <http://www.mtsac.edu/instruction/learning/distlearn/>

To prepare for a successful online learning experience, see helpful short videos at <http://www.mtsac.edu/distancelearning/quiz/>

43076 arrange 3.4 hours Fell, D ONLINE
NOTE: CRN 43076 is a Distance Learning Online Class.

How to Begin Course: Log into Canvas through <http://myportal.mtsac.edu> and click on CRN for your DL course. **NOTE:** Some courses may not be activated until the start of the term. If you cannot locate your DL course in Canvas when the term starts, contact the professor. **On the first day of classes, log into your DL course to show your "attendance" because not doing so could result in your being dropped from the class for non-attendance.**

Professor contact info: Email Professor Fell at either: DFell@mtsac.edu, through Student Detail Schedule or Canvas at MyMtSAC Portal.

Students must use their Mt. SAC e-mail account and be aware of course commitment and student expectations described at <http://www.mtsac.edu/instruction/learning/distlearn/>

To prepare for a successful online learning experience, see helpful short videos at <http://www.mtsac.edu/distancelearning/quiz/>

44191 arrange 3.4 hours Blacksher, S ONLINE
NOTE: CRN 44191 is a Distance Learning Online Class.

How to Begin Course: Log into Canvas through <http://myportal.mtsac.edu> and click on CRN for your DL course. **NOTE:** Some courses may not be activated until the start of the term. If you cannot locate your DL course in Canvas when the term starts, contact the professor. **On the first day of classes, log into your DL course to show your "attendance" because not doing so could result in your being dropped from the class for non-attendance.**

Professor contact info: Email Professor Blacksher at either: SBlacksher@mtsac.edu, through Student Detail Schedule or Canvas at MyMtSAC Portal.

Students must use their Mt. SAC e-mail account and be aware of course commitment and student expectations described at <http://www.mtsac.edu/instruction/learning/distlearn/>

To prepare for a successful online learning experience, see helpful short videos at <http://www.mtsac.edu/distancelearning/quiz/>

■ **PSYC 1AH — Introduction to Psychology - Honors** **3.0 Units**
 (C-ID PSY 110) Degree Applicable, CSU, UC

Prerequisite: Acceptance into the Honors Program

Advisory: Eligibility for READ 100 or completion of AMLA 33R

Honors course in behavior and mental processes. May not receive credit for both PSYC 1A and PSYC 1AH.

42513 TTh 9:45am - 11:10am Louie, C 26A-2831

■ **PSYC 1B — Biological Psychology** **3.0 Units**
 (C-ID PSY 150) Degree Applicable, CSU, UC

Prerequisite: PSYC 1A or PSYC 1AH

Advisory: Eligibility for ENGL 1A

Biological mechanisms of behavior. Includes evolution and genetics with emphasis on neuronal and synaptic transmission.

42514 MW 8:00am - 9:25am Lucas, H 26A-1690

42515 MW 9:45am - 11:10am Pivonka-Jones, J 26A-2831

42516 MW 11:30am - 12:55pm Pivonka-Jones, J 26A-2831

42622 MW 11:30am - 12:55pm Keo-Trang, Z 26A-2620

42517 TTh 11:30am - 12:55pm Pellitteri, J 26A-2620

42518 TTh 1:15pm - 2:40pm Pellitteri, J 26A-2620

42874 T 7:00pm - 10:10pm Lopez, V 26A-2821

■ **PSYC 3 — Introduction to Research Methods in Psychology** **4.0 Units**
 (C-ID PSY 205B) Degree Applicable, CSU, UC

Prerequisite: PSYC 1A or PSYC 1AH and PSYC 10 or MATH 110 or MATH 110H

Research methods in psychology including observation and design.

42536 M 8:00am - 11:10am Powell, C 26D-3210

and W 8:00am - 11:10am Powell, C 26D-3210

42537 T 8:00am - 11:10am Powell, C 18D-1105

and Th 8:00am - 11:10am Powell, C 18D-1105

42538 T 11:30am - 2:40pm Bacigalupi, S 26D-3210

and Th 11:30am - 2:40pm Bacigalupi, S 26D-3210

42553 M 12:00pm - 3:10pm Blacksher, S 18D-1105

and W 12:00pm - 3:10pm Blacksher, S 18D-1105

42583 T 5:15pm - 8:25pm Lucas, H 26D-3210

and Th 5:15pm - 8:25pm Lucas, H 26D-3210

■ **PSYC 5 — Psychology of Reasoning and Problem Solving** 3.0 Units
Degree Applicable, CSU

Prerequisite: Eligibility for ENGL 68

The components involved in problem solving and reasoning from a psychological perspective.

42542	MW	9:45am - 11:10am	Couch, A	26A-2821
42543	MW	11:30am - 12:55pm	Perry, A	26A-2811
42614	arrange	3.4 hours	Ano, G	ONLINE

NOTE: CRN 42614 is a Distance Learning Online Class.

How to Begin Course: Log into Canvas through <http://myportal.mtsac.edu> and click on CRN for your DL course. **NOTE:** Some courses may not be activated until the start of the term. If you cannot locate your DL course in Canvas when the term starts, contact the professor. **On the first day of classes, log into your DL course to show your "attendance" because not doing so could result in your being dropped from the class for non-attendance.**

Professor contact info: Email Professor Ano at either: GAno@mtsac.edu, through Student Detail Schedule or Canvas at MyMtSAC Portal.

Students must use their Mt. SAC e-mail account and be aware of course commitment and student expectations described at <http://www.mtsac.edu/instruction/learning/distlearn/>

To prepare for a successful online learning experience, see helpful short videos at <http://www.mtsac.edu/distancelearning/quiz/>

42889	arrange	3.4 hours	Fell, D	ONLINE
-------	---------	-----------	---------	--------

NOTE: CRN 42889 is a Distance Learning Online Class.

How to Begin Course: Log into Canvas through <http://myportal.mtsac.edu> and click on CRN for your DL course. **NOTE:** Some courses may not be activated until the start of the term. If you cannot locate your DL course in Canvas when the term starts, contact the professor. **On the first day of classes, log into your DL course to show your "attendance" because not doing so could result in your being dropped from the class for non-attendance.**

Professor contact info: Email Professor Fell at either: DFell@mtsac.edu, through Student Detail Schedule or Canvas at MyMtSAC Portal.

Students must use their Mt. SAC e-mail account and be aware of course commitment and student expectations described at <http://www.mtsac.edu/instruction/learning/distlearn/>

To prepare for a successful online learning experience, see helpful short videos at <http://www.mtsac.edu/distancelearning/quiz/>

■ **PSYC 10 — Statistics for the Behavioral Sciences** 4.0 Units
Degree Applicable, CSU, UC

Prerequisite: PSYC 1A or SOC 1 and eligibility for MATH 110

Statistical principles of the behavioral sciences.

42520	M	8:00am - 11:10am	Blacksher, S	18D-1105
	and W	8:00am - 11:10am	Blacksher, S	18D-1105
42519	T	8:00am - 11:10am	Dowdle, M	26D-3210
	and Th	8:00am - 11:10am	Dowdle, M	26D-3210
42554	M	11:30am - 2:40pm	Dowdle, M	26D-3210
	and W	11:30am - 2:40pm	Dowdle, M	26D-3210
42584	T	11:30am - 2:40pm	Blacksher, S	18D-1105
	and Th	11:30am - 2:40pm	Blacksher, S	18D-1105

■ **PSYC 14 — Developmental Psychology** 3.0 Units
(C-ID PSY 180) Degree Applicable, CSU, UC

Advisory: Eligibility for ENGL 1A

Psychological principles across the lifespan. This course does not fulfill Title 22 requirements for Child Development majors.

42521	MW	8:00am - 9:25am	Shaw, T	26A-2821
42523	MW	8:00am - 9:25am	Laub, K	26A-2811
42522	TTh	8:00am - 9:25am	Sabet, S	26A-2811
44197	MW	9:45am - 11:10am	Li, Q	21H-2
42555	TTh	9:45am - 11:10am	Sabet, S	26A-2811
42562	TTh	9:45am - 11:10am	Keo-Trang, Z	26A-2620
42563	MW	11:30am - 12:55pm	Shaw, T	26A-2821
42564	TTh	11:30am - 12:55pm	Alcala, M	40-121
42574	TTh	11:30am - 12:55pm	Keo-Trang, Z	26D-G411
44280	TTh	1:15pm - 2:40pm	Alcala, M	40-121
42581	MW	3:00pm - 4:25pm	Beakes, J	26A-2821
42580	M	3:00pm - 6:10pm	Fritz, K	26A-2620
42582	T	3:00pm - 6:10pm	Takla, R	26A-2831

42869	M	7:00pm - 10:10pm	Pace, M	26A-2620
44194	arrange	3.4 hours	Bacigalupi, S	ONLINE

NOTE: CRN 44194 is a Distance Learning Online Class.

How to Begin Course: Log into Canvas through <http://myportal.mtsac.edu> and click on CRN for your DL course. **NOTE:** Some courses may not be activated until the start of the term. If you cannot locate your DL course in Canvas when the term starts, contact the professor. **On the first day of classes, log into your DL course to show your "attendance" because not doing so could result in your being dropped from the class for non-attendance.**

Professor contact info: Email Professor Bacigalupi at either: SBacigalupi@mtsac.edu, through Student Detail Schedule or Canvas at MyMtSAC Portal.

Students must use their Mt. SAC e-mail account and be aware of course commitment and student expectations described at <http://www.mtsac.edu/instruction/learning/distlearn/>

To prepare for a successful online learning experience, see helpful short videos at <http://www.mtsac.edu/distancelearning/quiz/>

44195	arrange	6.75 hours	Fell, D	ONLINE
-------	---------	------------	---------	--------

8 Weeks, Week beginning 04/22/2018 ending 06/17/2018

NOTE: CRN 44195 is a Distance Learning Online Class.

How to Begin Course: Log into Canvas through <http://myportal.mtsac.edu> and click on CRN for your DL course. **NOTE:** Some courses may not be activated until the start of the term. If you cannot locate your DL course in Canvas when the term starts, contact the professor. **On the first day of classes, log into your DL course to show your "attendance" because not doing so could result in your being dropped from the class for non-attendance.**

Professor contact info: Email Professor Fell at either: DFell@mtsac.edu, through Student Detail Schedule or Canvas at MyMtSAC Portal.

Students must use their Mt. SAC e-mail account and be aware of course commitment and student expectations described at <http://www.mtsac.edu/instruction/learning/distlearn/>

To prepare for a successful online learning experience, see helpful short videos at <http://www.mtsac.edu/distancelearning/quiz/>

44198	arrange	3.4 hours	Powell, C	ONLINE
-------	---------	-----------	-----------	--------

NOTE: CRN 44198 is a Distance Learning Online Class.

How to Begin Course: Log into Canvas through <http://myportal.mtsac.edu> and click on CRN for your DL course. **NOTE:** Some courses may not be activated until the start of the term. If you cannot locate your DL course in Canvas when the term starts, contact the professor. **On the first day of classes, log into your DL course to show your "attendance" because not doing so could result in your being dropped from the class for non-attendance.**

Professor contact info: Email Professor Powell at either: CPowell@mtsac.edu, through Student Detail Schedule or Canvas at MyMtSAC Portal.

Students must use their Mt. SAC e-mail account and be aware of course commitment and student expectations described at <http://www.mtsac.edu/instruction/learning/distlearn/>

To prepare for a successful online learning experience, see helpful short videos at <http://www.mtsac.edu/distancelearning/quiz/>

44199	arrange	3.4 hours	Sabet, S	ONLINE
-------	---------	-----------	----------	--------

NOTE: CRN 44199 is a Distance Learning Online Class.

How to Begin Course: Log into Canvas through <http://myportal.mtsac.edu> and click on CRN for your DL course. **NOTE:** Some courses may not be activated until the start of the term. If you cannot locate your DL course in Canvas when the term starts, contact the professor. **On the first day of classes, log into your DL course to show your "attendance" because not doing so could result in your being dropped from the class for non-attendance.**

Professor contact info: Email Professor Sabet at either: SSabet@mtsac.edu, through Student Detail Schedule or Canvas at MyMtSAC Portal.

Students must use their Mt. SAC e-mail account and be aware of course commitment and student expectations described at <http://www.mtsac.edu/instruction/learning/distlearn/>

To prepare for a successful online learning experience, see helpful short videos at <http://www.mtsac.edu/distancelearning/quiz/>

■ **PSYC 15 — Introduction to Child Psychology** **3.0 Units**
Degree Applicable, CSU, UC

Prerequisite: Eligibility for ENGL 1A

Children's psychological development, disorders, and therapies. Does not fulfill Title 22 requirement for child development majors.

42524	MW	8:00am - 9:25am	Beakes, J	26A-2620
42565	TTh	11:30am - 12:55pm	Ingersoll, B	26D-G290
42870	MW	1:15pm - 2:40pm	Shaw, T	26A-2821
44200	T	6:30pm - 9:40pm	Pace, M	26A-2831

■ **PSYC 17 — Introduction to Human Services** **3.0 Units**
Degree Applicable, CSU

Advisory: PSYC 1A or PSYC 1AH or SOC 1 or SOC 1H

History, philosophy, and development of human services in the US. Careers and career self-assessment in human services.

42525	MW	9:45am - 11:10am	Laub, K	26A-2811
-------	----	------------------	---------	----------

■ **PSYC 19 — Abnormal Psychology** **3.0 Units**
(C-ID PSY 120) Degree Applicable, CSU, UC

Prerequisite: PSYC 1A or PSYC 1AH

Students will be familiarized with psychological, biological, and sociocultural approaches to understanding abnormal behavior.

42526	MW	8:00am - 9:25am	Perry, A	26A-2831
42527	TTh	11:30am - 12:55pm	Louie, C	26A-2831
42528	MW	1:15pm - 2:40pm	Nolan Marion, M	26A-2811
42529	T	7:00pm - 10:10pm	Berbiar, E	26A-2620
42890	arrange	3.4 hours	Knapp, J	ONLINE

NOTE: CRN 42890 is a Distance Learning Online Class.

How to Begin Course: Log into Canvas through <http://myportal.mtsac.edu> and click on CRN for your DL course. **NOTE:** Some courses may not be activated until the start of the term. If you cannot locate your DL course in Canvas when the term starts, contact the professor. **On the first day of classes, log into your DL course to show your "attendance" because not doing so could result in your being dropped from the class for non-attendance.**

Professor contact info: Email Professor Knapp at either: JKnapp@mtsac.edu, through Student Detail Schedule or Canvas at MyMtSAC Portal.

Students must use their Mt. SAC e-mail account and be aware of course commitment and student expectations described at <http://www.mtsac.edu/instruction/learning/distlearn/>

To prepare for a successful online learning experience, see helpful short videos at <http://www.mtsac.edu/distancelearning/quiz/>

44201	arrange	6.75 hours	Louie, C	ONLINE
8 Weeks, Week beginning 04/23/2018 ending 06/17/2018				

NOTE: CRN 44201 is a Distance Learning Online Class.

How to Begin Course: Log into Canvas through <http://myportal.mtsac.edu> and click on CRN for your DL course. **NOTE:** Some courses may not be activated until the start of the term. If you cannot locate your DL course in Canvas when the term starts, contact the professor. **On the first day of classes, log into your DL course to show your "attendance" because not doing so could result in your being dropped from the class for non-attendance.**

Professor contact info: Email Professor Louie at either: CLouie@mtsac.edu, through Student Detail Schedule or Canvas at MyMtSAC Portal.

Students must use their Mt. SAC e-mail account and be aware of course commitment and student expectations described at <http://www.mtsac.edu/instruction/learning/distlearn/>

To prepare for a successful online learning experience, see helpful short videos at <http://www.mtsac.edu/distancelearning/quiz/>

■ **PSYC 25 — The Psychology of Women** **3.0 Units**
Degree Applicable, CSU, UC

Advisory: PSYC 1A (taken prior or concurrently), and ENGL 1A (taken prior or concurrently)

A biopsychosocial analysis of the role of gender in the experience of women.

44202	TTh	9:45am - 11:10am	Klee, G	26A-2821
42530	TTh	11:30am - 12:55pm	Klee, G	26A-2811
42566	TTh	1:15pm - 2:40pm	Lamar, C	26A-2831

■ **PSYC 26 — Psychology of Sexuality** **3.0 Units**
(C-ID PSY 130) Degree Applicable, CSU, UC

Prerequisite: Eligibility for ENGL 68

Explores the factors involved in establishing and maintaining intimate sexual relationships.

42532	TTh	11:30am - 12:55pm	Martin, G	26A-2821
42534	MW	1:15pm - 2:40pm	Ano, G	26A-2831
44205	TTh	1:15pm - 2:40pm	Martin, G	26A-2821
42531	MW	3:00pm - 4:25pm	Ano, G	26A-2831
42875	W	7:00pm - 10:10pm	Green, B	26A-2620
44203	arrange	3.4 hours	Ano, G	ONLINE

NOTE: CRN 44203 is a Distance Learning Online Class.

How to Begin Course: Log into Canvas through <http://myportal.mtsac.edu> and click on CRN for your DL course. **NOTE:** Some courses may not be activated until the start of the term. If you cannot locate your DL course in Canvas when the term starts, contact the professor. **On the first day of classes, log into your DL course to show your "attendance" because not doing so could result in your being dropped from the class for non-attendance.**

Professor contact info: Email Professor Ano at either: GAno@mtsac.edu, through Student Detail Schedule or Canvas at MyMtSAC Portal.

Students must use their Mt. SAC e-mail account and be aware of course commitment and student expectations described at <http://www.mtsac.edu/instruction/learning/distlearn/>

To prepare for a successful online learning experience, see helpful short videos at <http://www.mtsac.edu/distancelearning/quiz/>

44204	arrange	3.4 hours	Dowdle, M	ONLINE
-------	---------	-----------	-----------	--------

NOTE: CRN 44204 is a Distance Learning Online Class.

How to Begin Course: Log into Canvas through <http://myportal.mtsac.edu> and click on CRN for your DL course. **NOTE:** Some courses may not be activated until the start of the term. If you cannot locate your DL course in Canvas when the term starts, contact the professor. **On the first day of classes, log into your DL course to show your "attendance" because not doing so could result in your being dropped from the class for non-attendance.**

Professor contact info: Email Professor Dowdle at either: MDowdle@mtsac.edu, through Student Detail Schedule or Canvas at MyMtSAC Portal.

Students must use their Mt. SAC e-mail account and be aware of course commitment and student expectations described at <http://www.mtsac.edu/instruction/learning/distlearn/>

To prepare for a successful online learning experience, see helpful short videos at <http://www.mtsac.edu/distancelearning/quiz/>

■ **PSYC 33 — Psychology for Effective Living** **3.0 Units**
(C-ID PSY 115) Degree Applicable, CSU

Emphasizes the comprehension and application of psychological principles to daily life and personal growth.

42539	TTh	8:00am - 9:25am	Willis, J	26A-2821
42540	MW	9:45am - 11:10am	Thomas, B	26A-2620
42567	TTh	1:15pm - 2:40pm	Willis, J	26A-2811

PUBLIC HEALTH

■ PUBH 24 — Introduction to Public Health **3.0 Units**
Degree Applicable, CSU, UC

Prerequisite: Eligibility for ENGL 1A

Organization and function of public health including current and ethical issues.

43687 TTh 1:45pm - 3:10pm Ito Rocha Santana, N 11-2105

■ PUBH 26 — Introduction to Global Public Health **3.0 Units**
Degree Applicable, CSU

Prerequisite: (PUBH 24 or BIOL 24) and (MATH 110 or MATH 110H or PSYC 10)

Advisory: Eligibility for READ 100 or AMLA 33R

Health and disease in terms of global processes and socioeconomic influences. Major communicable and noncommunicable diseases.

43688 TTh 8:00am - 9:25am Ito Rocha Santana, N 11-2105

■ PUBH 29 — Public Health Microbiology **3.0 Units**
Degree Applicable, CSU

Prerequisite: (PUBH 24 or BIOL 24) and (MICR 1 or MICR 22)

Diversity and properties of microbial agents that impact public health.

43689 TTh 9:45am - 11:10am Rexach, C 7-1120

RADIO - TELEVISION

■ R-TV 01 — Introduction to Electronic Media **3.0 Units**
Degree Applicable, CSU

Prerequisite: Eligibility for ENGL 68

History, structure, function, economics, content and evolution of electronic media.

43756 MW 8:00am - 9:25am Smith, D 12-1280

43757 TTh 8:00am - 9:25am Shiff, J 13-2430

43760 MW 9:45am - 11:10am Smith, D 12-1280

43761 TTh 9:45am - 11:10am Trujillo, T 13-2430

43764 W 7:00pm - 10:10pm Trujillo, T 13-2430

■ R-TV 02 — On-Air Personality Development **3.0 Units**
Degree Applicable, CSU

Corequisite: R-TV 01 and R-TV 11A (May have been taken previously)

Development of voice and style for all aspects of broadcasting including DJ, newscaster, voice-over artist, and voice-tracking.

43766 MW 8:00am - 9:25am Pacheco, M 13-2430

■ R-TV 04 — Broadcast News Field Reporting **3.0 Units**
Degree Applicable

Corequisite: R-TV 01, R-TV 05, and R-TV 11A (May have been taken previously)

Techniques used to research and cover news events including working with emergency personnel, interviewing, and story development.

43769 TTh 3:00pm - 4:25pm Trujillo, T 13-2430

■ R-TV 10 — Radio Programming and Producer Techniques **3.0 Units**
Degree Applicable

Programming, management, and producing techniques for various radio station formats such as music, news, talk, and sports.

43771 MW 3:00pm - 4:25pm Shiff, J 13-2430

■ R-TV 11A — Beginning Radio Production **3.0 Units**
Degree Applicable, CSU

Corequisite: R-TV 01 (May have been taken previously)

Operation of radio production equipment, tape-based and digital, for voice, music and sound effects using ProTools technology.

43775 F 8:00am - 11:10am Kilanski, P 13-2430

43776 T 7:00pm - 10:10pm Blunt, J 13-2430

■ R-TV 11B — Advanced Radio Production **3.0 Units**
Degree Applicable, CSU

Prerequisite: R-TV 11A

Techniques in non-linear recording, editing and mixing using Pro Tools technology.

43778 MW 9:45am - 11:10am Kilanski, P 13-2430

■ R-TV 14 — Media Aesthetics **3.0 Units**
Degree Applicable, CSU

Prerequisite: Eligibility for ENGL 1A

Media aesthetics for film and television. Intended for those pursuing a career in film, TV, and related media.

43780 W 1:00pm - 4:10pm Martin, Y 12-1280

■ R-TV 17 — Internet Radio and Podcasting **3.0 Units**
Degree Applicable

Corequisite: R-TV 01 and R-TV 11A (May have been taken previously)

Internet broadcasting and podcasting: programming, announcing, promotions and legal issues on a working Internet radio station.

43782 M 7:00pm - 10:10pm Hulett, P 13-2430

■ R-TV 18 — Introduction to Screenwriting **3.0 Units**
Degree Applicable, CSU

Prerequisite: Eligibility for ENGL 1A

Screenwriting for television and motion picture production. Includes characterization, visualization, structure and form.

43784 MW 9:45am - 11:10am Geagley, B 13-1420

43785 MW 11:30am - 12:55pm Geagley, B 13-1420

■ R-TV 19A — Beginning Video Production **3.0 Units**
Degree Applicable, CSU

(May be taken for option of Letter grade or Pass/NoPass)

Advisory: R-TV 14

Video production using studio, remote multi-camera, and film-style techniques.

43788 TTh 9:45am - 10:50am Smith, D 13-1420

and TTh 11:00am - 12:20pm Smith, D 13-1420

43790 TTh 12:30pm - 1:35pm Smith, D 13-1420

and TTh 1:45pm - 3:05pm Smith, D 13-1420

43791 MW 4:15pm - 5:20pm STAFF 13-1420

and MW 5:30pm - 6:50pm STAFF 13-1420

■ R-TV 19B — Advanced Video Production **3.0 Units**
Degree Applicable, CSU

Prerequisite: R-TV 19A

Video production techniques emphasizing narrative storytelling, film-style aesthetics and production.

43795 MW 1:00pm - 2:05pm Hall, J 13-1420

and MW 2:15pm - 3:35pm Hall, J 13-1420

■ R-TV 20 — Television News Production **3.0 Units**
Degree Applicable

Prerequisite: R-TV 05 or R-TV 19A

TV newscast production using writing, announcing, equipment, graphics, and editing skills both in and out of the studio.

43797 MW 9:45am - 10:50am STAFF 6-173A

and MW 11:00am - 12:20pm STAFF 6-173A

■ R-TV 22 — Editing for Film and Television **3.0 Units**
Degree Applicable, CSU

Aesthetics and use of editing software for film and TV. Previous production experience recommended.

43800 F 10:30am - 1:40pm Hossain, A 13-1420

■ R-TV 24 — American Film History **3.0 Units**
Degree Applicable, CSU

Prerequisite: Eligibility for ENGL 1A

History of American film and filmmakers from 1895 to the present.

43803 M 1:00pm - 4:10pm Geagley, B 12-1280

■ R-TV 29 — Introduction to Audio Production for Film and Television **3.0 Units**
Degree Applicable, CSU

Theory and practice of audio production for radio, television, film and digital recording applications.

43805 T 2:30pm - 5:40pm Asher, J 13-2460

■ **R-TV 35 — Pop Culture in the Media** **3.0 Units**
Degree Applicable
Examines American Pop Culture from the 1920s through the 1990s as reflected in and influenced by radio, TV and film.
43807 TTh 11:30am - 12:55pm Trujillo, T 13-2430

■ **R-TV 41 — Video Engineering** **3.0 Units**
Degree Applicable
Video engineering for television, video assist for film, and other electronic media.
43809 TTh 6:00pm - 7:05pm STAFF 6-173A
and TTh 7:15pm - 8:35pm STAFF 6-173A

■ **R-TV 96A — Campus Radio Station Lab: Studio Procedures and Equipment Operations** **1.0 Unit**
Degree Applicable

Prerequisite: R-TV 01 and R-TV 11A

Operation of college radio stations. Focus on equipment, station procedures, and Federal Communications Commission regulations.
43811 W 11:30am - 2:40pm Trujillo, T 13-2430
43812 Th 7:00pm - 10:10pm Shiff, J 13-2430

■ **R-TV 96B — Campus Radio Station Lab: Disc Jockey and News Anchor/Reporter Skills** **1.0 Unit**
Degree Applicable

Prerequisite: R-TV 96A

Participation in the college radio stations including developing Disc Jockey, News Anchor, and News Reporter skills.
43813 W 11:30am - 2:40pm Trujillo, T 13-2430
43814 Th 7:00pm - 10:10pm Shiff, J 13-2430

■ **R-TV 96C — Campus Radio Station Lab: Hosting and Management Skills** **1.0 Unit**
Degree Applicable

Participation in the college radio stations including individual show creation and execution as well as management skills.
43816 W 11:30am - 2:40pm Trujillo, T 13-2430
43817 Th 7:00pm - 10:10pm Shiff, J 13-2430

■ **R-TV 97A — Radio/Entertainment Industry Seminar** **1.0 Unit**
Degree Applicable

Prerequisite: R-TV 01, R-TV 11A, R-TV 15, and R-TV 96A

Corequisite: R-TV 97B

Discuss and evaluate professionalism and problem-solving techniques in the Radio Broadcasting industry through an internship.
43818 W 5:00pm - 6:05pm Trujillo, T 13-2430

■ **R-TV 97B — Radio/Entertainment Industry Work Experience** **1.0 Unit**
Degree Applicable

Prerequisite: R-TV 01, R-TV 11A, R-TV 15, and R-TV 96A

Corequisite: R-TV 97A

Work experience in the broadcasting field. A minimum of 75 paid clock hours or 60 non-paid hours is required.
43819 arrange 4.7 hours Trujillo, T 13-2430

■ **R-TV 99 — Special Projects in Broadcasting and Entertainment Industry** **3.0 Units**
Degree Applicable

Prerequisite: R-TV 01 and completion of any six R-TV course units.

Offers students the opportunity to explore the discipline in greater depth. Instructor authorization needed prior to enrollment.
43820 arrange 3.4 hours Trujillo, T 13-2456

■ **R-TV 100 — Work Experience in Film and TV** **1.0 Unit**
Degree Applicable

(May be taken for option of Letter grade or Pass/NoPass)

Prerequisite: Completion of 12 units of R-TV courses, from among the following: R-TV 18, 19A, 19B, 20, 21, 22, 23, and 29. Compliance with Work Experience regulations as designated in the College Catalog.

On-the-job experience in the film and television industry. 60 unpaid or 75 paid hours per unit of credit.
43822 arrange 4.7 hours Smith, D 13-1220

■ **R-TV 100 — Work Experience in Film and TV** **2.0 Units**
Degree Applicable

(May be taken for option of Letter grade or Pass/NoPass)

Prerequisite: Completion of 12 units of R-TV courses, from among the following: R-TV 18, 19A, 19B, 20, 21, 22, 23, and 29. Compliance with Work Experience regulations as designated in the College Catalog.

On-the-job experience in the film and television industry. 60 unpaid or 75 paid hours per unit of credit.
43824 arrange 9.4 hours Smith, D 13-1477

■ **R-TV 101 — Work Experience in Broadcast Entertainment** **1.0 Unit**
Degree Applicable

(May be taken for Pass/No Pass Only)

Prerequisite: Completion of R-TV 01 and R-TV 97A and R-TV 97B and any three other R-TV units. Compliance with Work Experience regulations as designated in the College Catalog.

On-the-job experience in the broadcast or entertainment fields. Minimum of 60 unpaid or 75 paid hours of work per unit of credit.
43825 arrange 4.7 hours Trujillo, T 13-2456

■ **R-TV 101 — Work Experience in Broadcast Entertainment** **2.0 Units**
Degree Applicable

(May be taken for Pass/No Pass Only)

Prerequisite: Completion of R-TV 01 and R-TV 97A and R-TV 97B and any three other R-TV units. Compliance with Work Experience regulations as designated in the College Catalog.

On-the-job experience in the broadcast or entertainment fields. Minimum of 60 unpaid or 75 paid hours of work per unit of credit.
43826 arrange 9.4 hours Trujillo, T 13-2456

RADIOLOGIC TECHNOLOGY

■ **RAD 2A — Clinical Experience 2A** **5.0 Units**
Degree Applicable, CSU

(May be taken for Pass/No Pass Only)

Prerequisite: RAD 1B

Corequisite: RAD 62A, RAD 62B, and RAD 62C

Clinical experience in radiology department under the supervision of a licensed radiologic technologist.

41457	TTh	8:00am - 12:05pm	Engisch, P	HOSP
and F		8:00am - 12:05pm	McLaughlin, D	HOSP
and F		12:40pm - 4:30pm	Neel, M	HOSP

■ **RAD 3C — Clinical Experience 3C** **7.5 Units**
Degree Applicable, CSU

(May be taken for Pass/No Pass Only)

Prerequisite: RAD 3B

Clinical experience in radiology department under the supervision of a licensed radiologic technologist.

41458	MW	8:00am - 12:05pm	McLaughlin, D	HOSP
and MW		12:40pm - 4:30pm	Engisch, P	HOSP
and TTh		1:00pm - 5:05pm	Engisch, P	HOSP

■ **RAD 7B — Computed Tomography Clinical Experience 7B** **7.0 Units**
Not Degree Applicable

(May be taken for Pass/No Pass Only)

Prerequisite: RAD 7A and RAD 70

Corequisite: RAD 71 and RAD 72

Continued Computed Tomography clinical experience in the radiology department of affiliated clinical sites.

41555	arrange	23.63 hours	Neel, M	HOSP
-------	---------	-------------	---------	------

■ **RAD 31 — Fluoroscopy and Radiobiology** **4.0 Units**
Degree Applicable

Prerequisite: RAD 62A

Corequisite: RAD 3C

Radiobiology, radiation physics, fluoroscopy equipment, image evaluation, quality control, and patient consideration.

41519	F	9:30am - 2:00pm	Engisch, P	67A-123
-------	---	-----------------	------------	---------

■ RAD 40 — Mammography Principles and Procedures **3.0 Units**
Not Degree Applicable

Corequisite: RAD 3C

Advanced course designed to provide the skills to become California state certified in Mammographic Radiologic Technology

41577 MW 6:00pm - 8:20pm Neel, M 67A-150
12 Weeks, Week beginning 02/26/2018 ending 05/20/2018

■ RAD 62A — Theory of Radiologic Technology **4.0 Units**
Degree Applicable, CSU

Prerequisite: RAD 61A and RAD 1B

Corequisite: RAD 2A, RAD 62B, and RAD 62C

Areas of X-ray production and interaction with matter, principles of imaging, imaging equipment, and radiation protection.

41459 TTh 1:00pm - 3:05pm Engisch, P 67A-123

■ RAD 62B — Radiographic Procedures II **3.0 Units**
Degree Applicable, CSU

Prerequisite: RAD 61A, RAD 61B, RAD 61C

Corequisite: RAD 62A, RAD 62C and RAD 2A

Knowledge base necessary to perform imaging procedures of the vertebral column, bony thorax, cranium, GI and GU systems.

41460 MW 10:30am - 11:55am Chavers, L 67A-123

■ RAD 62C — Radiographic Procedures II Laboratory **1.5 Units**
Degree Applicable, CSU

Prerequisite: RAD 61A, RAD 61B and RAD 61C

Corequisite: RAD 62A, RAD 62B, RAD 2A

Practical application of imaging procedures of spine, bony thorax, cranium, gastrointestinal and genitourinary systems.

41461 M 8:25am - 9:30am Dinglasan, C 67A-117
and M 9:40am - 10:30am Dinglasan, C 67A-117
43580 W 8:25am - 9:30am Dinglasan, C 67A-117
and W 9:40am - 10:30am Dinglasan, C 67A-117
41462 M 12:00pm - 1:05pm Dinglasan, C 67A-117
and M 1:15pm - 2:05pm Dinglasan, C 67A-117
41463 W 12:00pm - 1:05pm Dinglasan, C 67A-117
and W 1:15pm - 2:05pm Dinglasan, C 67A-117

■ RAD 64 — Theory of Radiologic Technology **4.0 Units**
Degree Applicable, CSU

Corequisite: RAD 3C

Analytical review of the radiologic technology core curriculum. Preparation for terminal licensing examinations.

41464 TTh 9:55am - 12:00pm McLaughlin, D 67A-123

■ RAD 71 — Computed Tomography Procedures and Patient Care **3.0 Units**
Not Degree Applicable

Prerequisite: RAD 70

Corequisite: RAD 72 and RAD 7B

Procedures for Computed Tomography imaging of adults and pediatric patients.

41556 W 6:00pm - 9:10pm McLaughlin, D 67A-123

■ RAD 72 — Computed Tomography Physics and Instrumentation **3.0 Units**
Not Degree Applicable

Corequisite: RAD 71 and RAD 7B

Physical principles and instrumentation involved in Computed Tomography.

41557 TTh 6:00pm - 7:25pm Harryman, P 67A-123

READING

PATHWAYS TO READING COMPETENCY

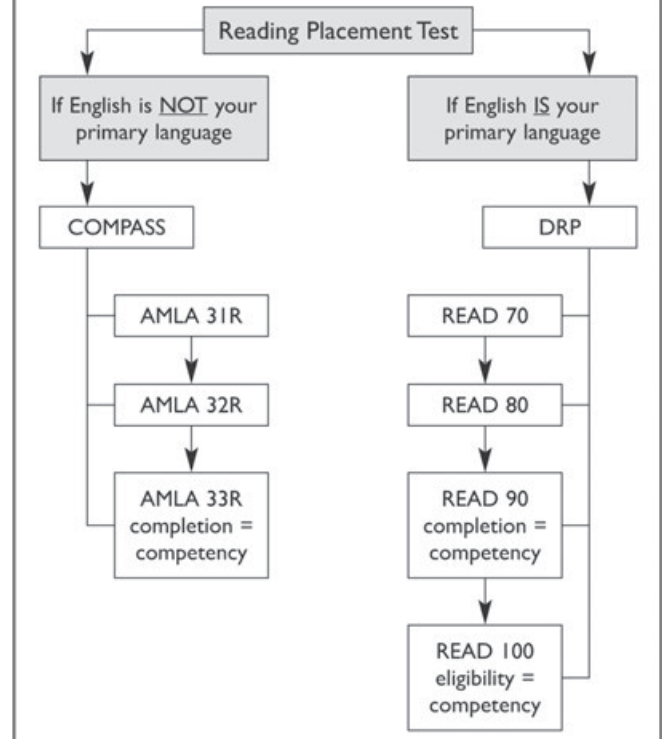

■ READ 70 — Approaches to Reading **3.0 Units**
Not Degree Applicable

(May be taken for Pass/No Pass Only)

Introduction to comprehension and vocabulary strategies, and self-reflection on reading.

43633 MW 3:00pm - 4:25pm Burman, E 6-131

■ READ 80 — Exploring Reading Strategies **3.0 Units**
Not Degree Applicable

(May be taken for Pass/No Pass Only)

Prerequisite: READ 70 or satisfactory score on reading placement test

Reading comprehension, vocabulary strategies, and self-awareness of reading capabilities using narrative and expository text.

43634 TTh 8:00am - 9:25am Gonzales, B 6-136
43635 MW 9:45am - 11:10am Burman, E 6-131
43637 TTh 9:45am - 11:10am Burman, E 6-131
43636 MW 11:30am - 12:55pm Burman, E 6-131
43638 TTh 11:30am - 12:55pm Gonzales, B 6-137

■ READ 90 — Reading College Texts **3.0 Units**
Degree Applicable

(May be taken for option of Letter grade or Pass/NoPass)

Prerequisite: READ 80 or satisfactory score on reading placement test

Effective college textbook reading with an emphasis on vocabulary and cross disciplinary textbook analysis and comprehension.

43641 MW 8:00am - 9:25am Gonzales, B 6-132
43645 MW 8:00am - 9:25am Rowley, D 6-131
43649 TTh 8:00am - 9:25am Rowley, D 6-132
43671 TTh 8:00am - 9:25am Ezzell, S 6-130
43651 F 8:00am - 11:10am Cevallos, S 6-131
43642 MW 9:45am - 11:10am Wheeler, D 6-222
43684 MW 9:45am - 11:10am Gonzales, B 6-132
43650 TTh 9:45am - 11:10am Rowley, D 6-132
43644 MW 11:30am - 12:55pm Gonzales, B 6-136
43678 MW 11:30am - 12:55pm Silva, L 6-222
43647 TTh 11:30am - 12:55pm Silva, L 6-132
43639 MW 1:15pm - 2:40pm Cevallos, S 6-132

43646	TTh	1:15pm - 2:40pm	Martinez, E	6-131
43643	MW	3:00pm - 4:25pm	Gonzales, B	6-132
43663	MW	3:00pm - 4:25pm	Wheeler, D	6-136
43667	TTh	3:00pm - 4:25pm	Silva, L	6-131
43640	MW	4:45pm - 6:10pm	Silva, L	6-132
43648	TTh	4:45pm - 6:10pm	Silva, L	6-131
44147	arrange	3.4 hours	Cevallos, S	ONLINE

NOTE: CRN 44147 is a Distance Learning Online Class.

How to Begin Course: Log into Canvas through the e-Learning Tools tab in the Mt.SAC portal at inside.mtsac.edu. Then click on the Canvas link and then click on CRN for your DL course. **NOTE:** Some courses may not be activated until the start of the term. If you cannot locate your DL course in Canvas when the term starts, contact the professor. **On the first day of classes, log into your DL course to show your "attendance" because not doing so could result in your being dropped from the class for non-attendance.**

Professor contact info: Email Professor Cevallos at either: SCevallos2@mtsac.edu, through Student Detail Schedule or Canvas at MyMt-SAC Portal.

Students must use their Mt.SAC e-mail account and be aware of course commitment and student expectations described at <http://www.mtsac.edu/distancelearning/>

To prepare for a successful online learning experience, see helpful short videos at <http://www.mtsac.edu/distancelearning/quiz/>

43652	S	8:00am - 11:10am	Lowe, J	6-131
-------	---	------------------	---------	-------

■ READ 100 — Analysis and Critical Reading 3.0 Units Degree Applicable, CSU

Prerequisite: READ 90 or satisfactory score on reading placement test

Critical reading course focusing on the effective use of critical thinking in a cross-disciplinary framework.

43679	TTh	8:00am - 9:25am	Cevallos, S	TBA
43655	MW	9:45am - 11:10am	Rowley, D	6
43681	MW	11:30am - 12:55pm	Cevallos, S	TBA
43654	TTh	11:30am - 12:55pm	Cevallos, S	6-222
43653	MW	1:15pm - 2:40pm	Silva, L	6-131
43680	MW	6:30pm - 7:55pm	Gomez-Lecaro, M	6-132
44146	arrange	3.4 hours	Silva, L	ONLINE

NOTE: CRN 44146 is a Distance Learning Online Class.

How to Begin Course: Log into Canvas through the e-Learning Tools tab in the Mt.SAC portal at inside.mtsac.edu. Then click on the Canvas link and then click on CRN for your DL course. **NOTE:** Some courses may not be activated until the start of the term. If you cannot locate your DL course in Canvas when the term starts, contact the professor. **On the first day of classes, log into your DL course to show your "attendance" because not doing so could result in your being dropped from the class for non-attendance.**

Professor contact info: Email Professor Silva at either: LSilva@mtsac.edu, through Student Detail Schedule or Canvas at MyMtSAC Portal.

Students must use their Mt.SAC e-mail account and be aware of course commitment and student expectations described at <http://www.mtsac.edu/distancelearning/>

To prepare for a successful online learning experience, see helpful short videos at <http://www.mtsac.edu/distancelearning/quiz/>

RESPIRATORY THERAPY

■ RESD 51B — Respiratory Therapy Science 4.0 Units Degree Applicable, CSU

Prerequisite: RESD 50 and RESD 51A

Corequisite: RESD 53 and RESD 60

41468	T	12:00pm - 3:10pm	Wiesner, M	67A-138
	and W	9:00am - 12:10pm	Wiesner, M	67A-138
41469	T	12:00pm - 3:10pm	Wiesner, M	67A-138
	and Th	9:00am - 12:10pm	Wiesner, M	67A-138

■ RESD 53 — Cardiopulmonary Pathophysiology 3.0 Units Degree Applicable, CSU

Corequisite: RESD 51B

41470	Th	1:00pm - 4:10pm	Hutchinson, J	67A-138
-------	----	-----------------	---------------	---------

■ RESD 56D — Techniques of Respiratory Therapy 6.0 Units Degree Applicable, CSU

(May be taken for Pass/No Pass Only)

Prerequisite: RESD 56C

Corequisite: RESD 59 and RESD 61

Clinical practice including adult and neonatal intensive care requiring demonstration of all learned clinical skills.

41471	arrange	20.31 hours	Hutchinson, J	HOSP
41472	arrange	20.31 hours	Hutchinson, J	HOSP
41473	arrange	20.31 hours	Hutchinson, J	HOSP

■ RESD 59 — Respiratory Therapeutic Modalities 3.0 Units Degree Applicable, CSU

Prerequisite: RESD 55

Corequisite: RESD 56D and RESD 61

Students are required to purchase self-assessment examinations

41474	M	9:00am - 12:10pm	Coreas, K	67A-138
-------	---	------------------	-----------	---------

■ RESD 60 — Comprehensive Pulmonary Assessment 2.0 Units Degree Applicable, CSU

Corequisite: RESD 51B and RESD 53

41475	W	1:00pm - 3:10pm	Coreas, K	67A-138
-------	---	-----------------	-----------	---------

■ RESD 61 — Current Issues in Respiratory Care 3.0 Units Degree Applicable, CSU

Prerequisite: RESD 56C

Corequisite: RESD 56D and RESD 59

41476	M	1:30pm - 4:40pm	Hutchinson, J	67A-138
-------	---	-----------------	---------------	---------

SIGN LANGUAGE, INTERPRETING

■ SIGN 101 — American Sign Language 1 4.0 Units Degree Applicable, CSU, UC

Fundamentals of American Sign Language including work on comprehension skills and modeling grammatical structures.

42432	MW	7:30am - 9:35am	Pesqueira, D	66-201
42433	TTh	7:30am - 9:35am	Stuard, B	66-201
43066	MW	9:45am - 11:50am	Stuard, B	66-201
42434	TTh	9:45am - 11:50am	Larson, S	66-205
42435	TTh	9:45am - 11:50am	Stuard, B	66-201
42436	MW	12:00pm - 2:05pm	Stuard, E	211-2
42437	MW	12:00pm - 2:05pm	Stuard, B	66-201
42438	MW	2:15pm - 4:20pm	Marin, Y	66-201
43388	TTh	2:15pm - 4:20pm	Larson, S	66-201
42439	MW	4:30pm - 6:35pm	Cienik, M	26A-3630
42440	MW	4:30pm - 6:35pm	Marin, Y	66-246
42441	TTh	4:30pm - 6:35pm	Casale, K	26A-1891
42491	MW	6:45pm - 8:50pm	Safford, M	66-248
42492	TTh	6:45pm - 8:50pm	Casale, K	26A-1891

NOTE: CRN 42492 is a Hybrid Class taught partially online with Scheduled Meetings on Campus.

How to Begin Course: Log into Canvas through <http://myportal.mtsac.edu> and click on CRN for your DL course. **NOTE:** Some courses may not be activated until the start of the term. If you cannot locate your DL course in Canvas when the term starts, contact the professor. **On the first day of classes, log into your DL course to show your "attendance" because not doing so could result in your being dropped from the class for non-attendance.**

Professor contact info: Email Professor Loera-Ramirez at either: DLoera@mtsac.edu, through Student Detail Schedule or Canvas at MyMtSAC Portal.

Students must use their Mt. SAC e-mail account and be aware of course commitment and student expectations described at <http://www.mtsac.edu/instruction/learning/distlearn/>

To prepare for a successful online learning experience, see helpful short videos at <http://www.mtsac.edu/distancelearning/quiz/>

■ SIGN 102 — American Sign Language 2 **4.0 Units**
Degree Applicable, CSU, UC

Prerequisite: SIGN 101 or SIGN 101H

Further study of ASL as well as exposure to Deaf culture. Outside events attendance required.

42442	MW	9:45am - 11:50am	Soza, K	18-15
42443	TTh	9:45am - 11:50am	Dorough, G	19B-9
43389	MW	12:00pm - 2:05pm	Larson, S	21A-2

NOTE: CRN 43389 above is designated for deaf students and linked to SPCH 1A (CRN 42367).

42444	TTh	12:00pm - 2:05pm	Dorough, G	19B-9
42496	TTh	4:30pm - 6:35pm	Larson, S	66-201
42588	MW	6:45pm - 8:50pm	Robles, I	26A-1891

■ SIGN 103 — American Sign Language 3 **4.0 Units**
Degree Applicable, CSU, UC

Prerequisite: SIGN 102

American Sign Language focused on comprehension skills and advanced grammatical structures. Field trips required.

42445	MW	7:30am - 9:35am	Leonard, T	66-205
43043	MW	4:30pm - 6:35pm	Robles, I	26A-1891
43005	MW	6:45pm - 8:50pm	Cienik, M	26A-3630

■ SIGN 104 — American Sign Language 4 **4.0 Units**
Degree Applicable, CSU, UC

Prerequisite: SIGN 103

Expressive and conversational skills in ASL along with continued focus on grammatical and cultural features.

42453	MW	9:45am - 11:50am	Augustus, R	66-205
42454	TTh	6:45pm - 8:50pm	Augustus, R	66-205

■ SIGN 105 — American Sign Language 5 **4.0 Units**
Degree Applicable, CSU

Prerequisite: SIGN 104

Advanced American Sign Language communication skills; emphasis on descriptive narratives and strengthening conversational skills.

42446	MW	12:00pm - 2:05pm	Augustus, R	66-205
-------	----	------------------	-------------	--------

■ SIGN 108 — Fingerspelling **2.0 Units**
Degree Applicable

(May be taken for Pass/No Pass Only)

Prerequisite: SIGN 102

Receptive and expressive fingerspelling.

42447	F	10:00am - 12:05pm	Robles, I	66-201
42448	W	6:45pm - 8:50pm	Marin, Y	66-205

■ SIGN 201 — Introduction to Deaf Studies **3.0 Units**
Degree Applicable, CSU

Topics central to the Deaf community including Deaf education, Deaf/hearing relationships, and Deaf history.

42449	M	6:00pm - 9:10pm	Lubman, M	66-201
-------	---	-----------------	-----------	--------

■ SIGN 202 — American Deaf Culture **3.0 Units**
Degree Applicable, CSU, UC

American Deaf cultural norms, values, mores, and institutions.

42450	T	12:00pm - 3:10pm	Augustus, R	66-205
-------	---	------------------	-------------	--------

■ SIGN 210 — American Sign Language Structure **3.0 Units**
Degree Applicable, CSU, UC

Prerequisite: SIGN 103

Linguistic structure of American Sign Language including phonology, morphology, and syntax, including sociolinguistic issues.

43039	MW	5:15pm - 6:40pm	Moreno, Y	66-209
-------	----	-----------------	-----------	--------

■ SIGN 220 — Translation: American Sign Language And English **4.0 Units**
Degree Applicable, CSU

Prerequisite: SIGN 104

Corequisite: SIGN 210 (May have been taken previously)

American Sign Language (ASL) and English translation by comparing texts and manual narrative in both languages.

42451	TTh	4:30pm - 6:35pm	Augustus, R	66-205
-------	-----	-----------------	-------------	--------

■ SIGN 225 — Ethical Decision Making for Interpreters **2.0 Units**
Degree Applicable

Prerequisite: SIGN 223 and SIGN 231

Development of ethical decision-making skills through the analytical construct of the Demand/Control Schema for interpreting work.

43035	W	4:00pm - 6:05pm	Adamiak, A	26D-G411
-------	---	-----------------	------------	----------

■ SIGN 227 — Cognitive Processing for Interpreters **4.0 Units**
Degree Applicable

(May be taken for option of Letter grade or Pass/NoPass)

Prerequisite: SIGN 104 and ENGL 1A

Corequisite: SIGN 223 (May have been taken previously)

Development of cognitive processing skills necessary for interpreting between ASL and English.

44274	MW and MW	6:15pm - 7:40pm 8:00pm - 9:25pm	Adamiak, A Adamiak, A	26D-G411 26D-G411
-------	--------------	------------------------------------	--------------------------	----------------------

■ SIGN 231 — Interpreting **4.0 Units**
Degree Applicable

(May be taken for option of Letter grade or Pass/NoPass)

Prerequisite: SPCH 1A and SIGN 227

Skill development in consecutive interpreting from American Sign Language (ASL) to English and English to ASL.

42452	TTh and TTh	5:00pm - 6:25pm 6:45pm - 8:10pm	Stephenson, J Stephenson, J	26D-G411 26D-G411
-------	----------------	------------------------------------	--------------------------------	----------------------

■ SIGN 239 — Applied Interpreting **2.0 Units**
Degree Applicable

(May be taken for Pass/No Pass Only)

Prerequisite: SIGN 232

Capstone course in the interpreting program. 40 hours of out-of-class interpreting-related experience required.

43036	W	6:15pm - 8:20pm	STAFF	66-201
-------	---	-----------------	-------	--------

■ SIGN 250 — Interpreting with Classifiers **1.5 Units**
Degree Applicable

(May be taken for Pass/No Pass Only)

Prerequisites: SIGN 104 and SIGN 210

Common forms of ASL classifier predicates and their application in interpreting from English into American Sign Language.

42570	M and M	3:00pm - 4:05pm 4:15pm - 5:30pm	Augustus, R Augustus, R	66-205 66-205
-------	------------	------------------------------------	----------------------------	------------------

SOCIOLOGY

■ SOC 1 — Sociology (C-ID SOCI 110)

3.0 Units
Degree Applicable, CSU, UC

Prerequisite: Eligibility for ENGL 68

Study of human relations and social structure emphasizing the interaction between personality, culture and society.

42399 TTh 6:20am - 7:45am VanderVis, M 26A-2690

NOTE: No cost digital textbooks or textual materials used.

42400 MW 8:00am - 9:25am Rillorta, L 26D-2491

42401 MW 8:00am - 9:25am Sanchez, I 26A-2871

42402 TTh 8:00am - 9:25am Guerrero, L 26A-2871

42403 TTh 8:00am - 9:25am VanderVis, M 26A-2690

NOTE: No cost digital textbooks or textual materials used.

44783 S 8:00am - 2:30pm Karmiryam, R 26A-2690

42405 MW 9:45am - 11:10am Parker, S 26D-2431

NOTE: No cost digital textbooks or textual materials used.

42406 MW 9:45am - 11:10am Sanchez, I 26A-2871

42407 TTh 9:45am - 11:10am Guerrero, L 26A-2871

42408 TTh 9:45am - 11:10am Gatillon, J 26A-2690

NOTE: No cost digital textbooks or textual materials used.

42409 MW 11:30am - 12:55pm Hernandez-Magallon, K 26D-2431

NOTE: No cost digital textbooks or textual materials used.

44187 MW 11:30am - 12:55pm Gatillon, J 26A-2871

NOTE: No cost digital textbooks or textual materials used.

42411 TTh 11:30am - 12:55pm Coronel, J 26A-2871

NOTE: No cost digital textbooks or textual materials used.

42412 TTh 11:30am - 12:55pm Masl, S 12-1280

NOTE: No cost digital textbooks or textual materials used.

44188 TTh 11:30am - 12:55pm Ramirez, C 80-1331

NOTE: No cost digital textbooks or textual materials used.

42413 F 11:30am - 2:40pm Stewart-Thomas, M 26A-2690

NOTE: No cost digital textbooks or textual materials used.

42414 MW 1:15pm - 2:40pm Gallarde, M 26A-2871

NOTE: No cost digital textbooks or textual materials used.

42415 TTh 1:15pm - 2:40pm Coronel, J 26A-2871

NOTE: No cost digital textbooks or textual materials used.

42416 TTh 1:15pm - 2:40pm Lukenbill, C 26D-2491

44189 TTh 1:15pm - 2:40pm Hernandez-Magallon, K 26D-2431

NOTE: No cost digital textbooks or textual materials used.

42417 MW 3:00pm - 4:25pm Banuelos, M 26A-2690

NOTE: No cost digital textbooks or textual materials used.

42418 TTh 3:00pm - 4:25pm Stewart-Thomas, M 26A-2690

NOTE: No cost digital textbooks or textual materials used.

44190 TTh 3:00pm - 4:25pm Banuelos, M 26A-2871

NOTE: No cost digital textbooks or textual materials used.

44723 Th 7:00pm - 10:10pm Stewart-Thomas, M 26A-2690

42470 arrange 6.75 hours Gallarde, M ONLINE

8 Weeks, Week beginning 02/26/2018 ending 04/22/2018

NOTE: CRN 42470 is a Distance Learning Online Class.

How to Begin Course: Log into Canvas through <http://myportal.mtsac.edu> and click on CRN for your DL course. **NOTE:** Some courses may not be activated until the start of the term. If you cannot locate your DL course in Canvas when the term starts, contact the professor. **On the first day of classes, log into your DL course to show your "attendance" because not doing so could result in your being dropped from the class for non-attendance.**

Professor contact info: Email Professor Gallarde at either: MGallarde@mtsac.edu, through Student Detail Schedule or Canvas at MyMtSAC Portal.

Students must use their Mt. SAC e-mail account and be aware of course commitment and student expectations described at <http://www.mtsac.edu/instruction/learning/distlearn/>

To prepare for a successful online learning experience, see helpful short videos at <http://www.mtsac.edu/distancelearning/quiz/>

No cost digital textbooks or textual materials used.

42471 arrange 6.75 hours Gallarde, M ONLINE

8 Weeks, Week beginning 02/26/2018 ending 04/22/2018

NOTE: CRN 42471 is a Distance Learning Online Class.

How to Begin Course: Log into Canvas through <http://myportal.mtsac.edu> and click on CRN for your DL course. **NOTE:** Some courses may not be activated until the start of the term. If you cannot locate your DL course in Canvas when the term starts, contact the professor. **On the first day of classes, log into your DL course to show your "attendance" because not doing so could result in your being dropped from the class for non-attendance.**

Professor contact info: Email Professor Gallarde at either: MGallarde@mtsac.edu, through Student Detail Schedule or Canvas at MyMtSAC Portal.

Students must use their Mt. SAC e-mail account and be aware of course commitment and student expectations described at <http://www.mtsac.edu/instruction/learning/distlearn/>

To prepare for a successful online learning experience, see helpful short videos at <http://www.mtsac.edu/distancelearning/quiz/>

No cost digital textbooks or textual materials used.

42472 arrange 6.75 hours Gallarde, M ONLINE

8 Weeks, Week beginning 02/26/2018 ending 04/23/2018

NOTE: CRN 42472 is a Distance Learning Online Class.

How to Begin Course: Log into Canvas through <http://myportal.mtsac.edu> and click on CRN for your DL course. **NOTE:** Some courses may not be activated until the start of the term. If you cannot locate your DL course in Canvas when the term starts, contact the professor. **On the first day of classes, log into your DL course to show your "attendance" because not doing so could result in your being dropped from the class for non-attendance.**

Professor contact info: Email Professor Gallarde at either: MGallarde@mtsac.edu, through Student Detail Schedule or Canvas at MyMtSAC Portal.

Students must use their Mt. SAC e-mail account and be aware of course commitment and student expectations described at <http://www.mtsac.edu/instruction/learning/distlearn/>

To prepare for a successful online learning experience, see helpful short videos at <http://www.mtsac.edu/distancelearning/quiz/>

No cost digital textbooks or textual materials used.

42473 arrange 6.75 hours Hernandez-Magallon, K ONLINE

8 Weeks, Week beginning 02/26/2018 ending 04/23/2018

NOTE: CRN 42473 is a Distance Learning Online Class.

How to Begin Course: Log into Canvas through <http://myportal.mtsac.edu> and click on CRN for your DL course. **NOTE:** Some courses may not be activated until the start of the term. If you cannot locate your DL course in Canvas when the term starts, contact the professor. **On the first day of classes, log into your DL course to show your "attendance" because not doing so could result in your being dropped from the class for non-attendance.**

Professor contact info: Email Professor Hernandez-Magallon at either: KHernandezMagallon@mtsac.edu, through Student Detail Schedule or Canvas at MyMtSAC Portal.

Students must use their Mt. SAC e-mail account and be aware of course commitment and student expectations described at <http://www.mtsac.edu/instruction/learning/distlearn/>

To prepare for a successful online learning experience, see helpful short videos at <http://www.mtsac.edu/distancelearning/quiz/>

No cost digital textbooks or textual materials used.

42474 arrange 3.4 hours Montero, S ONLINE
NOTE: CRN 42474 is a Distance Learning Online Class.

How to Begin Course: Log into Moodlerooms through <http://myportal.mtsac.edu> and click on CRN for your DL course. **NOTE:** Some courses may not be activated until the start of the term. If you cannot locate your DL course in Moodlerooms when the term starts, contact the professor. **On the first day of classes, log into your DL course to show your "attendance" because not doing so could result in your being dropped from the class for non-attendance.**

Professor contact info: Email Professor Montero at either: SMontero@mtsac.edu, through Student Detail Schedule or Moodlerooms at MyMtSAC Portal.

Students must use their Mt. SAC e-mail account and be aware of course commitment and student expectations described at <http://www.mtsac.edu/instruction/learning/distlearn/>

To prepare for a successful online learning experience, see helpful short videos at <http://www.mtsac.edu/distancelearning/quiz/>

43067 arrange 6.75 hours Hernandez-Magallon, K ONLINE
8 Weeks, Week beginning 04/23/2018 ending 06/17/2018

NOTE: CRN 43067 is a Distance Learning Online Class.

How to Begin Course: Log into Canvas through <http://myportal.mtsac.edu> and click on CRN for your DL course. **NOTE:** Some courses may not be activated until the start of the term. If you cannot locate your DL course in Canvas when the term starts, contact the professor. **On the first day of classes, log into your DL course to show your "attendance" because not doing so could result in your being dropped from the class for non-attendance.**

Professor contact info: Email Professor Hernandez-Magallon at either: KHernandezMagallon@mtsac.edu, through Student Detail Schedule or Canvas at MyMtSAC Portal.

Students must use their Mt. SAC e-mail account and be aware of course commitment and student expectations described at <http://www.mtsac.edu/instruction/learning/distlearn/>

To prepare for a successful online learning experience, see helpful short videos at <http://www.mtsac.edu/distancelearning/quiz/>

No cost digital textbooks or textual materials used.

43070 arrange 6.75 hours Ramirez, C ONLINE
8 Weeks, Week beginning 04/23/2018 ending 06/17/2018

NOTE: CRN 43070 is a Distance Learning Online Class.

How to Begin Course: Log into Canvas through <http://myportal.mtsac.edu> and click on CRN for your DL course. **NOTE:** Some courses may not be activated until the start of the term. If you cannot locate your DL course in Canvas when the term starts, contact the professor. **On the first day of classes, log into your DL course to show your "attendance" because not doing so could result in your being dropped from the class for non-attendance.**

Professor contact info: Email Professor Ramirez at either: CQuach2@mtsac.edu, through Student Detail Schedule or Canvas at MyMtSAC Portal.

Students must use their Mt. SAC e-mail account and be aware of course commitment and student expectations described at <http://www.mtsac.edu/instruction/learning/distlearn/>

To prepare for a successful online learning experience, see helpful short videos at <http://www.mtsac.edu/distancelearning/quiz/>

No cost digital textbooks or textual materials used.

■ **SOC 1H — Sociology - Honors** 3.0 Units
 (C-ID SOCI 110) Degree Applicable, CSU, UC

Prerequisite: Acceptance into the Honors Program

Honors course designed to provide an enriched experience. May not receive credit for both SOC 1 and SOC 1H.

42589 MW 11:30am - 12:55pm Rillorta, L 26D-2230

■ **SOC 2 — Contemporary Social Problems** 3.0 Units
 (C-ID SOCI 115) Degree Applicable, CSU, UC

Prerequisite: Eligibility for ENGL 68

Basic sociological principles and concepts to the study and understanding of social problems.

42419 MW 9:45am - 11:10am Moss, J 20-5

NOTE: No cost digital textbooks or textual materials used.

42420 MW 1:15pm - 2:40pm Rillorta, L 26D-2230

42557 TTh 1:15pm - 2:40pm Rillorta, L 26D-2230

42558 T 7:00pm - 10:10pm Stewart-Thomas, M 26A-2690

NOTE: No cost digital textbooks or textual materials used.

42597 arrange 6.75 hours Morales Beasley, S ONLINE

8 Weeks, Week beginning 04/23/2018 ending 06/17/2018

NOTE: CRN 42597 is a Distance Learning Online Class.

How to Begin Course: Log into Canvas through <http://myportal.mtsac.edu> and click on CRN for your DL course. **NOTE:** Some courses may not be activated until the start of the term. If you cannot locate your DL course in Canvas when the term starts, contact the professor. **On the first day of classes, log into your DL course to show your "attendance" because not doing so could result in your being dropped from the class for non-attendance.**

Professor contact info: Email Professor Morales Beasley at either: SMorales2@mtsac.edu, through Student Detail Schedule or Canvas at MyMtSAC Portal.

Students must use their Mt. SAC e-mail account and be aware of course commitment and student expectations described at <http://www.mtsac.edu/instruction/learning/distlearn/>

To prepare for a successful online learning experience, see helpful short videos at <http://www.mtsac.edu/distancelearning/quiz/>

44784 arrange 6.75 hours Yoshioka, G ONLINE
8 Weeks, Week beginning 04/23/2018 ending 06/17/2018

NOTE: CRN 42597 is a Distance Learning Online Class.

How to Begin Course: Log into Canvas through <http://myportal.mtsac.edu> and click on CRN for your DL course. **NOTE:** Some courses may not be activated until the start of the term. If you cannot locate your DL course in Canvas when the term starts, contact the professor. **On the first day of classes, log into your DL course to show your "attendance" because not doing so could result in your being dropped from the class for non-attendance.**

Professor contact info: Email Professor Yoshioka at either: GYoshioka@mtsac.edu, through Student Detail Schedule or Canvas at MyMtSAC Portal.

Students must use their Mt. SAC e-mail account and be aware of course commitment and student expectations described at <http://www.mtsac.edu/instruction/learning/distlearn/>

To prepare for a successful online learning experience, see helpful short videos at <http://www.mtsac.edu/distancelearning/quiz/>

42598 arrange 3.4 hours Guerrero, L ONLINE

NOTE: CRN 42598 is a Distance Learning Online Class.

How to Begin Course: Log into Canvas through <http://myportal.mtsac.edu> and click on CRN for your DL course. **NOTE:** Some courses may not be activated until the start of the term. If you cannot locate your DL course in Canvas when the term starts, contact the professor. **On the first day of classes, log into your DL course to show your "attendance" because not doing so could result in your being dropped from the class for non-attendance.**

Professor contact info: Email Professor Guerrero at either: LGuerrero@mtsac.edu, through Student Detail Schedule or Canvas at MyMtSAC Portal.

Students must use their Mt. SAC e-mail account and be aware of course commitment and student expectations described at <http://www.mtsac.edu/instruction/learning/distlearn/>

To prepare for a successful online learning experience, see helpful short videos at <http://www.mtsac.edu/distancelearning/quiz/>

■ **SOC 5 — Introduction to Criminology** **3.0 Units**
(C-ID SOCI 160) Degree Applicable, CSU, UC

Prerequisite: Eligibility for ENGL 68

A scientific analysis of violations of societal rules of behavior that are formally defined as crime and delinquency.

42421	MW	8:00am - 9:25am	Lukenbill, C	26D-2240
42422	MW	9:45am - 11:10am	Masl, S	26A-1690
42423	MW	11:30am - 12:55pm	Cretney, C	26A-1690
42424	TTh	11:30am - 12:55pm	Parker, S	26A-1690
42425	TTh	1:15pm - 2:40pm	Banuelos, M	26A-2690
42426	MW	3:00pm - 4:25pm	Cretney, C	26A-1690
42552	arrange	6.75 hours	Irvine, C	ONLINE

8 Weeks, Week beginning 04/23/2018 ending 06/17/2018

NOTE: CRN 42552 is a Distance Learning Online Class.

How to Begin Course: Log into Moodle rooms through <http://myportal.mtsac.edu> and click on CRN for your DL course. **NOTE:** Some courses may not be activated until the start of the term. If you cannot locate your DL course in Moodle rooms when the term starts, contact the professor. **On the first day of classes, log into your DL course to show your "attendance" because not doing so could result in your being dropped from the class for non-attendance.**

Professor contact info: Email Professor Irvine at either: Clrvine@mtsac.edu, through Student Detail Schedule or Moodle rooms at MyMtSAC Portal.

Students must use their Mt. SAC e-mail account and be aware of course commitment and student expectations described at <http://www.mtsac.edu/instruction/learning/distlearn/>

To prepare for a successful online learning experience, see helpful short videos at <http://www.mtsac.edu/distancelearning/quiz/>

42559	arrange	6.75 hours	Tolmasov, B	ONLINE
-------	---------	------------	-------------	--------

8 Weeks, Week beginning 02/26/2018 ending 04/22/2018

NOTE: CRN 42559 is a Distance Learning Online Class.

How to Begin Course: Log into Canvas through <http://myportal.mtsac.edu> and click on CRN for your DL course. **NOTE:** Some courses may not be activated until the start of the term. If you cannot locate your DL course in Canvas when the term starts, contact the professor. **On the first day of classes, log into your DL course to show your "attendance" because not doing so could result in your being dropped from the class for non-attendance.**

Professor contact info: Email Professor Tolmasov at either: BTolmasov@mtsac.edu, through Student Detail Schedule or Canvas at MyMtSAC Portal.

Students must use their Mt. SAC e-mail account and be aware of course commitment and student expectations described at <http://www.mtsac.edu/instruction/learning/distlearn/>

To prepare for a successful online learning experience, see helpful short videos at <http://www.mtsac.edu/distancelearning/quiz/>

42560	arrange	6.75 hours	Sanchez, I	ONLINE
-------	---------	------------	------------	--------

8 Weeks, Week beginning 02/26/2018 ending 04/22/2018

NOTE: CRN 42560 is a Distance Learning Online Class.

How to Begin Course: Log into Canvas through <http://myportal.mtsac.edu> and click on CRN for your DL course. **NOTE:** Some courses may not be activated until the start of the term. If you cannot locate your DL course in Canvas when the term starts, contact the professor. **On the first day of classes, log into your DL course to show your "attendance" because not doing so could result in your being dropped from the class for non-attendance.**

Professor contact info: Email Professor Sanchez at either: ISanchez47@mtsac.edu, through Student Detail Schedule or Canvas at MyMtSAC Portal.

Students must use their Mt. SAC e-mail account and be aware of course commitment and student expectations described at <http://www.mtsac.edu/instruction/learning/distlearn/>

To prepare for a successful online learning experience, see helpful short videos at <http://www.mtsac.edu/distancelearning/quiz/>

43062	arrange	6.75 hours	Moss, J	ONLINE
-------	---------	------------	---------	--------

8 Weeks, Week beginning 04/23/2018 ending 06/17/2018

NOTE: CRN 43062 is a Distance Learning Online Class.

How to Begin Course: Log into Moodle rooms through <http://myportal.mtsac.edu> and click on CRN for your DL course. **NOTE:** Some courses may not be activated until the start of the term. If you cannot locate your DL course in Moodle rooms when the term starts, contact the professor.

On the first day of classes, log into your DL course to show your "attendance" because not doing so could result in your being dropped from the class for non-attendance.

Professor contact info: Email Professor Moss at either: JMoss9@mtsac.edu, through Student Detail Schedule or Moodle rooms at MyMtSAC Portal.

Students must use their Mt. SAC e-mail account and be aware of course commitment and student expectations described at <http://www.mtsac.edu/instruction/learning/distlearn/>

To prepare for a successful online learning experience, see helpful short videos at <http://www.mtsac.edu/distancelearning/quiz/>

43068	arrange	6.75 hours	Moss, J	ONLINE
-------	---------	------------	---------	--------

8 Weeks, Week beginning 04/23/2018 ending 06/17/2018

NOTE: CRN 43068 is a Distance Learning Online Class.

How to Begin Course: Log into Moodle rooms through <http://myportal.mtsac.edu> and click on CRN for your DL course. **NOTE:** Some courses may not be activated until the start of the term. If you cannot locate your DL course in Moodle rooms when the term starts, contact the professor.

On the first day of classes, log into your DL course to show your "attendance" because not doing so could result in your being dropped from the class for non-attendance.

Professor contact info: Email Professor Moss at either: JMoss9@mtsac.edu, through Student Detail Schedule or Moodle rooms at MyMtSAC Portal.

Students must use their Mt. SAC e-mail account and be aware of course commitment and student expectations described at <http://www.mtsac.edu/instruction/learning/distlearn/>

To prepare for a successful online learning experience, see helpful short videos at <http://www.mtsac.edu/distancelearning/quiz/>

43069	arrange	6.75 hours	Ramirez, C	ONLINE
-------	---------	------------	------------	--------

8 Weeks, Week beginning 04/23/2018 ending 06/17/2018

NOTE: CRN 43069 is a Distance Learning Online Class.

How to Begin Course: Log into Canvas through <http://myportal.mtsac.edu> and click on CRN for your DL course. **NOTE:** Some courses may not be activated until the start of the term. If you cannot locate your DL course in Canvas when the term starts, contact the professor. **On the first day of classes, log into your DL course to show your "attendance" because not doing so could result in your being dropped from the class for non-attendance.**

Professor contact info: Email Professor Quach at either: CQuach2@mtsac.edu, through Student Detail Schedule or Canvas at MyMtSAC Portal.

Students must use their Mt. SAC e-mail account and be aware of course commitment and student expectations described at <http://www.mtsac.edu/instruction/learning/distlearn/>

To prepare for a successful online learning experience, see helpful short videos at <http://www.mtsac.edu/distancelearning/quiz/>

43075	arrange	6.75 hours	Tolmasov, B	ONLINE
-------	---------	------------	-------------	--------

8 Weeks, Week beginning 04/23/2018 ending 06/17/2018

NOTE: CRN 43075 is a Distance Learning Online Class.

How to Begin Course: Log into Moodle rooms through <http://myportal.mtsac.edu> and click on CRN for your DL course. **NOTE:** Some courses may not be activated until the start of the term. If you cannot locate your DL course in Moodle rooms when the term starts, contact the professor. **On the first day of classes, log into your DL course to show your "attendance" because not doing so could result in your being dropped from the class for non-attendance.**

Professor contact info: Email Professor Tolmasov at either: BTolmasov@mtsac.edu, through Student Detail Schedule or Moodle rooms at MyMtSAC Portal.

Students must use their Mt. SAC e-mail account and be aware of course commitment and student expectations described at <http://www.mtsac.edu/instruction/learning/distlearn/>

To prepare for a successful online learning experience, see helpful short videos at <http://www.mtsac.edu/distancelearning/quiz/>

■ SOC 7 — Sociology of Religion **3.0 Units**

Degree Applicable, CSU, UC

Analysis of religion as a social institution. The influence of religion on American society. Field trips may be required.

42427 M 7:00pm - 10:10pm Lane, D 26D-2431
NOTE: No cost digital textbooks or textual materials used.
42561 arrange 6.75 hours Morales Beasley, S ONLINE
8 Weeks, Week beginning 02/26/2018 ending 04/22/2018
NOTE: CRN 42561 is a Distance Learning Online Class.

How to Begin Course: Log into Canvas through <http://myportal.mtsac.edu> and click on CRN for your DL course. **NOTE:** Some courses may not be activated until the start of the term. If you cannot locate your DL course in Canvas when the term starts, contact the professor. **On the first day of classes, log into your DL course to show your "attendance" because not doing so could result in your being dropped from the class for non-attendance.**

Professor contact info: Email Professor Morales Beasley at either: SMorales2@mtsac.edu, through Student Detail Schedule or Canvas at MyMtSAC Portal.

Students must use their Mt. SAC e-mail account and be aware of course commitment and student expectations described at <http://www.mtsac.edu/instruction/learning/distlearn/>

To prepare for a successful online learning experience, see helpful short videos at <http://www.mtsac.edu/distancelearning/quiz/>

■ SOC 14 — Marriage and the Family **3.0 Units**

(C-ID SOCI 130)

Degree Applicable, CSU, UC

Prerequisite: Eligibility for ENGL 68

Sociological functions of dating, engagement, weddings, marriage, and the family.

42428 TTh 11:30am - 12:55pm Rillorta, L 26D-2491
42429 W 7:00pm - 10:10pm Stewart-Thomas, M 26A-2690
NOTE: No cost digital textbooks or textual materials used.
44785 arrange 6.75 hours Yoshioka, G ONLINE
NOTE: CRN 44785 is a Distance Learning Online Class.

How to Begin Course: Log into Moodle rooms through <http://myportal.mtsac.edu> and click on CRN for your DL course. **NOTE:** Some courses may not be activated until the start of the term. If you cannot locate your DL course in Moodle rooms when the term starts, contact the professor. **On the first day of classes, log into your DL course to show your "attendance" because not doing so could result in your being dropped from the class for non-attendance.**

Professor contact info: Email Professor Yoshioka at either: GYoshioka@mtsac.edu, through Student Detail Schedule or Moodle rooms at MyMtSAC Portal.

Students must use their Mt. SAC e-mail account and be aware of course commitment and student expectations described at <http://www.mtsac.edu/instruction/learning/distlearn/>

To prepare for a successful online learning experience, see helpful short videos at <http://www.mtsac.edu/distancelearning/quiz/>

42475 arrange 6.75 hours VanderVis, M ONLINE
8 Weeks, Week beginning 02/26/2018 ending 04/22/2018
NOTE: CRN 42474 is a Distance Learning Online Class.

How to Begin Course: Log into Moodle rooms through <http://myportal.mtsac.edu> and click on CRN for your DL course. **NOTE:** Some courses may not be activated until the start of the term. If you cannot locate your DL course in Moodle rooms when the term starts, contact the professor. **On the first day of classes, log into your DL course to show your "attendance" because not doing so could result in your being dropped from the class for non-attendance.**

Professor contact info: Email Professor Vandervis at either: MVandervis@mtsac.edu, through Student Detail Schedule or Moodle rooms at MyMtSAC Portal.

Students must use their Mt. SAC e-mail account and be aware of course commitment and student expectations described at <http://www.mtsac.edu/instruction/learning/distlearn/>

To prepare for a successful online learning experience, see helpful short videos at <http://www.mtsac.edu/distancelearning/quiz/>

No cost digital textbooks or textual materials used.
42599 arrange 6.75 hours Montero, S ONLINE
8 Weeks, Week beginning 02/26/2018 ending 04/22/2018
NOTE: CRN 42599 is a Distance Learning Online Class.

How to Begin Course: Log into Moodle rooms through <http://myportal.mtsac.edu> and click on CRN for your DL course. **NOTE:** Some courses may not be activated until the start of the term. If you cannot locate your DL course in Moodle rooms when the term starts, contact the professor. **On the first day of classes, log into your DL course to show your "attendance" because not doing so could result in your being dropped from the class for non-attendance.**

Professor contact info: Email Professor Montero at either: SMontero@mtsac.edu, through Student Detail Schedule or Moodle rooms at MyMtSAC Portal.

Students must use their Mt. SAC e-mail account and be aware of course commitment and student expectations described at <http://www.mtsac.edu/instruction/learning/distlearn/>

To prepare for a successful online learning experience, see helpful short videos at <http://www.mtsac.edu/distancelearning/quiz/>

■ SOC 15 — Child Development **3.0 Units**

Degree Applicable, CSU, UC

Prerequisite: Eligibility for ENGL 68

Theoretical aspects of development from conception through adolescence. Requires observation of children.

42623 TTh 9:45am - 11:10am Rillorta, L 26D-2491
42476 arrange 6.75 hours Howey, D ONLINE
8 Weeks, Week beginning 02/26/2018 ending 04/22/2018
NOTE: CRN 42476 is a Distance Learning Online Class.

How to Begin Course: Log into Moodle rooms through <http://myportal.mtsac.edu> and click on CRN for your DL course. **NOTE:** Some courses may not be activated until the start of the term. If you cannot locate your DL course in Moodle rooms when the term starts, contact the professor. **On the first day of classes, log into your DL course to show your "attendance" because not doing so could result in your being dropped from the class for non-attendance.**

Professor contact info: Email Professor Howey at either: DHowey@mtsac.edu, through Student Detail Schedule or Moodle rooms at MyMtSAC Portal.

Students must use their Mt. SAC e-mail account and be aware of course commitment and student expectations described at <http://www.mtsac.edu/instruction/learning/distlearn/>

To prepare for a successful online learning experience, see helpful short videos at <http://www.mtsac.edu/distancelearning/quiz/>

42477 arrange 3.4 hours Irvine, C ONLINE
NOTE: CRN 42477 is a Distance Learning Online Class.

How to Begin Course: Log into Moodle rooms through <http://myportal.mtsac.edu> and click on CRN for your DL course. **NOTE:** Some courses may not be activated until the start of the term. If you cannot locate your DL course in Moodle rooms when the term starts, contact the professor. **On the first day of classes, log into your DL course to show your "attendance" because not doing so could result in your being dropped from the class for non-attendance.**

Professor contact info: Email Professor Irvine at either: CIrvine@mtsac.edu, through Student Detail Schedule or Moodle rooms at MyMtSAC Portal.

Students must use their Mt. SAC e-mail account and be aware of course commitment and student expectations described at <http://www.mtsac.edu/instruction/learning/distlearn/>

To prepare for a successful online learning experience, see helpful short videos at <http://www.mtsac.edu/distancelearning/quiz/>

■ SOC 20 — Sociology of Ethnic Relations **3.0 Units**
(C-ID SOCI 150) Degree Applicable, CSU, UC

Prerequisite: Eligibility for ENGL 68

Ethnic and racial groups in the U.S. and social factors leading to prejudice, discrimination, and stereotypes.

42430 TTh 11:30am - 12:55pm Gatillon, J 26A-2690
42478 arrange 6.75 hours Hernandez-Magallon, K ONLINE

8 Weeks, Week beginning 02/26/2018 ending 04/22/2018

NOTE: CRN 42478 is a Distance Learning Online Class.

How to Begin Course: Log into Canvas through <http://myportal.mtsac.edu> and click on CRN for your DL course. **NOTE:** Some courses may not be activated until the start of the term. If you cannot locate your DL course in Canvas when the term starts, contact the professor. **On the first day of classes, log into your DL course to show your "attendance" because not doing so could result in your being dropped from the class for non-attendance.**

Professor contact info: Email Professor Hernandez-Magallon at either: KHernandezMagallon@mtsac.edu, through Student Detail Schedule or Canvas at MyMtSAC Portal.

Students must use their Mt. SAC e-mail account and be aware of course commitment and student expectations described at <http://www.mtsac.edu/instruction/learning/distlearn/>

To prepare for a successful online learning experience, see helpful short videos at <http://www.mtsac.edu/distancelearning/quiz/>

■ SOC 20H — Sociology of Ethnic Relations - Honors **3.0 Units**
(C-ID SOCI 150) Degree Applicable, CSU, UC

Prerequisite: Acceptance into the Honors Program

An honors course designed to provide an enriched experience. May not receive credit for both SOC 20 and SOC 20H.

43023 MW 9:45am - 11:10am Rillorta, L 26D-2230

■ SOC 99 — Special Projects in Sociology **2.0 Units**
Degree Applicable, CSU

42431 arrange 2.25 hours Rillorta, L OCAM

SPANISH

■ SPAN 1 — Elementary Spanish **4.0 Units**
Degree Applicable, CSU, UC

Conversing, reading, and writing in Spanish at the elementary level.

42968 MW 7:30am - 9:35am Labrit, G 20-1
42969 MW 7:30am - 9:35am Zumaeta, H 26B-3565
42972 MW 7:30am - 9:35am Boada, M 21J-2
42970 TTh 7:30am - 9:35am Fuentes, A 18-11
42971 TTh 7:30am - 9:35am Sanchez, L 26B-3565
42973 F 9:00am - 1:15pm Howell, L 66-248
42974 MW 9:45am - 11:50am Labrit, G 20-1
42975 MW 9:45am - 11:50am Howell, L 66-248
42976 MW 9:45am - 11:50am Sanchez, L 26B-3565
42977 MW 9:45am - 11:50am Boada, M 21J-2
42978 TTh 9:45am - 11:50am Howell, L 26B-3561
42979 TTh 9:45am - 11:50am Fuentes, A 18-11
42980 TTh 9:45am - 2:00pm Kemp, K 66-248

8 Weeks, Week beginning 02/26/2018 ending 04/22/2018

43017 TTh 9:45am - 11:50am Leyva, E 17-13
42981 MW 12:00pm - 2:05pm Castillejos, M 66-267
42982 MW 12:00pm - 2:05pm Zumaeta, H 21J-1
42983 MW 12:00pm - 2:05pm Louis, I 40-131
43020 MW 12:00pm - 2:05pm Garcia, V 80-1421
42984 TTh 12:00pm - 2:05pm Salinger, A 21F-1
42985 TTh 12:00pm - 2:05pm STAFF 40-125
42986 TTh 12:00pm - 2:05pm Blake, M 18-13
42987 MW 2:15pm - 4:20pm Louis, I 40-131
42988 MW 2:15pm - 4:20pm Reyes, A 66-248
42989 TTh 2:15pm - 4:20pm Blake, M 18-13
42990 TTh 2:15pm - 4:20pm Vogel, E 26B-3565
42991 TTh 2:15pm - 4:20pm Baler, P 26B-3561
42992 MW 4:30pm - 6:35pm Kemp, K 66-248
42993 MW 4:30pm - 6:35pm Ugas-Abreus, B 26B-3555
42994 TTh 4:30pm - 6:35pm Kemp, K 66-248
42995 TTh 4:30pm - 6:35pm Baler, P 26B-3561
42996 MW 6:45pm - 8:50pm Kogat, L 26B-3561
42997 MW 6:45pm - 8:50pm Ugas-Abreus, B 26B-3555
42998 TTh 6:45pm - 8:50pm STAFF 66-248

■ SPAN 1S — Spanish for the Spanish Speaking **4.0 Units**
Degree Applicable, CSU, UC

Provides Spanish-speaking students opportunity to improve skills in standard Spanish grammar and vocabulary. Instruction in Spanish.

44128 MW 7:30am - 9:35am Howell, L 66-248
44129 TTh 7:30am - 9:35am Howell, L 26B-3561
44130 MW 9:45am - 11:50am Castillejos, M 66-267
44131 TTh 9:45am - 11:50am Salinger, A 21F-1
44132 TTh 9:45am - 11:50am Sanchez, L 26B-3565
44133 MW 12:00pm - 2:05pm Salinger, A 26B-3561
44134 TTh 12:00pm - 2:05pm Castillejos, M 66-267
44135 TTh 12:00pm - 2:05pm Leyva, E 17-13
44136 TTh 2:15pm - 4:20pm STAFF 40-125
44137 TTh 4:30pm - 6:35pm Vogel, E 26B-3565
44138 MW 6:45pm - 8:50pm Lyon, N 66-267

■ SPAN 2 — Continuing Elementary Spanish **4.0 Units**
Degree Applicable, CSU, UC

Prerequisite: SPAN 1

Further development of conversational, reading, and writing skills in Spanish. Further study of Hispanic culture.

43001 MW 9:45am - 11:50am Garcia, V 80-1421
43000 TTh 9:45am - 2:00pm Kemp, K 66-248

8 Weeks, Week beginning 04/23/2018 ending 06/17/2018

42999 MW 12:00pm - 2:05pm Sanchez, L 26B-3565
43002 MW 4:30pm - 6:35pm Kogat, L 26B-3561

■ SPAN 2S — Continuing Spanish for the Spanish Speaking **4.0 Units**
Degree Applicable, CSU, UC

Prerequisite: SPAN 1S or SPAN 11 or equivalent

Gives Spanish-speaking students further development and improvement of Spanish language and reading skills. Instruction in Spanish.

44139 MW 9:45am - 11:50am Salinger, A 26B-3561
44140 TTh 9:45am - 11:50am Castillejos, M 66-267
44141 MW 4:30pm - 6:35pm Lyon, N 66-267

NOTE: No cost digital textbooks or textual materials used.

■ SPAN 3 — Intermediate Spanish **4.0 Units**
Degree Applicable, CSU, UC

(May be taken for option of Letter grade or Pass/NoPass)

Prerequisite: SPAN 2

Further development of communicative proficiency in Spanish.

43003 MW 12:00pm - 2:05pm Kemp, K 66-248

■ SPAN 4 — Continuing Intermediate Spanish **4.0 Units**
Degree Applicable, CSU, UC

(May be taken for option of Letter grade or Pass/NoPass)

Prerequisite: SPAN 3

Increased proficiency in speaking, reading and writing Spanish.

44125 TTh 2:15pm - 4:20pm Reyes, A 66-248

SPEECH

■ SPCH 1A — Public Speaking **4.0 Units**
 Degree Applicable, CSU, UC

Prerequisite: Eligibility for ENGL 68

Study and apply rhetorical principles to research, write outlines, and deliver speeches. Credit for either SPCH 1A or SPCH 1AH.

42343	MW	7:30am - 9:35am	Crossman, E	21F-1
44314	MW	7:30am - 9:35am	McClure, D	21J-2
42344	TTh	7:30am - 9:35am	Laverty, J	26A-1881
42345	TTh	7:30am - 9:35am	Musallet, O	26D-G481
42346	MW	8:30am - 10:35am	Nahabedian, S	26D-G280
42348	TTh	8:30am - 10:35am	Peterson, E	20-5
42349	F	9:00am - 1:15pm	Perez, C	26A-1891
42350	F	9:00am - 1:15pm	Farschman, K	26D-G280
42351	MTWTh	9:45am - 11:50am	Ferguson, C	26A-1881
8 Weeks, Week beginning 02/26/2018 ending 04/22/2018				
42347	MW	9:45am - 11:50am	Bradshaw, S	40-129
42352	MW	9:45am - 11:50am	Laverty, J	26A-1891
42353	MW	9:45am - 11:50am	Willis, R	26D-G481
42358	MW	9:45am - 11:50am	Crossman, E	21F-1
42481	MW	9:45am - 11:50am	Boehner-Staylor, M	26A-3620
NOTE: CRN 42481 above is linked to ENGL 1A (CRN 42642).				
43049	MW	9:45am - 11:50am	Reynolds, F	21G-1
44315	MW	9:45am - 11:50am	McClure, D	21J-2
42354	TTh	9:45am - 11:50am	Reynolds, F	26A-1891
42355	TTh	9:45am - 11:50am	Jaimes, F	21H-1
42356	TTh	9:45am - 11:50am	Musallet, O	26D-G481
42357	TTh	9:45am - 11:50am	Selnick, S	21G-1
42608	TTh	9:45am - 11:50am	Correa, H	21J-1
42359	MW	10:45am - 12:50pm	Nahabedian, S	26D-G280
42360	MW	10:45am - 12:50pm	Cruz-Pobocik, S	18-17
42361	TTh	10:45am - 12:50pm	Farschman, K	21J-2
42363	TTh	10:45am - 12:50pm	Peterson, E	20-5
42364	MW	12:00pm - 2:05pm	Bradshaw, S	40-129
42365	MW	12:00pm - 2:05pm	Laverty, J	26A-1891
42366	MW	12:00pm - 2:05pm	Reynolds, F	21G-1
42362	TTh	12:00pm - 2:05pm	Jaimes, F	21H-1
42367	TTh	12:00pm - 2:05pm	Ferguson, C	26A-1881
NOTE: CRN 42367 above is designated for deaf students and linked to SIGN 102 (CRN 43389).				
42368	TTh	12:00pm - 2:05pm	Reynolds, F	26A-1891
42489	TTh	12:00pm - 2:05pm	Klawitter, K	26D-G280
42621	TTh	12:00pm - 2:05pm	Correa, H	21J-1
42482	MW	1:00pm - 3:05pm	Arntson, R	26D-G280
42484	MW	1:00pm - 3:05pm	Cruz-Pobocik, S	18-17
42485	MW	1:00pm - 3:05pm	Taylor, W	21H-2
42487	MW	1:00pm - 3:05pm	Moorehead, A	21F-2
42488	MW	1:00pm - 3:05pm	Cornejo, V	26A-1881
42490	TTh	1:00pm - 3:05pm	Walls, R	21J-2
42603	F	1:30pm - 5:45pm	Damico, A	26D-G280
42602	MW	2:15pm - 4:20pm	Klawitter, K	26D-G481
42604	TTh	2:15pm - 4:20pm	Kennelley, E	26A-1881
42610	TTh	2:15pm - 4:20pm	Klawitter, K	26D-G280
42605	MW	3:15pm - 5:20pm	Taylor, W	21H-2
42606	MW	3:15pm - 5:20pm	Moorehead, A	21F-2
42878	MW	3:15pm - 5:20pm	Solorzano, D	26D-G280
43047	MW	3:15pm - 5:20pm	Cornejo, V	26A-1881
42607	TTh	3:15pm - 5:20pm	Rodriguez, C	26D-G481
42609	TTh	3:15pm - 5:20pm	Walls, R	21J-2
42611	TTh	4:30pm - 6:35pm	Kennelley, E	26A-1881
42612	MW	5:30pm - 7:35pm	Solorzano, D	26D-G280
42616	MW	5:30pm - 7:35pm	Baker, R	26D-G481
43045	MW	5:30pm - 7:35pm	Caraballo, S	26A-1881
42876	TTh	5:30pm - 7:35pm	Silverstein, A	26D-G481
43048	MW	7:45pm - 9:50pm	Caraballo, S	26A-1881
42879	TTh	7:45pm - 9:50pm	Silverstein, A	26D-G481
42877	Th	6:00pm - 9:30pm	Reinhart, L	26D-G280
and S	05/05	9:00am - 1:15pm	Reinhart, L	26D-G280
and S	06/02	9:00am - 1:15pm	Reinhart, L	26D-G280

■ SPCH 1AH — Public Speaking - Honors **4.0 Units**
 Degree Applicable, CSU, UC

Prerequisite: Acceptance into the Honors Program

An honors course designed to provide an enriched experience. May not receive credit for both SPCH 1A and SPCH 1AH.

42373 MW 12:00pm - 2:05pm Klawitter, K 26D-G481

■ SPCH 2 — Fundamentals of Communication **4.0 Units**
 Degree Applicable, CSU, UC

Corequisite: ENGL 1A or ENGL 1AH (May have been taken previously)

Fundamentals of interpersonal, small group, public speaking, and inter-cultural communication. Oral presentations are required.

42369 MW 10:45am - 12:50pm Cantrell, D 26D-1411

NOTE: No cost digital textbooks or textual materials used.
■ SPCH 6 — Group Communication **3.0 Units**
 Degree Applicable, CSU, UC

Theory, principles, application and evaluation of group communication processes, problem-solving, decision making, and leadership.

42370 M 1:15pm - 4:25pm Willis, R 26D-1411

■ SPCH 7 — Intercultural Communication **3.0 Units**
 Degree Applicable, CSU, UC

Theoretical dynamics of culture within communication contexts. Students may not receive credit for both SPCH 7 and SPCH 7H.

42371 TWTh 9:45am - 11:50am Arntson, R 26A-1881

8 Weeks, Week beginning 04/23/2018 ending 06/17/2018
NOTE: No cost digital textbooks or textual materials used.

42620 Th 1:45pm - 4:55pm McLeod, J 26D-G471

■ SPCH 8 — Professional and Organizational Speaking **4.0 Units**
 Degree Applicable, CSU

Corequisite: ENGL 1A or ENGL 1AH (may have been taken previously)

Speech communication principles in the workplace. Oral presentations are required.

42372 TTh 9:45am - 11:50am Laverty, J 26D-1411

NOTE: No cost digital textbooks or textual materials used.
■ SPCH 16 — Forensics: Individual Event Team **3.0 Units**
 Degree Applicable, CSU

(May be taken four times for credit)

Prerequisite: Admission by audition

Participation in multiple intercollegiate speaking competitions with the Mt. SAC Forensics Team. Tournament attendance required.

42617 T 4:30pm - 6:35pm Willis, R 26D-1441

and arrange 11.75 hours Cantrell, D 26D-1441

12 Weeks, Week beginning 02/26/2018 ending 05/20/2018
NOTE: For audition information, email forensics@mtsac.edu.
■ SPCH 18 — Forensics: Reader's Theater Team **3.0 Units**
 Degree Applicable, CSU

(May be taken four times for credit)

Prerequisite: SPCH 15

Performance of readers theater as part of Mt. SAC's Forensics Team.

Required participation in readers theater competition.

42374 T 7:00pm - 10:10pm McLeod, J 26D-1441

and arrange 10.75 hours Klawitter, K 26D-1441

12 Weeks, Week beginning 02/26/2018 ending 05/20/2018
■ SPCH 20 — Argumentation and Debate **3.0 Units**
 Degree Applicable, CSU, UC

Prerequisite: SPCH 1A or SPCH 1AH

Rhetorical principles of argumentation in both theory and practice. Emphasis given to rational discussion and reasoned advocacy.

42618 TTh 1:15pm - 2:40pm Selnick, S 26D-1411

44206 M 6:30pm - 9:40pm Arntson, J 26D-1411

■ **SPCH 26 — Interpersonal Communication** **3.0 Units**
Degree Applicable, CSU, UC

Prerequisite: Eligibility for ENGL 68

Dynamics of everyday one-to-one communication.

42375	TTh	8:00am - 9:25am	Castello, A	26D-G280
42376	TTh	9:45am - 11:10am	Castello, A	26D-G280
43021	TTh	1:15pm - 2:40pm	Rodriguez, C	26D-G481

■ **SPCH 30 — Gateway to Communication Studies** **3.0 Units**
Degree Applicable, CSU, UC

Corequisite: ENGL 1A or ENGL 1AH (may be taken previously)

Advisory: READ 100

Prominent issues in communication theory, introduction to the field of communication, and practice of multiple research methods.

42619	W	1:15pm - 4:25pm	Ferguson, C	26D-1411
-------	---	-----------------	-------------	----------

STUDY TECHNIQUES

■ **STDY 80 — Foundations for Academic Success** **3.0 Units**
Not Degree Applicable

(May be taken for option of Letter grade or Pass/NoPass)

College success course emphasizing skills for academic achievement using a brain-based perspective.

43657	TTh	9:45am - 11:10am	High, K	6-136
43656	MW	1:15pm - 2:40pm	Walker, L	6-134

■ **STDY 85A — Basic Overview of Strategies for Academic Success** **1.0 Unit**
Not Degree Applicable

College success study techniques course emphasizing memory, motivation, note-taking, test-taking, and time managements strategies.

43658	M	3:00pm - 4:05pm	High, K	6-134
-------	---	-----------------	---------	-------

■ **STDY 85C — Online Learning Success Skills** **1.0 Unit**
Not Degree Applicable

Advisory: Eligibility for ENGL 67 and Eligibility for READ 90

College success course for online learning using a brain-based perspective emphasizing introductory skills necessary.

43660	arrange	2.25 hours	Hunter-Bufferington, C	ONLINE
-------	---------	------------	------------------------	--------

8 Weeks, Week beginning 02/26/2018 ending 04/22/2018

NOTE: CRN 43660 is a Distance Learning Online Class.

How to Begin Course: Log into Canvas through the e-Learning Tools tab in the Mt.SAC portal at inside.mtsac.edu. Then click on the Canvas link and then click on CRN for your DL course. **NOTE:** Some courses may not be activated until the start of the term. If you cannot locate your DL course in Canvas when the term starts, contact the professor. **On the first day of classes, log into your DL course to show your "attendance" because not doing so could result in your being dropped from the class for non-attendance.**

Professor contact info: Email Professor Bufferington at either: CBufferington@mtsac.edu, through Student Detail Schedule or Canvas at MyMtSAC Portal.

Students must use their Mt.SAC e-mail account and be aware of course commitment and student expectations described at <http://www.mtsac.edu/distancelearning/>

To prepare for a successful online learning experience, see helpful short videos at <http://www.mtsac.edu/distancelearning/quiz/>

43668 arrange 2.25 hours Hunter-Bufferington, C ONLINE
8 Weeks, Week beginning 04/23/2018 ending 06/17/2018

NOTE: CRN 43668 is a Distance Learning Online Class.

How to Begin Course: Log into Canvas through the e-Learning Tools tab in the Mt.SAC portal at inside.mtsac.edu. Then click on the Canvas link and then click on CRN for your DL course. **NOTE:** Some courses may not be activated until the start of the term. If you cannot locate your DL course in Canvas when the term starts, contact the professor. **On the first day of classes, log into your DL course to show your "attendance" because not doing so could result in your being dropped from the class for non-attendance.**

Professor contact info: Email Professor Bufferington at either: CBufferington@mtsac.edu, through Student Detail Schedule or Canvas at MyMtSAC Portal.

Students must use their Mt.SAC e-mail account and be aware of course commitment and student expectations described at <http://www.mtsac.edu/distancelearning/>

To prepare for a successful online learning experience, see helpful short videos at <http://www.mtsac.edu/distancelearning/quiz/>

■ **STDY 100 — University-level Academic Success Strategies** **3.0 Units**
Degree Applicable, CSU

Advisory: Eligibility for ENGL 68 and eligibility for READ 100

Advanced college success course using a brain-based perspective emphasizing strategies necessary for successful transfer.

43659	MW	9:45am - 11:10am	Walker, L	6-136
-------	----	------------------	-----------	-------

SURVEYING

■ **SURV 1A — Surveying** **3.0 Units**
Degree Applicable, CSU, UC

Prerequisite: MATH 150

Surveying and use of equipment, distance measurement, leveling, area computation, mapping, and error analysis.

41944	M	8:00am - 10:05am	STAFF	11-2107
	and W	8:00am - 11:10am	STAFF	11-2107

■ **SURV 1B — Surveying** **3.0 Units**
Degree Applicable, CSU, UC

Prerequisite: SURV 1A

Land surveying including coordinate geometry, highway curves, volumes, photogrammetry, GPS, and GIS. Field trips are required.

41945	S	8:00am - 11:10am	STAFF	11-2107
	and S	11:30am - 1:35pm	STAFF	11-2107

TECHNOLOGY-RELATED COURSES

■ **TECH 60 — Customer Relations for the Technician** **2.0 Units**
Degree Applicable

Customer relations training (soft skills) for the technician.

44255	F	5:30pm - 10:00pm	Uranga, J	28B-404
-------	---	------------------	-----------	---------

8 Weeks, Week beginning 02/26/2018 ending 04/22/2018

THEATER ARTS

■ **THTR 9 — Introduction to Theater Arts** **3.0 Units**
(C-ID THTR 111) Degree Applicable, CSU, UC

Aesthetic, artistic, technical, and business aspects of theater.

43720	MW	1:15pm - 2:40pm	Burgos, M	13-1220
-------	----	-----------------	-----------	---------

NOTE: CRN 43720: No-cost digital textbooks or textual materials used.

43722	TTh	1:15pm - 2:40pm	Cummings, C	2-T120
-------	-----	-----------------	-------------	--------

43721	TTh	3:00pm - 4:25pm	Burgos, M	TBA
-------	-----	-----------------	-----------	-----

NOTE: CRN 43721: No-cost digital textbooks or textual materials used.

■ **THTR 10 — History of Theater Arts** **3.0 Units**
(C-ID THTR 113) Degree Applicable, CSU, UC

Prerequisite: Eligibility for ENGL 1A

Dramatic literature and the development of dramatic art.

43723	MW	11:30am - 12:55pm	Strand, R	13-1220
-------	----	-------------------	-----------	---------

■ THTR 11 — Principles of Acting I		3.0 Units	
(C-ID THTR 151)		Degree Applicable, CSU, UC	
Introduction to principles and techniques of acting. Analysis and performance of scenes and monologues.			
43724	MW	9:45am - 11:10am	McCrory, K 2-T120
NOTE: CRN 43724: No-cost digital textbooks or textual materials used.			
43728	TTh	9:45am - 11:10am	Brooks, A 2-T120
NOTE: CRN 43728: No-cost digital textbooks or textual materials used.			
43725	MW	11:30am - 12:55pm	Cummings, C 2-T120
43729	TTh	11:30am - 12:55pm	Brooks, A 2-T120
NOTE: CRN 43729: No-cost digital textbooks or textual materials used.			
43726	MW	1:15pm - 2:40pm	Cummings, C 2-T120
43727	MW	3:00pm - 4:25pm	Cummings, C 2-T120
43730	Th	7:00pm - 10:10pm	Cockrum, D 2-T120

■ THTR 12 — Principles of Acting II		3.0 Units	
(C-ID THTR 152)		Degree Applicable, CSU, UC	
<i>Prerequisite:</i> THTR 11			
Practical preparation for professional rehearsal and audition scenarios through advanced scene work and audition technique.			
43731	TTh	1:15pm - 2:40pm	Burgos, M 2-T130
NOTE: CRN 43731: No-cost digital textbooks or textual materials used.			

■ THTR 13 — Play Rehearsal and Performance - Technical		2.0 Units	
		Not Degree Applicable, CSU	
(May be taken four times for credit)			
<i>Prerequisite:</i> Admission by interview			
Planning, preparation, and presentation of college-sponsored dramatic presentations. Emphasis on technical theater.			
43733	MTWTh	7:00pm - 10:10pm	Cummings, C 2-T130
8 Weeks, Week beginning 02/26/2018 ending 04/22/2018			
43734	MTWTh	7:00pm - 10:10pm	Burgos, M 2-T130
8 Weeks, Week beginning 04/23/2018 ending 06/17/2018			

■ THTR 14 — Stagecraft		3.0 Units	
(C-ID THTR 171)		Degree Applicable, CSU, UC	
Theory and practice of scenery construction, scene painting, and stage rigging.			
43737	MW	1:35pm - 2:40pm	Mittler, W 2-T130
and	MW	2:50pm - 4:15pm	Mittler, W 2-T130

■ THTR 15 — Play Rehearsal and Performance - Acting		2.0 Units	
(C-ID THTR 191)		Degree Applicable, CSU, UC	
(May be taken four times for credit)			
(May be taken for option of Letter grade or Pass/NoPass)			
<i>Prerequisite:</i> Admission by audition			
Presentation of college-sponsored plays. Offers acting experiences. Attendance at performances required.			
43739	MTWTh	7:00pm - 10:10pm	Cummings, C 2-T130
8 Weeks, Week beginning 02/26/2018 ending 04/22/2018			
NOTE: CRN 43739 above holds auditions: Monday, February 26th, and Tuesday, February 27th, 2017 at 7:00 PM in 2-T130. Production: "Six Characters in Search of an Author" by Luigi Pirandello. Enrollment is contingent on a successful audition.			
43740	MTWTh	7:00pm - 10:10pm	Burgos, M 2-T130
8 Weeks, Week beginning 04/23/2018 ending 06/17/2018			
NOTE: CRN 43740 above holds auditions: Monday, February 26th, and Tuesday, February 27th, 2017 at 7:00 PM in 2-T130. Production: "26 Pebbles" by Eric Ulloa. Enrollment is contingent on a successful audition.			

■ THTR 16 — Theatrical Make-Up		3.0 Units	
(C-ID THTR 175)		Degree Applicable, CSU, UC	
Theory and practice of makeup for stage. Experience in design and application of various makeup techniques.			
43742	MW	9:45am - 10:35am	Ogden, B 2-T129
and	MW	10:45am - 11:55am	Ogden, B 2-T129

■ THTR 18 — Technical Theater Practicum		1.0 Unit	
(C-ID THTR 192)		Degree Applicable, CSU, UC	
(May be taken four times for credit)			
(May be taken for option of Letter grade or Pass/NoPass)			
Technical preparation and operation of productions presented to the community.			
43744		arrange 3.38 hours	Kelly, S 2-T128
NOTE: CRN 43744: No-cost digital textbooks or textual materials used.			

■ THTR 19 — Theatrical Costuming		3.0 Units	
(C-ID THTR 174)		Degree Applicable, CSU, UC	
Theatrical costuming design, construction, history, fabrics, and rendering techniques for theater, dance, film, or television.			
43745	MW	12:30pm - 1:20pm	Ogden, B 2
and	MW	1:30pm - 2:55pm	Ogden, B 2

■ THTR 26 — Sound for Theater		3.0 Units	
		Not Degree Applicable	
Materials, processes, and concepts of creating audio for the live theater.			
44781	TTh	1:30pm - 4:00pm	STAFF 13-1245

■ THTR 27 — Intro Stage Management		3.0 Units	
		Degree Applicable, CSU	
Analysis and application of stage management for the live theater.			
44782	F	12:20pm - 4:35pm	Uffner-Elliott, N 2-T120
and	Sa	9:30am - 1:45pm	Uffner-Elliott, N 2-T120
6 weeks, Week beginning 5/7/2017 - 6/17/2017			

■ THTR 28 — Directing for the Stage		3.0 Units	
		Degree Applicable, CSU	
<i>Advisory:</i> Eligibility for ENGL 68			
Fundamental techniques for beginning stage directors. Exercises for organizing and executing a rehearsal and production process.			
43747	MW	3:00pm - 4:25pm	Burgos, M 13-1220

WELDING

■ WELD 30 — Metal Sculpture		2.0 Units	
		Degree Applicable, CSU	
Welding processes used in the metal sculpting industry to create three-dimensional art forms.			
41441	Th	1:30pm - 2:20pm	Eisley, B 69-6911
and	Th	2:30pm - 5:45pm	Deines, C 69-6911

■ WELD 40 — Introduction to Welding		2.0 Units	
		Degree Applicable, CSU	
Fundamentals of welding process related to the areas of construction, machine tool, aerospace, and transportation.			
41546	M	8:00am - 8:50am	Newell, A 69-6912
and	M	9:00am - 12:15pm	Newell, A 69-6912
41442	Th	8:00am - 8:50am	Newell, A 69-6911
and	Th	9:00am - 12:15pm	Newell, A 69-6911
41523	M	1:30pm - 2:20pm	Garcia, D 69-6921
and	M	2:30pm - 5:45pm	Garcia, D 69-6921
41443	F	1:30pm - 2:20pm	Newell, A 69-6911
and	F	2:30pm - 5:45pm	Newell, A 69-6911
41444	T	6:00pm - 6:50pm	Osendorf, D 69-6911
and	T	7:00pm - 10:15pm	Osendorf, D 69-6911

WELD 50 — Oxyacetylene Welding**2.0 Units**

Degree Applicable

Oxyfuel fusion, non-fusion welding, and cutting. Develops understanding of fundamental skills in modern welding practices.

41445	W	8:00am - 8:50am	Garcia, D	69-6911
	and W	9:00am - 12:15pm	Garcia, D	69-6911
41524	M	6:00pm - 6:50pm	Garcia, D	69-6911
	and M	7:00pm - 10:15pm	Garcia, D	69-6911
41569	F	6:00pm - 6:50pm	Kuchta, J	69-6911
	and F	7:00pm - 10:15pm	Kuchta, J	69-6911

WELD 51 — Basic Electric Arc Welding**2.0 Units**

Degree Applicable

Advisory: WELD 50

Electric arc welding, standard electrodes and alloy electrode selection, and AWS procedures for certification.

41446	T	8:00am - 8:50am	Londo, D	69-6911
	and T	9:00am - 12:15pm	Londo, D	69-6911
41447	F	6:00pm - 6:50pm	Mulick, B	69-6911
	and F	7:00pm - 10:15pm	Mulick, B	69-6911

WELD 53A — Welding Metallurgy**3.0 Units**

Degree Applicable, CSU

Structure of matter, physical, mechanical properties of metals, principles of alloying, plastic deformation, heat treatment.

41448	W	7:00pm - 10:10pm	Kuchta, J	69-6921
-------	---	------------------	-----------	---------

WELD 70A — Beginning Arc Welding**3.0 Units**

Degree Applicable

Develops manipulative skills and techniques for the welders on the Shielded Metal Arc and Flux-Cored Arc Welding processes.

41449	MW	1:00pm - 1:50pm	Newell, A	69-6911
	and MW	2:00pm - 4:50pm	Newell, A	69-6911
41450	TTh	6:15pm - 7:05pm	Newell, A	69-6911
	and TTh	7:15pm - 10:05pm	Newell, A	69-6911

Mt. SAC's WELDING TECHNOLOGY PROGRAM**WELDING TECHNOLOGY**

**A/C & Refrigeration • Electronics
Aircraft Fabrication & Repair
Bridge & High-Rise Construction
Nuclear Energy • Shipbuilding
& MORE!**

Earn a mini-certificate in less than a year or an A.S. degree.

For more information, call 909-274-4638

**WELD 70B — Intermediate Arc Welding****3.0 Units**

Degree Applicable

Advisory: WELD 70A taken prior

Welding high alloy steel with Shielded Metal Arc (SMAW) and Flux Core Arc (FCAW) welding in vertical and overhead positions.

41525	TTh	8:00am - 8:50am	Garcia, D	69-6911
	and TTh	9:00am - 12:05pm	Garcia, D	69-6911
41451	S	8:30am - 9:35am	Mulick, B	69-6911
	and S	9:45am - 12:05pm	Mulick, B	69-6911
	and S	1:00pm - 4:35pm	Mulick, B	69-6911

WELD 70C — Certification for Welders**3.0 Units**

Degree Applicable

Advisory: WELD 70A taken prior

Building construction for the advanced arc welding student. AWS D1.1 and D1.3 will be reviewed.

41453	TTh	1:00pm - 1:50pm	Garcia, D	69-6911
	and TTh	2:00pm - 4:50pm	Garcia, D	69-6911
41452	MW	5:00pm - 5:50pm	Eisley, B	69-6911
	and MW	6:00pm - 9:10pm	Eisley, B	69-6911

WELD 80 — Construction Fabrication and Welding**3.0 Units**

Degree Applicable

Advisory: WELD 40, WELD 51, WELD 70A

Emphasis on layout skills and applied knowledge as it relates to the area of construction within the welding industry.

41454	S	8:30am - 9:35am	Tapia, R	69-6911
	and S	9:45am - 12:05pm	Tapia, R	69-6911
	and S	1:00pm - 4:35pm	Tapia, R	69-6911

WELD 90A — Gas Tungsten Arc Welding**3.0 Units**

Degree Applicable, CSU

Advisory: WELD 70B taken prior

Advanced Gas Tungsten Arc Welding of steel, aluminum, CRES, exotic metals. All position welds with many surfaces and transitions.

41455	MW	6:15pm - 7:05pm	Khattar, F	69-6911
	and MW	7:15pm - 10:20pm	Khattar, F	69-6911

WELD 90B — Semiautomatic Arc Welding Process**3.0 Units**

Degree Applicable, CSU

Advisory: WELD 70B taken prior

Semiautomatic welding with solid and tubular wires. All position welds with many varying thickness.

41456	MW	6:15pm - 7:05pm	Mendoza, M	69-6911
	and MW	7:15pm - 10:20pm	Mendoza, M	69-6911

Distance Learning Program

What is Distance Learning?

- Distance Learning means taking online classes that are conducted partially or wholly off campus—"at a distance." Students and professors communicate with each other using online and other technologies.

Online Classes

- Online classes are delivered primarily via the Internet and have few or no meetings on campus. See the Schedule note for online classes for any on-campus or other requirements.

Hybrid Classes

- Hybrid classes are partially delivered via the Internet but also have several or many required on-campus meetings. Students registered for hybrid classes must attend the first on-campus class meeting or they will be dropped from the classes.

Requirements

- Distance Learning courses require access to a device with Internet connection using the latest browsers, such as Firefox, Safari, Chrome, or Internet Explorer, and using a Mt. SAC student e-mail address.

Are You Ready for Online Classes?

- Take the online questionnaire for instant results to see if online classes are a good fit for you.
<http://www.mtsac.edu/instruction/learning/distlearn/quiz/survey1.html>
- Students who have taken online classes found them to be equally or more rigorous than regular classes.
- Strong reading, writing, and time management skills are important to success in online classes, according to students who took online classes.

Student Complaint/Grievance Process

- Student complaints may fall into three categories: Academic, Non-Academic or Discrimination Complaints. Please consult the current college Catalog or visit <http://www.mtsac.edu/studentlife/studentgrievances.html> for detailed information regarding the student complaint/grievance process.

For further information regarding Distance Learning, please visit www.mtsac.edu/college/distlearn/, e-mail distancelearning@mtsac.edu or call Library & Learning Resources Division at 909-274-5659.

2018 Spring Distance Learning Program

For complete course information, see the course offerings beginning on page 31.

ONLINE LEARNING COURSES

COURSE	TITLE	REFERENCE NUMBER
ADJU 1	The Administration of Justice System	41399, 41501
AGAG 1	Food Production, Land Use, and Politics - A Global Perspective	44252
AGOR 1	Horticultural Science	41810
AGOR 5	Park Facilities	41811
AHIS 1	Understanding the Visual Arts	44089, 44090
ASTR 8	Introduction to Stars, Galaxies, and the Universe	41974
BUSA 11	Fundamentals of Accounting	41146
BUSA 68	Business Mathematics	41153
BUSA 72	Bookkeeping - Accounting	41154
BUSC 1A	Principles of Economics - Macroeconomics	41244
BUSL 18	Business Law	41129, 41133, 41226
BUSL 19	Advanced Business Law	41193, 41216
BUSM 20	Principles of Business	41157
BUSM 51	Principles of International Business	40936
BUSM 61	Business Organization and Management	41183
BUSM 66	Small Business Management	41195, 44720
BUSR 50	Real Estate Principles	41162
CHLD 10	Child Growth and Lifespan Development	41143
CISB 11	Computer Information Systems	41073, 41074
CISB 15	Microcomputer Applications	41084, 41184
CISN 34	Linux Networking and Security	44075
CISS 21	Network Vulnerabilities and Countermeasures	41119
CISS 23	Network Analysis, Intrusion Detection/Prevention Systems	41121
COUN 5	Career and Life Planning	44240
FASH 8	Introduction to Fashion	41036
FCS 41	Life Management	41228, 41246, 41270
FIRE 13	Principles of Fire and Emergency Services Safety and Survival	41545
FIRE 2	Fire Prevention Technology	41544
GEOG 1	Physical Geography	42455, 42456, 42593, 44177
GEOG 2	Human Geography	42457, 42458
HIST 1	History of the United States	44467, 44468, 44473
HIST 36	Women in American History	43478, 44318, 44319
HRM 51	Introduction to Hospitality	41026, 44156
HRM 52	Food Safety and Sanitation	41255, 41256
KIN 34	Fitness for Living	44285, 44286, 44287
LIBR 1	Library Research Methods and Resources	43669
LIBR 1A	Introduction to Library Research	43670, 44230
MUS 13	Introduction to Music Appreciation	43767, 43768, 43770, 43772, 43774, 43779, 43783, 44576

ONLINE LEARNING COURSES (continued)

COURSE	TITLE	REFERENCE NUMBER
NF 10	Nutrition for Health and Wellness	41046, 41048, 44208
NF 12	Sports Nutrition	44210, 44211
NF 25	Introduction to Nutrition Science	41056, 41264
PHIL 3	Introduction to Logic	42460, 42461, 42615
PHIL 5	Introduction to Philosophy	42462, 42463, 42480, 42885, 42886, 43074, 44163
PHIL 8	Critical Thinking	42464, 42594
PHIL 9	Critical Thinking and Writing	42465, 42887, 44184
PHIL 12	Introduction to Ethics	42466, 42467
PHIL 15	Major World Religions	42468, 42469, 42888
PSYC 1A	Introduction to Psychology	42550, 42551, 42573, 42595, 42596, 43016, 43076, 44191
PSYC 14	Developmental Psychology	44194, 44195, 44198, 44199
PSYC 19	Abnormal Psychology	42890, 44201
PSYC 26	Psychology of Sexuality	44203, 44204
PSYC 5	Psychology of Reasoning and Problem Solving	42614, 42889
READ 100	Analysis and Critical Reading	44146
READ 90	Reading College Texts	44147, 44674
SOC 1	Sociology	42470, 42471, 42472, 42473, 42474, 43067, 43070
SOC 2	Contemporary Social Problems	42597, 42598
SOC 5	Introduction to Criminology	42552, 42559, 42560, 43062, 43068, 43069, 43075
SOC 7	Sociology of Religion	42561
SOC 14	Marriage and the Family	42475, 42599
SOC 15	Child Development	42476, 42477
SOC 20	Sociology of Ethnic Relations	42478
STDY 85C	Online Learning Success Skills	43660, 43668

ONLINE-SUPPORTED (HYBRID) COURSES

COURSE	TITLE	REFERENCE NUMBER
AGOR 1	Horticultural Science	41586, 44176
AGOR 24	Integrated Pest Management	41592
AHIS 4	History of Western Art: Prehistoric Through Gothic	44100, 44101
AHIS 5	History of Western Art: Renaissance Through Modern	44105, 44106
ASTR 5	Introduction to Astronomy	41970
BIOL 1	General Biology	41720, 41807
BUSA 7	Principles of Accounting - Financial	40877, 41175, 43947
BUSA 8	Principles of Accounting - Managerial	40883, 41176, 41265
BUSA 11	Fundamentals of Accounting	41130
BUSM 20	Principles of Business	40933
CHEM 10	Chemistry for Allied Health Majors	41829
CISB 11	Computer Information Systems	41065, 41070, 41075
CISB 15	Microcomputer Applications	41080, 41082, 41083
CISD 11	Database Management - Microsoft Access	41088
CISD 21	Database Management - Microsoft SQL Server	41090
CISD 31	Database Management - Oracle	41092
CISN 24	Window Server Network and Security Administration	41100
CISN 31	Linux Operating System	41102
CISN 34	Linux Networking and Security	44075
CISN 51	Cisco CCNA Networking and Routing	41104
CISP 10	Principles of Object-Oriented Design	41148
CISP 21	Programming in Java	41204
CISP 31	Programming in C++	41111, 41112, 41113
CISP 34	Advanced C++ Programming	41117
CISP 54	Programming for Android Devices	44157
CISS 21	Network Vulnerabilities and Countermeasures	41119
CISS 23	Network Analysis, Intrusion Detection/Prevention Systems	41121
CISS 25	Network Security and Firewalls	44173
CISW 15	Web Site Development	41126
CISW 21	Secure Web Programming with ASP.NET	44069
CISW 31	Secure Web Servers	41127
COUN 5	Career and Life Planning	44240, 44241
ENGL 1A	Freshman Composition	42625, 42652, 42661, 42788, 42790, 42791, 42792, 42832, 42834, 42842, 42880, 42883, 42901, 44475
ENGL 1C	Critical Thinking and Writing	42795, 42796, 42797, 42799, 42800, 42801, 42840, 42843, 42844
ENGL 68	Preparation for College Writing	42760, 42761, 42785, 42786, 42787, 42856, 42857, 44474
JOUR 100	Introduction to Mass Media	42804
MATH 130	College Algebra	42140, 42141, 42142
MATH 50	Pre-Algebra	42026, 42027
NF 12	Sports Nutrition	41233
NF 25	Introduction to Nutrition Science	41051, 41220

2018 Spring Schedule of Short-Term Classes

■ **AERO 104 — Federal Aviation Regulations** **2.0 Units**
Federal Aviation Regulations (FAR) pertaining to pilot certification, aircraft maintenance, and general operating rules.

41423	MW	12:00pm - 2:05pm	Rogus, L	28B-107
8 Weeks, Week beginning 02/26/2018 ending 04/22/2018				
44305	MW	12:00pm - 2:05pm	Rogus, L	28B-107
8 Weeks, Week beginning 04/23/2018 ending 06/17/2018				

■ **AERO 206L — Flight Simulator Laboratory** **.5 Unit**
Flight simulator training in the iGATE PC-ATD simulator in preparation for the instrument rating.

41520	W	12:00pm - 3:10pm	STAFF	28B-103
8 Weeks, Week beginning 04/23/2018 ending 06/17/2018				

AIR TRAFFIC CONTROL

■ **AIRT 251 — Air Traffic Control Team Skills** **1.5 Units**
Leadership skills for aviation professionals, with emphasis on air traffic control team skills.

41429	Th	3:30pm - 6:40pm	Shackelford, S	28B-103
8 Weeks, Week beginning 02/26/2018 ending 04/22/2018				

AIRCRAFT MAINTENANCE TECHNOLOGY

■ **AIRM 97A — Aircraft Powerplant Maintenance Technology: Instrumentation** **3.0 Units**
FAA approved course covering instrumentation and smoke and fire detection and suppression systems.

44245	M	5:30pm - 10:35pm	STAFF	28B-108
and	T	5:30pm - 8:55pm	STAFF	28B-108
and	T	9:05pm - 10:40pm	STAFF	28A-102
and	WThF	5:30pm - 10:35pm	STAFF	28A-102
4 Weeks, Week beginning 02/26/2018 ending 03/25/2018				

■ **AIRM 97B — Aircraft Powerplant Maintenance Technology: Fuel Meter Systems** **3.0 Units**
Reciprocating engine and turbine engine fuels and fuel metering systems. Required for FAA certification.

44246	M	5:30pm - 10:35pm	STAFF	28B-108
and	T	5:30pm - 8:55pm	STAFF	28B-108
and	T	9:05pm - 10:40pm	STAFF	28A-102
and	WThF	5:30pm - 10:35pm	STAFF	28A-102
4 Weeks, Week beginning 03/26/2018 ending 04/22/2018				

■ **AIRM 98A — Aircraft Powerplant Maintenance Technology: Ignition Systems** **3.0 Units**
Reciprocating and turbine engine ignition system theory and maintenance. Required for FAA certification.

44249	M	5:30pm - 10:35pm	STAFF	28B-108
and	T	5:30pm - 8:55pm	STAFF	28B-108
and	T	9:05pm - 10:40pm	STAFF	28A-102
and	WThF	5:30pm - 10:35pm	STAFF	28A-102
4 Weeks, Week beginning 04/23/2018 ending 05/20/2018				

■ **AIRM 98B — Aircraft Powerplant Maintenance Technology: Lubricating Systems** **3.0 Units**
Reciprocating and turbine engine lubricants and lubricating systems. Required for FAA certification.

44248	M	5:30pm - 10:35pm	STAFF	28B-108
and	T	5:30pm - 8:55pm	STAFF	28B-108
and	T	9:05pm - 10:40pm	STAFF	28A-102
and	WThF	5:30pm - 10:35pm	STAFF	28A-102
4 Weeks, Week beginning 05/21/2018 ending 06/17/2018				

AMERICAN LANGUAGE

■ **AMLA 22S — American Language Interpersonal Communication** **2.0 Units**
Enhances ability of non-native speakers to communicate with confidence and accuracy in personal and academic situations.

42305	MW	9:45am - 11:50am	Hill Enriquez, E	66-209
8 Weeks, Week beginning 02/26/2018 ending 04/22/2018				

■ **AMLA 41W — American Language Basic Writing** **4.0 Units**
Basic grammar and writing for non-native speakers.

42292	MTWTh	9:45am - 11:50am	Stokes, N	26A-2610
8 Weeks, Week beginning 02/26/2018 ending 04/22/2018				

■ **AMLA 42W — American Language Intermediate Writing** **4.0 Units**
Intermediate grammar and writing for non-native speakers.

42293	MTWTh	7:30am - 9:35am	Stokes, N	26A-2610
8 Weeks, Week beginning 02/26/2018 ending 04/22/2018				

ANATOMY AND PHYSIOLOGY

■ **ANAT 10A — Introductory Human Anatomy** **4.0 Units**
Macroscopic and microscopic structure of the human body.

43691	TTh	7:00am - 7:50am	Nguyen, K	60-2503
and	T	8:00am - 11:10am	Nguyen, K	11-2312
and	Th	8:00am - 11:10am	Nguyen, K	11-2312
and	F	8:00am - 11:10am	Nguyen, K	60-2503
and	S	8:00am - 9:25am	Nguyen, K	60-2503
8 Weeks, Week beginning 02/26/2018 ending 04/22/2018				
43692	TTh	7:00am - 7:50am	Nguyen, K	60-2503
and	T	8:00am - 11:10am	Nguyen, K	11-2312
and	Th	8:00am - 11:10am	Nguyen, K	11-2312
and	F	8:00am - 11:10am	Nguyen, K	60-2503
and	S	8:00am - 9:25am	Nguyen, K	60-2503
8 Weeks, Week beginning 04/23/2018 ending 06/17/2018				

ART HISTORY

■ **AHIS 1 — Understanding the Visual Arts** **3.0 Units**
Visual art forms and role of art in history, culture; off-campus trips possible. Credit not given for both ARTB 1 and AHIS 1

44089	arrange	6.75 hours	Caldwell, E	ONLINE
8 Weeks, Week beginning 02/26/2018 ending 04/22/2018				

NOTE: CRN 44089 is a Distance Learning Online Class.

Other Course Requirements: Three museum visits are required.
How to Begin Course: Log into Canvas through <http://myportal.mtsac.edu> and click on CRN for your DL course. **NOTE:** Some courses may not be activated until the start of the term. If you cannot locate your DL course in Canvas when the term starts, contact the professor. **On the first day of classes, log into your DL course to show your "attendance" because not doing so could result in your being dropped from the class for non-attendance.**

Professor contact info: Email Professor Caldwell at either: ECaldwell1@mtsac.edu, through Student Detail Schedule or Canvas at MyMt-SAC Portal.

Students must use their Mt. SAC e-mail account and be aware of course commitment and student expectations described at <http://www.mtsac.edu/instruction/learning/distlearn/>

To prepare for a successful online learning experience, see helpful short videos at <http://www.mtsac.edu/distancelearning/quiz/>

44090 arrange 6.75 hours Caldwell, E ONLINE

8 Weeks, Week beginning 04/23/2018 ending 06/17/2018**NOTE:** CRN 44090 is a Distance Learning Online Class.**Other Course Requirements:** Three museum visits are required.**How to Begin Course:** Log into Canvas through <http://myportal.mtsac.edu> and click on CRN for your DL course. **NOTE:** Some courses may not be activated until the start of the term. If you cannot locate your DL course in Canvas when the term starts, contact the professor. **On the first day of classes, log into your DL course to show your "attendance" because not doing so could result in your being dropped from the class for non-attendance.****Professor contact info:** Email Professor Caldwell at either: ECaldwell1@mtsac.edu, through Student Detail Schedule or Canvas at MyMtSAC Portal.**Students must use their Mt. SAC e-mail account and be aware of course commitment and student expectations described at <http://www.mtsac.edu/instruction/learning/distlearn/>**To prepare for a successful online learning experience, see helpful short videos at <http://www.mtsac.edu/distancelearning/quiz/>**■ AHIS 4 — History of Western Art: Prehistoric Through Gothic 3.0 Units**

Western art from Prehistoric through Gothic periods; relationship of visual art forms to each other and to the cultural context.

44100 W 02/28 3:00pm - 4:00pm Hernandez, C 26D-2220
and arrange 6.75 hours Hernandez, C ONLINE**8 Weeks, Week beginning 02/26/2018 ending 04/22/2018****NOTE:** CRN 44100 is a Hybrid Class taught partially online with Scheduled Meetings on Campus.**Course Orientation:** Course orientation scheduled above is mandatory. If student cannot attend orientation, student must contact professor before orientation meeting to avoid being dropped from class.**Other Course Requirements:** One museum visit is required.**How to Begin Course:** Log into Canvas through <http://myportal.mtsac.edu> and click on CRN for your DL course. **NOTE:** Some courses may not be activated until the start of the term. If you cannot locate your DL course in Canvas when the term starts, contact the professor. **On the first day of classes, log into your DL course to show your "attendance" because not doing so could result in your being dropped from the class for non-attendance.****Professor contact info:** Email Professor Hernandez at either: CHernandez@mtsac.edu, through Student Detail Schedule or Canvas at MyMtSAC Portal.**Students must use their Mt. SAC e-mail account and be aware of course commitment and student expectations described at <http://www.mtsac.edu/instruction/learning/distlearn/>**To prepare for a successful online learning experience, see helpful short videos at <http://www.mtsac.edu/distancelearning/quiz/>44101 W 04/25 3:00pm - 4:00pm Hernandez, C 26D-2220
and arrange 6.75 hours Hernandez, C ONLINE**8 Weeks, Week beginning 04/23/2018 ending 06/17/2018****NOTE:** CRN 44101 is a Hybrid Class taught partially online with Scheduled Meetings on Campus.**Course Orientation:** Course orientation scheduled above is mandatory. If student cannot attend orientation, student must contact professor before orientation meeting to avoid being dropped from class.**Other Course Requirements:** One museum visit is required.**How to Begin Course:** Log into Canvas through <http://myportal.mtsac.edu> and click on CRN for your DL course. **NOTE:** Some courses may not be activated until the start of the term. If you cannot locate your DL course in Canvas when the term starts, contact the professor. **On the first day of classes, log into your DL course to show your "attendance" because not doing so could result in your being dropped from the class for non-attendance.****Professor contact info:** Email Professor Hernandez at either: CHernandez@mtsac.edu, through Student Detail Schedule or Canvas at MyMtSAC Portal.**Students must use their Mt. SAC e-mail account and be aware of course commitment and student expectations described at <http://www.mtsac.edu/instruction/learning/distlearn/>**To prepare for a successful online learning experience, see helpful short videos at <http://www.mtsac.edu/distancelearning/quiz/>**■ AHIS 5 — History of Western Art: Renaissance Through Modern 3.0 Units**

History of Renaissance through Modern art in cultural context. Off campus assignments may be required.

44105 M 02/26 3:00pm - 4:00pm Hight, D 26D-2220
and arrange 6.75 hours Hight, D ONLINE**8 Weeks, Week beginning 02/26/2018 ending 04/22/2018****NOTE:** CRN 44105 is a Hybrid Class taught partially online with a Scheduled Meeting on Campus.**Course Orientation:** Course orientation scheduled above is mandatory. If student cannot attend orientation, student must contact professor before orientation meeting to avoid being dropped from class.**Other Course Requirements:** One museum visit is required.**How to Begin Course:** Log into Canvas through <http://myportal.mtsac.edu> and click on CRN for your DL course. **NOTE:** Some courses may not be activated until the start of the term. If you cannot locate your DL course in Canvas when the term starts, contact the professor. **On the first day of classes, log into your DL course to show your "attendance" because not doing so could result in your being dropped from the class for non-attendance.****Professor contact info:** Email Professor Hight at either: DHight@mtsac.edu, through Student Detail Schedule or Canvas at MyMtSAC Portal.**Students must use their Mt. SAC e-mail account and be aware of course commitment and student expectations described at <http://www.mtsac.edu/instruction/learning/distlearn/>**To prepare for a successful online learning experience, see helpful short videos at <http://www.mtsac.edu/distancelearning/quiz/>44106 M 04/23 3:00pm - 4:00pm Hight, D 26D-2220
and arrange 6.75 hours Hight, D ONLINE**8 Weeks, Week beginning 04/23/2018 ending 06/17/2018****NOTE:** CRN 44106 is a Hybrid Class taught partially online with a Scheduled Meeting on Campus.**Course Orientation:** Course orientation scheduled above is mandatory. If student cannot attend orientation, student must contact professor before orientation meeting to avoid being dropped from class.**Other Course Requirements:** One museum visit is required.**How to Begin Course:** Log into Canvas through <http://myportal.mtsac.edu> and click on CRN for your DL course. **NOTE:** Some courses may not be activated until the start of the term. If you cannot locate your DL course in Canvas when the term starts, contact the professor. **On the first day of classes, log into your DL course to show your "attendance" because not doing so could result in your being dropped from the class for non-attendance.****Professor contact info:** Email Professor Hight at either: DHight@mtsac.edu, through Student Detail Schedule or Canvas at MyMtSAC Portal.**Students must use their Mt. SAC e-mail account and be aware of course commitment and student expectations described at <http://www.mtsac.edu/instruction/learning/distlearn/>**To prepare for a successful online learning experience, see helpful short videos at <http://www.mtsac.edu/distancelearning/quiz/>**BIOLOGY****■ BIOL 6 — Humans and the Environment 3.0 Units**

Ecological concepts to aid understanding our environmental crisis.

41750 MW 9:45am - 12:55pm Kakiba-Russell, K 7-1205
16 Weeks, Week beginning 02/26/2018 ending 04/22/201841751 MW 9:45am - 12:55pm Kakiba-Russell, K 7-1205
16 Weeks, Week beginning 04/23/2018 ending 06/17/2018

BUSINESS: ACCOUNTING

■ **BUSA 7 — Principles of Accounting - Financial** 5.0 Units
Financial accounting required of Business Administration and Accounting majors.

41175 F 7:00pm - 10:10pm Hoekstra, T 79-3250
and arrange 8.25 hours Hoekstra, T ONLINE
8 Weeks, Week beginning 02/26/2018 ending 04/22/2018

NOTE: CRN 41175 is a Hybrid Class taught partially online with scheduled meetings on campus.

How to Begin Course: Log into Canvas through <http://myportal.mtsac.edu> and click on CRN for your DL course. If cannot locate your DL course in Canvas, contact the professor. On the first day of classes, log into your DL course to show your "attendance" because not doing so could result in your being dropped from the class for non-attendance.

Professor contact info: Email Professor Hoekstra at either: THoekstra@mtsac.edu, through Student Detail Schedule or Canvas at MyMtSAC Portal.

Students must use their Mt. SAC e-mail account and be aware of course commitment and student expectations described at <http://www.mtsac.edu/instruction/learning/distlearn/>

To prepare for a successful online learning experience, see helpful short videos at <http://www.mtsac.edu/distancelearning/quiz/>

■ **BUSA 8 — Principles of Accounting - Managerial** 5.0 Units
Managerial accounting concepts and principles. Provides the accounting tools and methods needed for decision making in business.

41176 F 7:00pm - 10:10pm Hoekstra, T 79-3250
and arrange 7.75 hours Hoekstra, T ONLINE
8 Weeks, Week beginning 04/23/2018 ending 06/17/2018

NOTE: CRN 41176 is a Hybrid Class taught partially online with scheduled meetings on campus.

How to Begin Course: Log into Canvas through <http://myportal.mtsac.edu> and click on CRN for your DL course. If cannot locate your DL course in Canvas, contact the professor. On the first day of classes, log into your DL course to show your "attendance" because not doing so could result in your being dropped from the class for non-attendance.

Professor contact info: Email Professor Hoekstra at either: THoekstra@mtsac.edu, through Student Detail Schedule or Canvas at MyMtSAC Portal.

Students must use their Mt. SAC e-mail account and be aware of course commitment and student expectations described at <http://www.mtsac.edu/instruction/learning/distlearn/>

To prepare for a successful online learning experience, see helpful short videos at <http://www.mtsac.edu/distancelearning/quiz/>

■ **BUSA 75 — Using Microcomputers in Financial Accounting** 1.0 Unit
Accounting concepts utilizing QuickBooks, a general-ledger software program. Computer processing of accounting transactions.

41155 M 4:30pm - 6:35pm Valdes, S 79-3270
8 Weeks, Week beginning 02/26/2018 ending 04/22/2018

NOTE: QuickBooks Accounting used for this course.

40892 Th 5:30pm - 7:35pm Quintero, H 79-3270
8 Weeks, Week beginning 02/26/2018 ending 04/22/2018

NOTE: QuickBooks Accounting used for this course.

■ **BUSA 76 — Using Microcomputers in Managerial Accounting** 1.0 Unit

Analysis of financial data and preparation of managerial accounting reports using Excel software.

41156 M 9:45am - 11:50am Bates, B 79-3270
8 Weeks, Week beginning 02/26/2018 ending 04/22/2018

40893 Th 5:30pm - 7:35pm Quintero, H 79-3270
8 Weeks, Week beginning 04/23/2018 ending 06/17/2018

BUSINESS: ECONOMICS

■ **BUSC 1A — Principles of Economics - Macroeconomics** 3.0 Units
Principles of aggregate economic analysis.

40905 TTh 7:00pm - 10:10pm Baez, M 78-3180
8 Weeks, Week beginning 02/26/2018 ending 04/22/2018

■ **BUSC 1B — Principles of Economics - Microeconomics** 3.0 Units

41161 TTh 7:00pm - 10:10pm Baez, M 78-3180
8 Weeks, Week beginning 04/23/2018 ending 06/17/2018

BUSINESS: LAW

■ **BUSL 18 — Business Law** 3.0 Units
Business law: court procedures, ethics, torts, crimes, contract law, and sales of goods under the Uniform Commercial Code.

41226 arrange 6.8 hours Mc Kee, C ONLINE
8 Weeks, Week beginning 02/26/2018 ending 04/22/2018

NOTE: CRN 41226 is a Distance Learning Online Class.

Course Orientation: On campus orientation (optional) Monday, February 26 from 5:45-6:45 PM in 18-17. If a student cannot attend orientation meeting, student must contact professor before orientation meeting to avoid being dropped from class.

How to Begin Course: Log into Canvas through the eLearning Tools tab in the Mt. SAC portal at my.mtsac.edu. Then click on the Canvas link and then click on CRN for your DL course. **NOTE:** Some courses may not be activated until the start of the term. If you cannot locate your DL course in Canvas when the term starts, contact the professor. **On the first day of classes, log into your DL course to show your "attendance" because not doing so could result in your being dropped from the class for non-attendance.**

Professor contact info: Email Professor McKee at either: CMcKee@mtsac.edu, through Student Detail Schedule or Canvas at MyMtSAC Portal.

Students must use their Mt. SAC e-mail account and be aware of course commitment and student expectations described at <http://www.mtsac.edu/instruction/learning/distlearn/>

To prepare for a successful online learning experience, see helpful short videos at <http://www.mtsac.edu/distancelearning/quiz/>

■ **BUSL 19 — Advanced Business Law** 3.0 Units
Principles of business law emphasizing commercial paper, agency, business entities, bankruptcy, trade, and real property.

41216 arrange 6.8 hours Wood, A ONLINE
8 Weeks, Week beginning 04/23/2018 ending 06/17/2018

NOTE: CRN 41216 is a Distance Learning Online Class.

Course Orientation: There is no on campus orientation for this course. You must log in to Canvas and complete the Syllabus Quiz to show your "attendance" on the first day.

How to Begin Course: Log into Canvas through <http://myportal.mtsac.edu> and click on CRN for your DL course. **NOTE:** Some courses may not be activated until the start of the term. If you cannot locate your DL course in Canvas when the term starts, contact the professor. **On the first day of classes, log into your DL course to show your "attendance" because not doing so could result in your being dropped from the class for non-attendance.. NOTE:** Check your campus email account for an email from Professor Wood by the first day of class.

Professor contact info: Email Professor Wood at either: AWood10@mtsac.edu, through Student Detail Schedule or Canvas at MyMtSAC Portal.

Students must use their Mt. SAC e-mail account and be aware of course commitment and student expectations described at <http://www.mtsac.edu/instruction/learning/distlearn/>

To prepare for a successful online learning experience, see helpful short videos at <http://www.mtsac.edu/distancelearning/quiz/>

CHILD DEVELOPMENT

■ **CHLD 6 — Introduction to Child Development Curriculum** 3.0 Units
Curriculum designs, content areas and environments appropriate for children birth-8 years old. TB test and observations required.
40981 TTh 11:30am - 2:40pm Moore, R 73-1810
8 Weeks, Week beginning 02/26/2018 ending 04/22/2018

■ **CHLD 10 — Child Growth and Lifespan Development** 3.0 Units
Human lifespan and developmental influences. Out-of-class observations and interviews. TB test required.
44353 TTh 8:00am - 11:10am Fernandez, M 73-1810
8 Weeks, Week beginning 04/23/2018 ending 06/17/2018

■ **CHLD 75 — Supervising Adults in Early Childhood Settings** 2.0 Units
Methods and principles of working with and supervising adults in the early childhood setting.

41022 W 6:30pm - 9:50pm Medrano, M 73-1860
10 Weeks, Week beginning 04/09/2018 ending 06/17/2018

■ **CHLD 84 — Guidance and Discipline in Child Development Settings** 1.0 Unit
Problem solving approach to guidance and discipline of children in child development settings.

41023 W 6:30pm - 9:40pm Hernandez, G 73-1860
6 Weeks, Week beginning 02/26/2018 ending 04/08/2018

COMPUTER INFORMATION SYSTEMS: PROGRAMMING

■ **CISP 31 — Programming in C++** 3.0 Units
Object-oriented programming in C++ including design, documentation, and debugging. Student must take CISP 31L concurrently.

41111 MW 8:00am - 9:30am Degtyareva, A 78-2110
and arrange 3.15 hours Degtyareva, A ONLINE
8 Weeks, Week beginning 02/26/2018 ending 04/22/2018

NOTE: CRN 41111 is a Hybrid Class taught partially online with scheduled meetings on campus and is linked to CISP31L (CRN 41114). If you are interested in enrolling in these courses, you must enter both CRNs (41111 and 41114) to register.

How to Begin Course: Log into Canvas through the eLearning Tools tab in the Mt. SAC portal at my.mtsac.edu. Then click on the Canvas link and then click on CRN for your DL course. **NOTE:** Some courses may not be activated until the start of the term. If you cannot locate your DL course in Canvas when the term starts, contact the professor. **On the first day of classes, log into your DL course to show your "attendance" because not doing so could result in your being dropped from the class for non-attendance.**

Contact info: Email Professor Degtyareva at either: adegtyareva@mtsac.edu, through Student Detail Schedule or Canvas at MyMtSAC Portal.

Students must use their Mt. SAC e-mail account and be aware of course commitment and student expectations described at <http://www.mtsac.edu/instruction/learning/distlearn/>

To prepare for a successful online learning experience, see helpful short videos <http://www.mtsac.edu/distancelearning/quiz/>

41112 T 1:40pm - 5:00pm Degtyareva, A 78-2110
and arrange 3.25 hours Degtyareva, A ONLINE
8 Weeks, Week beginning 02/26/2018 ending 04/22/2018

NOTE: CRN 41112 is a Hybrid Class taught partially online with scheduled meetings on campus and is linked to CISP31L (CRN 41115). If you are interested in enrolling in these courses, you must enter both CRNs (41112 and 41115) to register.

How to Begin Course: Log into Canvas through the eLearning Tools tab in the Mt. SAC portal at my.mtsac.edu. Then click on the Canvas link and then click on CRN for your DL course. **NOTE:** Some courses may not be activated until the start of the term. If you cannot locate your DL course in Canvas when the term starts, contact the professor. **On the first day of classes, log into your DL course to show your "attendance" because not doing so could result in your being dropped from the class for non-attendance.**

Contact info: Email Professor Degtyareva at either: adegtyareva@mtsac.edu, through Student Detail Schedule or Canvas at MyMtSAC Portal.

Students must use their Mt. SAC e-mail account and be aware of course commitment and student expectations described at <http://www.mtsac.edu/instruction/learning/distlearn/>

To prepare for a successful online learning experience, see helpful short videos <http://www.mtsac.edu/distancelearning/quiz/>

41113 TTh 7:00pm - 8:30pm Degtyareva, A 78-2110
and arrange 3.6 hours Degtyareva, A ONLINE
8 Weeks, Week beginning 02/26/2018 ending 04/22/2018

NOTE: CRN 41113 is a Hybrid Class taught partially online with scheduled meetings on campus and is linked to CISP31L (CRN 41116). If you are interested in enrolling in these courses, you must enter both CRNs (41113 and 41116) to register.

How to Begin Course: Log into Canvas through the eLearning Tools tab in the Mt. SAC portal at my.mtsac.edu. Then click on the Canvas link and then click on CRN for your DL course. **NOTE:** Some courses may not be activated until the start of the term. If you cannot locate your DL course in Canvas when the term starts, contact the professor. **On the first day of classes, log into your DL course to show your "attendance" because not doing so could result in your being dropped from the class for non-attendance.**

Contact info: Email Professor Degtyareva at either: adegtyareva@mtsac.edu, through Student Detail Schedule or Canvas at MyMtSAC Portal.

Students must use their Mt. SAC e-mail account and be aware of course commitment and student expectations described at <http://www.mtsac.edu/instruction/learning/distlearn/>

To prepare for a successful online learning experience, see helpful short videos <http://www.mtsac.edu/distancelearning/quiz/>

■ **CISP 31L — Programming in C++ Laboratory** .5 Unit
Lab for object-oriented programming in C++ including design, documentation, and debugging. Student must take CISP 31 concurrently.

41114 MW 9:45am - 11:15am Degtyareva, A 78-2110
8 Weeks, Week beginning 02/26/2018 ending 04/22/2018

NOTE: CISP31L (CRN 41114) is linked to CISP31(CRN 41111). If you are interested in enrolling in these courses, you must enter both CRN's (41114 and 41111) to register.

41115 TTh 5:15pm - 6:40pm Degtyareva, A 78-2110
8 Weeks, Week beginning 02/26/2018 ending 04/22/2018

NOTE: CISP31L (CRN 41115) is linked to CISP31(CRN 41112). If you are interested in enrolling in these courses, you must enter both CRN's (41115 and 41112) to register.

41116 TTh 8:40pm - 10:10pm Degtyareva, A 78-2110
8 Weeks, Week beginning 02/26/2018 ending 04/22/2018

NOTE: CISP31L (CRN 41116) is linked to CISP31(CRN 41113). If you are interested in enrolling in these courses, you must enter both CRN's (41116 and 41113) to register.

■ **CISP 34 — Advanced C++ Programming** **3.0 Units**
Object-oriented programming in C++. Covers data structures, GUI, database, web services. Student must take CISP 34L concurrently.

41117 TTh 7:00pm - 8:30pm Degtyareva, A 78-2110
and arrange 3.15 hours Degtyareva, A
8 Weeks, Week beginning 04/23/2018 ending 06/17/2018

NOTE: CRN 41117 is a Hybrid Class taught partially online with scheduled meetings on campus.

How to Begin Course: Log into Canvas through the eLearning Tools tab in the Mt. SAC portal at my.mtsac.edu. Then click on the Canvas link and then click on CRN for your DL course. **NOTE:** Some courses may not be activated until the start of the term. If you cannot locate your DL course in Canvas when the term starts, contact the professor. **On the first day of classes, log into your DL course to show your "attendance" because not doing so could result in your being dropped from the class for non-attendance.**

Contact info: Email Professor Degtyareva at either: adegtyareva@mtsac.edu, through Student Detail Schedule or Canvas at MyMtSAC Portal.

Students must use their Mt. SAC e-mail account and be aware of course commitment and student expectations described at <http://www.mtsac.edu/instruction/learning/distlearn/>

To prepare for a successful online learning experience, see helpful short videos <http://www.mtsac.edu/distancelearning/quiz/>

■ **CISP 34L — Advanced C++ Programming Laboratory** **.5 Unit**
C++ Object-oriented programming lab. Covers data structures, GUI, database, web services. Student must take CISP 34 concurrently.

41118 TTh 8:45pm - 10:10pm Degtyareva, A 78-2110
8 Weeks, Week beginning 04/23/2018 ending 06/17/2018

COUNSELING

■ **COUN 1 — Introduction to College** **1.0 Unit**
Higher education and the college experience including educational decision-making and educational planning.

44233 M 2:15pm - 4:20pm Gutierrez, D 12-1020

8 Weeks, Week beginning 02/26/2018 ending 04/22/2018
44376 T 2:15pm - 4:20pm Cuevas-Arella, A 12-1020
8 Weeks, Week beginning 02/26/2018 ending 04/22/2018

44231 Th 2:15pm - 4:20pm Santacruz, R 12-1020

8 Weeks, Week beginning 02/26/2018 ending 04/22/2018
44232 W 4:30pm - 6:35pm Mestas, S 12-1020
8 Weeks, Week beginning 02/26/2018 ending 04/22/2018

■ **COUN 5 — Career and Life Planning** **3.0 Units**
Explore and evaluate career options using a systematic approach to self-exploration, career, and life planning.

44240 M 02/26 7:00pm - 10:10pm Mbuthi, S 12-1060
and arrange 6.75 hours Mbuthi, S ONLINE
8 Weeks, Week beginning 02/26/2018 ending 04/22/2018

NOTE: CRN 44240 is a Hybrid Class taught partially online with a Mandatory Scheduled Meeting on campus.

Course orientation scheduled above is mandatory. If student cannot attend orientation, student must contact professor before orientation meeting to avoid being dropped from class.

How to Begin Course: Log into Canvas through <http://myportal.mtsac.edu> and click on CRN for your DL course. **NOTE:** Some courses may not be activated until the start of the term. If you cannot locate your DL course in Canvas when the term starts, contact the professor. **On the first day of class, log into your DL course to show your "attendance" because not doing so could result in you being dropped from the class for non-attendance.**

Professor contact info: Email Professor Mbuthi at either: smbuthi@mtsac.edu, through Student Detail Schedule or Canvas at MyMtSAC Portal.

Students must use their Mt. SAC e-mail account and be aware of course commitment and student expectations described at <http://www.mtsac.edu/instruction/distlearn/>

To prepare for a successful online learning experience, see helpful short videos <http://www.mtsac.edu/distancelearning/quiz/>.

Modern computer with internet connection required.

44241 TW 7:00pm - 9:05pm Mbuthi, S 12-1060
and arrange 2.66 hours Mbuthi, S ONLINE
8 Weeks, Week beginning 02/26/2018 ending 04/22/2018

NOTE: CRN 44241 is a Hybrid Class taught partially online with Mandatory Scheduled Meetings on campus.

How to Begin Course: Log into Canvas through <http://myportal.mtsac.edu> and click on CRN for your DL course. **NOTE:** Some courses may not be activated until the start of the term. If you cannot locate your DL course in Canvas when the term starts, contact the professor. **On the first day of class, log into your DL course to show your "attendance" because not doing so could result in you being dropped from the class for non-attendance.**

Professor contact info: Email Professor Mbuthi at either: smbuthi@mtsac.edu, through Student Detail Schedule or Canvas at MyMtSAC Portal.

Students must use their Mt. SAC e-mail account and be aware of course commitment and student expectations described at <http://www.mtsac.edu/instruction/distlearn/>

To prepare for a successful online learning experience, see helpful short videos <http://www.mtsac.edu/distancelearning/quiz/>.

Modern computer with internet connection required.

ELECTRONICS

■ **ELEC 50A — Electronic Circuits - Direct Current (DC)** **4.0 Units**
DC electrical circuits and their applications. Students seeking a survey course should take ELEC 10, rather than ELEC 50A or 50B.

41356 MW 8:00am - 11:10am Denny, J 28B-405
and MW 11:30am - 2:40pm Denny, J 28B-405
8 Weeks, Week beginning 02/26/2018 ending 04/22/2018

41357 TTh 8:00am - 11:10am Hymer, J 28B-401
and TTh 11:30am - 2:40pm Hymer, J 28B-401
8 Weeks, Week beginning 02/26/2018 ending 04/22/2018

■ **ELEC 50B — Electronic Circuits (AC)** **4.0 Units**
Alternating Current (AC) electrical circuits and their applications.

41358 MW 8:00am - 11:10am Denny, J 28B-405
and MW 11:30am - 2:40pm Denny, J 28B-405
8 Weeks, Week beginning 04/23/2018 ending 06/17/2018

41359 TTh 8:00am - 11:10am Hymer, J 28B-401
and TTh 11:30am - 2:40pm Hymer, J 28B-401
8 Weeks, Week beginning 04/23/2018 ending 06/17/2018

EMERGENCY MEDICAL SERVICE

■ **EMS 10 — Anatomy and Physiology for Paramedics** **3.0 Units**
Gross anatomy and physiology of the human body, with applications to paramedic practices.

44726 MTWThF 8:00am - 11:50am Mah, D 28B
4 Weeks, Week beginning 02/26/2018 ending 03/18/2018

■ **EMS 20 — Emergency Cardiac Care for Paramedics** **1.5 Units**
Certifies students in Pediatric Advanced Life Support and Advanced Cardiac Life Support.

44731 MTWThF 8:00am - 10:05am STAFF 28B-207
and MTWThF 10:15am - 2:00pm STAFF 28B-209
2 Weeks, Week beginning 06/04/2018 ending 06/17/2018

■ **EMS 30 — Pharmacology for Paramedics** **3.0 Units**
Paramedic drugs with emphasis on dosages, routes of administration, expected therapeutic outcomes and possible adverse reactions.

44727 MTWThF 12:50pm - 2:10pm Wilson, C 28B-207
and MTWThF 2:20pm - 4:30pm Wilson, C 28B-209
6 Weeks, Week beginning 02/26/2018 ending 04/01/2018

■ **EMS 40 — Cardiology for Paramedics** **3.0 Units**
Normal, abnormal, and diseased heart, assessments, assessment tools, interpretation of dysrhythmias, and paramedic interventions.

44728 MTWThF 8:00am - 11:35am Wilson, C 28B
3 Weeks, Week beginning 03/19/2018 ending 04/08/2018

■ **EMS 60 — EMS Theory for Paramedics** **8.5 Units**
 Paramedic theories, principles and practices, assessment and treatment of pathologic processes, and mechanisms of injury.
 44730 MTWThF 8:00am - 11:50am Mah, D TBA
4 Weeks, Week beginning 04/09/2018 ending 06/03/2018

ENGLISH: COMPOSITION

■ **ENGL 1A — Freshman Composition** **4.0 Units**
 Develops expository and argumentative essay and research paper skills. Emphasizes critical reading of academic material.
 42630 MTWTh 7:30am - 9:35am Hernandez, L 26A-3690
8 Weeks, Week beginning 02/26/2018 ending 04/22/2018

NOTE: CRN 42630 is linked to CRN 42902 and is a part of the Pathways Program. This course is continuing from the Winter term and seats are reserved for students already in the program. Any additional seats will be open for registration to any eligible student. This course is a part of English Cohort #8. If you have any questions please email pathways@mtsac.edu or call (909) 274-5703.

42659 MTWTh 7:30am - 9:35am Piluso, R 18-1
8 Weeks, Week beginning 02/26/2018 ending 04/22/2018

NOTE: CRN 42659 is linked to CRN 42675 and is a part of the Pathways Program. This course is continuing from the Winter term and seats are reserved for students already in the program. Any additional seats will be open for registration to any eligible student. This course is a part of English Cohort #7. If you have any questions please email pathways@mtsac.edu or call (909) 274-5703.

42789 MTWTh 7:30am - 9:35am Tolliver, T 26D-2210
8 Weeks, Week beginning 04/23/2018 ending 06/17/2018

NOTE: CRN 42789 is linked to CRN 42718 and is a part of the Pathways Program. This course is continuing from the Winter term and seats are reserved for students already in the program. Any additional seats will be open for registration to any eligible student. This course is a part of English Cohort #9. If you have any questions please email pathways@mtsac.edu or call (909) 274-5703.

42847 MTWTh 9:45am - 11:50am Piluso, R 18-1
8 Weeks, Week beginning 02/26/2018 ending 04/22/2018

42788 TTh 9:45am - 11:50am Loera-Ramirez, D 26D-G220
 and arrange 4.5 hours Loera-Ramirez, D ONLINE
8 Weeks, Week beginning 04/23/2018 ending 06/17/2018

NOTE: CRN 42788 is a Hybrid Class taught partially online with Scheduled Meetings on Campus.

How to Begin Course: Log into Canvas through <http://myportal.mtsac.edu> and click on CRN for your DL course. **NOTE:** Some courses may not be activated until the start of the term. If you cannot locate your DL course in Canvas when the term starts, contact the professor. **On the first day of classes, log into your DL course to show your "attendance" because not doing so could result in your being dropped from the class for non-attendance.**

Professor contact info: Email Professor Loera-Ramirez at either: DLoera@mtsac.edu, through Student Detail Schedule or Canvas at MyMtSAC Portal.

Students must use their Mt. SAC e-mail account and be aware of course commitment and student expectations described at <http://www.mtsac.edu/instruction/learning/distlearn/>

To prepare for a successful online learning experience, see helpful short videos at <http://www.mtsac.edu/distancelearning/quiz/>

42792 TTh 12:00pm - 2:05pm Loera-Ramirez, D 26D-G220
 and arrange 4.5 hours Loera-Ramirez, D ONLINE
8 Weeks, Week beginning 04/23/2018 ending 06/17/2018

■ **ENGL 1C — Critical Thinking and Writing** **4.0 Units**
 Develops critical thinking, reading, and writing skills. Focuses on logical analysis and argumentative writing.

42675 MTWTh 7:30am - 9:35am Piluso, R 18-1
8 Weeks, Week beginning 04/23/2018 ending 06/17/2018

NOTE: CRN 42675 is linked to CRN 42659 and is a part of the Pathways Program. This course is continuing from the Winter term and seats are reserved for students already in the program. Any additional seats will be open for registration to any eligible student. This course is a part of English Cohort #7. If you have any questions please email pathways@mtsac.edu or call (909) 274-5703.

42902 MTWTh 7:30am - 9:35am Hernandez, L 26A-3690
8 Weeks, Week beginning 04/23/2018 ending 06/17/2018

NOTE: CRN 42902 is linked to CRN 42630 and is a part of the Pathways Program. This course is continuing from the Winter term and seats are reserved for students already in the program. Any additional seats will be open for registration to any eligible student. This course is a part of English Cohort #8. If you have any questions please email pathways@mtsac.edu or call (909) 274-5703.

42684 MTWTh 9:45am - 11:50am Piluso, R 18-1
8 Weeks, Week beginning 04/23/2018 ending 06/17/2018
22 Weeks, Week beginning 01/02/2018 ending 05/31/2018

■ **ENGL 64 — Writing Effective Sentences** **1.0 Unit**
 Improves sentence skills through application of sentence elements and identification and correction of common sentence problems.

44151 TTh 2:30pm - 3:35pm Farve, D 26A-3891
8 Weeks, Week beginning 02/26/2018 ending 04/22/2018

NOTE: CRN 44151 above is linked to ENGL 66 (CRN 44152).

■ **ENGL 66 — Paragraph Writing** **1.0 Unit**
 Analysis and writing of paragraphs. Through the process of writing, the student learns to state and support a topic idea.

44152 TTh 2:30pm - 3:35pm Farve, D 26A-3891
8 Weeks, Week beginning 04/23/2018 ending 06/17/2018

NOTE: CRN 44152 above is linked to ENGL 64 (CRN 44151).

■ **ENGL 67 — Writing Fundamentals** **4.0 Units**
 Emphasizes sentence, outlining, summary, paragraph and essay skills, and critical thinking through combining reading and writing.

42692 TTh 7:30am - 9:35am Estrada, M 26A-3871
16 Weeks, Week beginning 02/26/2018 ending 06/17/2018

42697 MTWTh 9:45am - 11:50am Frahs, P 26A-3811
8 Weeks, Week beginning 02/26/2018 ending 04/22/2018

NOTE: CRN 42697 above is designed for students in the Bridge Program. Attendance at an information session and special approval are needed to enroll in this learning community. This course is linked to ENGL 68 (CRN 42729) and COUN 2 (CRN 44290). For more information, please contact (909)274-5392.

42709 MTWTh 12:00pm - 2:05pm Frahs, P 26A-3811
8 Weeks, Week beginning 02/26/2018 ending 04/22/2018

■ ENGL 68 — Preparation for College Writing 4.0 Units

Development of the academic essay based on critical reading of texts.

42718 MTWTh 7:30am - 9:35am Tolliver, T 26D-2210

8 Weeks, Week beginning 02/26/2018 ending 04/22/2018

NOTE: CRN 42718 is linked to CRN 42789 and is a part of the Pathways Program. This course is continuing from the Winter term and seats are reserved for students already in the program. Any additional seats will be open for registration to any eligible student. This course is a part of English Cohort #9. If you have any questions please email pathways@mtsac.edu or call (909) 274-5703.

42729 MTWTh 9:45am - 11:50am Frahs, P 26A-3811

8 Weeks, Week beginning 04/23/2018 ending 06/17/2018

NOTE: CRN 42729 above is designed for students in the Bridge Program. Attendance at an information session and special approval are needed to enroll in this learning community. This course is linked to ENGL 67 (CRN 42697) and COUN 2 (CRN 44290). For more information, please contact (909)274-5392.

42785 TTh 9:45am - 11:50am Loera-Ramirez, D 26D-G220

and arrange 4.5 hours Loera-Ramirez, D ONLINE

8 Weeks, Week beginning 02/26/2018 ending 04/22/2018

NOTE: CRN 42785 is a Hybrid Class taught partially online with Scheduled Meetings on Campus.

How to Begin Course: Log into Canvas through <http://myportal.mtsac.edu> and click on CRN for your DL course. **NOTE:** Some courses may not be activated until the start of the term. If you cannot locate your DL course in Canvas when the term starts, contact the professor. **On the first day of classes, log into your DL course to show your "attendance" because not doing so could result in your being dropped from the class for non-attendance.**

Professor contact info: Email Professor Loera-Ramirez at either: DLoera@mtsac.edu, through Student Detail Schedule or Canvas at MyMtSAC Portal.

Students must use their Mt. SAC e-mail account and be aware of course commitment and student expectations described at <http://www.mtsac.edu/instruction/learning/distlearn/>

To prepare for a successful online learning experience, see helpful short videos at <http://www.mtsac.edu/distancelearning/quiz/>

42738 MTWTh 12:00pm - 2:05pm Frahs, P 26A-3811

8 Weeks, Week beginning 04/23/2018 ending 06/17/2018

42787 TTh 12:00pm - 2:05pm Loera-Ramirez, D 26D-G220

and arrange 4.5 hours Loera-Ramirez, D ONLINE

8 Weeks, Week beginning 02/26/2018 ending 04/22/2018

NOTE: CRN 42787 is a Hybrid Class taught partially online with Scheduled Meetings on Campus.

How to Begin Course: Log into Canvas through <http://myportal.mtsac.edu> and click on CRN for your DL course. **NOTE:** Some courses may not be activated until the start of the term. If you cannot locate your DL course in Canvas when the term starts, contact the professor. **On the first day of classes, log into your DL course to show your "attendance" because not doing so could result in your being dropped from the class for non-attendance.**

Professor contact info: Email Professor Loera-Ramirez at either: DLoera@mtsac.edu, through Student Detail Schedule or Canvas at MyMtSAC Portal.

Students must use their Mt. SAC e-mail account and be aware of course commitment and student expectations described at <http://www.mtsac.edu/instruction/learning/distlearn/>

To prepare for a successful online learning experience, see helpful short videos at <http://www.mtsac.edu/distancelearning/quiz/>

FIRE TECHNOLOGY**■ FIRE 12 — Wildland Fire Control 4.5 Units**

Addresses wildland fire behavior, safety, strategy, tactics, and operations in the wildland urban interface. Field trip required.

41369 S 8:00am - 11:50am Burrill, B 28B-210

and S 1:00pm - 3:15pm Burrill, B 28B-210

and arrange 1.4 hours Burrill, B

10 Weeks, Week beginning 02/26/2018 ending 05/06/2018**■ FIRE 86 — Basic Fire Academy 14.5 Units**

Standard fire department apparatus and equipment, salvage covers and fire extinguishment techniques.

41381 arrange 9 hours Shull, S CVIFD

and arrange 25.53 hours Hirsch, J CVIFD

14 Weeks, Week beginning 02/26/2018 ending 06/03/2018**■ FIRE 93 — Firefighter 1 Skills Review and Testing 1.0 Unit**

Review of skills learned in the basic fire academy, in conjunction with the National Firefighter 1 Certification exam.

41561 arrange 40.00 hours Hirsch, J 28B

1 Weeks, Week beginning 06/04/2018 ending 06/10/2018**GEOGRAPHY****■ GEOG 2 — Human Geography 3.0 Units**

Human geography with emphasis on critical areas of inquiry, research, and the interconnections of place and process.

42457 arrange 6.75 hours Lobb, E ONLINE

8 Weeks, Week beginning 02/26/2018 ending 04/22/2018

NOTE: CRN 42457 is a Distance Learning Online Class.

How to Begin Course: Log into Canvas through <http://myportal.mtsac.edu> and click on CRN for your DL course. **NOTE:** Some courses may not be activated until the start of the term. If you cannot locate your DL course in Canvas when the term starts, contact the professor. **On the first day of classes, log into your DL course to show your "attendance" because not doing so could result in your being dropped from the class for non-attendance.**

Professor contact info: Email Professor Lobb at either: ELobb@mtsac.edu, through Student Detail Schedule or Canvas at MyMtSAC Portal.

Students must use their Mt. SAC e-mail account and be aware of course commitment and student expectations described at <http://www.mtsac.edu/instruction/learning/distlearn/>

To prepare for a successful online learning experience, see helpful short videos at <http://www.mtsac.edu/distancelearning/quiz/>

HOSPITALITY AND RESTAURANT MANAGEMENT**■ HRM 51 — Introduction to Hospitality 3.0 Units**

Hospitality industry segments and types of operations with an emphasis on career opportunities.

44156 arrange 6.8 hours Doonan, S ONLINE

8 Weeks, Week beginning 02/26/2018 ending 04/22/2018

NOTE: CRN 44156 is a Distance Learning Online Class. **Field trip required.**

How to Begin Course: Log into Canvas through the eLearning Tools tab in the Mt. SAC portal at my.mtsac.edu. Then click on the Canvas link and then click on CRN for your DL course. **NOTE:** Some courses may not be activated until the start of the term. If you cannot locate your DL course in Canvas when the term starts, contact the professor.

Professor contact info: Email Professor Doonan at either: SDoonan@mtsac.edu, through Student Detail Schedule or Canvas at MyMtSAC Portal.

Students must use their Mt. SAC e-mail account and be aware of course commitment and student expectations described at <http://www.mtsac.edu/instruction/learning/distlearn/>

■ HRM 52 — Food Safety and Sanitation 1.5 Units

Principles of safety and sanitation in the food service industry.

41027 M 8:00am - 11:10am Chavez, S 78-1100
8 Weeks, Week beginning 02/26/2018 ending 04/22/2018**NOTE: CRN 41027-** This course requires the passing of the Food Manager Exam to receive credit. Exam date: Monday, April 16 from 8:00-11:00am in 78-2140.41255 arrange 3.4 hours STAFF ONLINE
8 Weeks, Week beginning 04/23/2018 ending 06/17/2018**NOTE: CRN 41255** is a Distance Learning Online Class.**NOTE: This course requires the passing of the Food Manager Exam to receive credit. Exam date: Monday, 06/11 from 8:00 am -11:00 am in 17-13.****How to Begin Course:** Log into Canvas through the eLearning Tools tab in the Mt. SAC portal at my.mtsac.edu. Then click on the Canvas link and then click on CRN for your DL course. **NOTE:** Some courses may not be activated until the start of the term. If you cannot locate your DL course in Canvas when the term starts, contact the professor.**Professor contact info:** Email Professor STAFF at either: STAFF@mtsac.edu, through Student Detail Schedule or Canvas at MyMtSAC Portal.**Students must use their Mt. SAC e-mail account and be aware of course commitment and student expectations described at <http://www.mtsac.edu/instruction/learning/distlearn/>**41256 arrange 3.4 hours Doonan, S ONLINE
8 Weeks, Week beginning 04/23/2018 ending 06/17/2018**NOTE: CRN 41256 is restricted** to students who have applied and been accepted into the Culinary Arts Cohort.**Effective Mon., 2/5 @ 12:30 PM, this section will be OPENED TO ALL students.**

CRN 41256 is a Distance Learning Online Class.

NOTE: This course requires the passing of the Food Manager Exam to receive credit. Exam date: Monday, 06/11 from Time 8:00 -11:00am in 17-13.**How to Begin Course:** Log into Canvas through the eLearning Tools tab in the Mt. SAC portal at my.mtsac.edu. Then click on the Canvas link and then click on CRN for your DL course. **NOTE:** Some courses may not be activated until the start of the term. If you cannot locate your DL course in Canvas when the term starts, contact the professor.**Professor contact info:** Email Professor STAFF at either: STAFF@mtsac.edu, through Student Detail Schedule or Canvas at MyMtSAC Portal.**Students must use their Mt. SAC e-mail account and be aware of course commitment and student expectations described at <http://www.mtsac.edu/instruction/learning/distlearn/>****■ HRM 54 — Basic Cooking Techniques 3.0 Units**

Professional cooking techniques for commercial operations. Uniform, knife set, ServSafe Manager Certification required.

41231 TTh 7:30am - 9:35am Doonan, S 78-1190
and TTh 9:45am - 12:55pm Doonan, S 78-1190
8 Weeks, Week beginning 02/26/2018 ending 04/22/2018**NOTE: CRN 41231** Students must carry a valid Food Handler Card or Food Manager Card before registering for the class and present their card on the first day of class. Students without a Food Handler Card may be dropped from class.41232 TTh 7:30am - 9:35am Doonan, S 78-1190
and TTh 9:45am - 12:55pm Doonan, S 78-1190
8 Weeks, Week beginning 02/26/2018 ending 04/22/2018**NOTE: CRN 41232 is restricted** to students who have applied and been accepted into the Culinary Arts Cohort.**Effective Mon., 2/5 @ 12:30 PM, this section will be OPENED TO ALL students.****NOTE: Students must carry a valid Food Handler Card or Food Manager Card before registering for the class and present their card on the first day of class. Students without a Food Handler Card may be dropped from class.****■ HRM 81 — Garde Manger 3.0 Units**

Preparation and presentation of: sauces, soups, salads, sandwiches, appetizers, hors d'oeuvres, and buffets.

41234 TTh 1:15pm - 3:20pm Shum, M 78-1190
and TTh 3:30pm - 6:40pm Shum, M 78-1190
8 Weeks, Week beginning 02/26/2018 ending 04/22/2018**NOTE: CRN 43955** Students must carry a valid Food Handler Card or Food Manager Card before registering for the class and present their card on the first day of class. Students without a Food Handler Card may be dropped from class.41235 TTh 1:15pm - 3:20pm Shum, M 78-1190
and TTh 3:30pm - 6:40pm Shum, M 78-1190
8 Weeks, Week beginning 02/26/2018 ending 04/22/2018**NOTE: CRN 41235 is restricted** to students who have applied and been accepted into the Culinary Arts Cohort.**Effective Mon., 2/5 @ 12:30 PM, this section will be OPENED TO ALL students.****NOTE: Students must carry a valid Food Handler Card or Food Manager Card before registering for the class and present their card on the first day of class. Students without a Food Handler Card may be dropped from class.****■ HRM 82 — Baking and Pastry 3.0 Units**

Preparation of baked goods and pastries.

41236 TTh 1:15pm - 3:20pm Shum, M 78-1190
and TTh 3:30pm - 6:40pm Shum, M 78-1190
8 Weeks, Week beginning 04/23/2018 ending 06/17/2018**NOTE: CRN 41236** Students must carry a valid Food Handler Card or Food Manager Card before registering for the class and present their card on the first day of class. Students without a Food Handler Card may be dropped from class.41237 TTh 1:15pm - 3:20pm Shum, M 78-1190
and TTh 3:30pm - 6:40pm Shum, M 78-1190
8 Weeks, Week beginning 04/23/2018 ending 06/17/2018**NOTE: CRN 41237 is restricted** to students who have applied and been accepted into the Culinary Arts Cohort.**Effective Mon., 2/5 @ 12:30 PM, this section will be OPENED TO ALL students. NOTE: Students must carry a valid Food Handler Card or Food Manager Card before registering for the class and present their card on the first day of class. Students without a Food Handler Card may be dropped from class.****■ HRM 83 — International Cuisines 3.0 Units**

Preparation of international cuisines from Asia, Europe, the Mediterranean, and Latin America.

41238 TTh 7:30am - 9:35am Doonan, S 78-1190
and TTh 9:40am - 12:55pm Doonan, S 78-1190
8 Weeks, Week beginning 04/23/2018 ending 06/17/2018**NOTE: CRN 41238** Students must carry a valid Food Handler Card or Food Manager Card before registering for the class and present their card on the first day of class. Students without a Food Handler Card may be dropped from class.41239 TTh 7:30am - 9:35am Doonan, S 78-1190
and TTh 9:45am - 12:55pm Doonan, S 78-1190
8 Weeks, Week beginning 04/23/2018 ending 06/17/2018**NOTE: CRN 41239 is restricted** to students who have applied and been accepted into the Culinary Arts Cohort.**Effective Mon., 2/5 @ 12:30 PM, this section will be OPENED TO ALL students. NOTE: Students must carry a valid Food Handler Card or Food Manager Card before registering for the class and present their card on the first day of class. Students without a Food Handler Card may be dropped from class.****INTERIOR DESIGN****■ ID 10 — Introduction to Interior Design 2.0 Units**

Interior design that meet individual, functional and environmental needs. Field trips may be required.

41166 MW 9:45am - 11:50am Ball, H 77-2070
8 Weeks, Week beginning 02/26/2018 ending 04/22/2018

KINESIOLOGY: ATHLETICS

■ KINX 9 — Conditioning for Sports .5 Unit

Conditioning for athletes to develop muscular strength and endurance, flexibility, core training skills, and cardio fitness.

44216 TThF 5:45am - 7:05am Lepp, J POOL

8 Weeks, Week beginning 02/26/2018 ending 04/22/2018

NOTE: CRN 44216: is conditioning for intercollegiate Women's Swimming and Diving Team members. No-cost digital textbooks or textual materials used.

KINESIOLOGY: FITNESS

■ KINF 10A — Weight Training - Beginning .5 Units

44469 arrange 4.75 hours Jastrab, R 44-1800

8 Weeks, Week beginning 04/23/2018 ending 06/17/2018

NOTE: CRN 44469: Students must come to Building 44 on Monday, Tuesday, or Wednesday of the first week of class for completion of Orientation. Weight Room hours are MTWTh 7:00 a.m. - 9:10 p.m., F 7:00 a.m. - 6:20 p.m. No-cost digital textbooks or textual materials used.

■ KINF 10A — Weight Training - Beginning 1.0 Unit

44277 arrange 6.75 hours Jastrab, R 44-1800

8 Weeks, Week beginning 04/23/2018 ending 06/17/2018

NOTE: CRN 44277: Students must come to Building 44 on Monday, Tuesday, or Wednesday of the first week of class for completion of Orientation. Weight Room hours are MTWTh 7:00 a.m. - 9:10 p.m., F 7:00 a.m. - 6:20 p.m. No-cost digital textbooks or textual materials used.

■ KINF 10B — Weight Training - Intermediate .5 Units

44276 arrange 4.5 hours Jastrab, R 44-1800

8 Weeks, Week beginning 04/23/2018 ending 06/17/2018

NOTE: CRN 44276: Students must come to Building 44 on Monday, Tuesday, or Wednesday of the first week of class for completion of Orientation. Weight Room hours are MTWTh 7:00 a.m. - 9:10 p.m., F 7:00 a.m. - 6:20 p.m. No-cost digital textbooks or textual materials used.

■ KINF 10B — Weight Training - Intermediate 1.0 Unit

44278 arrange 6.75 hours Jastrab, R 44-1800

8 Weeks, Week beginning 04/23/2018 ending 06/17/2018

NOTE: CRN 44278: Students must come to Building 44 on Monday or Tuesday of the FIRST WEEK of class for completion of Orientation. Weight Room hours are MTWTh 7:00 a.m. - 9:10 p.m., F 7:00 a.m. - 6:20 p.m.

No-cost digital textbooks or textual materials used.

■ KINF 36A — Circuit Training Beginning .5 Units

Beginning Circuit Training for individuals with little or no weight training experience.

44281 arrange 4.5 hours Lanaro, G 27A-2

8 Weeks, Week beginning 04/23/2018 ending 06/17/2018

NOTE: CRN 44281: Students must come to Building 27A, ESWC between the hours of 7:00 a.m.-3:00 p.m., 6:00 p.m.-9:00 p.m. On Monday or Tuesday during the FIRST WEEK OF THE TERM to "E" (Enter into class) and schedule your orientations, or your space will be given to a student on the Wait List. Class Open Hours: MTWThF 7:00 a.m.-3:00 p.m., MTWTh 6:00 p.m.-9:00 p.m. No-cost digital textbooks or textual materials used.

■ KINF 36A — Circuit Training Beginning 1.0 Unit

Beginning Circuit Training for individuals with little or no weight training experience.

44283 arrange 6.75 hours STAFF 27A-2

8 Weeks, Week beginning 04/23/2018 ending 06/17/2018

NOTE: CRN 44283: Students must come to Building 27A, ESWC between the hours of 7:00 a.m.-3:00 p.m., 6:00 p.m.-9:00 p.m. On Monday or Tuesday during the FIRST WEEK OF THE TERM to "E" (Enter into class) and schedule your orientations, or your space will be given to a student on the Wait List. Class Open Hours: MTWThF 7:00 a.m.-3:00 p.m., MTWTh 6:00 p.m.-9:00 p.m. No-cost digital textbooks or textual materials used.

■ KINF 36B — Circuit Training Intermediate .5 Units

Circuit training for students with previous strength training experience.

44282 arrange 4.5 hours Lanaro, G 27A-2

8 Weeks, Week beginning 04/23/2018 ending 06/17/2018

NOTE: CRN 44282: Students must come to Building 27A, ESWC between the hours of 7:00 a.m.-3:00 p.m., 6:00 p.m.-9:00 p.m. On Monday or Tuesday during the FIRST WEEK OF THE TERM to "E" (Enter into class) and schedule your orientations, or your space will be given to a student on the Wait List. Class Open Hours: MTWThF 7:00 a.m.-3:00 p.m., MTWTh 6:00 p.m.-9:00 p.m. No-cost digital textbooks or textual materials used.

■ KINF 36B — Circuit Training Intermediate 1.0 Unit

Circuit training for students with previous strength training experience.

44284 arrange 6.75 hours Lanaro, G 27A-2

8 Weeks, Week beginning 04/23/2018 ending 06/17/2018

NOTE: CRN 44284: Students must come to Building 27A, ESWC between the hours of 7:00 a.m.-3:00 p.m., 6:00 p.m.-9:00 p.m. On Monday or Tuesday during the FIRST WEEK OF THE TERM to "E" (Enter into class) and schedule your orientations, or your space will be given to a student on the Wait List. Class Open Hours: MTWThF 7:00 a.m.-3:00 p.m., MTWTh 6:00 p.m.-9:00 p.m. No-cost digital textbooks or textual materials used.

■ KINF 53 — Physical Training for the Basic Fire Academy 2.5 Units

44161 MTWThF 5:00am - 7:05am Morris, J LOT50G

13 Weeks, Week beginning 02/26/2018 ending 05/27/2018

NOTE: CRN 44161: No-cost digital textbooks or textual materials used.

KINESIOLOGY: THEORY

■ KIN 34 — Fitness for Living 3.0 Units

Survey and analysis of the components of fitness. Effects of fitness, stress management, nutrition and weight control on health.

44228 MW 3:00pm - 6:10pm Hackmann, D TBA

8 Weeks, Week beginning 04/23/2018 ending 06/17/2018

44286 arrange 6.75 hours Knott-Silva, T ONLINE

8 Weeks, Week beginning 02/26/2018 ending 04/22/2018

NOTE: CRN 44286 is a Distance Learning Online Class.

How to Begin Course: Log into Canvas through <http://myportal.mtsac.edu> and click on CRN for your DL course. **NOTE:** Some courses may not be activated until the start of the term. If you cannot locate your DL course in Canvas when the term starts, contact the professor.

Professor contact info: Email Professor Bowen at either: mbowen@mtsac.edu, through Student Detail Schedule or Canvas at MyMtSAC Portal.

Students must use their Mt. SAC e-mail account and be aware of course commitment and student expectations described at <http://www.mtsac.edu/instruction/learning/distlearn/>

To prepare for a successful online learning experience, see helpful short videos at <http://www.mtsac.edu/distancelearning/quiz/>

44287 arrange 6.75 hours Bowen, M ONLINE

8 Weeks, Week beginning 04/23/2018 ending 06/17/2018

NOTE: CRN 44287 is a Distance Learning Online Class.

How to Begin Course: Log into Canvas through <http://myportal.mtsac.edu> and click on CRN for your DL course. **NOTE:** Some courses may not be activated until the start of the term. If you cannot locate your DL course in Canvas when the term starts, contact the professor.

Professor contact info: Email Professor Bowen at either: mbowen@mtsac.edu, through Student Detail Schedule or Canvas at MyMtSAC Portal.

Students must use their Mt. SAC e-mail account and be aware of course commitment and student expectations described at <http://www.mtsac.edu/instruction/learning/distlearn/>

To prepare for a successful online learning experience, see helpful short videos at <http://www.mtsac.edu/distancelearning/quiz/>

LEARNING ASSISTANCE

■ LERN 48 — Basic Math Skills Review 3.0 Units

Math fundamentals: whole number and decimal operations with an emphasis on math learning strategies.

43592 MW 8:00am - 11:10am Damansouz, F 6-112
8 Weeks, Week beginning 02/26/2018 ending 04/22/2018

■ LERN 49 — Math Skills Review 3.0 Units

Improves knowledge of basic math. Includes operations and applied problems. Covers math study strategies.

43603 MW 8:00am - 11:10am Damansouz, F 6-112
8 Weeks, Week beginning 04/23/2018 ending 06/17/2018

43611 TTh 8:00am - 11:10am Hall, M 6-112
8 Weeks, Week beginning 02/26/2018 ending 04/22/2018

NOTE: CRN 43611 above is designed for students in the Bridge Program. Attendance at an information session and special approval are needed to enroll in this learning community. This course is linked to MATH 50 (CRN 42019) and LCOM 90 (CRN 43673). For more information, please contact (909)274-5392.

43616 TTh 8:00am - 11:10am Hall, M 6-222
8 Weeks, Week beginning 04/23/2018 ending 06/17/2018

LIBRARY AND INSTRUCTIONAL MEDIA

■ LIBR 1A — Introduction to Library Research 1.0 Unit

Introduction to academic research, finding, evaluating, and citing sources. Recommended for students who have not taken LIBR 1.

43683 T 12:00pm - 2:05pm Rios-Alvarado, E 6-238
8 Weeks, Week beginning 04/23/2018 ending 06/17/2018

NOTE: No cost digital textbooks or textual materials used.

43670 arrange 2.25 hours Swartz, P ONLINE
8 Weeks, Week beginning 04/23/2018 ending 06/17/2018

NOTE: No cost digital textbooks or textual materials used.

NOTE: CRN 43670 is a Distance Learning Online Class.

How to Begin Course: Log into Canvas through the e-Learning Tools tab in the Mt.SAC portal at inside.mtsac.edu. Then click on the Canvas link and then click on CRN for your DL course. **NOTE:** Some courses may not be activated until the start of the term. If you cannot locate your DL course in Canvas when the term starts, contact the professor. **On the first day of classes, log into your DL course to show your "attendance" because not doing so could result in your being dropped from the class for non-attendance.**

Professor contact info: Email Professor Swartz at either: Pswartz@mtsac.edu, through Student Detail Schedule or Canvas at MyMtSAC Portal.

Students must use their Mt.SAC e-mail account and be aware of course commitment and student expectations described at <http://www.mtsac.edu/distancelearning/>

To prepare for a successful online learning experience, see helpful short videos at <http://www.mtsac.edu/distancelearning/quiz/>

MATHEMATICS

■ MATH 50 — Pre-Algebra 3.0 Units

Fundamental principles of mathematics designed to ease the transition from arithmetic to algebra.

42017 MTWTh 8:00am - 9:25am Wakefield, J 61-3306
8 Weeks, Week beginning 02/26/2018 ending 04/22/2018

42018 MTWTh 8:00am - 9:25am Wakefield, J 61-3306
8 Weeks, Week beginning 04/23/2018 ending 06/17/2018

42026 T 8:00am - 11:10am Chavez, D 61-2414
and arrange 3.4 hours Chavez, D ONLINE
8 Weeks, Week beginning 02/26/2018 ending 04/22/2018

NOTE: CRN 42026 is an 8-week Hybrid Class taught partially online with Schedule Meetings on Campus.

How to Begin Course: Log into Moodlerooms through the eLearning Tools tab in the Mt. SAC portal at my.mtsac.edu. Click on the Moodlerooms link and then click on the CRN for your DL course. **NOTE:** Some courses may not be activated until the start of the term. If you cannot locate your DL course in Moodlerooms when the term starts, contact the professor.

Professor contact info: Email Professor Chavez at either: dchavez@mtsac.edu, through Student Detail Schedule or Moodlerooms at MyMtSAC Portal.

Students must use their Mt. SAC e-mail account and be aware of course commitments and student expectations described at <http://www.mtsac.edu/instruction/learning/distlearn/>

42019 TTh 8:00am - 11:10am Ma, J 6-112
8 Weeks, Week beginning 04/23/2018 ending 06/17/2018

NOTE: CRN 42019 above is designed for students in the Bridge Program. Attendance at an information session and special approval are needed to enroll in this learning community. This course is linked to LERN 49 (CRN 43611) and LCOM 90 (CRN 43673). For more information, please contact (909)274-5392.

42027 Th 8:00am - 11:10am Chavez, D 61-2414
and arrange 3.4 hours Chavez, D ONLINE
8 Weeks, Week beginning 02/26/2018 ending 04/22/2018

NOTE: CRN 42027 is an 8-week Hybrid Class taught partially online with Schedule Meetings on Campus.

How to Begin Course: Log into Moodlerooms through the eLearning Tools tab in the Mt. SAC portal at my.mtsac.edu. Click on the Moodlerooms link and then click on the CRN for your DL course. **NOTE:** Some courses may not be activated until the start of the term. If you cannot locate your DL course in Moodlerooms when the term starts, contact the professor.

Professor contact info: Email Professor Chavez at either: dchavez@mtsac.edu, through Student Detail Schedule or Moodlerooms at MyMtSAC Portal.

Students must use their Mt. SAC e-mail account and be aware of course commitments and student expectations described at <http://www.mtsac.edu/instruction/learning/distlearn/>

42032 TWTh 12:00pm - 2:05pm Peng, G 61-3310
8 Weeks, Week beginning 02/26/2018 ending 04/22/2018

NOTE: CRN 42032 above is designed for students in the Bridge Program. Attendance at an information session and special approval are needed to enroll in this learning community. This course is linked to MATH 51 (CRN 42052) and COUN 2 (CRN 44291). For more information, please contact (909)274-5392.

42261 TWTh 7:00pm - 9:05pm Hernandez-Saul, C 61-3306
8 Weeks, Week beginning 02/26/2018 ending 04/22/2018

NOTE: CRN 42261 is linked to CRN 42251 and is a part of the Pathways Program. This course is continuing from the Winter term and seats are reserved for students already in the program. Any additional seats will be open for registration to any eligible student. This course is a part of Math Cohort #10. If you have any questions please email pathways@mtsac.edu or call (909) 274-5703.

■ MATH 51 — Elementary Algebra **4.0 Units**

An introductory course in algebra.

42046 MTWTh 9:45am - 11:50am Wakefield, J 61-3306

8 Weeks, Week beginning 02/26/2018 ending 04/22/2018

NOTE: CRN 42046 is linked to CRN 42076 and is a part of the Pathways Program. This course is continuing from the Winter term and seats are reserved for students already in the program. Any additional seats will be open for registration to any eligible student. This course is a part of Math Cohort #9. If you have any questions please email pathways@mtsac.edu or call (909) 274-5703.

42047 MTWTh 9:45am - 11:50am Munro, M 61-2306

8 Weeks, Week beginning 02/26/2018 ending 04/22/2018

NOTE: CRN 42047 above is designed for students in the Bridge Program. Attendance at an information session and special approval are needed to enroll in this learning community. This course is linked to MATH 71 (CRN 42075) and COUN 5 (CRN 44411). For more information, please contact (909)274-5392.

42052 MTWTh 12:00pm - 2:05pm Peng, G 61-3310

8 Weeks, Week beginning 04/23/2018 ending 06/17/2018

NOTE: CRN 42052 above is designed for students in the Bridge Program. Attendance at an information session and special approval are needed to enroll in this learning community. This course is linked to MATH 50 (CRN 42032) and COUN 2 (CRN 44291). For more information, please contact (909)274-5392.

42053 MTWTh 12:00pm - 2:05pm Case, M 61-2414

8 Weeks, Week beginning 02/26/2018 ending 04/22/2018

NOTE: CRN 42053 is linked to CRN 42088 and is a part of the Pathways Program. This course is continuing from the Winter term and seats are reserved for students already in the program. Any additional seats will be open for registration to any eligible student. This course is a part of Math Cohort #8. If you have any questions please email pathways@mtsac.edu or call (909) 274-5703.

42251 TWTh 7:00pm - 9:50pm Hernandez-Saul, C 61-3306

8 Weeks, Week beginning 04/23/2018 ending 06/17/2018

NOTE: CRN 42251 is linked to CRN 42261 and is a part of the Pathways Program. This course is continuing from the Winter term and seats are reserved for students already in the program. Any additional seats will be open for registration to any eligible student. This course is a part of Math Cohort #10. If you have any questions please email pathways@mtsac.edu or call (909) 274-5703.

■ MATH 71 — Intermediate Algebra **5.0 Units**

Extends concepts from elementary algebra to prepare students for college-level mathematics courses.

42069 MTWTh 7:00am - 9:35am Kirchgraber, A 61-2302

8 Weeks, Week beginning 02/26/2018 ending 04/22/2018

NOTE: CRN 42069 is linked to CRN 42112 and is a part of the Pathways Program. This course is continuing from the Winter term and seats are reserved for students already in the program. Any additional seats will be open for registration to any eligible student. This course is a part of Math Cohort #11. If you have any questions please email pathways@mtsac.edu or call (909) 274-5703.

42075 MTWTh 9:45am - 12:20pm Munro, M 61-2306

8 Weeks, Week beginning 04/23/2018 ending 06/17/2018

NOTE: CRN 42075 above is designed for students in the Bridge Program. Attendance at an information session and special approval are needed to enroll in this learning community. This course is linked to MATH 51 (CRN 42047) and COUN 5 (CRN 44411). For more information, please contact (909)274-5392.

42076 MTWTh 9:45am - 12:20pm Wakefield, J 61-3306

8 Weeks, Week beginning 04/23/2018 ending 06/17/2018

NOTE: CRN 42076 is linked to CRN 42046 and is a part of the Pathways Program. This course is continuing from the Winter term and seats are reserved for students already in the program. Any additional seats will be open for registration to any eligible student. This course is a part of Math Cohort #9. If you have any questions please email pathways@mtsac.edu or call (909) 274-5703.

42079 TWThF 9:45am - 12:20pm Takashima, T 61-2310

8 Weeks, Week beginning 02/26/2018 ending 04/22/2018

42080 TWThF 9:45am - 12:20pm Takashima, T 61-2310

8 Weeks, Week beginning 04/23/2018 ending 06/17/2018

42088 MTWTh 12:30pm - 3:05pm Case, M 61-2414

8 Weeks, Week beginning 04/23/2018 ending 06/17/2018

NOTE: CRN 42088 is linked to CRN 42053 and is a part of the Pathways Program. This course is continuing from the Winter term and seats are reserved for students already in the program. Any additional seats will be open for registration to any eligible student. This course is a part of Math Cohort #8. If you have any questions please email pathways@mtsac.edu or call (909) 274-5703.

■ MATH 96 — Strategies for Math Success **1.0 Unit**

Perspectives and strategies to utilize a learning system to acquire, understand, and remember mathematical knowledge.

42220 TTh 7:00pm - 8:50pm Long, G 61-2414

5 Weeks, Week beginning 02/26/2018 ending 04/01/2018

42283 TTh 7:00pm - 8:50pm Long, G 61-2414

5 Weeks, Week beginning 04/02/2018 ending 05/06/2018

42284 TTh 7:00pm - 8:50pm Long, G 61-2414

5 Weeks, Week beginning 05/07/2018 ending 06/10/2018**■ MATH 110 — Elementary Statistics** **3.0 Units**

Descriptive and inferential statistics and probability with emphasis on statistical methods.

42112 MTWTh 8:00am - 9:25am Kirchgraber, A 61-2302

8 Weeks, Week beginning 04/23/2018 ending 06/17/2018

NOTE: CRN 42112 is linked to CRN 42069 and is a part of the Pathways Program. This course is continuing from the Winter term and seats are reserved for students already in the program. Any additional seats will be open for registration to any eligible student. This course is a part of Math Cohort #11. If you have any questions please email pathways@mtsac.edu or call (909) 274-5703.

MENTAL HEALTH/PSYCHIATRIC TECHNICIAN

■ **MENT 82 — Work Experience in Mental Health Technology 2.0 Units**
On-the-job experience at an approved work site. Requires 150 paid or 120 non-paid hours.

44445 arrange 25 hours James-Perez, S 18C
6 Weeks, Week beginning 02/26/2018 ending 04/09/2018

NOTE: MENT 82 Work Experience, CRN 44445 is only for eligible students who are in the Alcohol Drug Program.

44446 arrange 25 hours James-Perez, S 18C
6 Weeks, Week beginning 04/10/2018 ending 05/21/2018

NOTE: MENT 82 Work Experience, CRN 44446 is only for eligible students who are in the Alcohol Drug Program.

MUSIC

■ **MUS 15 — Rock Music History and Appreciation 3.0 Units**
Historical survey of rock music from its beginnings in the early 1950s to the present.

43841 S 8:00am - 2:30pm Jones, J 2-M107
8 Weeks, Week beginning 02/26/2018 ending 04/22/2018

NURSING

■ **NURS 1A — The Nursing Process I 5.0 Units**

41272 M 7:00am - 10:50am Berch, K 67A-150
and M 1:00pm - 2:35pm Berch, K 67A-150
and arrange 16.88 hours Berch, K BROOK
8 Weeks, Week beginning 02/26/2018 ending 04/22/2018

41273 M 7:00am - 10:50am Berch, K 67A-150
and M 1:00pm - 2:35pm Berch, K 67A-150
and arrange 16.88 hours Andrada-Mamisay, D PKVSTA
8 Weeks, Week beginning 02/26/2018 ending 04/22/2018

41274 M 7:00am - 10:50am Berch, K 67A-150
and M 1:00pm - 2:35pm Berch, K 67A-150
and arrange 16.88 hours Boyer, M SILVER
8 Weeks, Week beginning 02/26/2018 ending 04/22/2018

41275 M 7:00am - 10:50am Berch, K 67A-150
and M 1:00pm - 2:35pm Berch, K 67A-150
and arrange 16.88 hours Hernandez, A HILL
8 Weeks, Week beginning 02/26/2018 ending 04/22/2018

41276 M 7:00am - 10:50am Berch, K 67A-150
and M 1:00pm - 2:35pm Berch, K 67A-150
and arrange 16.88 hours Anderson-Perry, C SILVAL
8 Weeks, Week beginning 02/26/2018 ending 04/22/2018

41277 M 7:00am - 10:50am Berch, K 67A-150
and M 1:00pm - 2:35pm Berch, K 67A-150
and arrange 16.88 hours Boyer, M SILVER
8 Weeks, Week beginning 02/26/2018 ending 04/22/2018

■ **NURS 1B — The Nursing Process II 5.0 Units**

41278 M 7:00am - 10:50am Boyer, M 67A-150
and M 1:00pm - 2:35pm Boyer, M 67A-150
and arrange 16.88 hours Boyer, M CHINO
8 Weeks, Week beginning 04/23/2018 ending 06/17/2018

41279 M 7:00am - 10:50am Boyer, M 67A-150
and M 1:00pm - 2:35pm Boyer, M 67A-150
and arrange 16.88 hours Orr, J CHINO
8 Weeks, Week beginning 04/23/2018 ending 06/17/2018

41280 M 7:00am - 10:50am Boyer, M 67A-150
and M 1:00pm - 2:35pm Boyer, M 67A-150
and arrange 16.88 hours Berch, K SARH
8 Weeks, Week beginning 04/23/2018 ending 06/17/2018

41281 M 7:00am - 10:50am Boyer, M 67A-150
and M 1:00pm - 2:35pm Boyer, M 67A-150
and arrange 16.88 hours Harrington, M CCHCH
8 Weeks, Week beginning 04/23/2018 ending 06/17/2018

41282 M 7:00am - 10:50am Boyer, M 67A-150
and M 1:00pm - 2:35pm Boyer, M 67A-150
and arrange 16.88 hours STAFF PVHMC
8 Weeks, Week beginning 04/23/2018 ending 06/17/2018

41283 M 7:00am - 10:50am Boyer, M 67A-150
and M 1:00pm - 2:35pm Boyer, M 67A-150
and arrange 16.88 hours STAFF PIH
8 Weeks, Week beginning 04/23/2018 ending 06/17/2018

■ **NURS 2 — Pharmacology 2.0 Units**

41284 Th 7:30am - 10:20am Romero, O 67A-150
12 Weeks, Week beginning 02/26/2018 ending 05/20/2018

41574 Th 7:30am - 10:20am Romero, O 67A-150
12 Weeks, Week beginning 02/26/2018 ending 05/20/2018

■ **NURS 3 — Medical-Surgical Nursing: Locomotion/Sensory/Integ/Oncologu 3.5 Units**

41285 M 7:00am - 10:50am Orr, J 67A-206
and M 1:00pm - 2:30pm Orr, J 67A-206
and arrange 18 hours Orr, J CHINO
6 Weeks, Week beginning 02/26/2018 ending 04/08/2018

41286 M 7:00am - 10:50am Orr, J 67A-206
and M 1:00pm - 2:30pm Orr, J 67A-206
and arrange 18 hours Nln, T FOOT
6 Weeks, Week beginning 02/26/2018 ending 04/08/2018

41287 M 7:00am - 10:50am Orr, J 67A-206
and M 1:00pm - 2:30pm Orr, J 67A-206
and arrange 18 hours Coleman, D PVHMC
6 Weeks, Week beginning 02/26/2018 ending 04/08/2018

41288 M 7:00am - 10:50am Orr, J 67A-206
and M 1:00pm - 2:30pm Orr, J 67A-206
and arrange 18 hours Hauw, W SARH
6 Weeks, Week beginning 02/26/2018 ending 04/08/2018

41289 M 7:00am - 10:50am Orr, J 67A-206
and M 1:00pm - 2:30pm Orr, J 67A-206
and arrange 18 hours Mccarty, A PIH
6 Weeks, Week beginning 02/26/2018 ending 04/08/2018

41290 M 7:00am - 10:50am Orr, J 67A-206
and M 1:00pm - 2:30pm Orr, J 67A-206
and arrange 18 hours Reyes, A ICC
5 Weeks, Week beginning 02/26/2018 ending 04/08/2018

■ NURS 4 — Maternity Nursing				3.0 Units
41291	M	7:00am - 9:50am	Condra, D	67A-206
and	M	1:00pm - 3:30pm	Smith, K	67A-206
		and arrange 16.2 hours	STAFF	PVHMC
5 Weeks, Week beginning 04/09/2018 ending 05/13/2018				
41292	M	7:00am - 9:50am	Condra, D	67A-206
and	M	1:00pm - 3:30pm	STAFF	67A-206
		and arrange 16.2 hours	STAFF	QOVH
5 Weeks, Week beginning 04/09/2018 ending 05/13/2018				
41293	M	7:00am - 9:50am	Condra, D	67A-206
and	M	1:00pm - 3:30pm	Cannon, S	67A-206
		and arrange 16.2 hours	STAFF	SARH
5 Weeks, Week beginning 04/09/2018 ending 05/13/2018				
41294	M	7:00am - 9:50am	Condra, D	67A-206
and	M	1:00pm - 3:30pm	STAFF	67A-206
		and arrange 16.2 hours	STAFF	PVHMC
5 Weeks, Week beginning 04/09/2018 ending 05/13/2018				
41295	M	7:00am - 9:50am	Condra, D	67A-206
and	M	1:00pm - 3:30pm	Carter, D	67A-206
		and arrange 16.2 hours	STAFF	WHIT
5 Weeks, Week beginning 04/09/2018 ending 05/13/2018				
41296	M	7:00am - 9:50am	Condra, D	67A-206
and	M	1:00pm - 3:30pm	Cailipan, A	67A-206
		and arrange 16.2 hours	STAFF	QOVH
5 Weeks, Week beginning 04/09/2018 ending 05/13/2018				

■ NURS 5 — Psychiatric Nursing				3.0 Units
41297	M	7:00am - 9:50am	Anderson-Perry, C	67A-205
and	M	1:00pm - 3:30pm	Anderson-Perry, C	67A-205
		and arrange 16.2 hours	Anderson-Perry, C	BHC
5 Weeks, Week beginning 05/14/2018 ending 06/17/2018				
41298	M	7:00am - 9:50am	Anderson-Perry, C	67A-205
and	M	1:00pm - 3:30pm	Elmgren, M	67A-205
		and arrange 16.2 hours	Fuentes, W	CHART
5 Weeks, Week beginning 05/14/2018 ending 06/17/2018				
41299	M	7:00am - 9:50am	Anderson-Perry, C	67A-205
and	M	1:00pm - 3:30pm	Macaraeg, A	67A-205
		and arrange 16.2 hours	STAFF	CHC
5 Weeks, Week beginning 05/14/2018 ending 06/17/2018				
41300	M	7:00am - 9:50am	Anderson-Perry, C	67A-205
and	M	1:00pm - 3:30pm	Mahood, K	67A-205
		and arrange 16.2 hours	STAFF	CHART
5 Weeks, Week beginning 05/14/2018 ending 06/17/2018				
41301	M	7:00am - 9:50am	Anderson-Perry, C	67A-205
and	M	1:00pm - 3:30pm	Kassis, N	67A-205
		and arrange 16.2 hours	STAFF	CHART
5 Weeks, Week beginning 05/14/2018 ending 06/17/2018				
41302	M	7:00am - 9:50am	Anderson-Perry, C	67A-205
and	M	1:00pm - 3:30pm	STAFF	67A-205
		and arrange 16.2 hours	STAFF	HOSP
5 Weeks, Week beginning 05/14/2018 ending 06/17/2018				

■ NURS 6 — Pediatric Nursing				3.0 Units
41303	M	7:00am - 9:50am	Berch, K	67A-206
and	M	1:00pm - 3:30pm	Kunkler, C	67A-206
		and arrange 16.2 hours	Hinson, J	PVHMC
5 Weeks, Week beginning 05/14/2018 ending 06/17/2018				
41304	M	7:00am - 9:50am	Berch, K	67A-206
and	M	1:00pm - 3:30pm	Kunkler, C	67A-206
		and arrange 16.2 hours	Ford-Charles, C	WHIT
5 Weeks, Week beginning 05/14/2018 ending 06/17/2018				
41305	M	7:00am - 9:50am	Berch, K	67A-206
and	M	1:00pm - 3:30pm	Kunkler, C	67A-206
		and arrange 16.2 hours	Vy, V	HUNT
5 Weeks, Week beginning 05/14/2018 ending 06/17/2018				
41306	M	7:00am - 9:50am	Berch, K	67A-206
and	M	1:00pm - 3:30pm	Kunkler, C	67A-206
		and arrange 16.2 hours	Abate, A	PVHMC
5 Weeks, Week beginning 05/14/2018 ending 06/17/2018				
41307	M	7:00am - 9:50am	Berch, K	67A-206
and	M	1:00pm - 3:30pm	Kunkler, C	67A-206
		and arrange 16.2 hours	Radnoti, S	CHLA
5 Weeks, Week beginning 05/14/2018 ending 06/17/2018				
41308	M	7:00am - 9:50am	Berch, K	67A-206
and	M	1:00pm - 3:30pm	Kunkler, C	67A-206
		and arrange 16.2 hours	Nava, M	QOVH
5 Weeks, Week beginning 05/14/2018 ending 06/17/2018				

■ NURS 7 — Medical-Surgical Nursing: Nutrition/Elimination/Surgical Asepsis				7.0 Units
41309	M	7:00am - 10:50am	Ontiveros, J	67A-205
and	M	1:00pm - 3:15pm	Perez, L	67A-205
		and arrange 17.18 hours	STAFF	SARH
11 Weeks, Week beginning 02/26/2018 ending 05/13/2018				
41310	M	7:00am - 10:50am	Ontiveros, J	67A-205
and	M	1:00pm - 3:15pm	Perez, L	67A-205
		and arrange 17.18 hours	Dunaway, J	HOSP
11 Weeks, Week beginning 02/26/2018 ending 05/13/2018				
41311	M	7:00am - 10:50am	Ontiveros, J	67A-205
and	M	1:00pm - 3:15pm	Perez, L	67A-205
		and arrange 17.18 hours	Marquez, A	PVHMC
11 Weeks, Week beginning 02/26/2018 ending 05/13/2018				
41312	M	7:00am - 10:50am	Ontiveros, J	67A-205
and	M	1:00pm - 3:15pm	Perez, L	67A-205
		and arrange 17.18 hours	Ontiveros, J	HOSP
11 Weeks, Week beginning 02/26/2018 ending 05/13/2018				
41313	M	7:00am - 10:50am	Ontiveros, J	67A-205
and	M	1:00pm - 3:15pm	Perez, L	67A-205
		and arrange 17.18 hours	Ha Nguyen, A	QOVH
11 Weeks, Week beginning 02/26/2018 ending 05/13/2018				
41542	M	7:00am - 10:50am	Ontiveros, J	67A-205
and	M	1:00pm - 3:15pm	Perez, L	67A-205
		and arrange 17.18 hours	Riggs, A	ICC
11 Weeks, Week beginning 02/26/2018 ending 05/13/2018				

■ NURS 8 — Medical-Surgical Nursing: Circulation and Oxygenation **5.0 Units**

41314	M	7:00am - 9:50am	Hooper, J	67A-216
and	Th	7:00am - 10:15am	Hooper, J	67A-216
		and arrange 19.29 hours	Hooper, J	SARH
7 Weeks, Week beginning 02/26/2018 ending 04/15/2018				
41315	M	7:00am - 9:50am	Hooper, J	67A-216
and	Th	7:00am - 10:15am	Hooper, J	67A-216
		and arrange 19.29 hours	Chen, G	QOVH
7 Weeks, Week beginning 02/26/2018 ending 04/15/2018				
41316	M	7:00am - 9:50am	Hooper, J	67A-216
and	Th	7:00am - 10:15am	Hooper, J	67A-216
		and arrange 19.29 hours	Perez, L	PIH
7 Weeks, Week beginning 02/26/2018 ending 04/15/2018				
41317	M	7:00am - 9:50am	Hooper, J	67A-216
and	Th	7:00am - 10:15am	Hooper, J	67A-216
		and arrange 19.29 hours	Rutherford, E	ICC
7 Weeks, Week beginning 02/26/2018 ending 04/15/2018				
41318	M	7:00am - 9:50am	Hooper, J	67A-216
and	Th	7:00am - 10:15am	Hooper, J	67A-216
		and arrange 19.29 hours	Romero, O	ICC
7 Weeks, Week beginning 02/26/2018 ending 04/15/2018				
41319	M	7:00am - 9:50am	Hooper, J	67A-216
and	Th	7:00am - 10:15am	Hooper, J	67A-216
		and arrange 19.29 hours	Lynes, B	PVHMC
7 Weeks, Week beginning 02/26/2018 ending 04/15/2018				

■ NURS 9 — Leadership in Nursing **1.0 Unit**

41320	M	1:00pm - 3:50pm	Chen, G	67A-216
6 Weeks, Week beginning 02/26/2018 ending 04/02/2018				

■ NURS 10 — Medical-Surgical Nursing: Integration/Regulation **4.0 Units**

41321	M	8:00am - 10:50am	Perez, L	67A-216
and	M	1:00pm - 2:50pm	Perez, L	67A-216
and	Th	8:30am - 11:00am	Perez, L	67A-216
		and arrange 13.5 hours	Romero, O	ICC
6 Weeks, Week beginning 04/16/2018 ending 05/27/2018				
41322	M	8:00am - 10:50am	Perez, L	67A-216
and	M	1:00pm - 2:50pm	Perez, L	67A-216
and	Th	8:30am - 11:00am	Perez, L	67A-216
		and arrange 13.5 hours	Chen, G	QOVH
6 Weeks, Week beginning 04/16/2018 ending 05/27/2018				
41323	M	8:00am - 10:50am	Perez, L	67A-216
and	M	1:00pm - 2:50pm	Perez, L	67A-216
and	Th	8:30am - 11:00am	Perez, L	67A-216
		and arrange 13.5 hours	Hooper, J	SARH
6 Weeks, Week beginning 04/16/2018 ending 05/27/2018				
41324	M	8:00am - 10:50am	Perez, L	67A-216
and	M	1:00pm - 2:50pm	Perez, L	67A-216
and	Th	8:30am - 11:00am	Perez, L	67A-216
		and arrange 13.5 hours	Rutherford, E	PIH
6 Weeks, Week beginning 04/16/2018 ending 05/27/2018				
41325	M	8:00am - 10:50am	Perez, L	67A-216
and	M	1:00pm - 2:50pm	Perez, L	67A-216
and	Th	8:30am - 11:00am	Perez, L	67A-216
		and arrange 13.5 hours	Lynes, B	PVHMC
6 Weeks, Week beginning 04/16/2018 ending 05/27/2018				
41326	M	8:00am - 10:50am	Perez, L	67A-216
and	M	1:00pm - 2:50pm	Perez, L	67A-216
and	Th	8:30am - 11:00am	Perez, L	67A-216
		and arrange 13.5 hours	STAFF	ICC
6 Weeks, Week beginning 04/16/2018 ending 05/27/2018				

■ NURS 11 — Preceptorship in Nursing **2.0 Units**

41510	arrange	36 hours	Chen, G	HOSP
3 Weeks, Week beginning 05/28/2018 ending 06/17/2018				
41511	arrange	36 hours	Hooper, J	HOSP
3 Weeks, Week beginning 05/28/2018 ending 06/17/2018				
41512	arrange	36 hours	STAFF	HOSP
3 Weeks, Week beginning 05/28/2018 ending 06/17/2018				
41513	arrange	36 hours	STAFF	HOSP
3 Weeks, Week beginning 05/28/2018 ending 06/17/2018				
41514	arrange	36 hours	STAFF	HOSP
3 Weeks, Week beginning 05/28/2018 ending 06/17/2018				
41518	arrange	36 hours	STAFF	PVHMC
3 Weeks, Week beginning 05/28/2018 ending 06/17/2018				

NUTRITION AND FOOD
■ NF 81 — Cooking for Your Heart and Health **1.0 Unit**

Principles and techniques of healthful food preparation. Off-campus meetings may be required.

44381	F	9:45am - 11:05am	Metter, J	78-1140
and	F	11:15am - 1:35pm	Metter, J	78-1140
8 Weeks, Week beginning 04/23/2018 ending 06/17/2018				

■ NF 82 — Vegetarian Cuisine **1.0 Unit**

Principles and techniques of vegetarian food preparation. Off-campus meetings may be required.

44217	F	9:45am - 11:15am	Metter, J	78-1140
and	F	11:25am - 2:00pm	Metter, J	78-1140
8 Weeks, Week beginning 02/26/2018 ending 04/22/2018				

PHILOSOPHY
■ PHIL 3 — Introduction to Logic **3.0 Units**

Analysis of language as an instrument of sound thinking in morals, politics and everyday life.

42460	arrange	6.75 hours	Mc Gruder, C	ONLINE
8 Weeks, Week beginning 02/26/2018 ending 04/22/2018				

NOTE: CRN 42460 is a Distance Learning Online Class.

How to Begin Course: Log into Canvas through <http://myportal.mtsac.edu> and click on CRN for your DL course. **NOTE:** Some courses may not be activated until the start of the term. If you cannot locate your DL course in Canvas when the term starts, contact the professor. **On the first day of classes, log into your DL course to show your "attendance" because not doing so could result in your being dropped from the class for non-attendance.**

Professor contact info: Please visit the course website at <http://instruction.mtsac.edu/cmcruder> or you can email Professor Mc Gruder at either: CMcGruder@mtsac.edu, through Student Detail Schedule or Canvas at MyMtSAC Portal.

Students must use their Mt. SAC e-mail account and be aware of course commitment and student expectations described at <http://www.mtsac.edu/instruction/learning/distlearn/>

To prepare for a successful online learning experience, see helpful short videos at <http://www.mtsac.edu/distancelearning/quiz/>

42461 arrange 6.75 hours Mc Gruder, C ONLINE

8 Weeks, Week beginning 02/26/2018 ending 04/22/2018**NOTE:** CRN 42461 is a Distance Learning Online Class.

How to Begin Course: Log into Canvas through <http://myportal.mtsac.edu> and click on CRN for your DL course. **NOTE:** Some courses may not be activated until the start of the term. If you cannot locate your DL course in Canvas when the term starts, contact the professor. **On the first day of classes, log into your DL course to show your "attendance" because not doing so could result in your being dropped from the class for non-attendance.**

Professor contact info: Please visit the course website at <http://instruction.mtsac.edu/cmcruder> or you can email Professor Mc Gruder at either: CMcGruder@mtsac.edu, through Student Detail Schedule or Canvas at MyMtSAC Portal.

Students must use their Mt. SAC e-mail account and be aware of course commitment and student expectations described at <http://www.mtsac.edu/instruction/learning/distlearn/>

To prepare for a successful online learning experience, see helpful short videos at <http://www.mtsac.edu/distancelearning/quiz/>

42615 arrange 6.75 hours Mc Gruder, C ONLINE

8 Weeks, Week beginning 02/26/2018 ending 04/22/2018**NOTE:** CRN 42615 is a Distance Learning Online Class.

How to Begin Course: Log into Canvas through <http://myportal.mtsac.edu> and click on CRN for your DL course. **NOTE:** Some courses may not be activated until the start of the term. If you cannot locate your DL course in Canvas when the term starts, contact the professor. **On the first day of classes, log into your DL course to show your "attendance" because not doing so could result in your being dropped from the class for non-attendance.**

Professor contact info: Please visit the course website at <http://instruction.mtsac.edu/cmcruder> or you can email Professor Mc Gruder at either: CMcGruder@mtsac.edu, through Student Detail Schedule or Canvas at MyMtSAC Portal.

Students must use their Mt. SAC e-mail account and be aware of course commitment and student expectations described at <http://www.mtsac.edu/instruction/learning/distlearn/>

To prepare for a successful online learning experience, see helpful short videos at <http://www.mtsac.edu/distancelearning/quiz/>

■ **PHIL 5 — Introduction to Philosophy** **3.0 Units**

Philosophical ideas concerning knowledge, reality, and values.

42462 arrange 6.75 hours Lane, D ONLINE

8 Weeks, Week beginning 02/26/2018 ending 04/22/2018**NOTE:** CRN 42462 is a Distance Learning Online Class.

How to Begin Course: Log into Canvas through <http://myportal.mtsac.edu> and click on CRN for your DL course. **NOTE:** Some courses may not be activated until the start of the term. If you cannot locate your DL course in Canvas when the term starts, contact the professor. **On the first day of classes, log into your DL course to show your "attendance" because not doing so could result in your being dropped from the class for non-attendance.**

Professor contact info: Email Professor Lane at either: DLane@mtsac.edu, through Student Detail Schedule or Canvas at MyMtSAC Portal.

Students must use their Mt. SAC e-mail account and be aware of course commitment and student expectations described at <http://www.mtsac.edu/instruction/learning/distlearn/>

To prepare for a successful online learning experience, see helpful short videos at <http://www.mtsac.edu/distancelearning/quiz/>

No cost digital textbooks or textual materials used.

42463 arrange 6.75 hours Wolde-Yohannes, S ONLINE

8 Weeks, Week beginning 02/26/2018 ending 04/22/2018**NOTE:** CRN 42463 is a Distance Learning Online Class.

How to Begin Course: Log into Canvas through <http://myportal.mtsac.edu> and click on CRN for your DL course. **NOTE:** Some courses may not be activated until the start of the term. If you cannot locate your DL course in Canvas when the term starts, contact the professor. **On the first day of classes, log into your DL course to show your "attendance" because not doing so could result in your being dropped from the class for non-attendance.**

Professor contact info: Email Professor Wolde-Yohannes at either: SWoldeYohannes@mtsac.edu, through Student Detail Schedule or Canvas at MyMtSAC Portal.

Students must use their Mt. SAC e-mail account and be aware of course commitment and student expectations described at <http://www.mtsac.edu/instruction/learning/distlearn/>

To prepare for a successful online learning experience, see helpful short videos at <http://www.mtsac.edu/distancelearning/quiz/>

42480 arrange 6.75 hours Lane, D ONLINE

8 Weeks, Week beginning 04/23/2018 ending 06/17/2018**NOTE:** CRN 42480 is a Distance Learning Online Class.

How to Begin Course: Log into Canvas through <http://myportal.mtsac.edu> and click on CRN for your DL course. **NOTE:** Some courses may not be activated until the start of the term. If you cannot locate your DL course in Canvas when the term starts, contact the professor. **On the first day of classes, log into your DL course to show your "attendance" because not doing so could result in your being dropped from the class for non-attendance.**

Professor contact info: Email Professor Lane at either: DLane@mtsac.edu, through Student Detail Schedule or Canvas at MyMtSAC Portal.

Students must use their Mt. SAC e-mail account and be aware of course commitment and student expectations described at <http://www.mtsac.edu/instruction/learning/distlearn/>

To prepare for a successful online learning experience, see helpful short videos at <http://www.mtsac.edu/distancelearning/quiz/>

No cost digital textbooks or textual materials used.

42885 arrange 6.75 hours Wolde-Yohannes, S ONLINE

8 Weeks, Week beginning 04/23/2018 ending 06/17/2018**NOTE:** CRN 42885 is a Distance Learning Online Class.

How to Begin Course: Log into Canvas through <http://myportal.mtsac.edu> and click on CRN for your DL course. **NOTE:** Some courses may not be activated until the start of the term. If you cannot locate your DL course in Canvas when the term starts, contact the professor. **On the first day of classes, log into your DL course to show your "attendance" because not doing so could result in your being dropped from the class for non-attendance.**

Professor contact info: Email Professor Wolde-Yohannes at either: SWoldeYohannes@mtsac.edu, through Student Detail Schedule or Canvas at MyMtSAC Portal.

Students must use their Mt. SAC e-mail account and be aware of course commitment and student expectations described at <http://www.mtsac.edu/instruction/learning/distlearn/>

To prepare for a successful online learning experience, see helpful short videos at <http://www.mtsac.edu/distancelearning/quiz/>

42886 arrange 6.75 hours Henry, D ONLINE

8 Weeks, Week beginning 04/23/2018 ending 06/17/2018**NOTE:** CRN 42886 is a Distance Learning Online Class.

How to Begin Course: Log into Canvas through <http://myportal.mtsac.edu> and click on CRN for your DL course. **NOTE:** Some courses may not be activated until the start of the term. If you cannot locate your DL course in Canvas when the term starts, contact the professor. **On the first day of classes, log into your DL course to show your "attendance" because not doing so could result in your being dropped from the class for non-attendance.**

Professor contact info: Email Professor Henry at either: DHenry@mtsac.edu, through Student Detail Schedule or Canvas at MyMtSAC Portal.

Students must use their Mt. SAC e-mail account and be aware of course commitment and student expectations described at <http://www.mtsac.edu/instruction/learning/distlearn/>

To prepare for a successful online learning experience, see helpful short videos at <http://www.mtsac.edu/distancelearning/quiz/>

43074 arrange 6.75 hours Park, J ONLINE

8 Weeks, Week beginning 04/23/2018 ending 06/17/2018**NOTE:** CRN 43074 is a Distance Learning Online Class.

How to Begin Course: Log into Canvas through <http://myportal.mtsac.edu> and click on CRN for your DL course. **NOTE:** Some courses may not be activated until the start of the term. If you cannot locate your DL course in Canvas when the term starts, contact the professor. **On the first day of classes, log into your DL course to show your "attendance" because not doing so could result in your being dropped from the class for non-attendance.**

Professor contact info: Email Professor Park at either: JSPark@mtsac.edu, through Student Detail Schedule or Canvas at MyMtSAC Portal.

Students must use their Mt. SAC e-mail account and be aware of course commitment and student expectations described at <http://www.mtsac.edu/instruction/learning/distlearn/>

To prepare for a successful online learning experience, see helpful short videos at <http://www.mtsac.edu/distancelearning/quiz/>

44163 arrange 6.75 hours Ramal, R ONLINE

8 Weeks, Week beginning 04/23/2018 ending 06/17/2018**NOTE:** CRN 44163 is a Distance Learning Online Class.

How to Begin Course: Log into Canvas through <http://myportal.mtsac.edu> and click on CRN for your DL course. **NOTE:** Some courses may not be activated until the start of the term. If you cannot locate your DL course in Canvas when the term starts, contact the professor. **On the first day of classes, log into your DL course to show your "attendance" because not doing so could result in your being dropped from the class for non-attendance.**

Professor contact info: Email Professor Ramal at either: RRamal@mtsac.edu, through Student Detail Schedule or Canvas at MyMtSAC Portal.

Students must use their Mt. SAC e-mail account and be aware of course commitment and student expectations described at <http://www.mtsac.edu/instruction/learning/distlearn/>

To prepare for a successful online learning experience, see helpful short videos at <http://www.mtsac.edu/distancelearning/quiz/>

■ PHIL 8 — Critical Thinking 3.0 Units

Effective use of critical thinking in contemporary living, including recognizing faulty arguments and avoiding common fallacies.

42464 arrange 6.75 hours Lane, D ONLINE

8 Weeks, Week beginning 02/26/2018 ending 04/22/2018**NOTE:** CRN 42464 is a Distance Learning Online Class.

How to Begin Course: Log into Canvas through <http://myportal.mtsac.edu> and click on CRN for your DL course. **NOTE:** Some courses may not be activated until the start of the term. If you cannot locate your DL course in Canvas when the term starts, contact the professor. **On the first day of classes, log into your DL course to show your "attendance" because not doing so could result in your being dropped from the class for non-attendance.**

Professor contact info: Email Professor Lane at either: DLane@mtsac.edu, through Student Detail Schedule or Canvas at MyMtSAC Portal.

Students must use their Mt. SAC e-mail account and be aware of course commitment and student expectations described at <http://www.mtsac.edu/instruction/learning/distlearn/>

To prepare for a successful online learning experience, see helpful short videos at <http://www.mtsac.edu/distancelearning/quiz/>

No cost digital textbooks or textual materials used.

42594 arrange 6.75 hours Park, J ONLINE

8 Weeks, Week beginning 04/23/2018 ending 06/17/2018**NOTE:** CRN 42594 is a Distance Learning Online Class.

How to Begin Course: Log into Canvas through <http://myportal.mtsac.edu> and click on CRN for your DL course. **NOTE:** Some courses may not be activated until the start of the term. If you cannot locate your DL course in Canvas when the term starts, contact the professor. **On the first day of classes, log into your DL course to show your "attendance" because not doing so could result in your being dropped from the class for non-attendance.**

Professor contact info: Email Professor Park at either: JSPark@mtsac.edu, through Student Detail Schedule or Canvas at MyMtSAC Portal.

Students must use their Mt. SAC e-mail account and be aware of course commitment and student expectations described at <http://www.mtsac.edu/instruction/learning/distlearn/>

To prepare for a successful online learning experience, see helpful short videos at <http://www.mtsac.edu/distancelearning/quiz/>

■ PHIL 9 — Critical Thinking and Writing 3.0 Units

Function and use of formal and informal logic, argument, critical evaluation, and language in written composition.

42465 arrange 6.75 hours Stowell, A ONLINE

8 Weeks, Week beginning 02/26/2018 ending 04/22/2018**NOTE:** CRN 42465 is a Distance Learning Online Class.

How to Begin Course: Log into Canvas through <http://myportal.mtsac.edu> and click on CRN for your DL course. **NOTE:** Some courses may not be activated until the start of the term. If you cannot locate your DL course in Canvas when the term starts, contact the professor. **On the first day of classes, log into your DL course to show your "attendance" because not doing so could result in your being dropped from the class for non-attendance.**

Professor contact info: Email Professor Stowell at either: AStowell@mtsac.edu, through Student Detail Schedule or Canvas at MyMtSAC Portal.

Students must use their Mt. SAC e-mail account and be aware of course commitment and student expectations described at <http://www.mtsac.edu/instruction/learning/distlearn/>

To prepare for a successful online learning experience, see helpful short videos at <http://www.mtsac.edu/distancelearning/quiz/>

42887 arrange 6.75 hours Stowell, A ONLINE

8 Weeks, Week beginning 04/23/2018 ending 06/17/2018**NOTE:** CRN 42887 is a Distance Learning Online Class.

How to Begin Course: Log into Canvas through <http://myportal.mtsac.edu> and click on CRN for your DL course. **NOTE:** Some courses may not be activated until the start of the term. If you cannot locate your DL course in Canvas when the term starts, contact the professor. **On the first day of classes, log into your DL course to show your "attendance" because not doing so could result in your being dropped from the class for non-attendance.**

Professor contact info: Email Professor Stowell at either: AStowell@mtsac.edu, through Student Detail Schedule or Canvas at MyMtSAC Portal.

Students must use their Mt. SAC e-mail account and be aware of course commitment and student expectations described at <http://www.mtsac.edu/instruction/learning/distlearn/>

To prepare for a successful online learning experience, see helpful short videos at <http://www.mtsac.edu/distancelearning/quiz/>

44184 arrange 6.75 hours Henry, D ONLINE

8 Weeks, Week beginning 04/23/2018 ending 06/17/2018**NOTE:** CRN 44184 is a Distance Learning Online Class.

How to Begin Course: Log into Canvas through <http://myportal.mtsac.edu> and click on CRN for your DL course. **NOTE:** Some courses may not be activated until the start of the term. If you cannot locate your DL course in Canvas when the term starts, contact the professor. **On the first day of classes, log into your DL course to show your "attendance" because not doing so could result in your being dropped from the class for non-attendance.**

Professor contact info: Email Professor Henry at either: DHenry@mtsac.edu, through Student Detail Schedule or Canvas at MyMtSAC Portal.

Students must use their Mt. SAC e-mail account and be aware of course commitment and student expectations described at <http://www.mtsac.edu/instruction/learning/distlearn/>

To prepare for a successful online learning experience, see helpful short videos at <http://www.mtsac.edu/distancelearning/quiz/>

PHIL 12 — Introduction to Ethics 3.0 Units

Concepts of morality and values, representative ethical theories, and applications to moral problems.

42466 arrange 6.75 hours Wolde-Yohannes, S ONLINE

8 Weeks, Week beginning 04/23/2018 ending 06/17/2018**NOTE:** CRN 42466 is a Distance Learning Online Class.

How to Begin Course: Log into Canvas through <http://myportal.mtsac.edu> and click on CRN for your DL course. **NOTE:** Some courses may not be activated until the start of the term. If you cannot locate your DL course in Canvas when the term starts, contact the professor. **On the first day of classes, log into your DL course to show your "attendance" because not doing so could result in your being dropped from the class for non-attendance.**

Professor contact info: Email Professor Wolde-Yohannes at either: SWoldeYohannes@mtsac.edu, through Student Detail Schedule or Canvas at MyMtSAC Portal.

Students must use their Mt. SAC e-mail account and be aware of course commitment and student expectations described at <http://www.mtsac.edu/instruction/learning/distlearn/>

To prepare for a successful online learning experience, see helpful short videos at <http://www.mtsac.edu/distancelearning/quiz/>

42467 arrange 6.75 hours Diem, A ONLINE

8 Weeks, Week beginning 02/26/2018 ending 04/22/2018**NOTE:** CRN 42467 is a Distance Learning Online Class.

How to Begin Course: Log into Canvas through <http://myportal.mtsac.edu> and click on CRN for your DL course. **NOTE:** Some courses may not be activated until the start of the term. If you cannot locate your DL course in Canvas when the term starts, contact the professor. **On the first day of classes, log into your DL course to show your "attendance" because not doing so could result in your being dropped from the class for non-attendance.**

Professor contact info: Email Professor Diem at either: ADiem@mtsac.edu, through Student Detail Schedule or Canvas at MyMtSAC Portal.

Students must use their Mt. SAC e-mail account and be aware of course commitment and student expectations described at <http://www.mtsac.edu/instruction/learning/distlearn/>

To prepare for a successful online learning experience, see helpful short videos at <http://www.mtsac.edu/distancelearning/quiz/>

No cost digital textbooks or textual materials used.

PHIL 15 — Major World Religions 3.0 Units

History, doctrines, and practices of the major world religions. Off-campus assignments are required.

42468 arrange 6.75 hours Diem, A ONLINE

8 Weeks, Week beginning 02/26/2018 ending 04/22/2018**NOTE:** CRN 42468 is a Distance Learning Online Class.

How to Begin Course: Log into Canvas through <http://myportal.mtsac.edu> and click on CRN for your DL course. **NOTE:** Some courses may not be activated until the start of the term. If you cannot locate your DL course in Canvas when the term starts, contact the professor. **On the first day of classes, log into your DL course to show your "attendance" because not doing so could result in your being dropped from the class for non-attendance.**

Professor contact info: Email Professor Diem at either: ADiem@mtsac.edu, through Student Detail Schedule or Canvas at MyMtSAC Portal.

Students must use their Mt. SAC e-mail account and be aware of course commitment and student expectations described at <http://www.mtsac.edu/instruction/learning/distlearn/>

To prepare for a successful online learning experience, see helpful short videos at <http://www.mtsac.edu/distancelearning/quiz/>

No cost digital textbooks or textual materials used.

42469 arrange 6.75 hours Diem, A ONLINE

8 Weeks, Week beginning 02/26/2018 ending 04/22/2018**NOTE:** No cost digital textbooks or textual materials used.

42888 arrange 6.75 hours Stowell, A ONLINE

8 Weeks, Week beginning 04/23/2018 ending 06/17/2018**NOTE:** CRN 42888 is a Distance Learning Online Class.

How to Begin Course: Log into Canvas through <http://myportal.mtsac.edu> and click on CRN for your DL course. **NOTE:** Some courses may not be activated until the start of the term. If you cannot locate your DL course in Canvas when the term starts, contact the professor. **On the first day of classes, log into your DL course to show your "attendance" because not doing so could result in your being dropped from the class for non-attendance.**

Professor contact info: Email Professor Stowell at either: AStowell@mtsac.edu, through Student Detail Schedule or Canvas at MyMtSAC Portal.

Students must use their Mt. SAC e-mail account and be aware of course commitment and student expectations described at <http://www.mtsac.edu/instruction/learning/distlearn/>

To prepare for a successful online learning experience, see helpful short videos at <http://www.mtsac.edu/distancelearning/quiz/>

PHOTOGRAPHY

PHOT 5 — Digital Cameras and Composition 1.0 Unit

Use of digital cameras and image editing software. Camera required after first class meeting. Field trip required.

43932 F 03/02 6:00pm - 8:05pm Schaedel, J 13-1430

and S 03/03 9:00am - 4:50pm Schaedel, J 13-1430

and Su 03/04 9:00am - 4:50pm Schaedel, J 13-1430

1 Weeks, Week beginning 02/26/2018 ending 03/04/2018

PSYCHOLOGY

■ PSYC 14 — Developmental Psychology 3.0 Units

Psychological principles across the lifespan. This course does not fulfill Title 22 requirements for Child Development majors.

44195 arrange 6.75 hours Fell, D ONLINE

8 Weeks, Week beginning 04/22/2018 ending 06/17/2018

NOTE: CRN 44195 is a Distance Learning Online Class.

How to Begin Course: Log into Canvas through <http://myportal.mtsac.edu> and click on CRN for your DL course. **NOTE:** Some courses may not be activated until the start of the term. If you cannot locate your DL course in Canvas when the term starts, contact the professor. **On the first day of classes, log into your DL course to show your "attendance" because not doing so could result in your being dropped from the class for non-attendance.**

Professor contact info: Email Professor Fell at either: DFell@mtsac.edu, through Student Detail Schedule or Canvas at MyMtSAC Portal.

Students must use their Mt. SAC e-mail account and be aware of course commitment and student expectations described at <http://www.mtsac.edu/instruction/learning/distlearn/>

To prepare for a successful online learning experience, see helpful short videos at <http://www.mtsac.edu/distancelearning/quiz/>

■ PSYC 19 — Abnormal Psychology 3.0 Units

Students will be familiarized with psychological, biological, and sociocultural approaches to understanding abnormal behavior.

44201 arrange 6.75 hours Louie, C ONLINE

8 Weeks, Week beginning 04/23/2018 ending 06/17/2018

NOTE: CRN 44201 is a Distance Learning Online Class.

How to Begin Course: Log into Canvas through <http://myportal.mtsac.edu> and click on CRN for your DL course. **NOTE:** Some courses may not be activated until the start of the term. If you cannot locate your DL course in Canvas when the term starts, contact the professor. **On the first day of classes, log into your DL course to show your "attendance" because not doing so could result in your being dropped from the class for non-attendance.**

Professor contact info: Email Professor Louie at either: CLouie@mtsac.edu, through Student Detail Schedule or Canvas at MyMtSAC Portal.

Students must use their Mt. SAC e-mail account and be aware of course commitment and student expectations described at <http://www.mtsac.edu/instruction/learning/distlearn/>

To prepare for a successful online learning experience, see helpful short videos at <http://www.mtsac.edu/distancelearning/quiz/>

RADIOLOGIC TECHNOLOGY

■ RAD 40 — Mammography Principles and Procedures 3.0 Units

Advanced course designed to provide the skills to become California state certified in Mammographic Radiologic Technology

41577 MW 6:00pm - 8:20pm Neel, M 67A-150

12 Weeks, Week beginning 02/26/2018 ending 05/20/2018

SOCIOLOGY

■ SOC 1 — Sociology 3.0 Units

Study of human relations and social structure emphasizing the interaction between personality, culture and society.

42470 arrange 6.75 hours Gallarde, M ONLINE

8 Weeks, Week beginning 02/26/2018 ending 04/22/2018

NOTE: CRN 42470 is a Distance Learning Online Class.

How to Begin Course: Log into Canvas through <http://myportal.mtsac.edu> and click on CRN for your DL course. **NOTE:** Some courses may not be activated until the start of the term. If you cannot locate your DL course in Canvas when the term starts, contact the professor. **On the first day of classes, log into your DL course to show your "attendance" because not doing so could result in your being dropped from the class for non-attendance.**

Professor contact info: Email Professor Gallarde at either: MGallarde@mtsac.edu, through Student Detail Schedule or Canvas at MyMtSAC Portal.

Students must use their Mt. SAC e-mail account and be aware of course commitment and student expectations described at <http://www.mtsac.edu/instruction/learning/distlearn/>

To prepare for a successful online learning experience, see helpful short videos at <http://www.mtsac.edu/distancelearning/quiz/>

No cost digital textbooks or textual materials used.

42471 arrange 6.75 hours Gallarde, M ONLINE

8 Weeks, Week beginning 02/26/2018 ending 04/22/2018

NOTE: CRN 42471 is a Distance Learning Online Class.

How to Begin Course: Log into Canvas through <http://myportal.mtsac.edu> and click on CRN for your DL course. **NOTE:** Some courses may not be activated until the start of the term. If you cannot locate your DL course in Canvas when the term starts, contact the professor. **On the first day of classes, log into your DL course to show your "attendance" because not doing so could result in your being dropped from the class for non-attendance.**

Professor contact info: Email Professor Gallarde at either: MGallarde@mtsac.edu, through Student Detail Schedule or Canvas at MyMtSAC Portal.

Students must use their Mt. SAC e-mail account and be aware of course commitment and student expectations described at <http://www.mtsac.edu/instruction/learning/distlearn/>

To prepare for a successful online learning experience, see helpful short videos at <http://www.mtsac.edu/distancelearning/quiz/>

No cost digital textbooks or textual materials used.

42472 arrange 6.75 hours Gallarde, M ONLINE

8 Weeks, Week beginning 02/26/2018 ending 04/23/2018

NOTE: CRN 42472 is a Distance Learning Online Class.

How to Begin Course: Log into Canvas through <http://myportal.mtsac.edu> and click on CRN for your DL course. **NOTE:** Some courses may not be activated until the start of the term. If you cannot locate your DL course in Canvas when the term starts, contact the professor. **On the first day of classes, log into your DL course to show your "attendance" because not doing so could result in your being dropped from the class for non-attendance.**

Professor contact info: Email Professor Gallarde at either: MGallarde@mtsac.edu, through Student Detail Schedule or Canvas at MyMtSAC Portal.

Students must use their Mt. SAC e-mail account and be aware of course commitment and student expectations described at <http://www.mtsac.edu/instruction/learning/distlearn/>

To prepare for a successful online learning experience, see helpful short videos at <http://www.mtsac.edu/distancelearning/quiz/>

No cost digital textbooks or textual materials used.

42473 arrange 6.75 hours Hernandez-Magallon, K ONLINE
8 Weeks, Week beginning 02/26/2018 ending 04/23/2018

NOTE: CRN 42473 is a Distance Learning Online Class.

How to Begin Course: Log into Canvas through <http://myportal.mtsac.edu> and click on CRN for your DL course. **NOTE:** Some courses may not be activated until the start of the term. If you cannot locate your DL course in Canvas when the term starts, contact the professor. **On the first day of classes, log into your DL course to show your "attendance" because not doing so could result in your being dropped from the class for non-attendance.**

Professor contact info: Email Professor Hernandez-Magallon at either: KHernandezMagallon@mtsac.edu, through Student Detail Schedule or Canvas at MyMtSAC Portal.

Students must use their Mt. SAC e-mail account and be aware of course commitment and student expectations described at <http://www.mtsac.edu/instruction/learning/distlearn/>

To prepare for a successful online learning experience, see helpful short videos at <http://www.mtsac.edu/distancelearning/quiz/>

No cost digital textbooks or textual materials used.

43067 arrange 6.75 hours Hernandez-Magallon, K ONLINE
8 Weeks, Week beginning 04/23/2018 ending 06/17/2018

NOTE: CRN 43067 is a Distance Learning Online Class.

How to Begin Course: Log into Canvas through <http://myportal.mtsac.edu> and click on CRN for your DL course. **NOTE:** Some courses may not be activated until the start of the term. If you cannot locate your DL course in Canvas when the term starts, contact the professor. **On the first day of classes, log into your DL course to show your "attendance" because not doing so could result in your being dropped from the class for non-attendance.**

Professor contact info: Email Professor Hernandez-Magallon at either: KHernandezMagallon@mtsac.edu, through Student Detail Schedule or Canvas at MyMtSAC Portal.

Students must use their Mt. SAC e-mail account and be aware of course commitment and student expectations described at <http://www.mtsac.edu/instruction/learning/distlearn/>

To prepare for a successful online learning experience, see helpful short videos at <http://www.mtsac.edu/distancelearning/quiz/>

No cost digital textbooks or textual materials used.

43070 arrange 6.75 hours Ramirez, C ONLINE
8 Weeks, Week beginning 04/23/2018 ending 06/17/2018

NOTE: CRN 43070 is a Distance Learning Online Class.

How to Begin Course: Log into Canvas through <http://myportal.mtsac.edu> and click on CRN for your DL course. **NOTE:** Some courses may not be activated until the start of the term. If you cannot locate your DL course in Canvas when the term starts, contact the professor. **On the first day of classes, log into your DL course to show your "attendance" because not doing so could result in your being dropped from the class for non-attendance.**

Professor contact info: Email Professor Quach at either: CQuach2@mtsac.edu, through Student Detail Schedule or Canvas at MyMtSAC Portal.

Students must use their Mt. SAC e-mail account and be aware of course commitment and student expectations described at <http://www.mtsac.edu/instruction/learning/distlearn/>

To prepare for a successful online learning experience, see helpful short videos at <http://www.mtsac.edu/distancelearning/quiz/>

No cost digital textbooks or textual materials used.

■ **SOC 2 — Contemporary Social Problems** **3.0 Units**

Basic sociological principles and concepts to the study and understanding of social problems.

42597 arrange 6.75 hours Morales Beasley, S ONLINE
8 Weeks, Week beginning 04/23/2018 ending 06/17/2018

NOTE: CRN 42597 is a Distance Learning Online Class.

How to Begin Course: Log into Canvas through <http://myportal.mtsac.edu> and click on CRN for your DL course. **NOTE:** Some courses may not be activated until the start of the term. If you cannot locate your DL course in Canvas when the term starts, contact the professor. **On the first day of classes, log into your DL course to show your "attendance" because not doing so could result in your being dropped from the class for non-attendance.**

Professor contact info: Email Professor Morales Beasley at either: SMorales2@mtsac.edu, through Student Detail Schedule or Canvas at MyMtSAC Portal.

Students must use their Mt. SAC e-mail account and be aware of course commitment and student expectations described at <http://www.mtsac.edu/instruction/learning/distlearn/>

To prepare for a successful online learning experience, see helpful short videos at <http://www.mtsac.edu/distancelearning/quiz/>

■ **SOC 5 — Introduction to Criminology** **3.0 Units**

A scientific analysis of violations of societal rules of behavior that are formally defined as crime and delinquency.

42552 arrange 6.75 hours Irvine, C ONLINE
8 Weeks, Week beginning 04/23/2018 ending 06/17/2018

NOTE: CRN 42552 is a Distance Learning Online Class.

How to Begin Course: Log into Moodlerooms through <http://myportal.mtsac.edu> and click on CRN for your DL course. **NOTE:** Some courses may not be activated until the start of the term. If you cannot locate your DL course in Moodlerooms when the term starts, contact the professor. **On the first day of classes, log into your DL course to show your "attendance" because not doing so could result in your being dropped from the class for non-attendance.**

Professor contact info: Email Professor Irvine at either: CIrvine@mtsac.edu, through Student Detail Schedule or Moodlerooms at MyMtSAC Portal.

Students must use their Mt. SAC e-mail account and be aware of course commitment and student expectations described at <http://www.mtsac.edu/instruction/learning/distlearn/>

To prepare for a successful online learning experience, see helpful short videos at <http://www.mtsac.edu/distancelearning/quiz/>

42559 arrange 6.75 hours Tolmasov, B ONLINE
8 Weeks, Week beginning 02/26/2018 ending 04/22/2018

NOTE: CRN 42559 is a Distance Learning Online Class.

How to Begin Course: Log into Canvas through <http://myportal.mtsac.edu> and click on CRN for your DL course. **NOTE:** Some courses may not be activated until the start of the term. If you cannot locate your DL course in Canvas when the term starts, contact the professor. **On the first day of classes, log into your DL course to show your "attendance" because not doing so could result in your being dropped from the class for non-attendance.**

Professor contact info: Email Professor Tolmasov at either: BTolmasov@mtsac.edu, through Student Detail Schedule or Canvas at MyMtSAC Portal.

Students must use their Mt. SAC e-mail account and be aware of course commitment and student expectations described at <http://www.mtsac.edu/instruction/learning/distlearn/>

To prepare for a successful online learning experience, see helpful short videos at <http://www.mtsac.edu/distancelearning/quiz/>

42560 arrange 6.75 hours Sanchez, I ONLINE

8 Weeks, Week beginning 02/26/2018 ending 04/22/2018**NOTE:** CRN 42560 is a Distance Learning Online Class.

How to Begin Course: Log into Canvas through <http://myportal.mtsac.edu> and click on CRN for your DL course. **NOTE:** Some courses may not be activated until the start of the term. If you cannot locate your DL course in Canvas when the term starts, contact the professor. **On the first day of classes, log into your DL course to show your "attendance" because not doing so could result in your being dropped from the class for non-attendance.**

Professor contact info: Email Professor Sanchez at either: ISanchez47@mtsac.edu, through Student Detail Schedule or Canvas at MyMtSAC Portal.

Students must use their Mt. SAC e-mail account and be aware of course commitment and student expectations described at <http://www.mtsac.edu/instruction/learning/distlearn/>

To prepare for a successful online learning experience, see helpful short videos at <http://www.mtsac.edu/distancelearning/quiz/>

43062 arrange 6.75 hours Moss, J ONLINE

8 Weeks, Week beginning 04/23/2018 ending 06/17/2018**NOTE:** CRN 43062 is a Distance Learning Online Class.

How to Begin Course: Log into Moodlerooms through <http://myportal.mtsac.edu> and click on CRN for your DL course. **NOTE:** Some courses may not be activated until the start of the term. If you cannot locate your DL course in Moodlerooms when the term starts, contact the professor. **On the first day of classes, log into your DL course to show your "attendance" because not doing so could result in your being dropped from the class for non-attendance.**

Professor contact info: Email Professor Moss at either: JMoss9@mtsac.edu, through Student Detail Schedule or Moodlerooms at MyMtSAC Portal.

Students must use their Mt. SAC e-mail account and be aware of course commitment and student expectations described at <http://www.mtsac.edu/instruction/learning/distlearn/>

To prepare for a successful online learning experience, see helpful short videos at <http://www.mtsac.edu/distancelearning/quiz/>

43068 arrange 6.75 hours Moss, J ONLINE

8 Weeks, Week beginning 04/23/2018 ending 06/17/2018**NOTE:** CRN 43068 is a Distance Learning Online Class.

How to Begin Course: Log into Moodlerooms through <http://myportal.mtsac.edu> and click on CRN for your DL course. **NOTE:** Some courses may not be activated until the start of the term. If you cannot locate your DL course in Moodlerooms when the term starts, contact the professor. **On the first day of classes, log into your DL course to show your "attendance" because not doing so could result in your being dropped from the class for non-attendance.**

Professor contact info: Email Professor Moss at either: JMoss9@mtsac.edu, through Student Detail Schedule or Moodlerooms at MyMtSAC Portal.

Students must use their Mt. SAC e-mail account and be aware of course commitment and student expectations described at <http://www.mtsac.edu/instruction/learning/distlearn/>

To prepare for a successful online learning experience, see helpful short videos at <http://www.mtsac.edu/distancelearning/quiz/>

43069 arrange 6.75 hours Ramirez, C ONLINE

8 Weeks, Week beginning 04/23/2018 ending 06/17/2018**NOTE:** CRN 43069 is a Distance Learning Online Class.

How to Begin Course: Log into Canvas through <http://myportal.mtsac.edu> and click on CRN for your DL course. **NOTE:** Some courses may not be activated until the start of the term. If you cannot locate your DL course in Canvas when the term starts, contact the professor. **On the first day of classes, log into your DL course to show your "attendance" because not doing so could result in your being dropped from the class for non-attendance.**

Professor contact info: Email Professor Quach at either: CQuach2@mtsac.edu, through Student Detail Schedule or Canvas at MyMtSAC Portal.

Students must use their Mt. SAC e-mail account and be aware of course commitment and student expectations described at <http://www.mtsac.edu/instruction/learning/distlearn/>

To prepare for a successful online learning experience, see helpful short videos at <http://www.mtsac.edu/distancelearning/quiz/>

43075 arrange 6.75 hours Tolmasov, B ONLINE

8 Weeks, Week beginning 04/23/2018 ending 06/17/2018**NOTE:** CRN 43075 is a Distance Learning Online Class.

How to Begin Course: Log into Moodlerooms through <http://myportal.mtsac.edu> and click on CRN for your DL course. **NOTE:** Some courses may not be activated until the start of the term. If you cannot locate your DL course in Moodlerooms when the term starts, contact the professor. **On the first day of classes, log into your DL course to show your "attendance" because not doing so could result in your being dropped from the class for non-attendance.**

Professor contact info: Email Professor Tolmasov at either: BTolmasov@mtsac.edu, through Student Detail Schedule or Moodlerooms at MyMtSAC Portal.

Students must use their Mt. SAC e-mail account and be aware of course commitment and student expectations described at <http://www.mtsac.edu/instruction/learning/distlearn/>

To prepare for a successful online learning experience, see helpful short videos at <http://www.mtsac.edu/distancelearning/quiz/>

■ SOC 7 — Sociology of Religion 3.0 Units

Analysis of religion as a social institution. The influence of religion on American society. Field trips may be required.

42561 arrange 6.75 hours Morales Beasley, S ONLINE

8 Weeks, Week beginning 02/26/2018 ending 04/22/2018**NOTE:** CRN 42561 is a Distance Learning Online Class.

How to Begin Course: Log into Canvas through <http://myportal.mtsac.edu> and click on CRN for your DL course. **NOTE:** Some courses may not be activated until the start of the term. If you cannot locate your DL course in Canvas when the term starts, contact the professor. **On the first day of classes, log into your DL course to show your "attendance" because not doing so could result in your being dropped from the class for non-attendance.**

Professor contact info: Email Professor Morales Beasley at either: SMorales2@mtsac.edu, through Student Detail Schedule or Canvas at MyMtSAC Portal.

Students must use their Mt. SAC e-mail account and be aware of course commitment and student expectations described at <http://www.mtsac.edu/instruction/learning/distlearn/>

To prepare for a successful online learning experience, see helpful short videos at <http://www.mtsac.edu/distancelearning/quiz/>

■ SOC 14 — Marriage and the Family 3.0 Units

Sociological functions of dating, engagement, weddings, marriage, and the family.

42475 arrange 6.75 hours VanderVis, M ONLINE
8 Weeks, Week beginning 02/26/2018 ending 04/22/2018

NOTE: CRN 42474 is a Distance Learning Online Class.

How to Begin Course: Log into Moodlerooms through <http://myportal.mtsac.edu> and click on CRN for your DL course. **NOTE:** Some courses may not be activated until the start of the term. If you cannot locate your DL course in Moodlerooms when the term starts, contact the professor. **On the first day of classes, log into your DL course to show your "attendance" because not doing so could result in your being dropped from the class for non-attendance.**

Professor contact info: Email Professor Vandervis at either: MVandervis@mtsac.edu, through Student Detail Schedule or Moodlerooms at MyMtSAC Portal.

Students must use their Mt. SAC e-mail account and be aware of course commitment and student expectations described at <http://www.mtsac.edu/instruction/learning/distlearn/>

To prepare for a successful online learning experience, see helpful short videos at <http://www.mtsac.edu/distancelearning/quiz/>

No cost digital textbooks or textual materials used.

42599 arrange 6.75 hours Montero, S ONLINE
8 Weeks, Week beginning 02/26/2018 ending 04/22/2018

NOTE: CRN 42599 is a Distance Learning Online Class.

How to Begin Course: Log into Moodlerooms through <http://myportal.mtsac.edu> and click on CRN for your DL course. **NOTE:** Some courses may not be activated until the start of the term. If you cannot locate your DL course in Moodlerooms when the term starts, contact the professor. **On the first day of classes, log into your DL course to show your "attendance" because not doing so could result in your being dropped from the class for non-attendance.**

Professor contact info: Email Professor Montero at either: SMontero@mtsac.edu, through Student Detail Schedule or Moodlerooms at MyMtSAC Portal.

Students must use their Mt. SAC e-mail account and be aware of course commitment and student expectations described at <http://www.mtsac.edu/instruction/learning/distlearn/>

To prepare for a successful online learning experience, see helpful short videos at <http://www.mtsac.edu/distancelearning/quiz/>

■ SOC 15 — Child Development 3.0 Units

Theoretical aspects of development from conception through adolescence. Requires observation of children.

42476 arrange 6.75 hours Howey, D ONLINE
8 Weeks, Week beginning 02/26/2018 ending 04/22/2018

NOTE: CRN 42476 is a Distance Learning Online Class.

How to Begin Course: Log into Moodlerooms through <http://myportal.mtsac.edu> and click on CRN for your DL course. **NOTE:** Some courses may not be activated until the start of the term. If you cannot locate your DL course in Moodlerooms when the term starts, contact the professor. **On the first day of classes, log into your DL course to show your "attendance" because not doing so could result in your being dropped from the class for non-attendance.**

Professor contact info: Email Professor Howey at either: DHowey@mtsac.edu, through Student Detail Schedule or Moodlerooms at MyMtSAC Portal.

Students must use their Mt. SAC e-mail account and be aware of course commitment and student expectations described at <http://www.mtsac.edu/instruction/learning/distlearn/>

To prepare for a successful online learning experience, see helpful short videos at <http://www.mtsac.edu/distancelearning/quiz/>

■ SOC 20 — Sociology of Ethnic Relations 3.0 Units

Ethnic and racial groups in the U.S. and social factors leading to prejudice, discrimination, and stereotypes.

42478 arrange 6.75 hours Hernandez-Magallon, K ONLINE
8 Weeks, Week beginning 02/26/2018 ending 04/22/2018

NOTE: CRN 42478 is a Distance Learning Online Class.

How to Begin Course: Log into Canvas through <http://myportal.mtsac.edu> and click on CRN for your DL course. **NOTE:** Some courses may not be activated until the start of the term. If you cannot locate your DL course in Canvas when the term starts, contact the professor. **On the first day of classes, log into your DL course to show your "attendance" because not doing so could result in your being dropped from the class for non-attendance.**

Professor contact info: Email Professor Hernandez-Magallon at either: KHernandezMagallon@mtsac.edu, through Student Detail Schedule or Canvas at MyMtSAC Portal.

Students must use their Mt. SAC e-mail account and be aware of course commitment and student expectations described at <http://www.mtsac.edu/instruction/learning/distlearn/>

To prepare for a successful online learning experience, see helpful short videos at <http://www.mtsac.edu/distancelearning/quiz/>

SPANISH
■ SPAN 1 — Elementary Spanish 4.0 Units

Conversing, reading, and writing in Spanish at the elementary level.

42980 TTh 9:45am - 2:00pm Kemp, K 66-248
8 Weeks, Week beginning 02/26/2018 ending 04/22/2018

■ SPAN 2 — Continuing Elementary Spanish 4.0 Units

Further development of conversational, reading, and writing skills in Spanish. Further study of Hispanic culture.

43000 TTh 9:45am - 2:00pm Kemp, K 66-248
8 Weeks, Week beginning 04/23/2018 ending 06/17/2018

SPEECH
■ SPCH 1A — Public Speaking 4.0 Units

Study and apply rhetorical principles to research, write outlines, and deliver speeches. Credit for either SPCH 1A or SPCH 1AH.

42351 MTWTh 9:45am - 11:50am Ferguson, C 26A-1881
8 Weeks, Week beginning 02/26/2018 ending 04/22/2018

■ SPCH 7 — Intercultural Communication 3.0 Units

Theoretical dynamics of culture within communication contexts. Students may not receive credit for both SPCH 7 and SPCH 7H.

42371 TWTh 9:45am - 11:50am Arntson, R 26A-1881
8 Weeks, Week beginning 04/23/2018 ending 06/17/2018

NOTE: No cost digital textbooks or textual materials used.

■ SPCH 16 — Forensics: Individual Event Team 3.0 Units

Participation in multiple intercollegiate speaking competitions with the Mt. SAC Forensics Team. Tournament attendance required.

42617 T 4:30pm - 6:35pm Willis, R 26D-1441
 and arrange 11.75 hours Cantrell, D 26D-1441
12 Weeks, Week beginning 02/26/2018 ending 05/20/2018

NOTE: For audition information, email forensics@mtsac.edu.

■ SPCH 18 — Forensics: Reader's Theater Team 3.0 Units

Performance of readers theater as part of Mt. SAC's Forensics Team. Required participation in readers theater competition.

42374 T 7:00pm - 10:10pm McLeod, J 26D-1441
 and arrange 10.75 hours Klawitter, K 26D-1441
12 Weeks, Week beginning 02/26/2018 ending 05/20/2018

STUDY TECHNIQUES

■ **STDY 85C — Online Learning Success Skills** 1.0 Unit

College success course for online learning using a brain-based perspective emphasizing introductory skills necessary.

43660 arrange 2.25 hours Hunter-Buffington, C ONLINE
8 Weeks, Week beginning 02/26/2018 ending 04/22/2018

NOTE: CRN 43660 is a Distance Learning Online Class.

How to Begin Course: Log into Canvas through the e-Learning Tools tab in the Mt.SAC portal at inside.mtsac.edu. Then click on the Canvas link and then click on CRN for your DL course. **NOTE:** Some courses may not be activated until the start of the term. If you cannot locate your DL course in Canvas when the term starts, contact the professor. **On the first day of classes, log into your DL course to show your "attendance" because not doing so could result in your being dropped from the class for non-attendance.**

Professor contact info: Email Professor Buffington at either: CBuffington@mtsac.edu, through Student Detail Schedule or Canvas at MyMtSAC Portal.

Students must use their Mt.SAC e-mail account and be aware of course commitment and student expectations described at <http://www.mtsac.edu/distancelearning/>

To prepare for a successful online learning experience, see helpful short videos at <http://www.mtsac.edu/distancelearning/quiz/>

43668 arrange 2.25 hours Hunter-Buffington, C ONLINE
8 Weeks, Week beginning 04/23/2018 ending 06/17/2018

NOTE: CRN 43668 is a Distance Learning Online Class.

How to Begin Course: Log into Canvas through the e-Learning Tools tab in the Mt.SAC portal at inside.mtsac.edu. Then click on the Canvas link and then click on CRN for your DL course. **NOTE:** Some courses may not be activated until the start of the term. If you cannot locate your DL course in Canvas when the term starts, contact the professor. **On the first day of classes, log into your DL course to show your "attendance" because not doing so could result in your being dropped from the class for non-attendance.**

Professor contact info: Email Professor Buffington at either: CBuffington@mtsac.edu, through Student Detail Schedule or Canvas at MyMtSAC Portal.

Students must use their Mt.SAC e-mail account and be aware of course commitment and student expectations described at <http://www.mtsac.edu/distancelearning/>

To prepare for a successful online learning experience, see helpful short videos at <http://www.mtsac.edu/distancelearning/quiz/>

TECHNOLOGY-RELATED COURSES

■ **TECH 60 — Customer Relations for the Technician** 2.0 Units

Customer relations training (soft skills) for the technician.

44255 F 5:30pm - 10:00pm Uranga, J 28B-404
8 Weeks, Week beginning 02/26/2018 ending 04/22/2018

THEATER ARTS

■ **THTR 13 — Play Rehearsal and Performance - Technical** 2.0 Unit

Planning, preparation, and presentation of college-sponsored dramatic presentations. Emphasis on technical theater.

43733 MTWTh 7:00pm - 10:10pm Cummings, C 2-T130
8 Weeks, Week beginning 02/26/2018 ending 04/22/2018

43734 MTWTh 7:00pm - 10:10pm Burgos, M 2-T130
8 Weeks, Week beginning 04/23/2018 ending 06/17/2018

■ **THTR 15 — Play Rehearsal and Performance - Acting** 2.0 Unit

Presentation of college-sponsored plays. Offers acting experiences. Attendance at performances required.

43739 MTWTh 7:00pm - 10:10pm Cummings, C 2-T130
8 Weeks, Week beginning 02/26/2018 ending 04/22/2018

NOTE: CRN 43739 above holds auditions: Monday, February 26th, and Tuesday, February 27th, 2017 at 7:00 PM in 2-T130. Production: "Six Characters in Search of an Author" by Luigi Pirandello. Enrollment is contingent on a successful audition.

43740 MTWTh 7:00pm - 10:10pm Burgos, M 2-T130
8 Weeks, Week beginning 04/23/2018 ending 06/17/2018

NOTE: CRN 43740 above holds auditions: Monday, February 26th, and Tuesday, February 27th, 2017 at 7:00 PM in 2-T130. Production: "26 Pebbles" by Eric Ulloa. Enrollment is contingent on a successful audition.

2018 SPRING SCHEDULE of CONTINUING EDUCATION & Noncredit classes



This section contains only the state-funded noncredit adult education courses. All fee-based career and professional development classes, as well as youth programs, recreational, motorcycle, driver education, arts, leisure and all other "community service" programs are compiled online at <http://communityed.mtsac.edu> or call (909) 274-4220.

2018 Spring Continuing Education Registration Form

MT. SAC CONTINUING EDUCATION REGISTRATION FORM

Print Last Name		First	MI	Former / Maiden Name	Social Security # ____ / ____ / ____
Street Address <input type="checkbox"/> Check if changed in past 3 months				City	Zip
Cell # <input type="checkbox"/> Check if changed in past 3 months		Home #	Work #	Student ID # _____	
Text # <input type="checkbox"/> Check if same as cell #		E-mail Address		Date of Birth MONTH / DAY / YEAR	
				Sex <input type="checkbox"/> Female <input type="checkbox"/> Male	
Student Type		Are you a U.S. Veteran?		Do you live in California?	
X NCR Courses Only		<input type="checkbox"/> Yes <input type="checkbox"/> No		(Circle one) 1 Yes 0 No	
				F1 Visa Student? <input type="checkbox"/> Yes <input type="checkbox"/> No	
Educational Goal: (Circle one)					
A. Associate & Transfer to 4-yr		D. 2-yr Vocational Degree		G. Prep for New Career/Job Skills	
B. Transfer to 4-year w/o Asso.		E. Vocational Certificate		H. Adv in Career/Update Job Skills	
C. 2-yr Associate Degree		F. Discovery-Career Interest/Goal		I. Maintain Certificate/License	
				J. Educational Development	
				K. Improve Basic Skills	
				L. Credit for HS Diploma/GED	
				M. Undecided on Goal	
				N. Move Noncredit to Credit Coursework	
				X. Uncollected/Unreported	
Educational Level: (Circle one)					
0 Non HS Grad & not in HS		3XX High School Diploma		4XX GED/HS Cert of Equivalency	
2 Currently in Adult School		NHS Noncredit High School Student		5XX Cert of CA HS Proficiency	
				6XX Foreign School Diploma	
				7XX Received AA/AS Degree	
				8XX Received Bachelor or Higher	
				X Unknown/Unreported	
Ethnicity and Race: (Select all that apply) <small>Per U.S. Dept. of Education guidelines, colleges are required to collect the following racial and ethnic data.</small>					
Are you of Hispanic or Latino ethnicity? <input type="checkbox"/> Yes <input type="checkbox"/> No		05 Hispanic: Other		09 Asian: Korean	
02 Mexican, Mexican American, Chicano		06 Asian: Indian		10 Asian: Laotian	
03 Central American		07 Asian: Chinese		11 Asian: Cambodian	
04 South American		08 Asian: Japanese		12 Asian: Vietnamese	
				13 Asian: Filipino	
				14 Asian: Other	
				15 Black or African American	
				16 American Indian/Alaskan Native	
				17 Pacific Islander: Guamanian	
				18 Pacific Islander: Hawaiian	
				19 Pacific Islander: Samoan	
				20 Pacific Islander: Other	
				21 White	
Class Selections (List class titles)		CRN	Instructor Name	Class Time	Start Date
1.					
2.					
3.					
4.					
Student Signature: _____					
Today's Date: _____					
Number of years of school completed: _____ years					
Majority of schooling was outside of U.S.: <input type="checkbox"/> Yes <input type="checkbox"/> No					
Highest Diploma or Degree earned:					
1. None		3. High School Diploma		5. Some college, no degree	
2. HSE Certificate		4. Technical/Certificate		6. A.A./A.S. Degree	
				7. 4 yr. college graduate	
				8. Higher than B.A./B.S.	
I earned my diploma/degree outside of the U.S.: <input type="checkbox"/> Yes <input type="checkbox"/> No					
Native Language: (Circle one)					
A. English		D. Tagalog		G. Korean	
B. Spanish		E. Vietnamese		H. Hmong	
C. Chinese		F. Cambodian		I. Arabic	
				J. Russian	
				K. Farsi	
				L. Somali	
				M. Other _____	
Employment Barriers: (Select all that apply)					
A. Cultural Barriers		D. English Language Learner		G. Homeless	
B. Disabled		E. Ex-Offender		H. Long-term Unemployed	
C. Displaced Homemaker		F. Foster Care Youth		I. Low Income	
				J. Low Levels of Literacy	
				K. Migrant Farmworker	
				L. Seasonal Farmworker	
				M. Single Parent	
				N. No TANF within 2 yrs.	
Labor Force Status: (Circle One)					
A. Unemployed		B. Employed		C. Employed, with notice	
				D. Not in labor force	
Goal 1: (Circle One)					
A. Improve basic skills		D. Get a job		G. Enter college or training	
B. Improve English skills		E. Retain job		H. Work-based project	
C. H.S. Diploma/HSE		F. Get a better job		I. Family goal	
				J. U.S. Citizenship	
				K. Military	
				L. Personal goal	
				M. None	
				N. Other	
Goal 2: (Circle One)					
A. Improve basic skills		D. Get a job		G. Enter college or training	
B. Improve English skills		E. Retain job		H. Work-based project	
C. H.S. Diploma/HSE		F. Get a better job		I. Family goal	
				J. U.S. Citizenship	
				K. Military	
				L. Personal goal	
				M. None	
				N. Other	

School of Continuing Education 2018 Spring Classes

The School of Continuing Education offers a variety of adult education, personal development, job training, professional certificate and recreational programs for residents in surrounding communities. **The fee-based career and professional development courses are accessible online at <http://feeclasses.mtsac.edu> (Schedule of Classes).** You may call the School of Continuing Education office for more information about the fee-based class schedule at (909) 274-4220.

CONTENTS

Adult Basic Skills.....	190	Photography	198
High School Referral Program.....	191	Technology Training	199
Learning Assistance Center	191	Welding	199
Supervised Tutoring	191	Disabled Student Programs & Services	200
The Writing Center	192	English as a Second Language (ESL)	201
Short-Term Vocational.....	194-200	Health Careers.....	202
Administration of Justice	194	Education for Older Adults	202-207
Computer and Networking Technology	196	Locations of Off-Campus Classes	208
Electronics.....	196	Campus Map.....	210-211
General Office.....	197	Continuing Education Program Index.....	209
Interior Design.....	197		

Continuing Education Registration Instructions

This section outlines the registration and enrollment procedures for Continuing Education classes, including **Adult Education and Adult Basic Skills** courses. Please use the Continuing Education Registration Form on page 187. Registration is continuous throughout the semester, because Continuing Education classes begin and end at different times and for varying durations.

Enrollment procedures for **English as a Second Language (ESL)** classes are provided on page 201. *Please note that Adult Basic Skills and ESL students must complete the required assessment and orientation process before registering for classes. See their respective sections for details.*

ADULT ED REGISTRATION PROCEDURES

1. Register In Person

Registration is conducted in Building 40, Room 101. Enter campus at the Bonita Ave. entrance off Temple Avenue and go north into the campus. **The first day of registration is Wednesday, January 17.**

Spring Registration office hours:

MTWTh	8:00 a.m. - 7:00 p.m.
F	8:00 a.m. - 4:00 p.m.

Note: The Registration Office will be closed on Cesar Chavez Day (Friday, March 30) and Memorial Day (Monday, May 28).

Optional Job Training and Educational Advisement Service:

While registering in person you may want to take advantage of advisement service.

You can schedule a private appointment by calling: (909) 274-4845.

2. Register by Fax

- Complete all information on the Registration Form inserted in this Class Schedule, *including class title and Course Reference Number (CRN).*
- Fax the completed form to: (909) 274-2937.
- Please allow up to three business days to process fax registration.
- You will receive a "Student Schedule Printout" by mail after your registration is processed. All faxed registration forms will be held in the order received and processed beginning at 8:00 a.m. on Wednesday, Jan. 17.

3. Register by Mail

- Complete all information on the Registration Form inserted in this Class Schedule. Be sure to include the class title and reference number on the registration form.

- Mail completed form:
School of Continuing Education
Mt. San Antonio College
1100 N. Grand Ave.
Walnut, CA 91789
- A confirming “Student Schedule Printout” will be mailed to you after your registration is processed.

Note: *The registration form is included in this Class Schedule for you. All mailed-in registration forms will be held in the order received and processed beginning at 8:00 a.m. on Wednesday, January 17.*

Class Session Changes & Holidays

The School of Continuing Education reserves the right to make changes in any class. When enrollment in any class is not sufficient to justify its continuance, the class may be terminated. Class dates may change due to instructor/classroom availability.

Most classes will not be held on District holidays. Additional holidays may be observed depending upon off-campus class location. Information will be provided by the instructor.

ADULT BASIC EDUCATION REGISTRATION PROCEDURES

1. Sign Up for Orientation

- Counselors will help students select appropriate courses and programs to help students succeed in their career of choice. Counseling sessions are conducted in multiple languages. To schedule an appointment, contact the Adult Basic Education Center at (909) 274-4845.

2. Complete Assessment Process

- Noncredit students enrolling in Basic Skills programs must go through a skills assessment at the Adult Basic Education Center (Building 30) to determine appropriate course selections and to develop an Individual Educational and Career Plan.

3. Register for Classes

- Students must finish the registration process at the Adult Basic Education Center after they have completed assessment and orientation. Students may register for most classes anytime during the semester when space is available within the requested class or program.

Enrollment Fees and Expenses

- Adult Education courses and programs do not have an enrollment fee. However, a material fee may be charged for some courses, payable at the time of registration. Please see the online instructions for fee payment and policies at www.mtsac.edu/schedule.
- **Parking Fees:** Those who wish to park in the regular student parking lot need a valid Student Parking Permit, which may be purchased online in the student portal. Parking permits also are available to buy in the Bursar’s Office. Students may park in the pay lots with out a Student Parking Permit. Please see pages 210-211 for general parking information and for parking lot locations.

Support Services

- **Counseling/Advisement Services:** The Education Advisement Counseling and Assessment areas provide students with resources to explore and identify career options, practice interviewing techniques, and develop their communication and study skills. These services are offered throughout the semester. Call (909) 274-4845.
- **Tutorial Services:** Tutoring is available both in a classroom setting and at the Tutoring Center (Building 6, Room 101).

MT. SAC FARM TOURS

A guided tour of the Mt. SAC farm is available with advanced notice. Each tour is unique and can include such animals as sheep, pigs, cattle, horses, llama, emu, miniature horses, zebu (*miniature Brahma*), and Watusi (*African longhorn cattle*).

The tour takes approximately one hour. Please limit the group size to 60 people (or two classrooms of students). Tours are available at no cost; however, we would appreciate a donation to help offset the costs for the tour guides.

Please contact Campus Events at (909) 274-4794 or the Agricultural Sciences Department at (909) 274-4540, to arrange for a tour.

2018 Spring Schedule of Continuing Education Classes

ADULT BASIC SKILLS

**Adult Basic Education Center
Mt. SAC Campus, Building 30
(909) 274-4845**

Office Hours:

MTWTh: 8:00 a.m. - 4:30 p.m.

F: 8:00 a.m. - 4:00 p.m.

Dates: February 26 - June 14, 2018

**Learning Center
(909) 274-4935**

Lab Days/Hours:

MTWTh: 8:00 a.m. - 8:00 p.m.

F: 8:00 a.m. - 4:00 p.m.

**High School Office
(909) 274-4937**

Office Hours:

MTWTh: 8:00 a.m. - 8:30 p.m.

F: 8:00 a.m. - 4:00 p.m.

The Adult Basic Education Center is committed to providing basic skills instruction, high school diploma and equivalency preparation, and support services that prepare students to transition into college and/or employment. Students also receive academic assessment, career assessment, career development, academic advising, and educational planning. All services are offered at no cost and students may register at any time during the semester.

Adult Basic Education

The Adult Basic Education Lab is available to students on a walk-in basis, offering:

- Courses to strengthen reading, writing, and math
- Development of basic skills necessary for the workplace and college
- Direct instruction and individualized study plan
- Computer-based instruction and small group study
- Counseling and advising services

ASVAB Preparation

Preparation Students interested in entering the military may prepare for the Armed Services Vocational Aptitude Battery (ASVAB) in the Adult Basic Education Lab. Students will be pre-tested and prescribed an adult learning plan to cover deficient areas. Emphasis is placed on assisting student in earning the highest possible score on the official ASVAB exam.

Computer Literacy/Vocational

The Adult Basic Education Lab offers computer literacy courses in the following software applications:

- MS Windows
- MS Office (Word, Excel, PowerPoint, Access, Outlook)
- MS Publisher
- Quickbooks
- Keyboarding
- Internet Applications, Email

High School Equivalency Exam Preparation

Coursework is offered in the Adult Basic Education Lab to prepare students to pass the official General Education De-

velopment (GED) test and the High School Equivalency Test (HiSet) with the highest possible score. Faculty provide individual learning plans. A cap and gown graduation is held on the Mt. SAC campus each June to honor students receiving their California High School Equivalency Certificate.

SAT/CBEST Preparation

Prepare for college-bound exams at the Community Education Center. Long-term preparation is available through the use of the most current SAT/CBEST exam software.

Typing Test Certification

Typing tests that certify typing speed for employment applications are open to the public. The ABE Lab offers keyboarding software to assist students in increasing their typing speed prior to taking typing tests.

For more information on any of the above programs, please call the ABE Department at (909) 274-4845.

Athletes Can't Lose with WIN

The WIN program, a student athlete study center, is specifically designed to:

- Prepare students to transfer to a four-year institution
- Assist student athletes to maintain academic eligibility

Please call (909) 274-4239 for further information.

Adult High School Diploma, (909) 274-4937

Adult students can earn credits toward completion of a high school diploma under the guidance of instructors, counselors and support staff. Coursework is offered in small group instruction, computer-aided instruction and individual study. A cap and gown graduation is held on the Mt. SAC campus each June to honor students receiving their high school diploma.

Credits for required courses and/or electives may be awarded in the following ways:

- Adult School Courses (accredited institutions only)
- Previous High School Courses (accredited institutions only)
- Work Experience (verification required)
- Community College Credit Courses
- Training Programs (accredited institutions only)

Please call (909) 274-4937 for program information and to schedule an orientation appointment.

IN-HOME SUPPORT SERVICES CAREGIVER TRAINING PROGRAM SPRING 2018

This free 6-week training prepares students for employment as a Personal Care Aide/Caregiver with a potential for work leading to health careers. Included in the program is a hands-on lab as well as career development which provide the needed experience for future college courses and employment. Mandatory orientations for the Spring 2018 class will be held in January and February 2018 and will provide the schedule and class information. For orientation dates and program information please call 909-274-4845.

High School Referral Program

Program description and requirements:

- Students earn deficient high school credits at the Adult Basic Education Center
- Credits are transferred to their school of origin
- Students must obtain a referral form from their high school counselor
- Parents and students must attend a mandatory orientation, made by appointment ONLY, which must be completed prior to attending class

Please call (909) 274-4937 for dates of instruction and to schedule an orientation appointment.

LEARNING ASSISTANCE CENTER

Building 6, Room 101
Lower Level of the Learning Technology Center
(909) 274-4300
<http://lac.mtsac.edu>

Center Hours:

MTWTh: 7:30 a.m. - 10:30 p.m.

F: 7:30 a.m. - 4:30 p.m.

Sa: 8:00 a.m. - 6:00 p.m.

The LAC helps students succeed in college. The LAC offers courses in basic math, reading, writing, and study techniques. Services also include tutoring, a computer lab, and test monitoring for distance learning courses. Students interested in more information should call (909) 274-4300.

Registration is accepted any time the LAC is open.

Tutoring

Tutorial Services in the LAC offers tutoring for multiple subjects. Please see the section on "Supervised Tutoring" for more details.

Learning Lab

The Learning Lab is a computer lab available for all credit and non-credit students. Workshops are offered by appointment to assist students who want more instruction on word processing, E-mail, database/web research, Power Point and course related materials. 106 PCs and 49 MACs along with technical assistance are available for students. Registration for use of the lab is necessary every semester. Students are required to present a current student picture I.D. at the front desk to access the Lab. No food or drinks are allowed in the lab and students are to work on academic material only.

Skills Development

Offers individualized material in the following subjects: reading comprehension, vocabulary, spelling, elementary math, algebra review, English grammar and study techniques (note-taking, test preparation and test-taking).

Study Techniques

Improves the following skills: time management and study strategies, effective listening, note-taking, informal outlining, how to read a textbook, memory improvement principles and test-taking techniques.

Short-Term Review

Offers individualized material for students who need a short-term review of math, reading, English usage and grammar skills.

Improving Reading Comprehension

Prepares students for reading college material. Emphasizes the mastery of reading comprehension skills and vocabulary improvement.

Improving Writing Skills

Increases the mastery of basic writing skills to a level which will permit the student to complete college writing assignments.

Math Skills Review

Improves proficiency of computational skills in operations involving whole numbers, fractions, decimals, proportions and percentages.

SUPERVISED TUTORING

Building 6, Room 101
Lower Level of the Learning Technology Center
(909) 274-6605

Office Hours:

MTWTh: 9:00 a.m. - 7:00 p.m.

F: 9:00 a.m. - 1:00 p.m.

Sa: 9:00 a.m. - 4:00 p.m.

Tutorial Services provides free individual tutoring to students in English, math, and other subjects. Study groups are available for a range of courses, including foreign languages, sciences, and nursing. Additionally, Tutorial Services provides supplemental instruction in over 20 courses.

Drop-in Tutoring

Tutors in English and math are on duty during regular hours. Drop-in and appointments for writing tutoring are available. Students are encouraged to build study time around their classes — ideally with a tutor — into their daily academic schedule.

Study Groups

Sessions are designed to give students more focused, small group time with course material. Groups of two or more students are encouraged to keep regular group meetings with a tutor for a maximum of two hours per session.

Register at Tutorial Services counter. For more information, please call (909) 274-6605.

Online Tutoring

Online tutoring is available for math and science courses through the Learning Assistance Center, and for writing through the Writing Center. Please see the website for more information: <http://www.mtsac.edu/lac/onlinetutoring>

THE WRITING CENTER

Building 26B, 1561A
<http://writingcenter.mtsac.edu>
(909) 274-5325

Spring Hours:

MTWTh: 9:00 a.m. - 9:00 p.m.
 F and Su: 9:00 a.m. - 3:00 p.m.
 Closed Saturdays

The Writing Center offers free services to all students who would like help with writing. Students need to bring a current Mt. SAC ID to access services.

Tutoring

The Center provides one-on-one tutoring in writing for any course at the College; tutors who are CRLA certified and at least one experienced composition teacher are present at all times. Both walk-in and by-appointment tutoring are available.

Workshops

In addition, the Writing Center offers a variety of workshops to help students with common writing issues, such as sentence level errors, thesis statements, essay planning and organization, and documentation. These workshops are 40-75 minutes and are taught by experienced composition instructors.

DLAs (Directed Learning Activities)

Directed learning activities are interactive exercises that target specific issues in grammar or rhetoric. They involve 45-60 minutes of self-directed activity followed by a 15-20 minute tutorial. DLA appointments are also available for students to review their DLA assignments with tutors. Professors may assign DLAs, or students can choose to work on them independently.

Computer Lab

The computer lab features grammar software and DSPS stations for DSPS students. Students who are working on DLAs (Directed Learning Activities), who have a tutoring appointment, or students who are attending workshops can also use the computer lab as well as students assigned online grammar software. A tutor is also available in the lab to answer questions.

NONCREDIT CERTIFICATES OF COMPETENCY

Basic Skills

The Basic Skills Certificate of Competency provides courses and training in skills that will improve opportunities for students to obtain employment, advance in their careers or prepare for future advanced academic studies. Students will increase basic skills, i.e., reading, writing, math and computer skills, and progress in this sequence based on individual needs. Courses are offered days and evenings to accommodate work and personal schedules. For more information, please call (909) 274-4845.

Basic Career Readiness

This certificate provides courses that will improve the entry level basic skills needs for employment. Career readiness includes personal career assessment, basic interview skills, and job search techniques that students can apply to current and future employment. Students will increase basic skills in

reading comprehension, writing, math, and basic computer literacy. For more information, please call (909) 274-4845.

English as a Second Language

ESL students are placed within a sequence of courses according to their English abilities. Students progress through this sequence based on individual need before transferring into credit courses or employment. Supplemental courses in speaking, writing and vocational language will assist their progress through the sequence and may be taken along with level classes as needed.

Courses are offered all year long, including winter and summer intersession. Classes are offered days, evenings and weekends. For more information, please call (909) 274-5235.

Adult High School Diploma

The High School Program provides all courses needed to satisfy requirements for a high school diploma. Students earning a high school diploma increase future employment and educational opportunities, including college and training programs. Completion of these courses will provide the student with a high school diploma. For more information, please call (909) 274-4845.

General Education Development (GED)

The College offers a series of courses designed to assist adult learners in preparing for the GED exam. Specifically, courses are offered in math, reading, writing, science and social studies. Students progress through each academic area based on their individual need. For more information, please call (909) 274-4845.

NONCREDIT CERTIFICATES IN VOCATIONAL TRAINING

California Community College Adult Education Programs are authorized to offer short-term vocational programs with high employment potential. The demonstration of need to offer these programs within the College service area is determined by manpower needs projections from the California Occupational Information System (COTS), or surveys of employer needs in the Continuing, or state licensing mandates and/or certification.

What Are Vocational Training Certificates?

Certificates in a variety of vocational programs are available through the School of Continuing Education Division. Many of these certificate programs mirror those offered through the credit programs of the College, are favorably recognized by business and industry, and are frequently used as a requirement for professional advancement. Classes taken are non-credit, and do not generate college units toward a degree.

Not all courses are offered every term. If a course needed for certificate completion is not offered in a timely manner, the course may be taken for credit and applied to the noncredit certificate. If the course you need is NOT being offered as a noncredit course, but you see it offered in the credit section of the class schedule, please contact the Division office at (909) 274-4220 before registration begins. We will do our best to obtain a noncredit registration for you in the class.

The Continuing Education Division also offers fee-based Certificate Programs. These include:

- CPR and First Aid
- Phlebotomy Technician
- Medical Insurance Billing Specialist
- Make-up Artistry
- Water Technology

How to Finish an Occupational Certificate

In order for students to receive a Certificate of Completion, the student must do the following:

- Register and pay material fees, if required, for desired classes
- Satisfactorily complete coursework, papers and projects, take and pass mid-terms and final with the equivalent of a "C" grade as outlined by each individual course syllabus
- When all courses are completed, submit a request to the Continuing Education Division Office, building 40.

If any courses for a noncredit certificate program have been taken for college credit, students must contact the Continuing Education Division office, (909) 274-4220, for instructions.

Certificate criteria will be verified by Continuing Education Division staff. If all requirements are met, a Certificate of Completion will be prepared and delivered to the student.

Getting Help

For more information regarding occupational training certificates, please call the Division office at (909) 274-4220.

Educational Advisers are available to assist students with Career and Education Planning. Please call (909) 274-4845 to schedule an appointment.

The following noncredit certificates are offered:

Accounting:

- Bookkeeping
- Computerized
- Payroll

Agricultural Sciences:

- Floral Design
- Horse Ranch Management
- Livestock Management
- Nursery Management
- Pet Science

Business Management:

- Business Management – Level 1
- Business Management – Level 2
- Business Management – Level 3
- Human Resource Management
- International Business – Level 1
- International Business – Level 2
- Retail Management – Level 1
- Retail Management – Level 2
- Retail Management – Level 3
- Small Business Management – Level 1
- Small Business Management – Level 2
- Small Business Management – Level 3

Electronics:

- Computer and Networking Technology – Level 1
- Computer Systems Technology
- Electronic Assembly and Fabrication
- Electronic Systems Technology
- Electronic Technology
- Electronics and Computer-Engineering Technology
- Electronics Communications
- Industrial Electronics

Health Careers:

- Acute Certified Nursing
- Certified Nursing Assistant
- Home Health Aide Assistant
- In Home Support Services
- Physical Therapist Aide

Manufacturing Technology:

- Manufacturing and Electrical Systems
- MasterCAM

Office Technology:

- Administrative Assistant – Level 1
- General Office
- Office Computer Applications

Photographics:

- Photography

Welding Technology:

- Welding
- Licensed Welder
- Welding: Automotive Welding, Cutting and Modification
- Welding: Gas Tungsten ARC Welding
- Welding: Semiautomatic ARC Welding

The School of Continuing Education also prepares students for careers in:

- Acute CNA
- Certified Home Health Aide

WILDLIFE SANCTUARY TOURS

Guided tours of Mt. SAC's Wildlife Sanctuary are available with advanced notice. The tours focus on the wonders of nature, exploring water and land ecosystems, studying plant animal habitats, and observing lake, pond, swamp and stream environments. There is a 10-person minimum required for this tour. Due to the enclosed space and narrow pathways at the sanctuary, there is a 30 person maximum.

Tours are available at no cost; however, we would appreciate a donation to help offset the costs for the tour guides.

Please contact Campus Events at (909) 274-4794 to arrange for a tour. Tours are given during the fall and spring semesters only.

SHORT-TERM VOCATIONAL

ADMINISTRATION OF JUSTICE

VOC ADJ01

The Administrative Justice System

History and philosophy of the justice system, subsystems, roles, relationships and theories of crime causation and correction.

44387	T	11:30am - 2:40pm	Jefferson, P	28B-104
44388	Th	11:30am - 2:40pm	Jefferson, P	28B-104

VOC ADJ02

Principles and Procedures of the Justice System

Due process in criminal proceedings from pre-arrest through trial and appeal using statutory law and legal precedent.

44390	M	11:30am - 2:40pm	Jefferson, P	28B-104
44389	W	11:30am - 2:40pm	Jefferson, P	28B-104
44391	T	6:30pm - 9:40pm	Sweet, W	28B-204

AGRICULTURE: ORNAMENTAL HORTICULTURE

VOC AGR13

Landscape Design

Landscape design for residential and small commercial sites including the design process, drafting, graphics, site evaluation, landscaping materials, and plant usage. Field trips and off-campus assignments are required.

44459	T	5:30pm - 6:35pm	Scott, B	80-1421
	and T	6:45pm - 7:50pm	Scott, B	80-1421
	and T	8:00pm - 10:10pm	Scott, B	80-1421
		and arrange 1 hour	Scott, B	80-1421

VOC AGR32

Landscaping and Nursery Management

Operation and management of wholesale and retail nurseries. Includes site location and layout of areas; greenhouse management; soil mixes and proper use of fertilizers, insecticides, fungicides, herbicides and growth regulators; irrigation; mechanization; financing; personnel management; retail displays, advertising and customer relationships; federal, state and local laws and regulations. Field trips are required.

44461	T	5:30pm - 6:35pm	Baugh, A	80-1200
	and T	6:45pm - 7:50pm	Baugh, A	80-1200
	and T	8:00pm - 10:10pm	Baugh, A	80-1200
		and arrange 1 hour	Baugh, A	80-1200

VOC AGR53

Small Engine Repair 1

Principles and repair of small engines used in landscape, industrial and agricultural applications. Includes repair of lawnmowers, chainsaws, 2-cycle engines, 4-cycle engines, spraying equipment, all-terrain vehicles, and other related gas-powered equipment.

44462	Th	5:30pm - 7:50pm	STAFF	80-1220
	and Th	8:00pm - 10:10pm	STAFF	80-1220
		and arrange 1 hour	STAFF	

VOC AGR72

Landscape Hardscape Applications

Landscape construction pertaining to hardscape featured in the landscape. Estimation and installation of fences, walks, planters, patios, lighting, barbecues, gazebos, decks, ponds, spas, fountains, and pools. Students will gain hands-on experience in the laboratory activities.

44463	W	5:30pm - 6:35pm	Merrick, L	80-1200
	and W	6:45pm - 7:50pm	Merrick, L	80-1200
	and W	8:00pm - 10:10pm	Merrick, L	80-1200
		and arrange 1 hour	Merrick, L	80-1200

VOC AGR75

Urban Arboriculture

Care and management of ornamental trees. Includes pruning techniques, fruit tree care, bracing, cabling, and pest control. Safe practices in the use of equipment including the use of ropes, chippers, boom trucks, chain saws, and identification and evaluation of common trees. Prepares students for the tree worker and arborist certification exams.

44464	T	5:30pm - 6:35pm	Hinostroza, J	80-1401
	and T	6:45pm - 7:50pm	Hinostroza, J	80-1401
	and T	8:00pm - 10:10pm	Hinostroza, J	80-1401
		and arrange 1 hour	Hinostroza, J	80-1401

ARCHITECTURE

VOC AR121

CADD and Digital Design Media - Level I

CADD Level I (Computer Aided Design and Drafting) and computer application in architecture, engineering and related fields, including spreadsheet, CAD, and presentation application. Field trips required.

44393	MW	8:00am - 9:25am	Lenox, J	13-2265
	and MW	9:35am - 11:10am	Lenox, J	13-2265
44392	TTh	8:00am - 9:25am	Chinchilla, M	13-2225
	and TTh	9:35am - 11:10am	Chinchilla, M	13-2225

VOC AR141

Design Drawing and Communicaton

Architectural drawing techniques including graphic standards, scales, orthographic, paraline, and perspective projections. Field trips required.

44394	TTh	8:00am - 9:25am	DeJarnett, M	13-2215
	and TTh	9:35am - 11:10am	DeJarnett, M	13-2215

BUSINESS: ACCOUNTING

VOC BA07

Principles of Accounting - Financial

Financial accounting required of Business Administration and Accounting majors. Defines financial accounting and its relevance to business decision-makers, accounting concepts and techniques, analysis and recording of financial transactions, and preparation, analysis and interpretation of financial statements focusing on application of generally accepted accounting practices. Includes asset, liability, and equity valuation, revenue and expense recognition, cash flow, internal controls, ethics, and financial statement analysis. General Ledger Accounting Software program is integrated throughout and used to complete various homework assignments.

44556	MW	7:00am - 9:35am	Brown, M	79-3250
44557	TTh	7:00am - 9:35am	Little, D	79-3250
44558	MW	9:45am - 12:20pm	Truong, P	79-2230
44559	MW	9:45am - 12:20pm	Valdes, S	79-3250
44560	TTh	9:45am - 12:20pm	Domico, B	79-3250
44561	TTh	9:45am - 12:20pm	Valdes, S	79-2230
44562	MW	12:30pm - 3:05pm	Valdes, S	79-3250
44563	TTh	1:30pm - 4:00pm	Bowers, E	79-3250
44564	MW	7:00pm - 9:35pm	Quintero, H	79-2230

VOC BA11**Fundamentals of Accounting**

Accounting vocabulary and theory, equations to solve word problems, simple and compound interest, present value, consumer and business credit, mortgages, financial statements and ratios, inventory, depreciation, business taxes, investments.

44565 M 7:00pm - 10:10pm Freeland, E 78-3100

VOC BA68**Business Mathematics**

Addition, subtraction, multiplication, division, decimal, percentages, fractions, sign numbers, equations, and problem-solving.

44566 W 7:00pm - 10:10pm Freeland, E 78-3100

VOC BA70**Payroll and Tax Accounting**

On-the-job payroll accounting. Surveys the various tax procedures required by the employer and employee in filing the correct forms for Social Security, federal, and state income taxes and their reconciliation. Laws related to Worker's Compensation, State Disability Benefit Laws and Fair Employment Practices are discussed.

44567 W 7:00pm - 10:10pm Holloway, B 79-3230

VOC BA71**Personal Financial Planning**

Integrative approach to personal finance focusing on practical financial decision making as well as the social, psychological, and physiological contexts in which those decisions are made. Students will examine their relationships with money, set personal goals, and develop a plan to meet those goals. Topics include consumerism, debt, healthcare, investing, retirement, long-term care, disability, death, and taxes.

44568 T 7:00pm - 10:10pm Smith, G 78-3240

VOC BA72**Bookkeeping - Accounting**

Bookkeeping and accounting principles including the accounting cycle for service and merchandising companies, cash management, payroll and special journals. Computerized simulations and completion of an accounting project for a company.

44569 MW 7:00pm - 9:35pm St John, T 78-1130

VOC BA75**Using Microcomputers in Financial Accounting**

Accounting concepts utilizing QuickBooks, a general-ledger software program. Hands-on use of a microcomputer to process accounting transactions, prepare statements and reports, and complete accounting cycle tasks. Completion of a computerized accounting practice set will be required.

44570 M 4:30pm - 6:35pm Valdes, S 79-3270

44571 Th 5:30pm - 7:35pm Quintero, H 79-3270

VOC BA76**Microcomputers in Managerial Accounting**

Analysis of financial data and preparation of managerial accounting reports using Excel software. Development of what-if formulas to be used as an aid in decision-making. Includes manufacturing and consolidation worksheets, financial statement analysis, and statements of cash flow.

44572 M 9:45am - 11:50am Bates, B 79-3270

44573 Th 5:30pm - 7:35pm Quintero, H 79-3270

BUSINESS: MANAGEMENT**VOC BM10****Principles of Continuous Quality Improvement**

History and evolution of thought in Continuous Quality Improvement, including the theories and methods of Deming, Juran, and Crosby. Quality management process and tools for the continuous improvement of quality are presented. Relevant case studies are included.

44521 MW 11:30am - 12:55pm Freeman, C 20-5

44522 M 7:00pm - 10:10pm Freeman, C 79-3280

VOC BM20**Principles of Business**

Business and its functions, background, development, organization, and opportunities. Business terms, current trends, methods, contemporary and future problems, and current business practices.

44530 MW 8:00am - 9:25am Silva, J 79-3280

44526 MW 9:45am - 11:10am Freeman, C 79-3280

44531 TTh 9:45am - 11:10am Bartz, V 79-3290

44532 MW 11:30am - 12:55pm Martinez, R 79-3290

44529 TTh 11:30am - 12:55pm Mc Farland, T 79-3260

44535 M 7:00pm - 10:10pm Atherton, S 79-3250

44533 T 7:00pm - 10:10pm Martinez, R 79-3290

44536 W 7:00pm - 10:10pm Carrasco, G 79-3260

44534 Th 7:00pm - 10:10pm Martinez, R 79-3290

VOC BM60**Human Relations in Business**

Inter-disciplinary study of how people work and relate at the individual, group and organizational level. Topics include motivation, team work, leadership skill and how to handle organizational change.

44538 TTh 8:00am - 9:25am Simmons, S 79-3260

44537 TTh 9:45am - 11:10am Mc Farland, T 79-3260

44539 T 7:00pm - 10:10pm Dokter, D 79-3280

VOC BM61**Business Organization and Management**

Functions of management, techniques of decision making and problem solving, and methods used by managers to achieve organizational goals. Theories of management, lines of authority, functions of departments, and the importance of policies, procedures and controls.

44540 MW 1:15pm - 2:40pm Atherton, S 79-3260

44541 W 7:00pm - 10:10pm Atherton, S 79-3240

VOC BM62**Human Resource Management**

Direction of people including guidance, control supervisory problems, training, job analysis, interviewing, testing, rating and other functions involving human resources. Designed to improve the overall understanding of the relationship between the individual and the business organization.

44542 TTh 11:30am - 12:55pm Silva, J 79-3290

44543 W 7:00pm - 10:10pm Martinez, R 79-3290

VOC BM66**Small Business Management**

Organizing, starting, and operating a small business enterprise. Emphasis on entrepreneurial applications in a small business environment.

44545 TTh 8:00am - 9:25am Jagodka, R 79-3240

44546 TTh 9:45am - 11:10am Jagodka, R 79-3240

44547 Th 7:00pm - 10:10pm Qu, G 79-3240

BUSINESS: COMMUNICATIONS**VOC B025****Business Communication**

Written communications including letters and memos meeting a variety of situations in the business environment. Includes writing of good news, bad news, sales, claims, and persuasive correspondence; letters and resumes appropriate to job seeking and application; and practicing oral skills as applied to job interviews and business reports.

44549	TTh	8:00am - 9:25am	Bartz, V	77-2040
44548	M	7:00pm - 10:10pm	Martinez, R	77-2040
44551	T	7:00pm - 10:10pm	Blosser, K	77-2040
44550	Th	7:00pm - 10:10pm	Salata, K	77-2040

BUSINESS: SALES AND MARKETING**VOC BS36****Principles of Marketing**

Organization and function of system of distributing goods and services from the point of production to the consumer. Preparation of a marketing plan using product, distribution, promotional, and pricing strategies.

44552	MW	11:30am - 12:55pm	Scholz, S	79-3260
44553	TTh	11:30am - 12:55pm	Bartz, V	79-3240
44554	W	7:00pm - 10:10pm	Sandhu, S	79-3280

VOC BS50**Retail Store Management and Merchandising**

Principles and practices used in the management and merchandising of retail stores. Includes critical buying function, merchandising, promotional techniques, sit selection, layout, staffing, market positioning, and customer service.

44555	M	7:00pm - 10:10pm	Salata, K	79-2270
-------	---	------------------	-----------	---------

COMPUTER AND NETWORK TECHNOLOGY**VOC CNT50****PC Servicing**

PC and peripheral servicing techniques, preventative maintenance, hardware configurations, software configurations, software diagnostics, and the use of test equipment.

44395	M	8:00am - 11:10am	Miller, K	28B-401
	and M	11:30am - 2:40pm	Miller, K	28B-401
44396	M	6:30pm - 9:40pm	Hauchwitz, M	28B-404
	and W	6:30pm - 9:40pm	Yee, H	28B-401

MANUFACTURING AND ELECTRICAL SYSTEMS CERTIFICATE

Students will learn manufacturing theory including Lean Manufacturing and waste elimination management; components of and how to read blueprints; manufacturing and production principles including torque; basic assembly techniques; use of materials and manual and power tools; safety; electrical systems; troubleshooting electrical circuits; quality control; diagnostics investigation; fundamentals of welding processes; tools for the transportation industry and business management techniques. The course is offered in Fall and Spring.

ENGINEERING**VOC EDT16****Basic CAD and Computer Applications**

Basic CD (Computer Aided Design and Drafting) and computer application in engineering and related fields (including basic word processing, spreadsheet, CAD and presentation applications).

44422	MW	3:00pm - 4:30pm	Cusolito, A	28B-301B
	and MW	4:35pm - 6:10pm	Cusolito, A	28B-301B
44423	TTh	7:00pm - 8:30pm	Cusolito, A	28B-301A
	and TTh	8:40pm - 10:10pm	Cusolito, A	28B-301A

VOC EDT18**Engineering CAD Applications**

Intermediate CAD for engineering, explores the 2-D and 3-D environments, 3-D parametric solid modeling.

44424	MW	3:00pm - 3:50pm	Takahashi, S	28B-301A
	and MW	4:00pm - 6:10pm	Takahashi, S	28B-301A

ELECTRONICS**VOC EL11****Technical Applications in Microcomputers**

Personal computer (PC) applications used in electronics technology. Includes word processing, spreadsheets, database, computer presentation methods, and internet research specifically designed for electronics technology.

44398	T	8:00am - 10:05am	Uranga, J	28B-312
	and T	10:15am - 1:20pm	Uranga, J	28B-312
44397	MW	6:00pm - 7:10pm	Uranga, J	28B-312
	and MW	7:20pm - 8:35pm	Uranga, J	28B-312

VOC EL12**Computer Simulation and Troubleshooting**

Use of the personal computer for simulation and troubleshooting of analog and digital circuits. National Instruments Multisim software will be used for circuit analysis, value substitution, and fault diagnostics.

44399	M	5:00pm - 6:05pm	Denny, J	28B-312
	and M	6:10pm - 9:15pm	Denny, J	28B-312

VOC EL50A**Electronic Circuits (DC)**

Direct Current (DC) electrical circuits and their applications. Covers DC sources, analysis, test equipment, measurements and troubleshooting of resistive devices and other basic components. Includes Ohm's Law, Kirchhoff's Law and network theorems (Students seeking a survey course in electronics should take VOC EL10, Introduction to Mechatronics, rather than VOC EL50A or 50B.)

44400	MW	8:00am - 11:10am	Denny, J	28B-405
	and MW	11:30am - 2:40pm	Denny, J	28B-405
44401	TTh	8:00am - 11:10am	Hymer, J	28B-401
	and TTh	11:30am - 2:40pm	Hymer, J	28B-401

VOC EL50B**Electronic Circuits (AC)**

Alternating Current (AC) electrical circuits and their applications. Covers AC sources, analysis (using complex numbers), test equipment, measurements, and troubleshooting of basic circuits with capacitors, inductors, and resistors. Includes impedance, resonance, filters, and decibels.

44402	MW	8:00am - 11:10am	Denny, J	28B-405
	and MW	11:30am - 2:40pm	Denny, J	28B-405
44403	TTh	8:00am - 11:10am	Hymer, J	28B-401
	and TTh	11:30am - 2:40pm	Hymer, J	28B-401
44404	T	6:30pm - 9:40pm	Olague, J	28B-403
	and Th	6:30pm - 9:40pm	Olague, J	28B-403

ELECTRONIC SYSTEMS TECHNOLOGY CERTIFICATE: VOC EST 50, 54 & 56

Students will learn the skills required to prepare them for employment with telephone companies, satellite/cable TV providers, electrical contractors, computer networking companies and home theater/home security retailers. The course is offered in Fall and Spring.

VOC EL54B

Industrial Electronic Systems

Systems application of industrial electronics including industrial production and processes, automation, and programmable and motor controllers. Emphasis is on programmable logic controllers (PLCs)

44405 M	8:00am - 10:30am	Uranga, J	28B-412
and M	10:40am - 1:10pm	Uranga, J	28B-412

VOC EL55

Microwave Communications

Microwave components and circuits. Stresses transmission lines, Smith Charts, impedance matching, antenna characteristics, wave propagation, frequency analysis, and measurement techniques.

44418 W	8:00am - 11:10am	Hymer, J	28B-410
and W	11:30am - 2:40pm	Hymer, J	28B-410

VOC EL56

Digital Electronics

Combinational and sequential logic circuits emphasizing number systems, binary math, basic gates, Boolean algebra, Karnaugh maps, flip-flops, counters, and registers. Stresses design and troubleshooting techniques.

44419 T	8:00am - 11:10am	Harsany, S	28B-405
and T	11:30am - 2:40pm	Harsany, S	28B-405

VOC EL61

Electronic Assembly and Fabrication

Manufacturing and fabrication processes associated with the electronics industry. Printed circuit board (PCB) design from conception to completion. Emphasizes electrical schematics, bill of material (BOM), component selection, layout design, manufacturability, assembly, soldering, de-soldering, and surface-mount technology.

44420 T	5:00pm - 7:25pm	Denny, J	28B-314
and T	7:35pm - 10:10pm	Denny, J	28B-314

VOC EL74

Microcontroller Systems

Microcontroller systems and programming methods; programmable logic devices (PLDs); serial communications; conversion of signals from analog to digital formats and the converse. Industry applications, interfacing and troubleshooting.

44421 Th	8:00am - 11:10am	Christ, J	28B-403
and Th	11:30am - 2:40pm	Christ, J	28B-403

FASHION

VOC FSH10

Clothing Construction 1

Essentials of industry standard apparel construction techniques using a variety of machines and equipment. Students will be given instruction in single needle machine operation, industrial overlock operation, and garment assembly.

44719 Th	9:45am - 11:50am	Holinsworth, J	78-2185
and Th	12:00pm - 3:10pm	Holinsworth, J	78-2185
44717 T	12:30pm - 3:35pm	Davis, M	78-2185
and T	3:45pm - 5:45pm	Davis, M	78-2185
44718 MW	7:00pm - 8:25pm	Davis, M	78-2185
and MW	8:35pm - 9:25pm	Davis, M	78-2185

FLORAL DESIGN

VOC AGR26

Floral Design 2

Contemporary floral design theory emphasizing creativity, self-expression, and professional design situations.

NOTE: Semester cost of flowers and supplies is \$250. Fees must be paid at the Bursar's Office, Building 9A, prior to the first class meeting. Receipt must be presented to the instructor at the first class meeting.

44449 Th	6:00pm - 10:05pm	Tucker, R	80-1200
----------	------------------	-----------	---------

GENERAL OFFICE

VOC CS11

Computer Keyboarding

Formerly VOC CP01 Develops alpha and numeric keyboarding skills on a personal computer at a straight-copy rate of 25 to 40 gross words a minute, with a predetermined error limit. Includes keyboarding of letters, tables and manuscripts.

44260 Th	8:30am - 11:35am	STAFF	66-238
44263 W	6:30pm - 10:00pm	STAFF	66-238

VOC CSB15

Microcomputer Applications

Windows operating system and applications; simple business examples using up-to-date browser; word processing, spreadsheet, database management and presentation software; and integration of software applications.

44268 M	8:00am - 11:30am	STAFF	66-238
---------	------------------	-------	--------

GENERAL OFFICE SKILLS CERTIFICATE: VOC CSB15, VOC CSB41, BS ABE05

This is an introductory course providing instruction in Office Management Skills, Microcomputer Applications (Word, Excel, Powerpoint, Google programs) and Career Development/Work Readiness to prepare students for an entry level position. The program is offered Fall, Spring, and Summer.

44269 W	8:00am - 11:30am	STAFF	66-238
44270 T	6:30pm - 10:00pm	STAFF	66-238
44271 Th	6:30pm - 10:00pm	STAFF	66-238

INTERIOR DESIGN

VOC ID10

Intro to Interior Design

Provides a foundation for further training in careers including Interior Design, Furnishings and Maintenance; Interior Decorating; and Environmental Interior Design and Architecture.

44508 MW	9:45am - 11:50am	Ball, H	TBA
44509 T	6:30pm - 8:35pm	Woods, L	13-1230
44510 S	9:00am - 11:05am	Noonan, I	13-1230

VOC ID10L

Introduction to Interior Design Laboratory

Application of the interior design practice and the planning of total interior environments that meet individual, functional and environmental needs. Field trips may be required.

44511 S	11:30am - 2:40pm	Noonan, I	TBA
---------	------------------	-----------	-----

MANUFACTURING TECHNOLOGY

VOC MF11

Manufacturing Processes 1

Manual and computerized manufacturing, manual lathes and mills, tool nomenclature and Computerized Numerical Control (CNC) operations. Operation of CNC machines.

44426	TTh	3:15pm - 4:20pm	Bright, T	28B-301A
and	TTh	4:30pm - 5:50pm	Bright, T	28B-301A

VOC MF12

Manufacturing Processes 2

The study of manufacturing equipment and manufacturing processes. Theory and practice in milling operations, tooling setup, metallurgy, heat treatment, precision grinding and basic tool design.

44428	F	6:00pm - 6:50pm	Bright, T	28A-102K
and	F	7:00pm - 10:15pm	Bright, T	28A-102K

VOC MF38

MasterCAM 1

Use MasterCAM software to create wire-frame part geometry, add tool paths and create CNC code for CNC mills and CNC lathes.

44429	TTh	7:00pm - 8:05pm	Buechler, M	28B-301A
and	TTh	8:15pm - 9:40pm	Buechler, M	28B-301A

VOC MF85

Manual CNC Operations

Theory and practice in manually developing CNC programs. Methods of transmitting data to CNC machines and physical set-up and operations of CNC equipment.

44430	TTh	6:00pm - 9:10pm	STAFF	28A-102K
and	T	9:20pm - 10:10pm	STAFF	28A-102K

PHOTOGRAPHY

VOC PH004

Digital Cameras and Composition

Use of digital cameras, lenses, filters and exposure to compose quality photographs. Shooting assignments are given for analysis in class. Camera will be required after the second week.

44320	F 3/2/18	6:00pm - 8:05pm	Schaedel, J	13-1430
and	S 3/3/18	9:00am - 4:50pm	Schaedel, J	13-1430
and	Su 3/4/18	9:00am - 4:50pm	Schaedel, J	13-1430

VOC PH009

Digital Image Edit

Software and techniques including digital workflow practices, digital image editing, enhancing and retouching methods commonly used in photography.

44322	T	8:00am - 10:05am	Benoe, C	13-2425
and	Th	8:00am - 11:10am	Benoe, C	13-2425

VOC PH010

Basic Digital and Film Photography

Basic mechanical, optical and chemical principles of photography, including digital image systems. Laboratory experience involves problems related to camera and image output techniques.

44323	M	8:00am - 10:05am	Hartman, L	13-1455
and	W	8:00am - 11:10am	Hartman, L	13-1455
44324	T	8:00am - 10:05am	Hartman, L	13-1455
and	Th	8:00am - 11:10am	Hartman, L	13-1455
44331	F	9:00am - 11:05am	Perez, J	13-1455
and	F	11:15am - 2:25pm	Perez, J	13-1455
44326	M	11:30am - 1:35pm	Hartman, L	13-1455
and	W	11:30am - 2:40pm	Hartman, L	13-1455
44325	T	11:30am - 1:35pm	Perez, J	13-1455
and	Th	11:30am - 2:40pm	Perez, J	13-1455
44328	M	3:00pm - 5:05pm	Schenck, S	13-1455
and	W	3:00pm - 6:10pm	Schenck, S	13-1455
44327	T	3:00pm - 5:05pm	Cook, D	13-1455
and	Th	3:00pm - 6:10pm	Cook, D	13-1455
44332	M	6:30pm - 8:35pm	Mc Cready, L	13-1455
and	W	6:30pm - 9:40pm	Mc Cready, L	13-1455
44329	T	6:30pm - 8:35pm	Edwards, C	13-1455
and	Th	6:30pm - 9:40pm	Edwards, C	13-1455
44333	S	9:00am - 11:05am	Zajack, G	13-1455
and	S	11:15am - 2:25pm	Zajack, G	13-1455

VOC PH011

Advanced Professional Photography

Current professional techniques and studio lighting. Includes studio and field assignments related to problems encountered while professionally photographing people and products. Topics include medium and large format film and digital cameras, computer basics for professional photographers and studio lighting. Students must furnish a digital single lens reflex (DSLR) camera. Field trips may be required.

44336	M	6:30pm - 8:35pm	Perez, J	13-1430
and	W	6:30pm - 9:40pm	Perez, J	13-1430

VOC PH012

Photograph Alternatives

Alternative photographic processes. Instant films: lifts and transfers, specialized lighting, stain toning, emulsion coating, and scenography will be applied to produce images not considered common to making photographic prints.

44338	F	8:00am - 10:05am	Rager, G	13-1430
and	F	10:15am - 1:25pm	Rager, G	13-1430

VOC PH014

Commercial Lighting

Use of studio equipment, and studio and location lighting techniques used in all aspects of commercial photographic applications. Field trips may be required.

44339	M	8:00am - 10:05am	Swintek, S	13-1430
and	W	8:00am - 11:10am	Swintek, S	13-1430

VOC PH016

Fashion and Editorial Portrait Photography

Fashion and editorial portrait photography with studio and location lighting techniques, creative concepts, styling, and working with models.

44343	M	3:00am - 5:05pm	Loy, J	13-2425
and	W	3:00pm - 6:10pm	Loy, J	13-2425

VOC PH018

Portraiture and Wedding Photography

Professional studio and field techniques for portrait and wedding photography. Off-camera assignment or field trips may be required.

44344	T	3:00pm - 5:05pm	Felix, L	13-2425
and	Th	3:00pm - 6:10pm	Felix, L	13-2425

VOC PH01A**Laboratory Studies: Beginning Black and White Photography**

Extended black-and-white laboratory experiences to improve skills through further instruction and practice, as well as pursue more advanced projects and experiments.

44347	T	2:00pm - 5:10pm	Hartman, L	13-1430
44349	Th	3:00pm - 6:10pm	Benoe, C	13-1430
44346	T	6:30pm - 9:40pm	STAFF	13-1430

VOC PH01B**Laboratory Studies: Advanced Black and White Photography**

Extended advanced black and white laboratory experiences with medium and large format cameras to improve skills and pursue more advanced photographic printing, processing, and enlarging techniques.

44351	T	2:00pm - 5:10pm	Hartman, L	13-1430
44352	Th	3:00pm - 6:10pm	Benoe, C	13-1430
44350	T	6:30pm - 9:40pm	STAFF	13-1430

VOC PH01C**Laboratory Studies: Studio Photography**

Extended studio photography experiences to supplement those available through the regular program. Provides students the opportunity to improve skills through further instruction and practice, as well as pursue more advanced projects and experiments.

44358	T	2:00pm - 5:10pm	Hartman, L	13-1430
44361	Th	3:00pm - 6:10pm	Benoe, C	13-1430
44355	T	6:30pm - 9:40pm	STAFF	13-1430

VOC PH01D**Laboratory Studies: Computer Applications in Photography**

Extended computer laboratory experiences to supplement those available in the regular program. Provides students the opportunity to improve skills through further instruction and practice, as well as pursue more advanced projects and experiments.

44366	T	2:00pm - 5:10pm	Hartman, L	13-1430
44367	Th	3:00pm - 6:10pm	Benoe, C	13-1430
44365	T	6:30pm - 9:40pm	STAFF	13-1430

VOC PH020**Color Photography**

Use of color principles as they relate to commercial and artistic styles. This includes lighting, color theory, color management, exaggerated and unique color schemes applied color psychology principles.

44368	M	11:30am - 1:35pm	Benoe, C	13-1430
	and W	11:30am - 2:40pm	Benoe, C	13-1430

VOC PH021**Exploring Color Photography**

Use of color principles as they relate to commercial and artistic styles and innovative use of color applications. Includes lighting and unusual techniques, exaggerated and unique color schemes, light-painting, lighting effects, high dynamic range effects and oversize output.

44369	M	11:30am - 1:35pm	Benoe, C	13-1430
	and W	11:30am - 2:40pm	Benoe, C	13-1430

VOC PH024**Advanced Digital Image Editing for Photographers**

Advanced software and techniques for digital image editing, archiving, and retouching used in commercial photography.

44370	T	6:30pm - 8:35pm	Clark, H	13-2425
	and Th	6:30pm - 9:40pm	Clark, H	13-2425

VOC PH030**Commercial and Illustrative Photography**

Overview of the commercial photographic industry. Exploration of the various commercial photography specialties including studio product and people photography, lifestyle, fashion and industrial/location photography with an emphasis on the development of a personal creative style. Field trips may be required.

44371	T	8:00am - 10:05am	Perez, J	13-1430
	and Th	8:00am - 11:10am	Perez, J	13-1430

TECHNOLOGY TRAINING**VOC TCH60****Customer Relations for the Technician**

Customer relations (soft skills) for the technician including benefits for knowing and using effective customer contact tools, proper customer interactions, ethics and maintaining customer satisfaction.

44431	F	5:30pm - 10:00pm	Uranga, J	28B-404
-------	---	------------------	-----------	---------

THEATRE**VOC THR15****Play Rehearsal/Performance**

Planning, preparation and presentation of college-sponsored dramatic presentations. Emphasis on acting with some technical theater assignments. Attendance at performance is required.

44384	MTWTh	7:00pm - 10:10pm	Cummings, C	2-T130
-------	-------	------------------	-------------	--------

NOTE: CRN 44384 above holds auditions: Monday, February 26th, and Tuesday, February 27th, 2017 at 7:00 PM in 2-T130. Production: "Six Characters in Search of an Author" by Luigi Pirandello. Enrollment is contingent on a successful audition.

44385	MTWTh	7:00pm - 10:10pm	Burgos, M	2-T130
-------	-------	------------------	-----------	--------

NOTE: CRN 44385 above holds auditions: Monday, February 26th, and Tuesday, February 27th, 2017 at 7:00 PM in 2-T130. Production: "26 Pebbles" by Eric Ulloa. Enrollment is contingent on a successful audition.

WELDING**VOC WL30****Metal Sculpture**

Welding processes used in the metal sculpting industry to create three-dimensional art forms. Covers design, pre-construction analysis, and cost estimates for projects. Includes use of equipment for oxyfuel welding, gas metal arc welding (GMAW), gas tungsten arc welding (GTAW), shielded metal arc welding (SMAW), and flux-cored arc welding (FCAW). Includes demonstrations and exercises in welding as it relates to the art industry.

44432	Th	1:30pm - 2:20pm	Eisley, B	69-6911
	and Th	2:30pm - 5:45pm	Deines, C	69-6911

VOC WL40**Introduction to Welding**

Fundamentals of welding processes related to the areas of fabrication, construction, machine tool, aerospace and the transportation industries.

44438	M	8:00am - 8:50am	Tapia, R	69-6912
	and M	9:00am - 12:15pm	Tapia, R	69-6912
44433	Th	8:00am - 8:50am	Newell, A	69-6911
	and Th	9:00am - 12:15pm	Newell, A	69-6911
44437	M	1:30pm - 2:20pm	Garcia, D	69-6921
	and M	2:30pm - 5:45pm	Garcia, D	69-6921
44434	F	1:30pm - 2:20pm	Newell, A	69-6911
	and F	2:30pm - 5:45pm	Newell, A	69-6911
44435	T	6:00pm - 6:50pm	Osendorf, D	69-6911
	and T	7:00pm - 10:15pm	Osendorf, D	69-6911

VOC WL50**Oxyacetylene Welding**

Oxyacetylene fusion welding, non-fusion welding and cutting. Develops understanding of and fundamental skills in modern welding practices.

44439	W	8:00am - 8:50am	Garcia, D	69-6911
	and W	9:00am - 12:15pm	Garcia, D	69-6911
44440	M	6:00pm - 6:50pm	Garcia, D	69-6911
	and M	7:00pm - 10:15pm	Garcia, D	69-6911
44441	F	6:00pm - 6:50pm	Kuchta, J	69-6911
	and F	7:00pm - 10:15pm	Kuchta, J	69-6911

VOC WL51**Basic Electric Arc Welding**

Electric arc welding, weld symbols, standard electrode and alloy electrode selection, American Welding Society (AWS) procedure for certification.

44442	T	8:00am - 8:50am	Londo, D	69-6911
	and T	9:00am - 12:15pm	Londo, D	69-6911
44443	F	6:00pm - 6:50pm	Mulick, B	69-6911
	and F	7:00pm - 10:15pm	Mulick, B	69-6911

VOC WL53A**Welding Metallurgy**

Designed for students seeking a career in welding and welding inspection. Covers structure of matter, chemical, physical and mechanical properties of metals, principles of alloying, solid state diffusion, plastic deformation and heat treatment.

44444	W	7:00pm - 10:10pm	Kuchta, J	69-6921
-------	---	------------------	-----------	---------

VOC WL70A**Beginning Arc Welding**

Develops manipulative skills and techniques for Shielded Metal Arc (SMAW) and Flux Cored Arc (FCAW) welding processes in the flat and horizontal positions using AC and DC welding currents on carbon steel.

44447	MW	1:00pm - 1:50pm	Newell, A	69-6911
	and MW	2:00pm - 4:50pm	Newell, A	69-6911
44448	TTh	6:15pm - 7:05pm	Newell, A	69-6911
	and TTh	7:15pm - 10:05pm	Newell, A	69-6911

VOC WL70B**Intermediate Arc Welding**

Welding high alloy steel with both Shielded Metal Arc (SMAW) and Flux Core Arc (FCAW) welding processes in the vertical and overhead positions with an introduction to Gas Metal Arc (GMAW) and gas Tungsten (GTAW) welding.

44451	TTh	8:00am - 8:50am	Garcia, D	69-6911
	and TTh	9:00am - 12:05pm	Garcia, D	69-6911
44450	S	8:30am - 9:35am	Mulick, B	69-6911
	and S	9:45am - 12:05pm	Mulick, B	69-6911
	and S	1:00pm - 4:35pm	Mulick, B	69-6911

VOC WL70C**Certification for Welders**

Building construction for the advanced arc welding student. Special emphasis will be placed on welding symbols and the American Welding Society's (AWS) D1.1 and D1.3.

44453	TTh	1:00pm - 1:50pm	Garcia, D	69-6911
	and TTh	2:00pm - 4:50pm	Garcia, D	69-6911
44452	MW	5:00pm - 5:50pm	Eisley, B	69-6911
	and MW	6:00pm - 9:10pm	Eisley, B	69-6911

VOC WL80**Construction Fabrication and Welding**

Theory and practical applications of welding used in industry and construction. Designed to adapt and upgrade skills to industry standards and develop fabrication skills to supplement and augment welding skills. Includes project models such as ornamental iron gates and fences and material storage components.

44454	S	8:30am - 9:35am	Tapia, R	69-6911
	and S	9:45am - 12:05pm	Tapia, R	69-6911
	and S	1:00pm - 4:35pm	Tapia, R	69-6911

VOC WL90A**Gas Tungsten Arc Welding**

Advanced Gas Tungsten Arc Welding (GTAW) or tungsten inert gas (TIG) of steel, aluminum, corrosion resisting steel (CRES), and exotic metals. All position welds with many surfaces and transitions.

44455	MW	6:15pm - 7:05pm	Khattar, F	69-6911
	and MW	7:15pm - 10:20pm	Khattar, F	69-6911

VOC WL90B**Semi Automatic Arc Welding Process**

Semiautomatic Welding Processes including Gas Metal Arc Welding (GMAW), Flux Cored Arc Welding (FCAW), Submerged Arc Welding (SAW) with solid and tubular wires with and without gas shielding. All position welds with many varying thicknesses will be covered.

44456	MW	6:15pm - 7:05pm	Mendoza, M	69-6911
	and MW	7:15pm - 10:20pm	Mendoza, M	69-6911

DISABLED STUDENT PROGRAMS AND SERVICES**DSPS ESL26****Language Enhancement for Deaf Students in ASL and ESL**

Language enhancement for Deaf or hard-of-hearing students. Intermediate skills in written ESL and ASL.

44303	T	9:45am - 12:55pm	Mahler, R	9E-1060
	and Th	9:45am - 12:55pm	Mahler, R	9E-1060

DSPS LRND1**Clinical Speech Instruction**

Designed for Mt. SAC students with acquired brain injury. Specialized instruction to improve speech (articulator movement, motor planning) language (expressive, receptive) and cognition (attention, memory, reasoning) needed to achieve academic and vocational goals. Note: Students must make an appointment with the instructor, have acquired the injury after the age of 12, and have completed any services through the public school system in order to be eligible to register for this class.

44307	F	11:00am - 12:05pm	Walker, C	9E-1060
-------	---	-------------------	-----------	---------

DSPS LRND2**High Tech Center: Assistive Technology and Academic Strategies**

Technology and academic strategies to assist students in accessing information and completing credit class assignments. Students should be registered with DSPS and enrolled in at least 3 academic units.

44308	MTWTh	8:00am - 12:05pm	Ponce, H	9E-1105
	and MTWTh	12:10pm - 6:05pm	Ponce, H	9E-1105
	and F	8:00am - 1:05pm	Ponce, H	9E-1105

DSPS LRND3

Acquired Brain Injury Intervention

Designed for students who have been accepted into the Acquired Brain Injury Program at Mt. SAC. Specialized instruction and the use of computer software to improve cognitive skills (attention, memory, reasoning, etc) needed for academic and vocational goals. Note: Students must see a brain injury specialist in Disabled Student Programs and Services (DS-PandS), have acquired their injury after the age of 12, and have finished with any services through the public school system in order to be eligible to register in this class.

44309	MTWTh	8:00am - 12:05pm	Ponce, H	9E-1190
	and MTWTh	12:10pm - 6:05pm	Ponce, H	9E-1190
	and F	8:00am - 1:05pm	Ponce, H	9E-1190

ENGLISH AS A SECOND LANGUAGE (ESL)

**Building 66 (Language Center), Lower Level
Mt. SAC Campus
(909) 274-5235, eslreg@mtsac.edu
www.mtsac.edu/esl/**

Our goal is to help you strengthen your English communication skills, assist you with your future college and career success, and support you as a member of the community.

Spring Session: February 27 – June 17, 2018.

Steps to Enrollment:

1. **Come in person** to ESL, Building 66/Language Center, lower level. The placement test is offered every Thursday.
2. **Assessment and Placement** — Take the ESL placement test to determine the correct course level for your English ability.
3. **Registration** — We will register you immediately after you complete the placement test. If classes are full, we will add you to a waiting list and contact you when space is available.

Note: New student testing is offered every Thursday.

Thursday testing times are:

Morning Classes: 8:30 and 11:00 a.m.

Evening Classes: 4:30 and 7:00 p.m.

Check-in begins 30 minutes before each test. A photo ID is required to take the placement test. Please allow 2 hours for testing, orientation, and registration. There will be no testing on holidays.

For registration, call (909) 274-5235 or email eslreg@mtsac.edu.

One of the following levels will be recommended:

Pre-level:

For students with no experience in English. Learn to recognize and use common English words.

Levels 1 & 2:

Develop basic spoken and written English for everyday needs. Speak and write about personal interests and life experiences.

Levels 3 & 4:

Build communication skills and monitor the language learning process. Increase conversational fluency, vocabulary development and grammar accuracy.

Levels 5 & 6:

Focus language learning toward personal academic and vocational goals. Integrate language skills with lifelong learning strategies necessary for successful transition into college credit programs and/or a vocation.

Other Class Options:

Speaking Skills P1, A, B, & C:

Listening and speaking including vocabulary development, idioms, pronunciation and every day conversation practice. For literacy (P1), beginning (A), intermediate (B) and advanced (C) students.

Writing Skills A, B, & C:

Reading and writing including basic vocabulary, spelling, writing sentences, paragraphs and simple essays using familiar topics and American customs. For literacy (P1), beginning (A), intermediate (B) and advanced (C) students.

TOEFL Preparation: Preparation for the TOEFL Test (computer version) for advanced students.

Citizenship Preparation: Intensive preparation and practice for the U.S. Citizenship interview.

VESL Career Paths

This program is designed to help advanced ESL students (Levels 5 & 6) to transition from noncredit ESL to credit or vocational certificate programs. It combines advanced ESL classes with computer classes and education/career planning classes. Students must successfully complete the two-semester program in order to receive a certificate. Contact the VESL Specialist at (909) 274-5236, for more information.

Note: VESL classes are offered only in the Fall and Spring semesters for new students.

Language Learning Center (LLC)

The Language Learning Center (LLC) offers a wide variety of language learning software, videos, DVDs and recordings to improve listening, speaking and pronunciation skills for American Language, Arabic, Chinese, English as a Second Language, French, German, Italian, Japanese, Sign Language and Spanish.

Open enrollment throughout the semester. Open to anyone. Register at the LLC front desk. ESL students may also register in ESL registration office (Language Center, Building 66).

Location: Language Learning Center (Building 77, room 1005).

Note: LLC is closed during the first and last week of spring semester

Dates: February 27 - June 9, 2018

Times: MTWTh: 8:00 a.m. - 9:00 p.m.

F: 8:00 a.m. - 2:00 p.m.

Sa: 9:00 a.m. - 2:00 p.m.

Get more information on our website

at <http://www.mtsac.edu/llc> or call (909) 274-4580.

HEALTH CAREERS

**Health Careers Resource Center
Mt. SAC Campus, Building 67B, Room 250
(909) 274-4788**

The HCRC provides a state-of-the-art learning lab environment to:

- Develop new health related skills/knowledge
- Update prior or current knowledge
- Participate in simulated clinical activities

The center is open to credit and noncredit health career students.

HEALTH CAREERS: SHORT TERM VOCATIONAL TRAINING CERTIFICATES, BLDG. 40, ROOM 101

For additional information and how to register for these courses, please call (909) 274-4220.

Acute Certified Nursing Assistant Certificate VOC HTH04

The Acute Care Nursing Assistant class is an additional 96 hours beyond the CNA program. This includes 32 hours of theory and 64 hours of clinical. Students who took the CNA program and passed the State Exam are eligible for the program. The Acute Care Nursing Assistant is a CNA who works in various departments of acute care hospitals. The program is offered in Spring and Fall.

Certified Nursing Assistant (CNA) VOC HTH01, VOC HTH05

The School of Continuing Education (SCE) Certified Nursing Assistant (CNA) Program at Mt. San Antonio College provides the participant with the knowledge and skills to be eligible to take the state certification exam and works as an entry level healthcare provider with individuals, in a long-term care facility. Course content may increase chances for successful admission to an LVN or RN program.

Home Health Aide Certification VOC HHA

Eligible students are those who have completed the CNA program and passed the State exam. The course provides an additional 40 hours of training, 20 hours each in theory and clinical. The program is offered in Spring and Fall.

In Home Support Services VOC IHSS, BS ABE05

This training prepares the student to become a Personal Care Aide/Caregiver in 6-7 weeks. The program is designed to prepare students to assist elderly, disabled and ill individuals living at home. Students will learn to recognize physical, emotional, and developmental characteristics of individuals. Training is offered Fall, Winter, Spring and Summer. To register for a mandatory Orientation, email abeinfo@mtsac.edu.

Physical Therapist Aide VOC HTH 12, VOC PT81

This course will provide students with a basic understanding of working in a physical therapy setting with patients who need rehabilitation. The course includes medical terminology used in the profession. The program is offered Fall, Spring and Summer.

Health Careers Resource Center Available Services

- RN assistance in clinical skills practice and performance evaluation
- Medical and hospital equipment/supplies/ manikins/ simulators/ training aides for hands-on demonstrations and application of basic, intermediate and advanced skills
- Health Skills Performance Update/Evaluation
- Clinical simulations for Med-Surg, Psych, OB, Peds, Perioperative, Critical Care.
- METI/CAE Adult, Child, and Infant Human Patient Simulators. Gaumard Birthing Simulator

Required Registration for the HCRC

Registration is open the entire semester to Mt. SAC students enrolled in credit or noncredit health careers programs. You may register by visiting the HCRC for a registration card and course registration number. Upon completion of the registration process, you must present a current Mt. SAC Student ID card and sign in on each visit in order to check in and use the facilities.

Student Identification

Students must also bring their current MT. SAC PHOTO I.D. card to the center on each visit. I.D. cards are available for \$10 at Bldg. 9A.

Hours of Operation

February 26 - June 17, 2018

Days: MTWThF

Times: 6:00 a.m. - 7:00 p.m. (M)
8:00 a.m. - 7:00 p.m. (T)
8:00 a.m. - 6:00 p.m. (W)
6:00 a.m. - 6:00 p.m. (Th)
9:00 a.m. - 3:00 p.m. (F)

R.N. is available: 11:00 a.m. - 6:00 p.m. Monday, Wednesday, Thursday, 12:00 p.m. - 7:00 p.m. Tuesday, and 11:00 a.m. - 3:00 p.m. Friday

NURSING ASSISTANT PROGRAM (CNA) ORIENTATION FOR SUMMER INTERCESSION 2018 CLASS

A detailed schedule of exact dates and times of classes will be provided at the orientation meeting. Mandatory orientation for Spring and Summer 2018 will be held during the Spring 2018 semester. For more information, call (909) 274-5757.

VOC HTH05**Health Careers Skills Lab (HCRC)**

Health occupational training and experience using instructional equipment and simulators for health occupation competencies.

44476 Associates Degree Nursing Program
 44477 Bachelor Degree Nursing Program
 44478 Continuing Education
 44479 CNA / Acute CNA
 44480 Medical Services - EMT, Paramedic, PA Prep
 44481 Mental Health / Psych Tech Program
 44482 Respiratory Therapy
 44483 Radiology
 44484 Phlebotomy
 44485 Healthcare Interpreting
 44486 Home Health Aide
 44487 In Home Support

EDUCATION FOR OLDER ADULTS

Classes begin the week of February 26 and end June 17, unless stated otherwise.

Mt. San Antonio College Continuing Education Division offers classes for older adults on campus and at various senior and community centers, and residential facilities throughout the area. Courses in this section are designed and developed to meet the educational needs of older adults. However, persons age 18 or over may enroll.

For more information, call (909) 274-4192.

COMPUTER SKILLS

NOTE: Computer Registration Dates and Locations: (All Computer classes including digital photography and Internet) Each person must register for himself/herself. Students may not register for anyone else. Students may register for only one class. Registration for new computer students is first come first served. Note: the student is permitted to take the computer class only two (2) times consecutively

- Walnut Senior Center – 1/29/18 from 10:00-11:00 a.m. (Monday)
- La Verne Community Center – 1/30/18 from 10:00-10:30 a.m. (Tuesday)
- San Dimas Community Center – 1/31/18 from 10:00-11:00 a.m. (Wednesday)
- West Covina Senior Center – 2/1/18 from 10:00-10:30 a.m. (Thursday)
- Shadow Oak Park – 2/2/18 from 10:00-10:30 a.m. (Friday)
- Palomares Senior Center – First day of class
- Steinmetz Senior Center – First day of class
- Pathfinder Park – First day of class

VOC BCDP**Basic Computing - Desktop Publishing**

Basic desktop publishing to create and produce professional-looking publications.

44417	F	11:30am - 2:35pm	Kretschmar, J	66-228
44416	Th	12:55pm - 4:00pm	Jones, V	PATH

VOC BCPP1**PowerPoint Basics 1**

Basic use of PowerPoint to create slide presentations.

44427	F	11:30am - 2:35pm	Kretschmar, J	66-228
44425	Th	12:55pm - 4:00pm	Jones, V	PATH

VOC BCPP2**PowerPoint Basics 2**

Create PowerPoint presentations using text and object animation, video, audio, and hyperlinks.

44458	F	11:30am - 2:35pm	Kretschmar, J	66-228
44436	Th	12:55pm - 4:00pm	Jones, V	PATH

VOC CPBC1**Basic Computing - Level 1**

Introduction to the personal computer, including terminology and basic computer operations in a Windows environment.

44493	Th	8:55am - 12:00pm	Kretschmar, J	WCSCC
44494	T	9:00am - 12:05pm	Mc Farlin-Stagg, Z	LV
44496	T	11:40am - 2:45pm	Rzonca, S	WALT
44495	T	12:25pm - 3:30pm	Miranda, B	SD

VOC CPBC2**Basic Computing - Level 2**

Create documents in applications such as Microsoft Word; includes basic computer maintenance and problem-solving techniques.

44498	M	8:25am - 11:30am	Jones, V	WSSC
44497	W	8:25am - 12:00pm	Bloom, D	WCSCC
44499	M	8:55am - 12:00pm	Miranda, B	PSC
44500	W	8:55am - 12:00pm	Miranda, B	SD
44501	Th	11:40am - 2:45pm	Rzonca, S	WALT

VOC CPBC3**Basic Computing - Level 3**

Software application skills including creative projects which introduce computer graphics.

44502	M	8:25am - 12:00pm	Bloom, D	WCSCC
44505	Th	8:25am - 11:30am	Rzonca, S	WALT
44503	T	8:55am - 12:00pm	Miranda, B	PSC
44506	Th	8:55am - 12:00pm	Smith, H	SOP
44507	T	9:00am - 11:50am	Tom, A	SD
44504	F	9:00am - 12:05pm	Purper, K	LV

VOC CPBE1**Basic Excel - Level 1**

Introduction to Excel, including terminology, and working with data in a spreadsheet application.

44513	T	8:25am - 11:30am	Rzonca, S	WALT
44512	M	11:30am - 2:35pm	Ortiz, C	66-169
44514	T	12:55pm - 4:00pm	Smith, H	SOP

VOC CPBE2**Basic Excel 2**

Basic functions in Excel including formulas, sorting, filtering data, and formatting tables.

44518	T	8:25am - 11:30am	Rzonca, S	WALT
44517	M	11:30am - 2:35pm	Ortiz, C	66-169
44519	T	12:55pm - 4:00pm	Smith, H	SOP

VOC CPBE3**Basic Excel 3**

Basic Excel including storing, manipulating and analyzing data in spreadsheets and displaying data graphically using charts.

44523	T	8:25am - 11:30am	Rzonca, S	WALT
44520	M	11:30am - 2:35pm	Ortiz, C	66-169
44525	T	12:55pm - 4:00pm	Smith, H	SOP

VOC CPCC**Creative Computing**

Creative skills in utilizing graphic designs for projects such as business cards, letterhead, labels, flyers, posters, greeting cards, and computer-generated fabric designs.

44527	F	8:55am - 12:00pm	Miranda, B	SD
44528	F	9:00am - 11:50am	Tom, A	WCSCC

VOC CPDI**Digital Photography for the Beginner**

Digital camera operations, image management, composition, and use of graphics software.

44578	MW	8:30am - 9:45am	Purper, K	WALT
44579	T	8:55am - 12:00pm	Smith, H	SOP
44577	Th	8:55am - 12:00pm	Purper, K	SD
44580	T	12:30pm - 3:20pm	Tom, A	WCSCC

VOC CPNET

Internet Research - an Introduction

Fundamental Internet functions including terminology, email, search engines and research tools.

44584	W	8:30am - 11:35am	Ortiz, C	WSSC
44583	T	8:55am - 12:00pm	Kretschmar, J	WCSCC
44585	W	8:55am - 12:00pm	Smith, H	SOP
44588	M	9:00am - 11:50am	Tom, A	SD
44587	W	9:00am - 11:50am	Tom, A	PSC
44586	Th	9:00am - 11:50am	Tom, A	LV
44582	F	9:00am - 12:05pm	Jones, V	WALT
44581	T	12:55pm - 4:00pm	Jones, V	PATH

DECORATIVE/HOME AND FINE ARTS

VOC HBB1

Starting a Home-Based Business

Starting a home-based business to become self-employed. Includes basic marketing, finance and management skills.

44640	M	8:55am - 12:00pm	Tucker, R	LV
-------	---	------------------	-----------	----

VOC HBB2

Managing and Growing Your Home-Based Business

Managing day-to-day business activities to increase revenue and profitability to grow a home-based business.

44642	M	8:55am - 12:00pm	Tucker, R	LV
-------	---	------------------	-----------	----

OAD FNA03

Oil Painting

Principles of drawing, design, color and composition for oil painting emphasizing creative skill development for the older adult population.

44621	Th	8:00am - 11:55am	Conte, K	WALT
-------	----	------------------	----------	------

NOTE: Walnut Senior Center: General Registration Date for the Following Classes: 1/29/18 from 10:00-11:00 a.m. (Monday) Note this is for classes held at Walnut Senior Center only. Oil Painting, Home Gardening, Beginning Decorative Art Production for Retail Sales, Healthy Aging Principles of Slow Movement, and all Computer Classes including Digital Photography. Each person must register for himself/herself. Students may not register for anyone else. Registration is first come first served at Walnut Senior Center.

44623	T	9:00am - 11:50am	Conte, K	LV
-------	---	------------------	----------	----

OAD FNA04

Watercolor Painting

Principles of watercolor painting for the older adult population. Emphasis will be on creative expression to develop primary skills for watercolor as they relate to composition and technique.

44622	W	8:45am - 11:35am	Conte, K	CCHCH
44630	M	9:00am - 11:50am	Conte, K	MAS
44629	T	9:00am - 11:50am	Conte, K	LV
44632	F	10:00am - 12:50pm	Conte, K	WCSCC
44634	W	12:55pm - 4:00pm	Smith, H	PATH
44633	Th	12:55pm - 4:00pm	Smith, H	DBC
44635	F	12:55pm - 4:00pm	Tucker, R	PSC
44631	T	1:00pm - 3:50pm	Conte, K	SD

OAD FNA32

Drawing-Beginning Through Advanced

Perceptual and technical skills of drawing. Includes dry and fluid media for the older adult population. Focus on single objects, still life and landscape.

44639	Th	8:55am - 12:00pm	Tucker, R	LV
44636	T	12:30pm - 3:35pm	Tucker, R	DBC
44638	M	1:00pm - 4:05pm	Tucker, R	HERI

HOME-BASED BUSINESS

VOC AGR-G

Home Gardening

Organic gardening, plants, fruit orchards, and traditional gardening for the older adult population, including design, propagation methods, pruning, fertilizing, and pest control.

44410	M	10:00am - 11:50am	Williams, S	PATH
44408	W	10:00am - 11:50am	Williams, S	DBC
44415	Th	10:00am - 11:50am	Williams, S	WCSCC
44407	F	11:40am - 1:30pm	Williams, S	40-140
44413	M	1:00pm - 2:50pm	Williams, S	TBA
44409	T	1:00pm - 2:50pm	Williams, S	LV
44412	W	1:00pm - 2:50pm	Williams, S	SD
44414	Th	1:00pm - 2:50pm	Williams, S	WALT

NOTE: Walnut Senior Center: General Registration Date for the Following Classes: 1/29/18 from 10:00-11:00 a.m. (Monday) Note this is for classes held at Walnut Senior Center only. Oil Painting, Home Gardening, Beginning Decorative Art Production for Retail Sales, Healthy Aging Principles of Slow Movement, and all Computer Classes including Digital Photography. Each person must register for himself/herself. Students may not register for anyone else. Registration is first come first served at Walnut Senior Center.

VOC ESD02

Production of Boutique Crafts for Retail Sales

Design and production of boutique crafts for the older adult population. Includes marketing, pricing, cost analysis, and emerging technology.

44603	T	9:25am - 12:30pm	Beightol, D	SD
44602	M	12:55pm - 4:00pm	Beightol, D	IRWN

VOC ESD03

Lettering Styles and Advertising Calligraphy

Styles of calligraphy as they are used in art, media, and advertising for the older adult population. Includes size, placement, styles, and emerging technology.

44604	W	12:30pm - 2:20pm	Rafter, J	WCSCC
-------	---	------------------	-----------	-------

VOC ESD07

Handcrafted Needlework for Retail Sales

Needlework technique including knitting, crocheting, embroidery, needlepoint for plastic canvas, and emerging technology to construct finished products for sale.

44605	Th	8:25am - 11:30am	Beightol, D	TBA
44606	Th	8:55am - 12:00pm	Henry, P	DBC

VOC ESD08

Jewelry Production and Design for Retail Sales

Design and construct wire-worked jewelry using beads and stones with various methods of wire wrapping, coiling, hammering, and emerging technology.

44607	Th	8:55am - 12:00pm	Paphatsarang, B	RIOVER
44608	F	8:55am - 12:00pm	Paphatsarang, B	SD

NOTE: San Dimas Senior/Community Center: • Jewelry – 1/26/18 at 9:00 am. (Friday) Registration cards will be handed out. 30 completed registration cards will be randomly drawn for class. Each person must be present during the registration process and may only register for him or herself. Students may not register for another student at this time.

44609	F	12:55pm - 4:00pm	Paphatsarang, B	WALT
-------	---	------------------	-----------------	------

NOTE: Walnut Senior Center: • Jewelry – 1/26/18 at 1:00 pm. (Friday) Registration cards will be handed out. 30 completed registration cards will be randomly drawn for class. Each person must be present during the registration process and may only register for him or herself. Students may not register for another student at this time.

VOC ESD09

Sewing and Design

Basic sewing techniques for the older adult population, including basic tailoring, pattern reading, cutting, and style design to construct professional looking garments.

44615	W	8:55am - 12:00pm	Stringfellow, S	RIOVER
44612	M	9:00am - 12:05pm	Stringfellow, S	LV
44610	Th	9:00am - 12:05pm	Stringfellow, S	DBC
44613	M	12:25pm - 3:30pm	Stringfellow, S	LV
44614	W	12:25pm - 3:30pm	Stringfellow, S	RIOVER
44611	Th	12:25pm - 3:30pm	Stringfellow, S	DBC
44616	M	5:25pm - 8:30pm	Stringfellow, S	SD

VOC ESD10

Beginning Decorative Art Production for Retail Sales

Introduction to decorative painting and associated mediums for the older adult population, including painting on a variety of surfaces using tole art brush strokes used in folk art, stenciling and other design applications and emerging technology.

44617	Th	1:30pm - 4:00pm	Conte, K	WCSCC
-------	----	-----------------	----------	-------

VOC ESD11

Intermediate Decorative Art Production for Retail Sales

Intermediate tole art brush strokes on a variety of surfaces using acrylic paints, associated mediums, and emerging technology to create finished products for the older adult population.

44619	Th	1:00pm - 4:05pm	Beightol, D	SD
44618	M	5:55pm - 9:00pm	Beightol, D	LV

VOC ESD15

Jewelry and Lapidary Production Design

Jewelry making, stone cutting, polishing, and lapidary work, using emerging technology.

44589	S	8:55am - 12:00pm	Velarde, M	28B-410
-------	---	------------------	------------	---------

HEALTH

OAD BHTH1

Brain Health 1

Critical thinking and cognitive skills through understanding key structures and functions of the brain. Particular focus on auditory processing.

44488	MWF	10:00am - 11:50am	Caranci, D	PATH
44489	MWF	10:00am - 10:50am	Tamburro, M	WALT

OAD BHTH2

Brain Health 2

Age-related cognitive decline and preventative measures to strengthen and improve brain function. Particular focus on visual processing.

44491	MWF	12:30pm - 2:20pm	Friedman, K	SD
44492	MWF	12:30pm - 2:20pm	Trimble, J	PSC

OAD MOX01

Healthy Aging

Healthy aging, including diet, nutrition, disease prevention, and application of physical fitness principles to maintain health while aging.

NOTES: Walnut Senior Center: • Healthy Aging Registration – 2/5/18 at 8:45 a.m. (Monday) Registration cards will be handed out. 70 completed registration cards will be randomly drawn for each class. Each person must be present during the registration process and may only register for him or herself. Students may not register for another student at this time. Students may register for only one Healthy Aging Class.

Diamond Bar Center: • Healthy Aging – 2/7/18 at 9:00 am. (Wednesday) Registration cards will be handed out. 30 completed registration cards will be randomly drawn for each class. Each person must be present during the registration process and may only register for him or herself. Students may not register for another student at this time. Students may register for only one Healthy Aging Class.

Pathfinder Park Community Center: • Healthy Aging – 2/8/18 at 11:30 am. (Thursday) Registration cards will be handed out. 70 completed registration cards will be randomly drawn for each class. Each person must be present during the registration process and may only register for him or herself. Students may not register for another student at this time.

44663	F	7:25am - 8:30am	Jones, V	HERI
44656	MW	7:30am - 8:35am	Hunnicut, L	HERI
44651	MWF	8:00am - 8:50am	Cena, A	DBC
44677	MWF	8:00am - 8:50am	Tamburro, M	WALT
44685	MWF	8:00am - 8:50am	Valentin, N	SOP
44670	TTh	8:00am - 9:20am	Rohrenbacher, J	LV
44675	TTh	8:00am - 8:50am	Tamburro, M	PLUM
44683	T	8:45am - 9:35am	Valentin, N	COV-AT
44648	F	8:45am - 9:50am	Baker, N	BRDG
44662	MTWTh	8:55am - 10:00am	James, D	RAN
44660	MW	9:00am - 9:50am	Hunnicut, L	WCSCC
44652	MWF	9:00am - 9:50am	Cena, A	DBC
44673	MWF	9:00am - 9:50am	Suarez, M	VILA
44678	MWF	9:00am - 9:50am	Tamburro, M	WALT
44649	TTh	9:00am - 10:05am	Bresciani, A	VILA
44665	TTh	9:00am - 10:05am	Jones, V	TBA
44686	TTh	9:00am - 9:50am	Velarde, M	BRDG
44669	W	9:00am - 9:50am	Overoye, S	COUN
44667	F	9:00am - 9:50am	Ledezma, E	WCSCC
44687	F	9:00am - 9:50am	Velarde, M	RAN
44664	W	9:25am - 10:30am	Jones, V	SD
44680	M	9:30am - 10:20am	Trimble, J	SD
44684	F	9:30am - 10:20am	Valentin, N	SD
44661	MW	10:00am - 11:50am	Hunnicut, L	WCSCC
44653	MWF	10:00am - 10:50am	Cena, A	DBC
44658	TTh	10:00am - 10:50am	Hunnicut, L	PATH
44668	F	10:00am - 10:50am	Ledezma, E	WCSCC
44681	F	10:00am - 10:50am	Trimble, J	SDMS
44650	W	10:25am - 12:00pm	Bresciani, A	WALT
44682	M	10:30am - 11:20am	Trimble, J	WPK
44688	TTh	10:30am - 11:20am	Velarde, M	RGNT
44689	F	10:30am - 11:20am	Velarde, M	WPK
44666	W	10:40am - 11:45am	Jones, V	WPK
44676	MWF	11:00am - 11:50am	Tamburro, M	PSC
44659	TTh	11:00am - 11:50am	Hunnicut, L	PATH
44654	W	1:00pm - 1:50pm	Cena, A	ESGVJC
44672	Th	1:00pm - 1:50pm	Suarez, M	IRWN
44655	MF	1:25pm - 2:30pm	Cena, A	MSAG
44679	S	9:00am - 9:50am	Tan, J	COUN
44671	M	10:30am - 11:20am	Suarez, M	COV-AT
	and S	9:00am - 9:50am	Suarez, M	COV-AT

LOCATION CODES FOR OLDER ADULT PROGRAM

BRDG Bridgecreek Retirement Center	IRC Irwindale Recreation Center	SDMS San Dimas Retirement Center
CMRNPk Cameron Park Community Center	IRWN Irwindale Senior Citizens Center	SD San Dimas Senior/Community Center
CCHCH Casa Colina	LV La Verne Community Center	SDSR San Dimas Recreation Center
COUN Country View Retirement Home	MAS The Masonic Home	SOP Shadow Oak Park
COV-AT Atria - Covina	MSAG Mt. San Antonio Gardens	PLUM Stanley Plummer Building
DBC Diamond Bar Center	PSC Palomares Senior Center	VILA Villa Colima
EMSD Emeritus of San Dimas	PATH Pathfinder Park Community Center	WALT Walnut Senior Center
ESEALS Easter Seals	RAN Atria - Rancho Park Adult Community	WPK Washington Park
ESGVJC E. San Gabriel Val. Japanese Community Center	RGNT Regent Senior Living	WCSCC West Covina Senior Citizens Center
HERI Heritage Park Community Center	RIOVER Rio Verde Academy	WPCC Westmont Park Community Center
HILL Hillcrest Homes		WSSC William Steinmetz Senior Center

OAD MOX02

Healthy Aging - Principles of Slow Movement

Healthy aging, including diet, nutrition, disease prevention, and application of Tai Chi principles to maintain health while aging for the older adult population.

44691 MW	9:00am - 9:50am	Rafter, J	IRWN
44690 Th	9:00am - 10:50am	Rafter, J	DBC

NOTE: Diamond Bar Center: • Healthy Aging Principles of Slow Movement – 2/8/18 at 10:00 am. (Thursday) Registration cards will be handed out. 30 completed registration cards will be randomly drawn. Each person must be present during the registration process and may only register for him or herself. Students may not register for another student at this time. Students may register for only one Healthy Aging Principles of Slow Movement class.

44694 F	9:00am - 10:50am	Rafter, J	PLUM
44692 MW	10:00am - 10:50am	Rafter, J	IRWN
44696 M	1:00pm - 2:50pm	Rafter, J	WCSCC
44693 Th	1:00pm - 2:50pm	Rafter, J	LV
44695 T	2:00pm - 3:50pm	Rafter, J	WALT

NOTE: Walnut Senior Center: General Registration Date for the Following Classes: 1/29/18 from 10:00-11:00 a.m. (Monday) Note this is for classes held at Walnut Senior Center only. Oil Painting, Home Gardening, Beginning Decorative Art Production for Retail Sales, Healthy Aging Principles of Slow Movement, and all Computer Classes including Digital Photography. Each person must register for himself/herself. Students may not register for anyone else. Registration is first come first served at Walnut Senior Center.

OAD MOX04

Healthy Aging - Principles of Posture and Flexibility

Healthy aging, including diet, nutrition, disease prevention, and application of Yoga principles to maintaining health while aging for the older adult population.

44697 TTh	7:30am - 8:35am	Bresciani, A	HERI
44699 MWF	9:00am - 9:50am	Klein, G	PATH

NOTE: Pathfinder Park Community Center: • Healthy Aging – Principles of Posture and Flexibility – 2/9/18 at 9:00 am. (Friday) Registration cards will be handed out. 70 completed registration cards will be randomly drawn for class. Each person must be present during the registration process and may only register for him or herself. Students may not register for another student at this time.

44703 T	9:00am - 9:50am	Tamburro, M	SD
44704 Th	9:00am - 10:20am	Tamburro, M	SD
44705 Th	10:00am - 11:20am	Trimble, J	TBA
44707 T	10:15am - 11:05am	Trimble, J	WCSCC
44702 T	11:00am - 11:50am	Tamburro, M	PSC
44708 F	11:00am - 11:50am	Valentin, N	IRWN
44700 MWF	1:00pm - 1:50pm	Klein, G	SOP
44701 M	3:30pm - 5:00pm	Klein, G	WALT
44706 T	8:30am - 10:00am	Trimble, J	WALT

NOTE: Walnut Senior Center: • Healthy Aging Principles of Posture and Flexibility – 2/6/18 at 8:30 am. (Tuesday Jill Trimble) Registration cards will be handed out. 70 completed registration cards will be randomly drawn for each class. Each person must be present during the registration process and may only register for him or herself. Students may not register for another student at this time. Students may register for only one Healthy Aging Class.

44698 Th	4:30pm - 6:35pm	Klein, G	DBC
----------	-----------------	----------	-----

OAD MOX06

Healthy Aging - Principles of Aquatic Resistance

Healthy aging, including diet, nutrition, disease prevention, and application of aquatic resistance principles to maintaining health while aging for the older adult population.

44709 MTWThF	8:45am - 9:35am	Friedman, K	SDSR
44710 MTWThF	9:45am - 10:35am	Friedman, K	SDSR

LOCATION CODES FOR OLDER ADULT PROGRAM

BRDG Bridgecreek Retirement Center	IRC Irwindale Recreation Center	SDMS San Dimas Retirement Center
CMRNP Cameron Park Community Center	IRWN Irwindale Senior Citizens Center	SD San Dimas Senior/Community Center
CCHCH Casa Colina	LV La Verne Community Center	SDSR San Dimas Recreation Center
COUN Country View Retirement Home	MAS The Masonic Home	SOP Shadow Oak Park
COV-AT Atria – Covina	MSAG Mt. San Antonio Gardens	PLUM Stanley Plummer Building
DBC Diamond Bar Center	PSC Palomares Senior Center	VILA Villa Colima
EMSD Emeritus of San Dimas	PATH Pathfinder Park Community Center	WALT Walnut Senior Center
ESEALS Easter Seals	RAN Atria – Rancho Park Adult Community	WPK Washington Park
ESGVJC E. San Gabriel Val. Japanese Community Center	RGNT Regent Senior Living	WCSCC West Covina Senior Citizens Center
HERI Heritage Park Community Center	RIOVER Rio Verde Academy	WPCC Westmont Park Community Center
HILL Hillcrest Homes		WSSC William Steinmetz Senior Center

OAD MOX11

Healthy Aging: Fall Prevention, Balance and Mobility

Risks and fears associated with falling for older adults. Includes setting realistic goals, minimizing environmental risks, and balance exercises.

44713 MF 10:15am - 11:05am Klein, G WALT

NOTE: Walnut Senior Center: • Fall Prevention Balance and Mobility registration – 2/9/18 at 10:15 a.m. (Friday) Registration cards will be handed out. 70 completed registration cards will be randomly drawn for each class. Each person must be present during the registration process and may only register for him or herself. Students may not register for another student at this time. Students may register for only one Healthy Aging Class.

44711 Th 11:00am - 12:05pm James, D PSC
44716 Th 11:30am - 12:20pm Trimble, J TBA
44712 TTh 1:00pm - 1:50pm Klein, G SOP
44715 TTh 1:30pm - 2:20pm Trimble, J LV
44714 T 1:30pm - 2:20pm Suarez, M IRWN

OAD ELL04

Lifelong Learning for Older Adults

Improve or maintain mental fitness of older adults through educational activities promoting critical thinking and cognitive skills.

NOTE: Please refer to the college website for more detailed information on course offerings.

DSPS IAEP

Interacting with Emergency Personnel and Authorities

Prepares students with disabilities to interact with emergency personnel including law enforcement. Overview of the criminal justice system and reporting victimization.

44643 M 8:45am - 11:35am Cardona, Y CCHCH
44645 M 8:45am - 11:35am Lee, Z CCHCH
44644 M 8:55am - 12:00pm Espinoza Rodriguez, L RIOVER
44646 M 8:55am - 12:00pm Ramirez Catalan, B LV
44647 T 8:55am - 12:00pm Ramirez Catalan, B WPCC

LIFELONG LEARNING

DSPS ELL01

Lifelong Learning for the Special Needs Population

Educational activities for special needs students emphasizing physical, cognitive, social, and emotional skill development.

44594 TTh 8:45am - 11:35am Cena, A CCHCH
44597 TThF 8:45am - 11:45am Lee, Z CCHCH
44590 F 8:45am - 11:35am Cardona, Y CCHCH
44595 TWThF 8:55am - 12:00pm Espinoza Rodriguez, L RIOVER
44599 WF 8:55am - 12:00pm Ramirez Catalan, B LV
44601 Th 8:55am - 12:00pm Ramirez Catalan, B WPCC
44591 Th 10:30am - 11:55am Cardona, Y PLUM
44598 MTF 1:00pm - 1:50pm Lee, Z CCHCH
44592 Th 1:00pm - 1:50pm Cena, A CCHCH

Locations of Off-Campus Classes

Atria Covina

825 W. San Bernardino Rd.
Covina, CA 91722
Phone: (626) 967-9621

Atria Rancho Park

801 Cypress Way
San Dimas, CA 91773
Phone: (909) 592-9662

Bridgescreek Retirement Center

3601 Holt Ave.
West Covina, CA 91791
Phone: (626) 332-1135

Cameron Park Community Center

1305 E. Cameron Avenue
West Covina, CA 91791
Phone: (626) 919-6966

Casa Colina Hospital and Centers for Healthcare,

255 East Bonita Avenue,
Pomona, California
Phone: (909) 596-7733 X 4413

Country View Retirement

824 Cameron Ave.
West Covina, CA 91790
Phone: (626) 962-3511

Diamond Bar Center

1600 S. Grand Ave.
Diamond Bar, CA 91765
Personal Line: (909) 839-7068
Phone: (909) 839-7070

East San Gabriel Valley Japanese Community Center

1203 W Puente Avenue
West Covina, CA 91790
Phone: (626) 960-2566

Brookdale of San Dimas

1740 S. San Dimas Ave.
San Dimas, CA 91773
Phone: (909) 544-4869

Ganesha Park Pool

1575 N. White Avenue
Pomona, CA 91768
Phone: (909) 620-2329

Heritage Park Community Center

2900 Brea Canyon Rd.
Diamond Bar, CA 91765
Phone: (909) 396-5699

Hillcrest Homes

2705 Mountain View Dr
La Verne, CA 91750
Phone: (909) 392-4358

Irwindale Recreation Center

16053 Calle de Paseo
Irwindale, CA 91706
Phone: (626) 430-2227
Front desk: (626) 430-2224

Irwindale Senior Citizens Center

16116 Arrow Hwy.
Irwindale, CA 91706
Personal Line: (626) 430-2286
Phone: (626) 430-2284

Joslyn Senior Citizen's Center

Valleydale Park
815 N. Barranca
Covina, CA 91723
Phone: (626) 384-5380
(626) 858-7271

La Verne Community Center

3680 D Street
La Verne, CA 91750
Phone: (909) 596-8776
Romero: (909) 596-8724

The Masonic Home

1650 Old Badillo St.
Covina, CA 91724
Front Desk (626) 251-2200

Mt. San Antonio Gardens

900 E. Harrison Ave.
Pomona, CA 91767
Phone: (909) 624-5061

Palomares Senior Center

499 East Arrow Highway
Pomona, CA 91767
Phone: (909) 620-2324

Pathfinder Park Community Center

18150 Pathfinder Rd.
Rowland Heights, CA 91748
Phone: (562) 691-1624

Regent Assisted Living

150 S. Grand Ave.
West Covina, CA 91791
Phone: (626) 332-3344

Renacimiento Community Center

2383 Chanslor St.
Pomona, CA 91766

Rio Verde Academy

2226 E. Rio Verde Drive
West Covina, CA 91791
Phone: (909) 274-4220

San Dimas Retirement Center

834 W. Arrow Hwy.
San Dimas, CA 91773
Phone: (909) 599-4512

San Dimas Senior/Community Center

201 E. Bonita Ave.
San Dimas, CA 91773
Phone: (909) 394-6293

San Dimas Recreation Center

990 W. Covina Blvd.
San Dimas, CA 91773
Phone: (909) 592-1430

Shadow Oak Park Community Center

2121 Shadow Oak Drive.
West Covina, CA 91792
Phone: (626) 965-0328

Stanley Plummer Building

245 E. Bonita Ave.
San Dimas, CA 91773
Phone: (909) 394-6290

Villa Colima

19850 Colima
Walnut, CA 91789
Phone: (909) 595-5030

Walnut Senior Center

21215 La Puente Rd.
Walnut, CA 91789
Phone: (909) 598-6200

Washington Park

865 E. Grand Avenue
Pomona, CA 91766
Phone: (909) 620-2305

West Covina Senior Citizens Center

2501 E. Cortez St.
West Covina, CA 91791
Phone: (626) 939-8864
Front desk (626) 331-5366

Westmont Park Community Center

1808 West 9th Street
Pomona, CA 91766
Phone: (909) 620-2329

William Steinmetz Senior Center

1545 South Stimson Avenue
Hacienda Heights, CA 91745
Phone: (626) 934-7041

Continuing Education Program Index

A		I	
Administration of Justice	194	In-Home Support Services Caregiver Training	202
Adult Basic Education Center	190	Industrial Electronics	197
Adult Basic Skills Lab	190	Interior Design	197
Arc Welding	200	Internet Research (Education for Older Adults).....	204
ASVAB Preparation.....	190	J	
B		Jewelry Production & Design	
Bookkeeping Accounting	195	for Retail Sales (Education for Adults).....	204
Boutique Crafts for Retail Sales		Justice, Administration of	194
(Education for Older Adults).....	204	Justice System, Principles of	194
Business Accounting.....	194	L	
Business Communication	196	Language Learning Center (LLC).....	
Business Management.....	195	Learning Assistance Center & Lab	
Business Mathematics	195	Lifelong Learning (Education for Adults).....	
Business Organization and Management.....	195	M	
C		MFG Processes 1 & 2	
Campus Map	210-211	Manufacturing Technology	
Certificates in Occupational Training.....	193	MasterCAM (Advanced).....	
CNA Orientation	202	Manuel CNC Operation.....	
Citizenship (U.S.)	201	N	
Clinical Speech Instruction (DSPandS).....	200	Needlework for Retail Sales (Education for Adults).....	
Computer and Networking Technology.....	196	O	
Computing		Off-Campus Class Locations	
(Levels 1,2,3 for Education for Older Adults).....	203-204	Oil Painting (Education for Adults)	
D		P	
Decorative Art Production for		Parking Information	
Retail Sales (Education for Older Adults)	205	PC Servicing.....	
Digital Electronics	197	Photography	
Digital Photography for the Beginner		Photography, Advanced Professional	
(Education for Older Adults).....	203	R	
Disabled Students Programs & Services.....	200	Registration Process.....	
Drawing (Beginning – Advanced) (Older Adults).....	204	S	
E		SAT Preparation	
Education for Older Adults	203	Study Techniques	
Electronic Assembly/Fabrication	197	Short-Term Vocational Programs.....	
Electronics	196	T	
Electronics, (AC) (DC).....	196	TOEFL.....	
English as a Second Language (ESL).....	201	Technical Applications in Microcomputers.....	
F		Technology Training	
Farm Tours (Ad).....	189	Tutoring	
G		V	
GED Exam Preparation/Testing.....	190	Vocational English as a Second Language (VESL).....	
H		W	
Health Care/Careers	202-203	Watercolor Painting (Education for Adults).....	
Health Careers Resource Center	202	Welders Certification	
Healthy Aging (Education for Older Adults)	205	Welding.....	
Healthy Aging (Principles of Aquatic Resistance)	206	WIN Program (Tutoring for Athletes).....	
Healthy Aging (Principles of Posture and Flexibility).....	206	Writing Skills.....	
Healthy Aging (Principles of Slow Movement).....	206	Writing Center	
High School Diploma Program for Adults.....	190		
High Tech Center Tutorial/ Assistance (DSPandS)	200		
Home Gardening (Education for Older Adults).....	204		

Legend for Campus Map

Location Building Number + (Grid)

A

Academic Senate	4 (F,2)
Accessible Technology Center (DSPS)	9E (D,2)
ACES	9E (D,2)
Adult Basic Education Center	30 (B,4)
Admissions & Records	9B (D,2)
Administration	4 (F,2)
Agricultural Sciences	80 (C,5)
Animation Drawing Lab	13 (D,3)
Art Center	1A/B/C (D,1)
Art Computer Graphics Lab	13 (D,3)
Art Gallery/Classrooms	1B/C (D,1)
Arts Division Office	12 (D,3)
ARISE (Asian American Pacific Islander Program)	16B (E,3)
ASPIRE	9D (D,2)
Assessment	9B (D,2)
Athletics Modular	44 (G,4)
Auxiliary Services	9A (D,2)

B

Biological Services 7 (F,3), 11 (E,2), 60 (E,3) & 61 (E,2)	
Bookstore (SacBookRac) Photo ID	9A (D,2)
Box Office	2T (E,1)
Bursar's Office/Permits	4 (F,2)
Business Division Office	17 (E,3)
Business Faculty Offices	18A, B (E,3)
Bridge/Learning Communities	9E (D,2)

C

Campus Events	6 (E,2)
Campus Police (Public Safety)	23 (F,5)
Career & Transfer Services	9B (D,2)
Center for Deaf and Hard of Hearing Services (DHH)	9A (D,2)
Center of Excellence	21D (E,3)
Central Plant	29 (D,4)
Central Plant Office	29B (D,4)
Chemistry Department	7 (F,3)
Child Development Administration	70 (C,4)
Child Development Classes	73 (C,4)
Child Development Complex	70-73 (C,4)
Child Development Faculty Offices	73 (C,4)
Clarke Theater	2T (E,1)
Communication Department	26D (E,3)
School of Continuing Education Division Office	40 (C,5)
Counseling Department	9B (D,2)

D

Dance Studio	2T (E,1)
Design Technology	13 (D,3)
Disabled Student Programs & Services	9B (D,2)
Document Storage/Facilities Planning	46A (F,5)
DREAM	16C (E,3)

E

English Department Office	26D (E,3)
EOPS/CARE/CalWORKs	9B (D,2)
Emergency Operations Center/ Facilities Construction Offices	46 (F,5)
ESL Classrooms	31A & B, 32, 35-36 (B,4) & 66 (D,4)
Exercise Science/Wellness Center	27A (E,4)
Express Stop (Food & Supplies)	16A (E,3)

F

Facilities, Planning + Management / Maintenance + Operations	47 (F/G,5)
Farm (Agriculture/Horticulture/VetTech)	
48th District Agricultural Association	F10 (D,5)
Agricultural Sciences	80 (C,5)
Equine Unit	F6A-B-C (D,6)
Equipment Barn	F3 (C,5)
Equipment Technology	F7 (D,5)

Farm Offices	F2A (C,5)
Horticulture Storage	F2B (C,5)
Horticulture Unit	F1 (B,5)
Irrigation & Landscape Construction	F2C (C,5)
Livestock Pavilion	F9 (C,5)
Small Animal Care Unit	F5B (C,6)
Swine Unit	F4A & F4B (B/C,6)
Vivarium	F5A (C,6)
Fashion	13 (D,3)
Fedderson Recital Hall	2M (E,1)
Field House	50G (F,6)
Financial Aid	9B (D,2)
Fiscal Services	4 (F,2)
Foreign Languages	66 (D,4)
Forensics	26D (E,3)
Foundation Office	12 (D,3)
Founders Hall	10 (E,2)

G

Grants	4 (F,2)
Gym	3 (E,2)

H

Health Careers Center	67A & B (D,4)
Health Careers Resource Center	67B (D,4)
Heating/Air Conditioning	69 (E,4)
High School Outreach	9B (D,2)
High School Referral/ Adult Diploma Programs	32, 33 & 38A-B (B,4)
History/Geography/ Political Science	26D (E,3)
Honors Program	26A (D,3)
Hospitality & Restaurant Management	19B (E,3)
Human Resources	4 (F,2)
Humanities & Social Sciences Division Office	66 (D,4)
Humanities/Social Sciences	26A, B & D (D/E,3)

I

Information Technology	23 & 23A (F,5)
Instruction Office	4 (F,2)
Interior Design	13 (D,3)

J

Journalism	26D (E,3)
------------	-----------

K

KSAK Radio	6 (E,2)
Kinesiology, Athletics & Dance	45 (F,4)
Kinesiology, Athletics & Dance Division Office	45 (F,4)

L

Language Center	66 (D,4)
Library / Learning Technology Center	6 (E,2)
Library & Learning Resources Division Office 6	(E,2)
Locker Rooms	27C (E,4)

M

Mail Center	4 (F,2)
Maintenance & Operations/Facilities Planning & Management	47 (F/G,5)
Marketing & Communication	4 (F,2)
Math & Science	61 (E,2)
Math Tutoring	61 (E,2)
Media Services	6 (E,2)
Mental Health Faculty Offices	67A (D,4)
Mountie Café (Food)	8 (D,2)
Mountie Grill - WOW (Food)	19C (E,3)
Music/Dance/Theater Classes	2M & 2T (E,1)

N

Natural Sciences Division Office	61 (E,2)
Natural Sciences Complex 7	(F,3), 11 (E,2), 60 (E,3) & 61 (E,2)
Nutrition	19B (E,3)

O

Older Adult Programs	36 (B,4)
----------------------	----------

P

Parking Office (Violations)	23 (F,5)
Payroll & Purchasing	4 (F,2)
Performing Arts Center	2M & 2T (E,1)
Photographics	13 (D,3)
Planetarium	26C (D,3)
Pool	27P (E,4)
President's Office/Board Room	10 (E,2)
Printing Services	4 (F,2)
Professional & Organizational Development	6 (E,2)
Prime Stop (Food & Supplies)	61 (E,2)
Public Affairs & Media Relations	4 (F,2)
Public Safety	23 (F,5)

R

REACH	9B (D,2)
Receiving/Transportation	48 (G,5)
Regional Health Occupations Resource Center (RHORC)	35 (B,4)
Research & Institutional Effectiveness	4 (F,2)
Risk Management	4 (F,2)

S

School of Continuing Education Division Office	40 (C,5)
Science Laboratories	60 (E,3)
Science - North	11 (E,2)
Science - South	7 (F,2/3)
Sherman Park	F1A (C,4)
Short Stop (Food & Supplies)	67A (D,4)
Starbucks	8 (D,2)
Student Health	67B (D,4)
Student Health (Satellite Office)	9E (D,2)
Student Life Center	9C (D/E,2)
Student Services Center	9B (D,2)
Student Services Annex	9D (D,2)
Student Success Center	9E (D,2)
Studio Theater	2T (E,1)

T

Teacher Preparation Institute	26A (D,3)
Technology Center	28A/B (E,3/4)
Technology & Health Division Office	28A (E,3)
Technical Education Resource Ctr (TERC)	18C (E,3)
Technical Services	6 (E,2)
Telecommunications	23 (F,5)
Tutorial Services/ Supervised Tutoring (LAC)	6 (E,2)
TV Production/Broadcasting	6 (E,2)

U

Upward Bound	9B (D,2)
--------------	----------

V

Veterans Resource Center	9E (D,2)
Vocational Technical Ed. Act (VTEA)	40 (C/D,5)

W

Welding/Air Conditioning	69 (E,4)
Wellness Center	27A (E,3/4)
WIN (Student Athlete Tutorial Center)	45 (F/G,4)
Writing Center	26B (D,3)

Mt. San Antonio College

1100 N. Grand Ave. Walnut, CA 91789

Phone: (909) 274-7500 | Campus Police: (909) 274-4555 | Text-A-Tip: (909) 610-9139

Interactive Campus Map: www.mtsac.edu/maps



Updated: 2017-05-08

EMERGENCY BLUE PHONE (909) 274-4555	STUDENT PARKING LOT	EMPLOYEE PARKING LOT	DAY USE PARKING LOT	DAY USE PERMIT DISPENSER	SHORT-TERM TIMED PARKING	METERED PARKING	INFORMATION KIOSK	PUBLIC TRANSIT STOP	ACCESSIBLE PARKING	ACCESSIBLE VAN SERVICE	SMOKING ZONE	SECURITY ESCORT Mon. - Thurs. 6:30 pm - 10:15 pm

PATHWAYS

Finding your way *is easier* than you *think!*

PATHWAYS offers classes to help **streamline your coursework** to reach your **goals quicker.**

↪ **English Pathways** offers cohorts from ENGL 68 through ENGL 1C. Some cohorts are faster paced than others.

↪ **Math Pathways** offers cohorts starting in LERN 48 through MATH 130. Most cohorts are fast paced to allow students to finish their courses quicker.

↪ **Career Focused Courses (Guided Pathways)** offers English and Math courses developed for content interests from 8 career clusters.

- Arts and Design
- Aviation, Electronics, and Manufacturing
- Business and Information Technology
- Health, Wellness, and Public Service
- Humanities and Communication
- Plants and Animals
- Sciences
- Teaching and Education

- ◆ In-Class tutoring is available in most classes
- ◆ No application needed to take a Pathways class

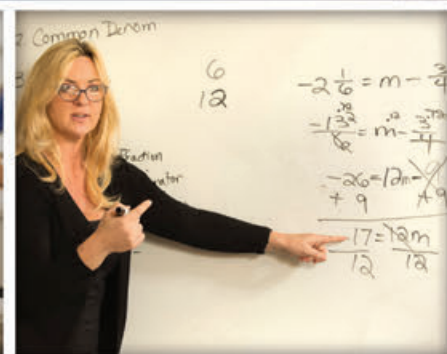

For more information about Pathways, visit: www.mtsac.edu/pathways or e-mail: pathways@mtsac.edu or call: (909) 274-5703

