



Converse Consultants

Geotechnical Engineering, Environmental & Groundwater Science, Inspection & Testing Services

**GEOTECHNICAL STUDY REPORT
Proposed Lot R Tennis and Parking Structure
Mt. San Antonio College
1100 North Grand Avenue
Walnut, California**

Converse Project No. 17-31-247-01

Prepared For:

Mt. San Antonio College
Facilities Planning & Management
1100 North Grand Avenue, Building 23
Walnut, California 91789

Prepared By:

Converse Consultants
717 South Myrtle Avenue
Monrovia, California 91016

December 1, 2017



Converse Consultants

Geotechnical Engineering, Environmental & Groundwater Science, Inspection & Testing Services

December 1, 2017

Mr. Gary Gidcumb
Mt. San Antonio College
Facilities Planning & Management
1100 North Grand Avenue, Building 23
Walnut, California 91789

Subject: **GEOTECHNICAL STUDY REPORT**
Proposed Lot R Tennis and Parking Structure
Mt. San Antonio College
1100 North Grand Avenue
Walnut, Los Angeles County, California
Converse Project No. 17-31-247-01

Dear Mr. Gidcumb:

Converse Consultants (Converse) has prepared this geotechnical study report to present the findings, conclusions and recommendations of our geologic and geotechnical study for the Proposed Lot R Tennis and Parking Structure Project located at Student Parking Lot R at Mt. San Antonio College (Mt. SAC) in Walnut, California. In accordance with California Education Code, Sections 17212 and 81033, this report was prepared consistent with the current edition of California Building Code, Title 24, Chapter 16A and Chapter 18A; California Administrative Code, Part 1, Title 24, CCR, Section 4-317 (e) and CGS Note 48-Checklist for the Review of Engineering Geology and Seismology Reports for California Public Schools, Hospitals and Essential Services Buildings, for design and for the Division of the State Architect (DSA) submittal purposes. Converse evaluated the nature and engineering properties of the subsurface soils and sedimentary bedrock to provide recommendations for site earthwork, foundation design, grading, and construction for the proposed development. Our services were performed in accordance with our proposal dated August 10, 2017.

We appreciate the opportunity to be of continued service to Mt. San Antonio College. If you should have any questions, please do not hesitate to contact us at (626) 930-1200.

Sincerely,

CONVERSE CONSULTANTS

Siva K. Sivathasan, PhD, PE, GE, DGE, QSD, F. ASCE
Senior Vice President / Principal Engineer

Dist: 5/Addressee

PROFESSIONAL CERTIFICATION

This report for the Proposed Lot R Tennis and Parking Structure Project at Student Parking Lot R located within the campus of Mt. San Antonio College in the City of Walnut, Los Angeles County, California, has been prepared by the staff of Converse under the professional supervision of the individuals whose seals and signatures appear hereon.

The findings, recommendations, specifications or professional opinions contained in this report were prepared in accordance with generally accepted professional engineering and engineering geologic principles and practice in this area of Southern California. There is no warranty, either expressed or implied.

In the event that changes to the project and property occur, or additional, relevant information about the property is brought to our attention, the conclusions contained in this report may not be valid unless these changes and additional relevant information are reviewed, and the recommendations of this report are modified or verified in writing.



Parameswaran Ariram, EIT
Senior Staff Engineer



Mark B. Schluter, PG, CEG, CHG
Senior Engineering Geologist



Siva K. Sivathasan, PhD, PE, GE, DGE, QSD, F. ASCE
Senior Vice President / Principal Engineer



EXECUTIVE SUMMARY

The following is a summary of our geotechnical investigation, conclusions and recommendations, as presented in the body of this report. Please refer to the appropriate sections of the report for complete conclusions and recommendations. In the event of a conflict between this summary and the report, or an omission in the summary, the report shall prevail.

- The proposed project consists of a large 2-level parking structure to be constructed on existing Student Parking Lot R. The Lot R Tennis and Parking Structure will be located between the new Fieldhouse and Bonita Drive, and is part of the Athletics Complex East (ACE) project currently under construction. The parking structure footprint measures up to 650 feet long in a north/south direction and 200 feet to 480 feet wide in an east/west direction and has a Level 1 footprint of approximately 199,920 square feet. The parking structure consists of a two (2) level structure consisting of one parking level at grade with one (1) supported level providing approximately 698 total parking spaces. Level 1 will have a finish surface elevation of approximately 731 feet and Level 2 will have a finish surface elevation of approximately 743 feet. Two (2) vehicular entry/exits will serve the ground level directly off Bonita Drive. Parking on the upper level will be accessed by a separate drive with entry/exit at the upper grade level. The parking structure will be partially built into the existing ground on the north side of the structure with the remaining sides open. The ground floor level of the parking structure will be founded on shallow spread and column foundations.

The top deck of the parking structure will support a variety of functions. One portion of the top deck will be isolated from the rest of the deck and used for nine (9) tennis courts with lighting. The deck separation is intended to isolate the tennis courts from any vibrations that may occur in the parking structure. Fire truck access loop and heavy media truck traffic is anticipated for the top deck level.

- Eleven (11) exploratory borings (BH-1 through BH-11) were drilled within the project site from August 18 to August 24, 2017. The borings were advanced using a truck-mounted drill rig with an 8-inch diameter hollow-stem auger to depths ranging from 30 to 80 feet below the existing ground surface (bgs).
- Seventeen (17) exploratory Cone Penetration Test (CPT-1 through CPT-17) soundings were advanced to depths of 25 to 75 feet below the existing ground surface within the project site on September 6 and 7, 2017. CPT Nos. CPT-1, CPT-2, CPT-5, CPT-7, and CPT-17 encountered very dense/stiff soils and dense/stiff sedimentary bedrock conditions, and were stopped short of their planned depths.

- There are no known active faults projecting toward or extending across the proposed site. The project site is not located within a currently designated State of California Earthquake Fault Zone (formerly Alquist-Priolo Special Studies Zones) for surface fault rupture.
- The western and southern portions of the site are underlain by alluvial soil deposits that are located within a mapped Seismic Hazard Zone for liquefaction. The results of liquefaction analyses indicate the project site is susceptible to liquefaction. The estimated potential liquefaction-induced settlement ranges from 0.43 to 2.58 inches with potential differential settlement ranging from 0.22 to 1.29 inches. The project structural engineer should consider the effects of seismically-induced settlement in the foundation design.
- Local zones of groundwater and groundwater seepage were encountered during subsurface exploration in the alluvium and sedimentary bedrock in Borings BH-3, BH-4, BH-5, BH-6, BH-7, BH-8, BH-9 and BH-11. The groundwater was encountered during drilling at depths ranging from approximately 20 feet bgs in boring BH-6 to approximately 60 feet bgs in boring BH-3. The groundwater levels encountered ranged between approximate elevations 696 feet and 713 feet. Groundwater and groundwater seepage should be anticipated during deep excavations.
- Variable thicknesses of undocumented fill soils were encountered in the borings. The undocumented fill soils are not considered suitable for slab or foundation support.
- Over-excavation and re-compaction of the undocumented fill soils, upper alluvium and top portion of the sedimentary bedrock subgrade is recommended for site grading to provide support for the proposed parking structure. Areas underlain by sedimentary bedrock (Tpss) should be over-excavated and recompacted to provide a uniform 5-foot-thick layer of compacted fill beneath the building foundations and floor slab and provide a minimum 2-foot thick layer of lime-treated soil or non-expansive, granular compacted fill soils beneath the floor slab to mitigate the low to medium expansive sedimentary bedrock materials (interbedded siltstone and claystone).

Over-excavation and re-compaction for areas underlain by alluvial soils (Qal) and the edge of the sedimentary bedrock (Tpss) along the west and south sides of the parking structure is recommended to extend approximately 10 feet below plan grade surface, a minimum of 10-feet beyond the edge of the parking structure foundations, and a minimum of 15-feet of overlap over the edge of the sedimentary bedrock (Tpss). A geofabric reinforcement layer is recommended on the compacted bottom of the 10-foot depth of over-excavation to reduce differential

settlements between the underlying alluvium and shallow sedimentary bedrock materials.

- Shallow spread and continuous footings founded on compacted fill are considered suitable for structure support provided the recommendations in this report are incorporated into the project plans and specifications, and are followed during site construction.
- Based on the proposed plan, over-excavation and re-compaction of the undocumented fills, upper alluvial soils and sedimentary bedrock is required for the building pad to achieve the planned finished grades.
- Different earth materials should be anticipated at excavation bottoms for the planned floor levels. In order to provide a relative uniform bearing material below shallow foundations, over-excavation and re-compaction below the bottom of foundations and slab-on-grades is recommended. We recommend the shallow foundations should be supported on a minimum 5-foot-thick layer of compacted fill over sedimentary bedrock materials (Tpss) and a minimum 10-foot thick layer of compacted fill over undisturbed native alluvial soils (Qal).
- On-site clayey soils with an expansion index exceeding 20 should not be re-used for compaction within 2 feet below the proposed foundations. Soils containing organic materials should not be used as structural fill. The extent of removal should be determined by the geotechnical representative based on soil observations made during grading.
- Site soils have “negligible” concentrations of water soluble sulfates.
- In general, the soluble sulfate concentration, pH and chloride content are not in the corrosive range. However, the minimum saturated resistivity is in the corrosive range to ferrous metal. Protections of underground metal pipe should be considered. Since the soluble sulfate concentrations tested for this project are less than 2,000 ppm in the soil, mitigation measures to protect concrete in contact with the soils are not anticipated.
- The earth materials at the site should be excavatable with conventional heavy-duty earth moving and trenching equipment. The on-site materials may contain gravels up to 3 inches in maximum dimension. Larger gravels, cobbles and boulders may exist at the site. Localized areas of harder, cemented and resistant bedrock units and layers (pebble conglomerates, sandstone layers, siliceous layers, cemented layers, etc.) may be encountered during excavation and grading and should be anticipated. Bedrock hardness may increase with depth within the interbedded siltstone, claystone and sandstone layers (Tpss) and pebble conglomerate (Tpcg)

where encountered. Earthwork and grading should be performed with suitable grading equipment for hard, cemented and gravelly materials.

Results of our investigation indicate that the site is suitable from a geotechnical standpoint for the proposed development, provided that the recommendations contained in this report are incorporated into the design and construction of the project

TABLE OF CONTENTS

1.0 INTRODUCTION.....	1
2.0 SITE AND PROJECT DESCRIPTION.....	2
2.1 SITE DESCRIPTION	2
2.2 PROJECT DESCRIPTION	2
3.0 SCOPE OF WORK	3
3.1 SITE RECONNAISSANCE	3
3.2 SUBSURFACE EXPLORATION	3
3.3 LABORATORY TESTING	4
3.4 ENGINEERING ANALYSES AND REPORT	4
4.0 GEOLOGIC CONDITIONS.....	5
4.1 REGIONAL GEOLOGY	5
4.2 SUBSURFACE PROFILE OF SUBJECT SITE	5
4.3 GROUNDWATER	7
4.4 SUBSURFACE VARIATIONS	8
5.0 FAULTING AND SEISMIC HAZARDS.....	9
5.1 SEISMIC CHARACTERISTICS OF NEARBY FAULTS	9
5.2 SEISMIC HISTORY.....	11
5.3 SURFACE FAULT RUPTURE	12
5.4 LIQUEFACTION AND SEISMICALLY-INDUCED SETTLEMENT	12
5.5 LATERAL SPREADING	12
5.6 SEISMICALLY-INDUCED SLOPE INSTABILITY	13
5.7 EARTHQUAKE-INDUCED FLOODING	13
5.8 TSUNAMI AND SEICHES.....	13
5.9 VOLCANIC ERUPTION HAZARD	13
6.0 SEISMIC ANALYSIS	14
6.1 CBC SEISMIC DESIGN PARAMETERS	14
6.2 SITE-SPECIFIC RESPONSE SPECTRA	14
7.0 GEOTECHNICAL EVALUATIONS AND CONCLUSIONS.....	18
8.0 EARTHWORK AND SITE GRADING RECOMMENDATIONS.....	21
8.1 GENERAL EVALUATION	21
8.2 OVER-EXCAVATION/REMOVAL	22
8.3 STRUCTURAL FILL	24
8.4 EXCAVATABILITY	25
8.5 EXPANSIVE SOIL	25
8.6 SHRINKAGE AND SUBSIDENCE.....	26
8.7 SUBGRADE PREPARATION	26
9.0 DESIGN RECOMMENDATIONS	28
9.1 SHALLOW FOUNDATIONS	28
9.2 MODULUS OF SUBGRADE REACTION.....	29

9.3	LATERAL EARTH PRESSURE.....	29
9.4	SLABS-ON-GRADE.....	30
9.5	SOIL CORROSIVITY EVALUATION	30
9.6	FLEXIBLE PAVEMENT	31
9.7	RIGID PAVEMENT	32
9.8	SITE DRAINAGE.....	33
10.0	CONSTRUCTION RECOMMENDATIONS.....	34
10.1	GENERAL.....	34
10.2	TEMPORARY EXCAVATIONS.....	34
10.3	SHORING DESIGN.....	35
11.0	PLAN REVIEW AND CONSTRUCTION INSPECTION SERVICES	38
12.0	CLOSURE.....	39
13.0	REFERENCES.....	40

TABLES

		Page No.
Table No. 1,	Summary of Regional Faults.....	10
Table No. 2,	CBC Seismic Design Parameters	14
Table No. 3,	2016 CBC Mapped Acceleration Parameters.....	15
Table No. 4,	Probabilistic Response Spectrum Data.....	15
Table No. 5,	Site-Specific Response Spectrum Data	16
Table No. 6,	Site-Specific Seismic Design Parameters	17
Table No. 7,	Lateral Earth Pressures for Retaining Wall Design	29
Table No. 8,	Soil Corrosivity Test Results	30
Table No. 9,	Flexible Pavement Structural Sections.....	31
Table No. 10,	Rigid Pavement Structural Sections.....	32
Table No. 11,	Slope Ratios for Temporary Excavation	34

DRAWINGS

		Following Page No.
Drawing No. 1,	Site Location Map.....	1
Drawing No. 2,	Site Plan and Approximate Location of CPTs and Borings.....	1
Drawing No. 3,	Regional Geologic Map	5
Drawing No. 4,	Geologic Cross Section A-A'.....	7
Drawing No. 5,	Geologic Cross Section B-B'.....	7
Drawing No. 6,	Geologic Cross Section C-C'	7
Drawing No. 7,	Geologic Cross Section D-D'	7
Drawing No. 8,	Southern California Regional Fault Map	9
Drawing No. 9,	Epicenter Map of Southern California Earthquakes (1800-1999)	11
Drawing No. 10,	Seismic Hazard Zones Map.....	12
Drawing No. 11,	Site-Specific Design Response Spectrum.....	16
Drawing No. 12,	Recommended Limits of Over-Excavation and Re-Compaction with Geofabric Reinforcement	22

APPENDICES

Appendix A Field Exploration
Appendix B Laboratory Testing Program
Appendix C Liquefaction/Seismic Settlement Analysis
Appendix D Earthwork Specifications

1.0 INTRODUCTION

This report contains the findings and recommendations of our geotechnical study performed at the site of the proposed Lot R Tennis and Parking Structure at Student Parking Lot R located within the campus of Mt. San Antonio College, in the City of Walnut, Los Angeles County, California, as shown on Drawing No. 1, *Site Location Map*.

The purpose of the investigation was to generate a report for design and the Department of State Architect (DSA) submittal purposes, consistent with current edition of California Education Code, Sections 17212 and 81033, California Building Code, Title 24 CCR, Sections 4-317, 1803 and 1804 and CGS Note 48-Checklist for the review of Engineering Geology and Seismology Reports for California Public Schools, Hospitals and Essential Services Buildings.

We have used a site plan provided to us by your office as a reference for this project. The site plan is included in this report as Drawing No. 2, *Site Plan and Approximate Location of CPTs and Borings*.

This report is written for the project described herein and is intended for use solely by Mt. San Antonio College and its design team. It should not be used as a bidding document but may be made available to the potential contractors for information on factual data only. For bidding purposes, the contractors should be responsible for making their own interpretation of the data contained in this report.

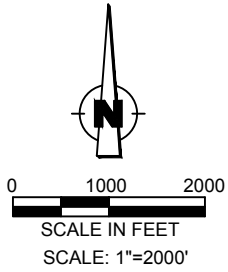

REFERENCE: USGS MAP
 SAN DIMAS QUADRANGLE 1966
 PHOTO REVISED 1981

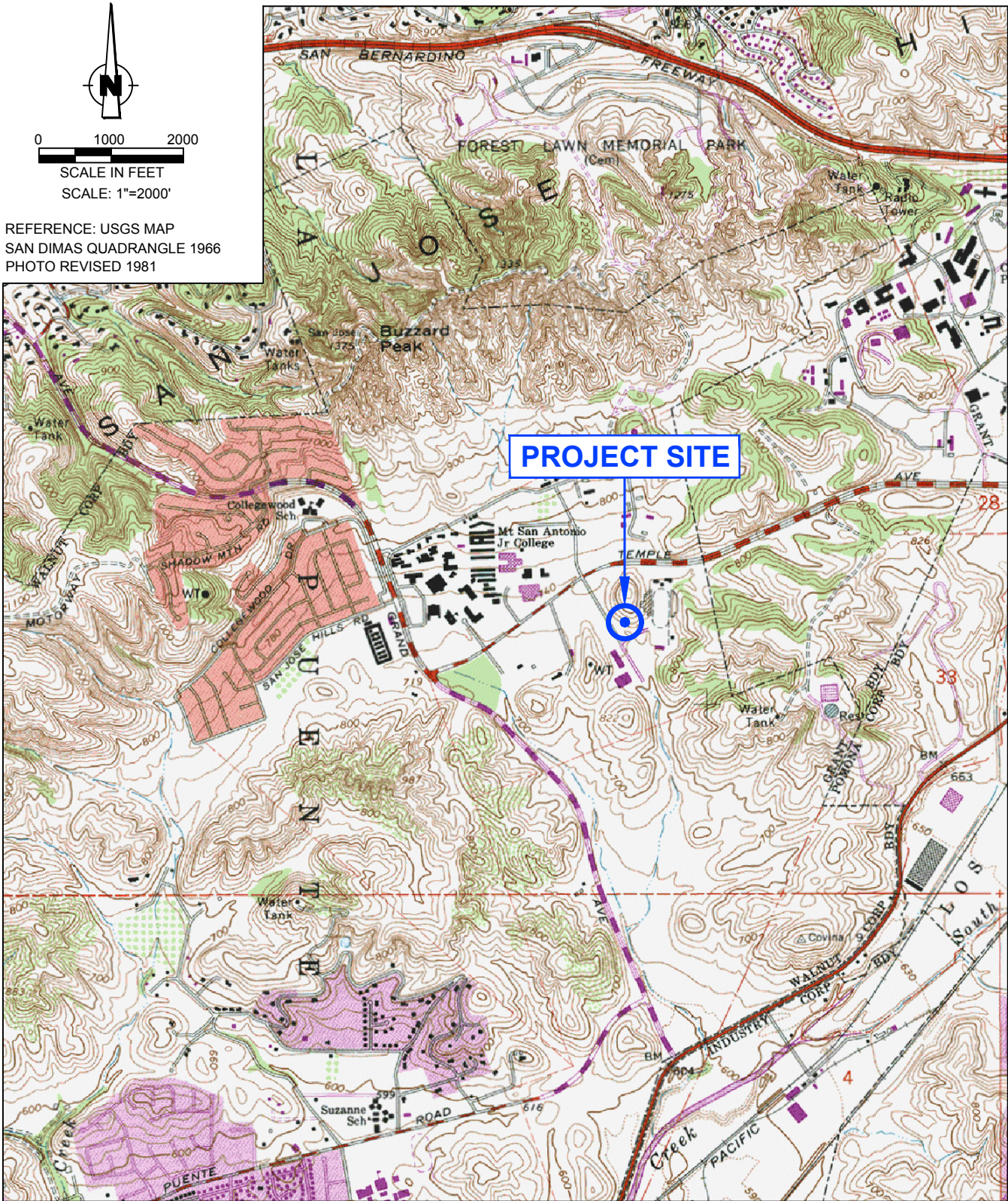

SITE LOCATION MAP

MT. SAN ANTONIO COLLEGE
 LOT R STRUCTURE
 WALNUT, CALIFORNIA



Project No.
 17-31-247-01

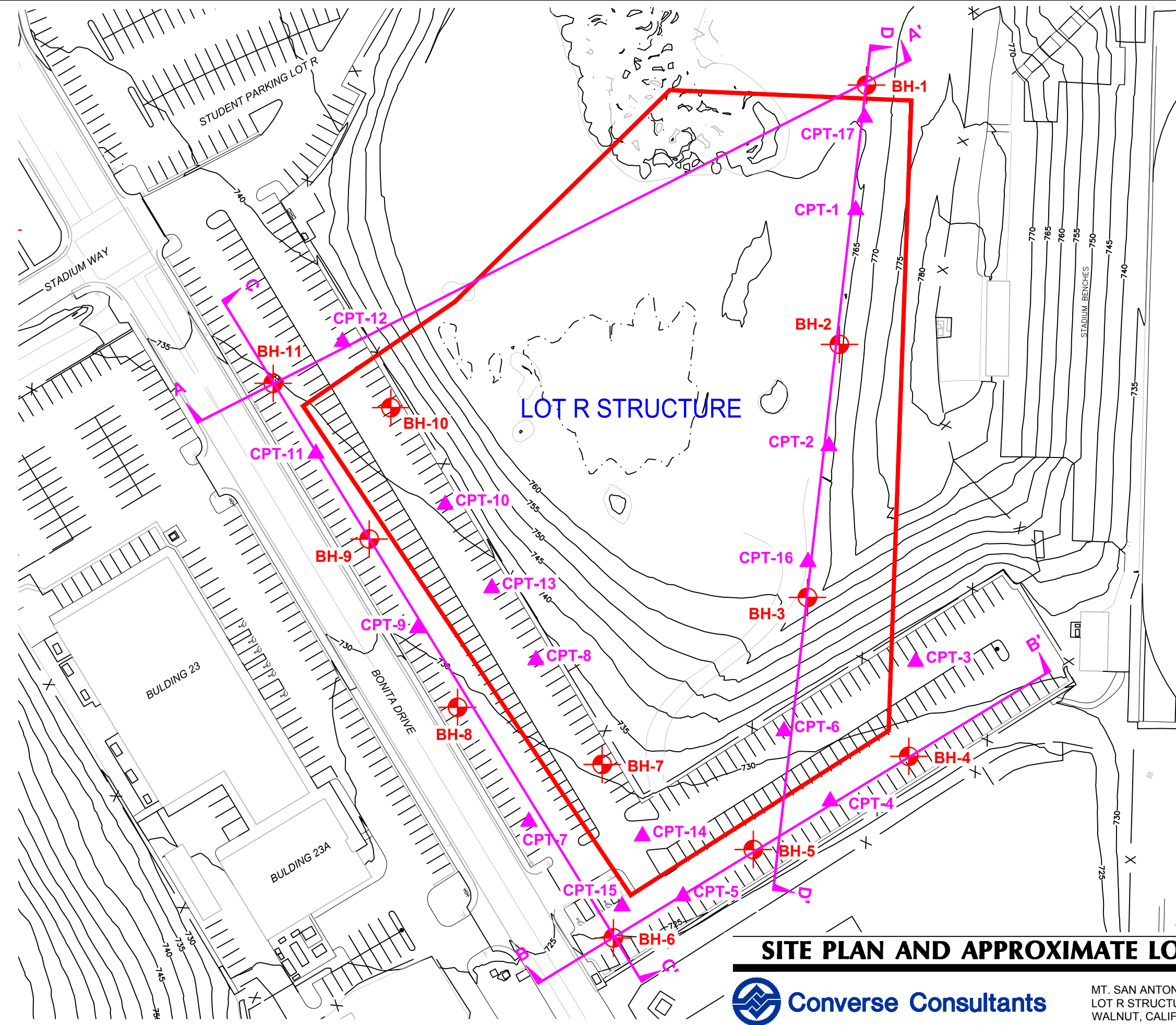

Drawing No.

1



- LEGEND**
-  APPROXIMATE LOCATION OF BORING (AUGUST 2017)
 -  APPROXIMATE LOCATION OF CPT SOUNDINGS (SEPTEMBER 2017)
 -  GEOLOGIC CROSS SECTION A-A', B-B', C-C', AND D-D'

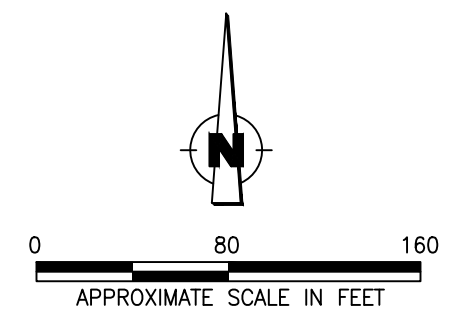

SITE PLAN AND APPROXIMATE LOCATION OF CPT AND BORING

2.0 SITE AND PROJECT DESCRIPTION

2.1 Site Description

The proposed Lot R Tennis and Parking Structure project is located at the current Student Parking Lot R located near the southeast corner of the intersection of West Temple Avenue and Bonita Drive in Mt. San Antonio College (Mt. SAC). The Lot R Tennis and Parking Structure will be located between the new Fieldhouse and Bonita Drive, and is part of the Athletics Complex East (ACE) project currently under construction. The proposed parking lot dimensions are up to approximately 650 feet long in a north-south direction by 200 feet to 480 feet wide in an east-west direction. The site is bordered by West Temple Avenue to the north, Bonita Drive service road to the west and the Hilmer Lodge Stadium to the east.

The subject site for the proposed parking structure has current surface elevations ranging from approximately 725 to 780 feet relative to mean-sea-level (MSL) respectively, with surface gradients flowing down gradient toward the southwest. Grading had been performed in 2014 to excavate and remove a large portion of the hilltop area beneath the project site. Approximately 78 feet of the hilltop was excavated and removed from approximate elevation 846 feet down to approximate elevation 765 feet. The excavated earth materials were transported to the south end of the campus and used as engineered fill for a student parking area. Additional excavation and removals up to approximately 49 feet from elevation 780 feet down to elevation 731 feet are still planned for the former hilltop area. The site coordinates are: North latitude: 34.04546 degrees, West longitude: 117.83831 degrees.

The site coordinates were centered on the subject sites and used to calculate the earthquake ground motions. Review of the Engineering Geology and Seismology for Public Schools and Hospitals in California, indicates that accuracy to within a few hundred meters of these coordinates is sufficient for the computation of the earthquake ground motion of the project site.

2.2 Project Description

The proposed Lot R Tennis and Parking Structure consists of a new two-level parking structure building. The parking structure footprint measures up to 650 feet long in a north-south direction and approximately 200 feet and 480 feet wide in an east-west direction and has a Level 1 footprint of approximately 199,920 square feet. The structural loads are not known at this time, but are anticipated to be moderate. The structure is planned to be founded on shallow spread foundations, columns and concrete mat foundations. The project site is shown on Drawing No. 2, *Site Plan and Approximate Location of CPTs and Borings*.

3.0 SCOPE OF WORK

The scope of our work included a site reconnaissance, subsurface exploration with soil sampling, laboratory testing, engineering analysis, and preparation of this report.

3.1 Site Reconnaissance

During the site reconnaissance from August 14 to August 18, 2017, the surface conditions were noted, and the locations of the borings were determined so that the hollow stem auger drill rig and Cone Penetration Test (CPT) test rig could access the proposed soil boring and CPT locations. The borings and CPT soundings were located using existing boundary features and existing topography as a guide and should be considered accurate only to the degree implied by the method used. Underground Service Alert (USA) of Southern California was then notified of our proposed boring and CPT test locations at least 48 hours prior to initiation of the subsurface field work.

3.2 Subsurface Exploration

Eleven (11) exploratory borings (BH-1 through BH-11) were drilled within the project site from August 18 to August 24, 2017. The borings were advanced using a truck mounted drill rig with an 8-inch diameter hollow stem auger to depths ranging from 30 to 80 feet below the existing ground surface (bgs). Each boring was visually logged by a Converse engineer and sampled at regular intervals and at changes in subsurface soils and bedrock. Detailed descriptions of the field exploration and sampling program are presented in Appendix A, *Field Exploration*. California Modified Sampler (Ring samples), Standard Penetration Test (SPT) samples, and bulk soil samples were obtained for laboratory testing.

Standard Penetration Tests (SPTs) were performed in selected borings at selected intervals using a standard (1.4 inches inside diameter and 2.0 inches outside diameter) split-barrel sampler. The SPT sampler was driven into the ground with successive drops of a 140-pound hammer falling 30 inches by means of a mechanically driven drop hammer. The number of successive drops of the driving weight (“blows”) required for every 6-inches of penetration of the sampler are shown on the Logs of Borings in the “blows column. The bore holes were then backfilled and compacted with soil cuttings by reverse spinning of the auger following the completion of drilling and patched with asphalt patch where necessary to match existing conditions.

Seventeen (17) Cone Penetration Test soundings (CPT-1 through CPT-17) were advanced to depths of 25 feet to 75 feet below ground surface within project site on September 6 and 7, 2017 by Kehoe Testing and Engineering using a 30-ton (4 axle) CPT rig. The cone penetration testing consisted of pushing an instrumented cone-tipped probe into the ground while simultaneously recording the resistance to penetration at the cone tip and along the friction sleeve. The test holes were stopped at plan depths or when the

cone tip encountered refusal to penetration. The test holes were then backfilled with bentonite crumbles, periodically hydrated with clean water and tamped. The top portion of the test hole was then backfilled and tamped with site soil materials to match the existing ground surface conditions.

The approximate locations of the exploratory borings and CPT test soundings are shown in Drawing No. 2, *Site Plan and Approximate Location of CPTs and Borings*. Detailed descriptions of the field exploration and sampling program are presented in Appendix A, *Field Exploration*.

3.3 Laboratory Testing

Representative samples of the site soils were tested in the laboratory to aid in the classification and to evaluate relevant engineering properties. The tests performed included:

- In Situ Moisture Contents and Dry Densities (ASTM Standard D2216)
- Grain Size Distribution (ASTM Standard C136)
- Fines Content/Passing No. 200 Sieve (ASTM D1140)
- Maximum Dry Density and Optimum-Moisture Content Relationship (ASTM Standard D1557)
- Direct Shear (ASTM Standard D3080)
- Consolidation (ASTM Standard D2435)
- R-value (ASTM Standard D2844)
- Soil Corrosivity Tests (Caltrans 643, 422, 417, and 532)
- Atterberg Limits (ASTM Standard D4318)

For a description of the laboratory test methods and test results, see Appendix B, *Laboratory Testing Program*. For *in-situ* moisture and density data, see the Logs of Borings in Appendix A, *Field Exploration*.

3.4 Engineering Analyses and Report

Data obtained from the exploratory fieldwork and laboratory-testing program were analyzed and evaluated. This report was prepared to provide the findings, conclusions and recommendations developed during our investigation and evaluation.

4.0 GEOLOGIC CONDITIONS

4.1 Regional Geology

The proposed project site is located in the San Jose Hills along the western edge of the Pomona Valley within the Transverse Ranges geomorphic province of California and along the northern terminus of the Peninsular Ranges Province.

The Pomona Valley is situated at the junction of the two major convergent fault systems: 1) Northwest-trending high angle strike slip faults of the San Andreas system projecting from the northern terminus of the Peninsular Ranges Province, and 2) East-trending low angle reverse or reverse-oblique faults bounding the south margin of the Transverse Ranges. Faults in group one include the Palos Verdes, Newport-Inglewood, Whittier-Elsinore and San Jacinto fault zones. Group two faults include the Malibu-Santa Monica, Hollywood, Raymond, Sierra Madre and Cucamonga fault zones.

The Pomona Valley basin is bounded to the north by the San Jose fault and to the southwest by the Chino-Central Avenue fault. These two fault systems do not exhibit significant evidence of surface movement within Holocene time (0-11,700 years before present) and are not considered active based on current geologic information. The San Jose and Chino-Central Avenue faults are considered Late Quaternary age faults, having exhibited displacement and movement within the past approximately 130,000 years.

The Geologic Map of the San Dimas and Ontario Quadrangles prepared by Thomas W. Dibblee, Jr. (DF-91, dated July 2002) was reviewed. The map shows the location of Mt. San Antonio College campus within an alluvial basin surrounded by hillsides consisting of sedimentary bedrock of the Monterey (Puente) Formation. No faults are shown running through or projecting through the project site. Low lying sedimentary bedrock hillsides with intervening alluvial filled valleys are depicted on and around the project site. The hillsides beneath the project site and east of the subject site and have been mapped as (Tmy)-Yorba Shale Member consisting of thinly bedded, diatomaceous, semi-siliceous clay shale, siltstone and minor sandstone and (Tscs) Sycamore Canyon Formation consisting of light gray sandstone that includes conglomerate and siltstone. A portion of the map by Thomas W. Dibblee has been reproduced and is shown as Drawing No. 3, *Regional Geologic Map*.

4.2 Subsurface Profile of Subject Site

The earth materials encountered during our investigation consisted of existing fill soils (Af) placed during previous site grading operations, natural alluvial soils (Qal) and sedimentary bedrock of the Puente Formation (Tpss). The project site was previously graded in 2014 to excavate and remove a large portion of the hilltop within the project site. Approximately 81 feet of the hilltop was excavated and removed from approximate elevation 846 feet down to approximate elevation 765 feet. Additional excavation and

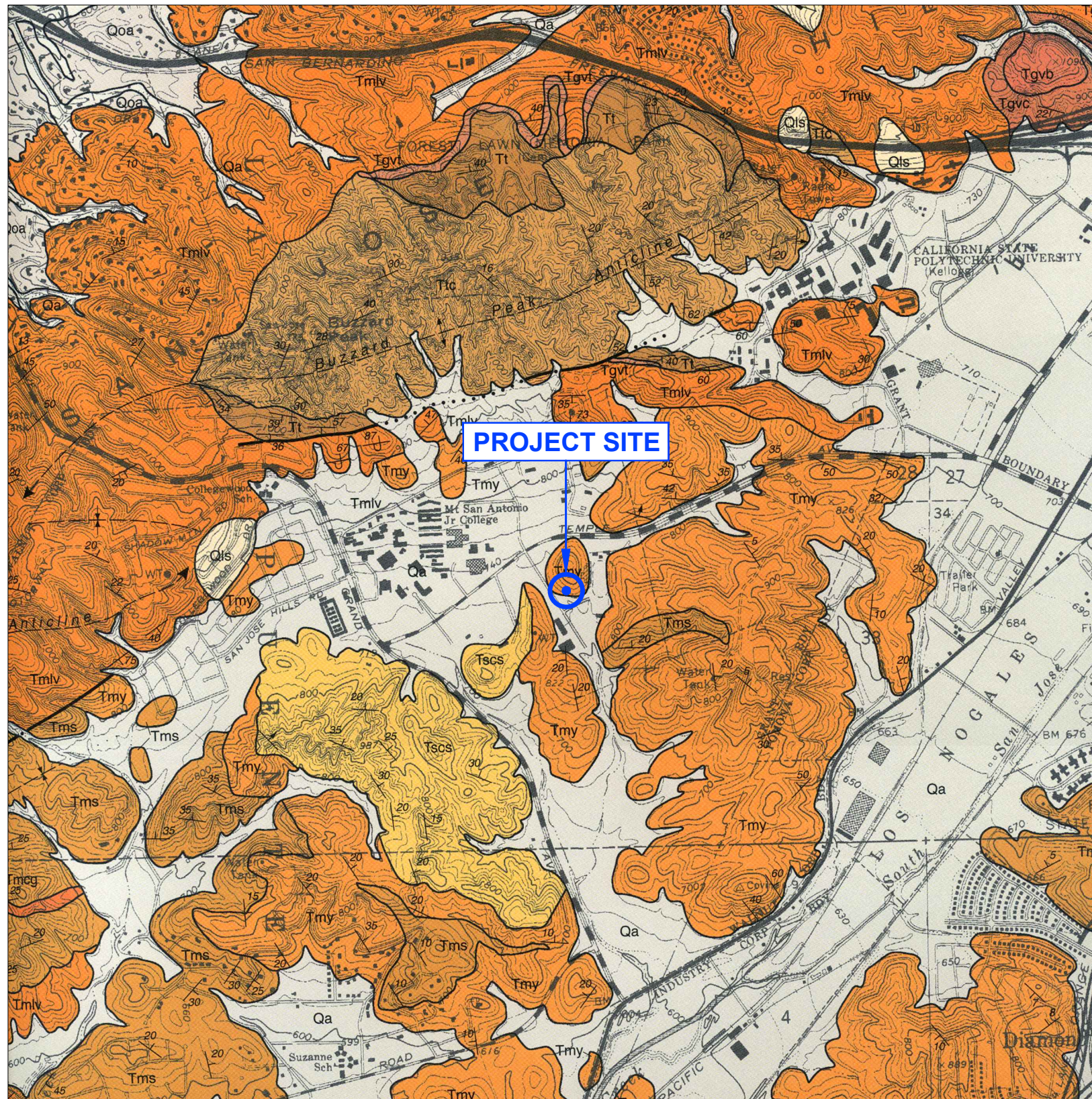
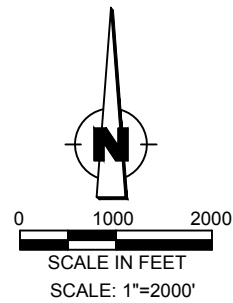

SAN DIMAS AND ONTARIO MAP (DF-91)

LEGEND

<p>SURFICIAL SEDIMENTS</p> <p>af artificial fill Qg alluvial gravel and sand of stream channels, some artificially channelized Qa alluvial gravel and sand of valley areas</p> <p>LANDSLIDE AND TALUS RUBBLE</p> <p>— UNCONFORMITY —</p> <p>OLDER, DISSECTED SURFICIAL SEDIMENTS</p> <p>Qoa low remnants of elevated alluvial gravel Qog high remnants of elevated older alluvial gravel, including coarse boulder gravel</p> <p>— UNCONFORMITY —</p> <p>SEDIMENTARY AND VOLCANIC ROCKS</p> <p>SYCAMORE CANYON FORMATION</p> <p>Sycamore Canyon Formation (uppermost member of Puente Formation of Durham & Yerkes 1964, Tan 1998) shallow marine clastic; latest Miocene age. Tseg conglomerate, light gray, of cobbles and pebbles of plutonic rocks in sandstone matrix. Tscs sandstone, light gray, similar to Tms. Includes some conglomerate similar to Tseg, and siltstone.</p> <p>MONTEREY (PUENTE) FORMATION</p> <p>Monterey Formation (Puente form of Eldridge & Arnold, 1907, Durham & Yerkes 1964; Tan 1998, marine biogenic & clastic; late Miocene age, (Molnian Stage)) Tm unassigned shale; similar to Tmlv & Tmy Tmy Yorba shale Member—light gray, thin bedded, diatomaceous, semi-siliceous to clay shale, siltstone, minor sandstone; fish scales. Tmcg conglomerate facies of cobbles & pebbles of plutonic rocks in sandstone matrix lenses in unit Tms, deposited as submarine deltas. Tms Sequoia sandstone facies, partly intertongued into Tmy & Tmlv, light gray to tan, moderately lithified, bedded, arkosic, contains concretions, some interbedded silty shale, derived from plutonic terrane & deposited as submarine fans, unfossiliferous Tmlv La Vida Shale Member, white, weathered; thin bedded, platy, siliceous shale, clay shale, and siltstone, some strata of tan dolomite and sandstone, fish scales, foraminifera.</p> <p>TOPANGA FORMATION</p> <p>(of Shelton, 1955; Tan, 1998; marine clastic; middle Miocene age, unfossiliferous, locally intertongued into Glendora volcanics), age late ? Miocene Tt sandstone, light gray to tan, moderately lithified, bedded, arkosic, locally pebbly, includes interbedded siltstone or clay shale. Ttc conglomerate (Buzard Peak Conglomerate member of Woodford et al. 1946, light gray to tan, semi-lithified, vaguely bedded, composed of cobbles and pebbles of mostly plutonic rocks in sandstone matrix.</p> <p>GLENDORA VOLCANIC ROCKS</p> <p>Glendora Volcanics (of Shelton, 1955, Tan, 1999; extrusive volcanic rocks; middle Miocene age locally intertongued into Topanga Formation), (radiometric age ±16 MA (Weigand, P.W., oral communication 2001)) Tgv undifferentiated volcanic rock, mostly brown andesitic flows and breccias Tgve volcanic conglomerate, gray to brown, of volcanic detritus. Tgvb basalt flows, gray to black, massive to vesicular. Tgvp basaltic pelagic tuff & pillow lavas. Tgvt rhyolitic tuff breccia, tan to white Tgva andesite flows and low breccias, brown, porphyritic, massive. Tgvr rhyolitic-dacitic flows, tan to light brown, aphanitic, massive to flow-banded, hard, fractured Tgve rhyolite-dacite breccia exposed only at Elephant Hill.</p> <p>— UNCONFORMITY —</p> <p>CRYSTALLINE BASEMENT ROCKS</p> <p>GRANITIC ROCKS</p> <p>MOUNTAIN MEADOWS DACITE</p> <p>Mountain Meadows dacite (of Shelton 1955, Tan, 1999 intrusive into qd; early Miocene? Age) Mda dacite light gray, hard, massive, fine grained, contains small feldspar phenocrysts and biotite flakes.</p> <p>QUARTZ DIORITIC PLUTONIC ROCKS</p> <p>quartz diorite; plutonic igneous rock, late Mesozoic- Cretaceous age qd biotite quartz diorite, light gray, massive. qdb Borsari Tonalite of Larson 1948 similar to qd, but slightly gneissoid & contains dark gray fine grained xenoliths elongated parallel to gneissoid structure up to 9 in. long.</p>	<p>Holocene</p> <p>QUATERNARY</p> <p>Pleistocene</p> <p>Miocene</p> <p>TERTIARY</p> <p>CENOZOIC</p> <p>CEOUS</p> <p>ZOIC</p>
--	--

REFERENCE: THOMAS W. DIBBLE, Jr. (DF-91)
SAN DIMAS QUADRANGLE
AND ONTARIO QUADRANGLE (2002)

REGIONAL GEOLOGIC MAP



MT. SAN ANTONIO COLLEGE
LOT R STRUCTURE
WALNUT, CALIFORNIA

Project No. Drawing No.
17-31-247-01 **3**

removals up to approximately 49 feet from elevation 780 feet down to elevation 731 feet are still planned for the former hilltop area. Existing soil materials from other projects on campus have been stockpiled for later use on top of the current hilltop (elevation 760 feet). The previous graded parking lot areas along the west and south sides of the project are covered by a layer of fill soils underlain by the alluvial soils and interbedded layers of sandstone, pebble conglomerate, siltstone, and claystone sedimentary bedrock of the Puente Formation. These earth materials consist primarily of silty sands, clayey sands, sands, silts and clays. Each of these earth materials is described in more detail below.

Fill Soils (Af)

An undocumented fill layer of variable thickness was encountered in soil borings BH-4, BH-5, BH-6, BH-7, BH-8, BH-9 and BH-11 drilled between August 18 to August 24, 2017, within the subject site. The depth of the fill ranges from approximately five (5) to ten (10) feet in thickness. Deeper fill soils may be encountered at the project site. The observed fill soils consist primarily of silty clay, clayey sand and clayey silt. Most of the fill soils appear to have been locally derived from the general site area and were placed beneath the former parking lot areas. Documentation concerning the placement and degree of compaction of the fill soils was not available.

Alluvium (Qal)

Alluvial deposits were encountered underlying the fill material at the project site. The native soil encountered in the borings consists of clayey sands, sandy clays, sandy silts, silty clays, silts and clays with occasional gravels and cobbles. The deepest alluvium was located on the west side of the project site along Bonita Drive. Sampling blow-counts correlate from loose and medium stiff to dense and very stiff. Dark brown, fine-grained silts and clays were encountered above the alluvium / bedrock contact. These natural soil materials are potentially expansive and not recommended for use as fill directly below footings and slabs. The soils also include occasional fragments of weathered bedrock. We expect that some cobbles and rocks are larger in size than the largest observed, (approximately four (4) inches in the maximum dimension) and were broken down in the hollow stem auger soil cuttings. Based on our previous experience and knowledge of the area, and materials encountered during subsurface exploration, cobbles greater than eight (8) inches and occasional boulders may be buried in the alluvial sediments below the site.

Interbedded Siltstone, Claystone and Sandstone Bedrock (Tpss)

The sedimentary bedrock on Lot R Tennis and Parking Structure site is underlain by sedimentary bedrock of Puente Formation (Tpss and Tpcg) consisting of interbedded siltstone, claystone, sandstone, and pebble conglomerate layers. The bedrock beneath the hillside area consists of well stratified sedimentary bedrock assigned to the Puente Formation. The bedrock materials are Miocene-age and estimated to be at least 25 million years old. The bedrock consists of interbedded layers of siltstone, claystone, sandstone

and pebble conglomerate that were originally deposited as horizontal strata in a marine environment. The bedrock layers have undergone tectonic deformation, uplift and tilting over the past 25 million years. The gross bedrock structure beneath the subject hillside forms a uniformly northwest dipping monoclinical structure with local small amplitude folding. The bedrock bedding structure generally strikes northeast and dips between 44 to 65 degrees to the northwest (Converse, 2007, 2013). The bedrock consists of laminated to thinly bedded, stratified layers of interbedded siltstone, claystone, sandstone and shales. The sedimentary bedrock becomes less weathered with depth and is of low to moderate hardness. The hollow stem auger borings were drilled to the planned depths in the bedrock materials. The samplers (Ring and SPT) met increased sampling resistance with depth. The CPT soundings met very dense/ stiff conditions in the bedrock materials and were stopped short of their plan depths to prevent CPT damage.

The sedimentary bedrock materials produce low to moderate expansive soil materials when excavated, processed and mixed for use as fill. The bedrock material also contains diatomaceous layers that can influence moisture contents and densities when mixed and used as fill materials.

Sandstone and Pebble Conglomerate Bedrock (Tpcg)

Hard sandstone and conglomerate bedrock layers consisting of gravel and cobble-sized rocks in a cemented sandstone matrix (Tpcg) were encountered at shallow depths along the north side of hillside beyond the current Lot R structure location. The sandstone and conglomerate layers can be thick and massive and may contain boulder sized hard rock materials. The sandstone and conglomerate bedrock materials were observed to be hard and will be more difficult to excavate during grading and construction.

Drawing No.4, *Geologic Cross Section A-A'*, Drawing No.5, *Geologic Cross Section B-B'*, Drawing No.6, *Geologic Cross Section C-C'* and Drawing No.7, *Geologic Cross Section D-D'*, have been drawn across the subject site to illustrate the subsurface conditions beneath the project site. For additional information on the subsurface conditions, see the Logs of Boring Data in Appendix A, *Field Exploration*.

4.3 Groundwater

Local zones of groundwater seepage and groundwater were encountered during subsurface exploration in the alluvium and bedrock in Borings BH-3, BH-4, BH-5, BH-6, BH-7, BH-8, BH-9 and BH-11 at depths ranging from approximately 20 feet below ground surface in Boring BH-6 to approximately 60 feet in Boring BH-3. The groundwater levels encountered during drilling ranged between approximate elevations 696 feet and 713 feet. The regional groundwater table is not expected to be encountered during the planned grading and construction. However, the possibility of groundwater being encountered during future grading and deeper excavations cannot be completely precluded.

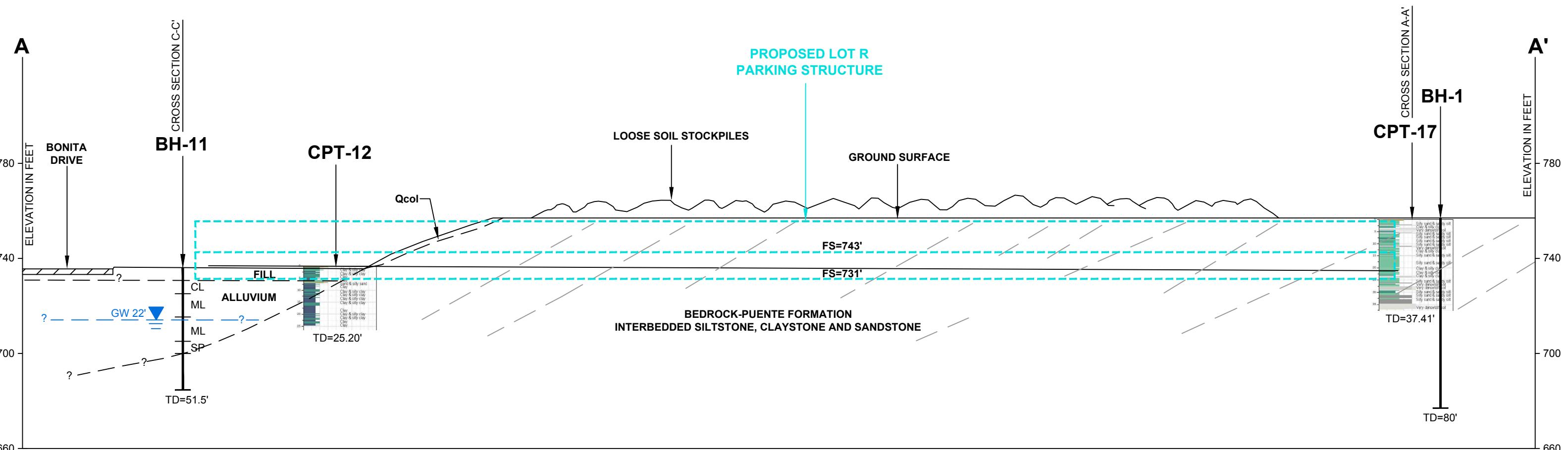

PROFILE:
HORIZONTAL: 1"=40'
VERTICAL: 1"=40'

GEOLOGIC CROSS SECTION A-A'



MT. SAN ANTONIO COLLEGE
LOT R STRUCTURE
WALNUT, CALIFORNIA

Project No.
17-31-247-01

Drawing No.
4

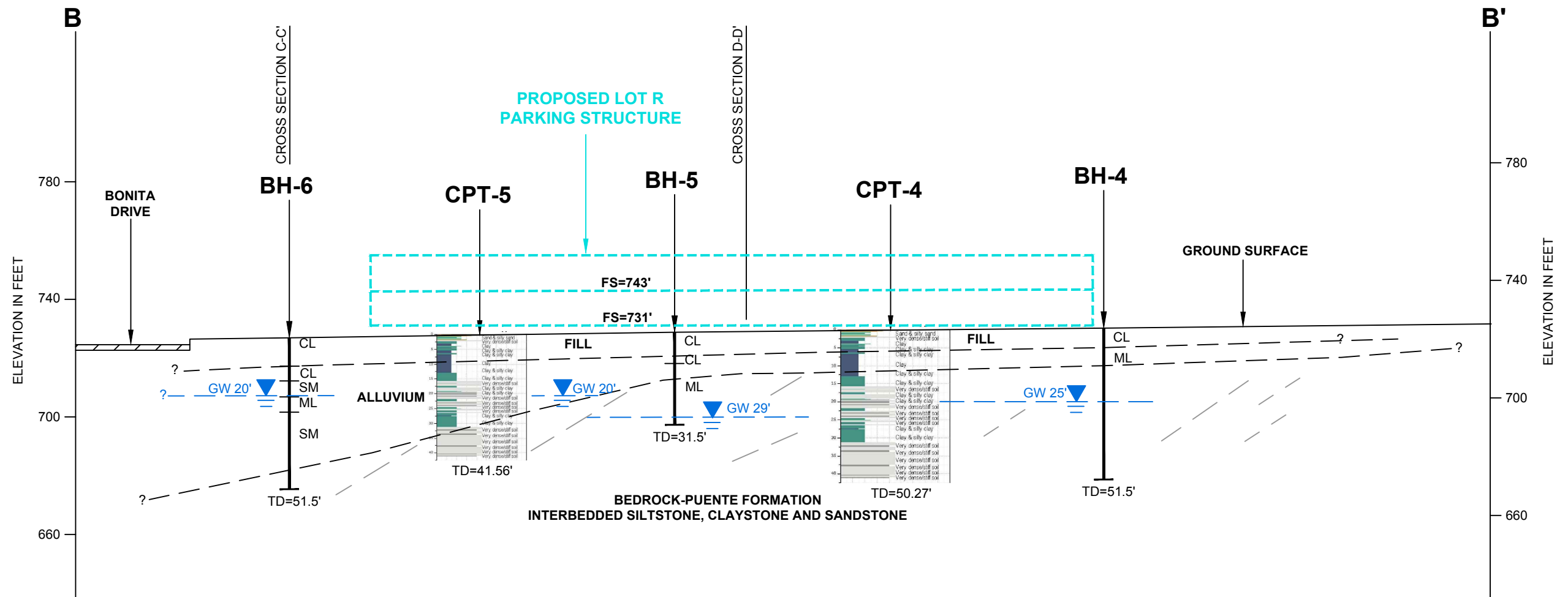

PROFILE:
 HORIZONTAL: 1"=40'
 VERTICAL: 1"=40'

GEOLOGIC CROSS SECTION B-B'

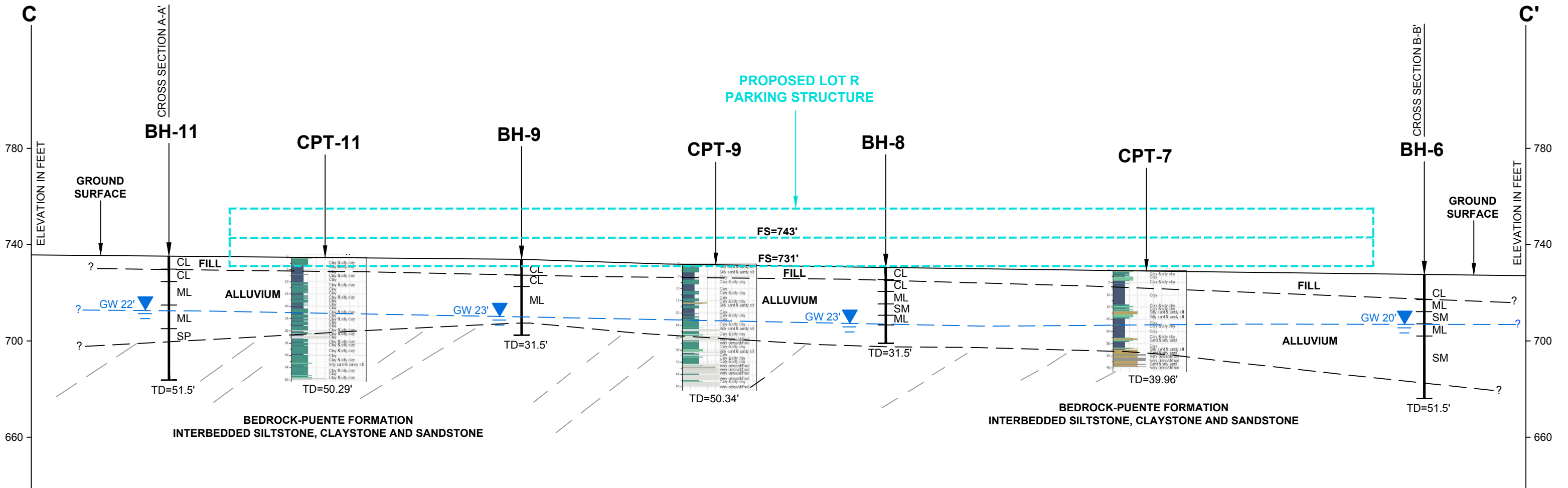

PROFILE:
 HORIZONTAL: 1"=40'
 VERTICAL: 1"=40'

GEOLOGIC CROSS SECTION C-C'

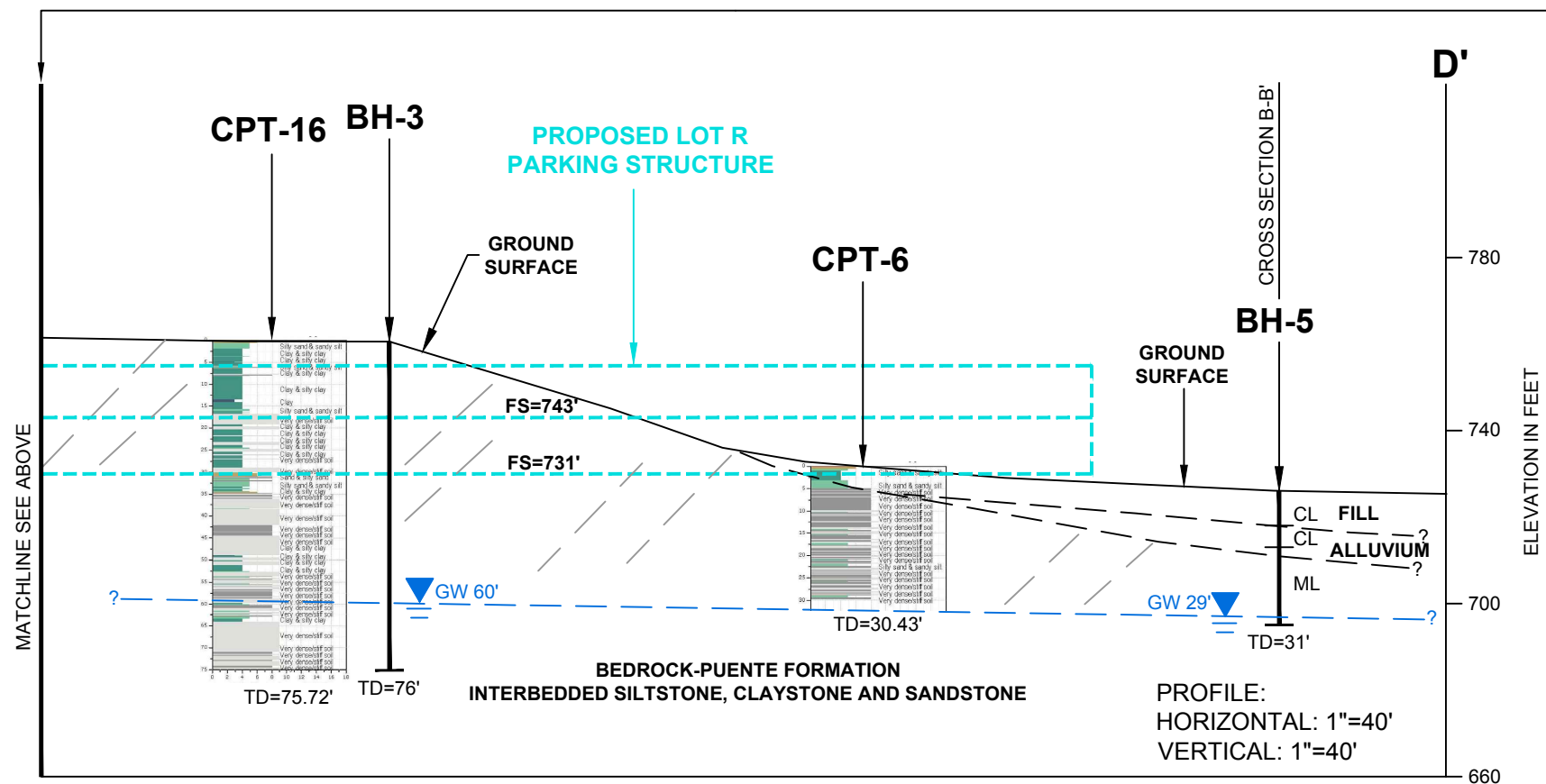
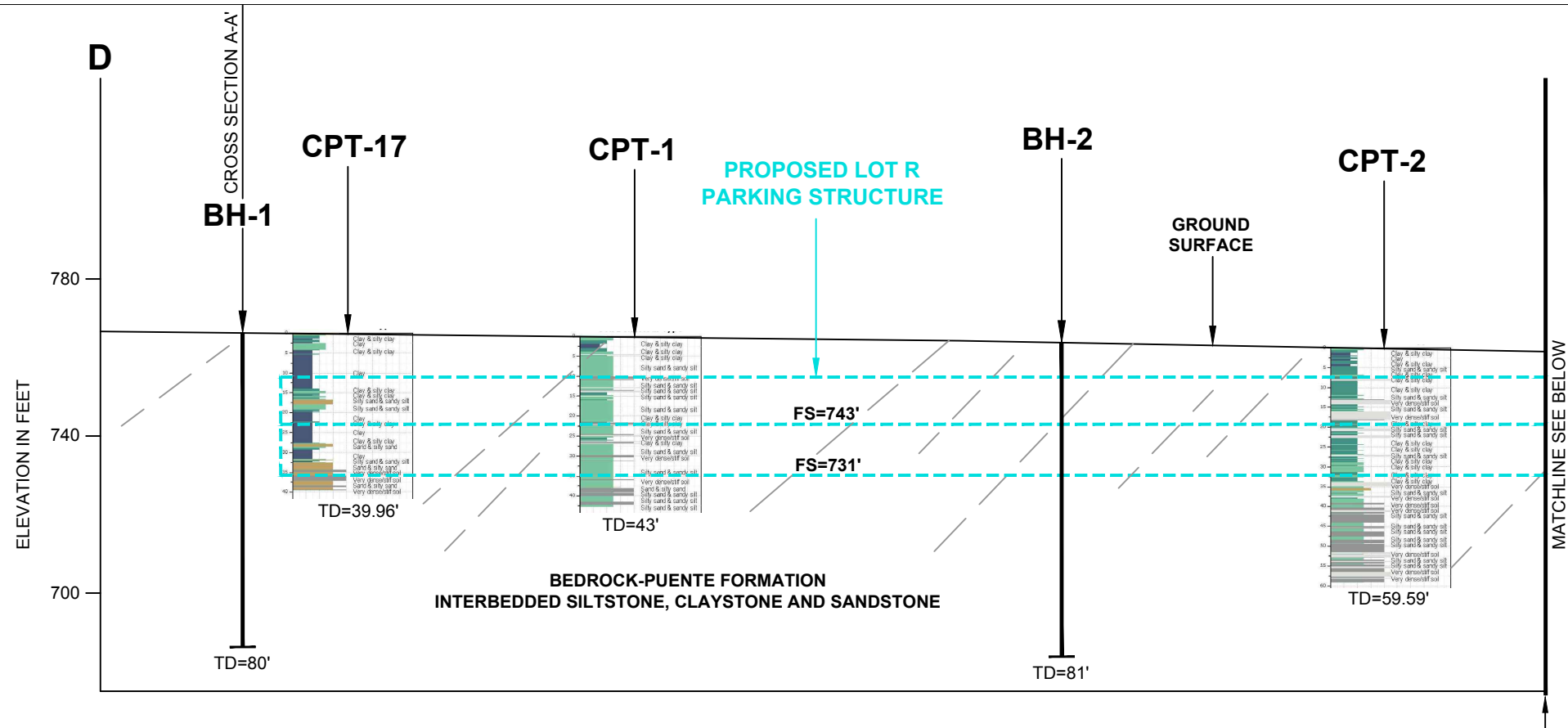

GEOLOGIC CROSS SECTION D-D'

Wet weather periods may produce groundwater seepage in the bedrock fractures and along less permeable layers in the alluvium from upslope infiltration of rainfall, surface flow, runoff and storm water recharge and should be anticipated during grading and construction. Local zones of perched groundwater may be present within the near-surface deposits due to buried alluvial channel features, channel remnants, alluvium/bedrock contacts, local recharge conditions or during the rainy season. In general, groundwater levels fluctuate with the seasons. Groundwater conditions below any given site vary depending on numerous factors including seasonal rainfall, local irrigation, storm water recharge and groundwater pumping, among other factors.

4.4 Subsurface Variations

Based on results of the subsurface exploration and our experience with the subject area, some variations in the continuity and nature of subsurface conditions within the project site are anticipated. Because of the uncertainties involved in the nature and depositional characteristics of the earth material at the site, care should be exercised in interpolating or extrapolating subsurface conditions between or beyond the boring locations. If, during construction, subsurface conditions different from those presented in this report are encountered, this office should be notified immediately so that recommendations can be modified, if necessary.

5.0 FAULTING AND SEISMIC HAZARDS

Geologic hazards are defined as geologically related conditions that may present a potential danger to life and property. Typical geologic hazards in Southern California include earthquake ground shaking, fault surface rupture, liquefaction and seismically induced settlement, lateral spreading, landslides, earthquake induced flooding, tsunamis and seiches, and volcanic eruption hazard.

Results of a site-specific evaluation for each type of possible seismic hazards are discussed in the following sections.

5.1 Seismic Characteristics of Nearby Faults

No surface faults are known to project through or towards the site. The closest known faults to the project site with mappable surface expressions are the San Jose Fault (0.53 mile / 0.85 kilometer to the north) and Chino-Central Avenue (Elsinore) Fault (6.9 kilometers to the east/ southeast). The concealed Puente Hills Blind Thrust Fault (Coyote Hills segment) along with other regional faults were included as active fault sources for the probabilistic seismic hazard analysis for the site. The approximate locations of these local active faults with respect to the project site are tabulated on Table No. 1, *Summary of Regional Faults*, and are shown on Drawing No. 3, *Regional Geological Map* and Drawing No. 8, *Southern California Regional Fault Map*.

The Pomona Valley Basin is bounded to the north by the San Jose Fault and to the southwest by the Chino-Central Avenue faults. These two fault systems do not exhibit evidence of surface movement within Holocene time and are not considered active based on current geologic information. The San Jose and Chino-Central Avenue faults are considered Late Quaternary, having exhibited displacement and movement within the past 738,000 years.

San Jose Fault

The San Jose Fault lies along the southern flank of the northeast trending San Jose Hills. The fault trends northeast and dips to the north. The mapped trace of the San Jose Fault is located approximately 0.53 mile / 0.85 kilometer north of the project site.

Geotechnical investigations performed on the campus of California State Polytechnic University at Pomona (Geocon, 2001) indicated that the San Jose is an active reverse separation fault. Because of the lack of success in previous fault trench excavations, Geocon based its conclusions on a series of closely spaced boreholes along several traverses across a subtle topographic bench on the campus. They discovered two shallowly to moderately north-dipping thrust faults with the most recent displacement being about 1 meter and occurred since 3500 yrs. B.P. on the basis of radiocarbon dating

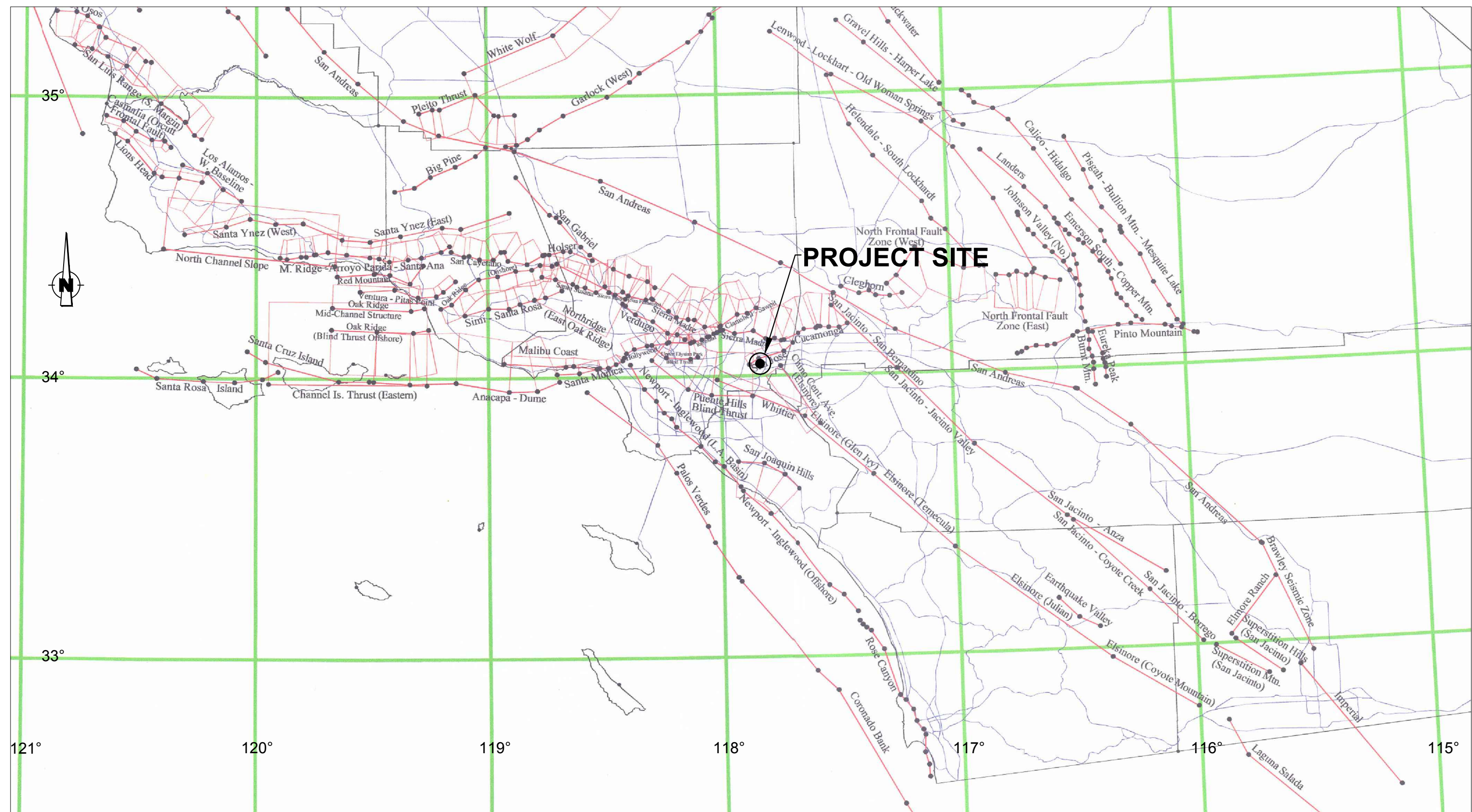

REFERENCE: PORTION OF CGS 2002 CALIFORNIA FAULT MODEL
 MODIFIED FOR USE WITH FRISKSP AND EQFAULT
 BY THOMAS F. BLAKE, AUGUST 2004

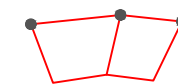
-  FAULT SOURCES
-  BLIND THRUST FAULT,
POLYGONS INDICATE RUPTURE
PLANES AND DIP DIRECTION

SOUTHERN CALIFORNIA REGIONAL FAULT MAP



MT. SAN ANTONIO COLLEGE
 LOT S STRUCTURE
 WALNUT, CALIFORNIA

Project No.
 17-31-247-01

Drawing No.
8

of faulted alluvium. These findings would show this segment of the fault is active, but is a reverse separation fault south of the San Jose Hills (Yeats, 2004).

Chino-Central Avenue Faults

The Chino and Central Avenue faults trend northwest along the southwest portion of the Chino Basin. The fault lies along the northeast edge of the Puente Hills. The Chino and Central Avenue faults are considered part of the Elsinore fault which is one of the major right lateral strike slip faults of the Peninsular Ranges geomorphic province. The Elsinore fault splits near Prado Dam into the Chino-Central Avenue and Whittier faults. The Chino-Central Avenue faults are two separate fault strands that strike northwest. The Chino fault dips southwest and is at least 18 km in length. The Central Avenue fault is about 8 km in length and concealed by younger alluvial deposits. The Chino and Central Avenue faults converge southward into the much larger Elsinore fault system.

The July 29, 2008 Chino Hills earthquake was a magnitude 5.5 earthquake event that caused moderate ground shaking and some minor damage to the Mt. San Antonio College campus buildings. The earthquake epicenter was located approximately 15 miles southeast of the campus beneath the Chino Hills and at a depth of approximately 9.1 miles (14.6 km) below ground surface.

As is the case for most areas of Southern California, ground-shaking resulting from earthquakes associated with nearby and more distant faults may occur at the project site. During the life of the project, seismic activity associated with active faults can be expected to generate moderate to strong ground shaking at the site.

Table No. 1, *Summary of Regional Faults*, summarizes selected data of known faults capable of seismic activity within 50 kilometers of the site. The data presented below was calculated using EQFAULT Version 3.0 with updated fault data from “The Revised 2002 California Probabilistic Seismic Hazard Maps (Cao et al., 2003)”, Appendix A, and other published geologic data.

Table No. 1, Summary of Regional Faults

Fault Name and Section	Approximate * Distance to Site (kilometers)	Max. Moment Magnitude (Mmax)	Slip Rate (mm/yr)
San Jose*	0.8	6.4	0.50
Chino-Central Ave. (Elsinore)	6.9	6.7	1.00
Elysian Park Blind Thrust*	8.2	6.7	1.50
Puente Hills Blind Thrust**	8.3	7.3	0.70
Sierra Madre*	9.6	7.2	2.00
Whittier	12.6	6.8	2.50
Cucamonga*	13.8	6.9	5.00
Clamshell-Sawpit	19.5	6.5	0.50

Fault Name and Section	Approximate * Distance to Site (kilometers)	Max. Moment Magnitude (Mmax)	Slip Rate (mm/yr)
Raymond	19.6	6.5	1.50
Verdugo*	28.6	6.9	0.50
Elsinore-Glen Ivy	29.1	6.8	5.00
Compton Thrust	29.9	6.8	1.50
Hollywood	36.2	6.4	1.00
San Jacinto – San Bernardino	38.0	6.7	12.00
San Andreas – 1857 Rupture*	39.1	7.4	30.00
San Andreas – Mojave*	39.1	7.4	30.00
Newport-Inglewood (L.A. Basin)*	39.6	7.1	1.00
San Andreas – San Bernardino*	41.0	7.5	24.00
San Andreas – Southern*	41.0	7.2	25.00
Cleghorn*	45.7	6.7	2.00
Sierra Madre (San Fernando)*	48.4	6.7	2.00

*Review of published geologic data and mapping including Appendix A of the 2002 California Fault Parameters Report (Cao et al., 2003). Distance from the site to nearest subsurface projection, per Shaw et al., 2002.

5.2 Seismic History

An analysis of the seismic history of the site was conducted using the computer program EQSEARCH, (Blake, 2000), and attenuation relationships proposed by Boore et al. (1997) for alluvium soil conditions. The Southern California Earthquake Catalog with the Southern California Earthquake Center was also utilized (SCEC, 2011).

Based on the analysis of seismic history, the number of earthquakes with a moment magnitude of 5.0 or greater occurring within a distance of 100 kilometers was 169, since the year 1800. Based on the analysis, the largest earthquake-induced ground acceleration affecting the site since the year 1800 is a 7.0 magnitude earthquake in 1858 with a calculated ground acceleration of 0.24g at the site.

Review of recent seismological and geophysical publications indicates that the seismic hazard for the Pomona Basin is high. The Pomona Basin is bounded by active regional faults on all sides and underlain by alluvial sediments and buried thrust faults. The seismic hazard for the Pomona Basin was illustrated by the 1971 San Fernando, 1987 Whittier Narrows, 1991 Sierra Madre, 1994 Northridge and 2008 Chino Hills earthquakes. The epicenters for these earthquakes are shown on Drawing No. 9, *Epicenter Map of Southern California Earthquakes (1800-1999)*.

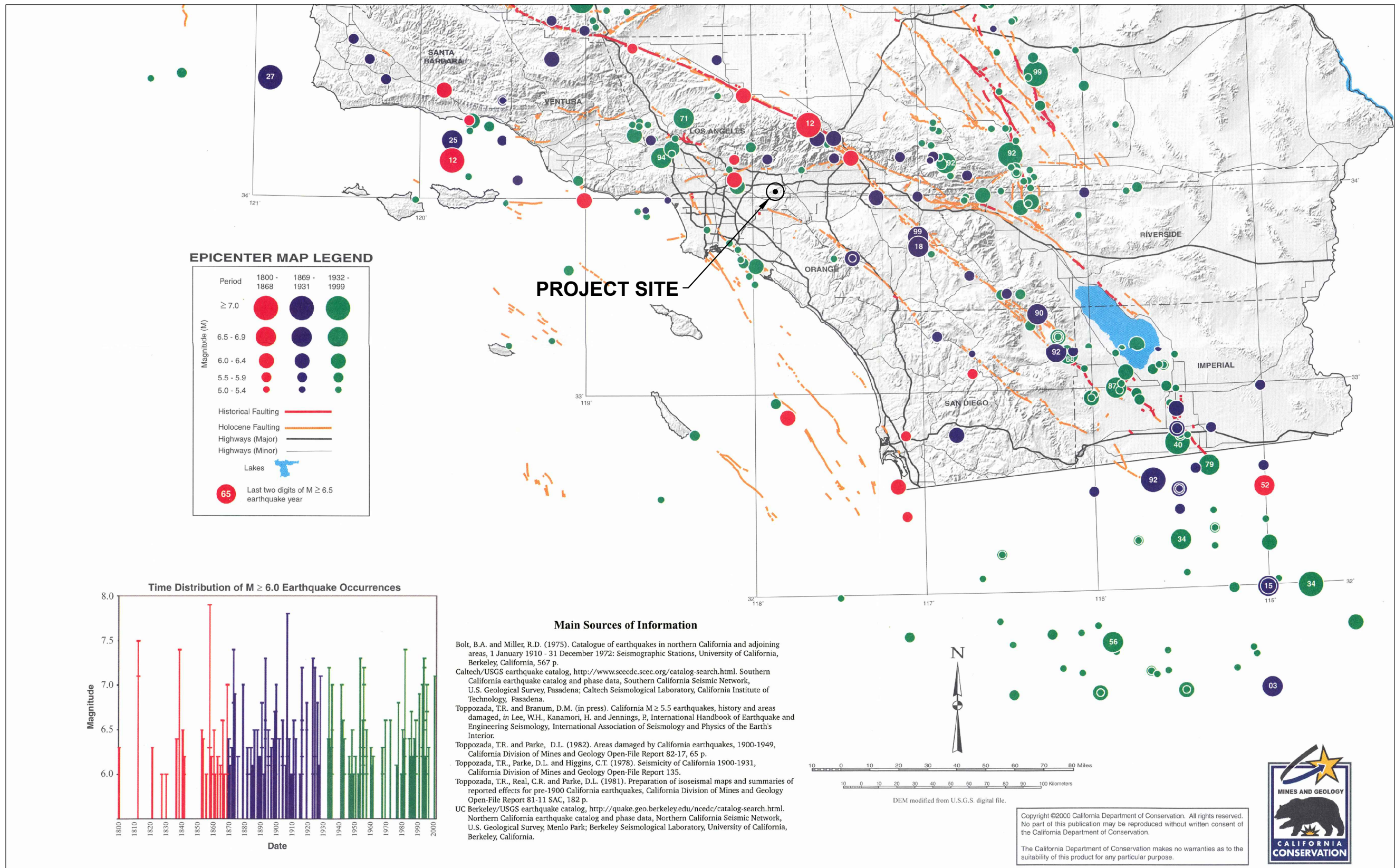

REFERENCE: PORTION OF EPICENTERS AND AREAS DAMAGED BY M≥5 CALIFORNIA EARTHQUAKES, 1800-1999 CALIFORNIA DEPARTMENT OF CONSERVATION, MAP SHEET 49 DATED 2000.

EPICENTER MAP OF SOUTHERN CALIFORNIA EARTHQUAKES (1800-1999)



MT. SAN ANTONIO COLLEGE
 LOT R STRUCTURE
 WALNUT, CALIFORNIA

Project No.
 17-31-247-01

Drawing No.
 9

Copyright ©2000 California Department of Conservation. All rights reserved. No part of this publication may be reproduced without written consent of the California Department of Conservation.
 The California Department of Conservation makes no warranties as to the suitability of this product for any particular purpose.



5.3 Surface Fault Rupture

The project site is not located within a currently designated State of California Earthquake Fault Zone (formerly Alquist-Priolo Special Studies Zones) for surface fault rupture. The Alquist-Priolo Earthquake Fault Zoning Act requires the California Geological Survey to zone “active faults” within the State of California. An “active fault” has exhibited surface displacement with Holocene time (within the last 11,000 years) hence constituting a potential hazard to structures that may be located across it. Public school structures are required to be set-back at least 50 feet from an active fault. The active fault set-back distance is measured perpendicular from the dip of the fault plane. Based on a review of existing geologic information, no known active faults project through or toward the site. The potential for surface rupture resulting from the movement of the nearby major faults is considered remote.

5.4 Liquefaction and Seismically-Induced Settlement

Liquefaction is the sudden decrease in the strength of cohesionless soils due to dynamic or cyclic shaking. Saturated soils behave temporarily as a viscous fluid (liquefaction) and, consequently, lose their capacity to support the structures founded on them. The potential for liquefaction decreases with increasing clay and gravel content, but increases as the ground acceleration and duration of shaking increase. Liquefaction potential has been found to be the greatest where the groundwater level and loose sands occur within 50 feet of the ground surface.

The western and southern sections of the proposed Lot R structure site along Bonita Drive are underlain by alluvial sediments that are located within a potential liquefaction zone per the State of California Seismic Hazard Zones Map for the San Dimas Quadrangle as shown in Drawing No. 10, *Seismic Hazard Zones Map*. Liquefaction analyses were performed using *LiquefyPro*, Version 5.8d, 2009, by Civil Tech Software for the upper 50 feet below ground surface utilizing Boring BH-4, BH-6, CPT-9 and BH-11. The results of the liquefaction analysis and a summary of the methods used are presented in Appendix C, *Liquefaction/Seismic Settlement Analysis*.

The results of liquefaction analyses indicate the project site is susceptible to liquefaction. The estimated potential liquefaction induced settlement ranges from 0.43 to 2.58 inches with potential differential settlement ranging from 0.22 to 1.29 inches. The project structural engineer should consider the effects of seismically-induced settlement in the foundation design.

5.5 Lateral Spreading

Seismically induced lateral spreading involves primarily lateral movement of earth materials due to ground shaking. It differs from the slope failure in that complete ground failure involving large movement does not occur due to the relatively smaller gradient of the initial ground surface. Lateral spreading is demonstrated by near-vertical cracks with

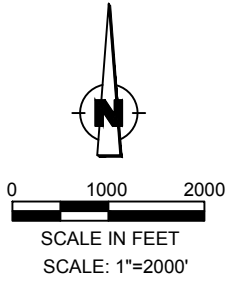

REFERENCE: EARTHQUAKE ZONES OF REQUIRED INVESTIGATION, CALIFORNIA GEOLOGICAL SURVEY, SAN DIMAS QUADRANGLE, SEISMIC HAZARD ZONE 1999

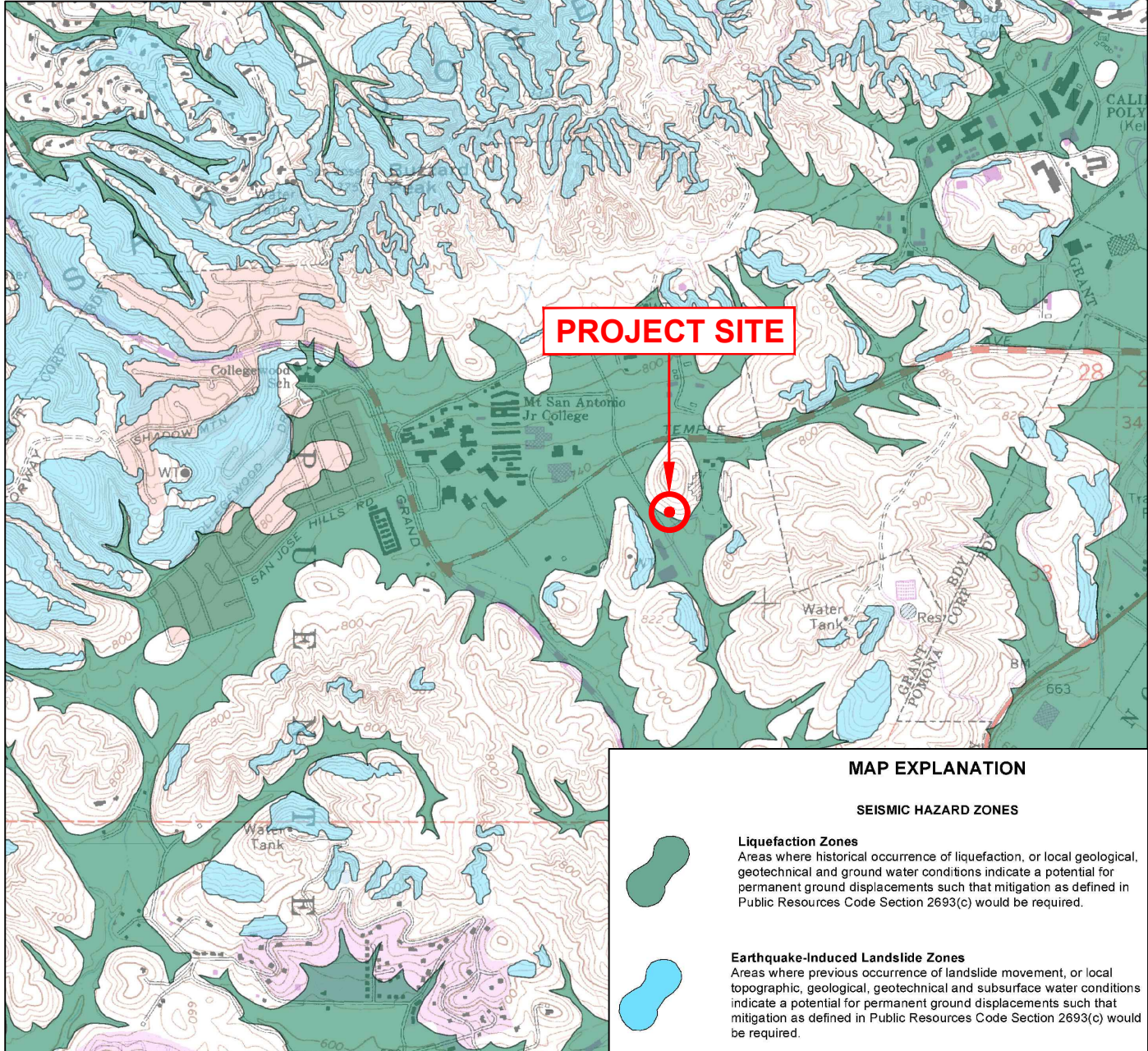
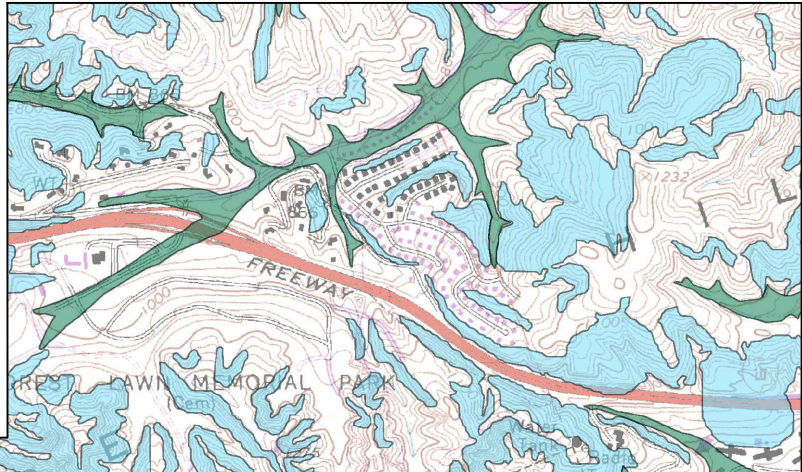

PROJECT SITE

MAP EXPLANATION

SEISMIC HAZARD ZONES

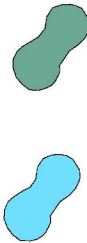

Liquefaction Zones

Areas where historical occurrence of liquefaction, or local geological, geotechnical and ground water conditions indicate a potential for permanent ground displacements such that mitigation as defined in Public Resources Code Section 2693(c) would be required.

Earthquake-Induced Landslide Zones

Areas where previous occurrence of landslide movement, or local topographic, geological, geotechnical and subsurface water conditions indicate a potential for permanent ground displacements such that mitigation as defined in Public Resources Code Section 2693(c) would be required.

SEISMIC HAZARD ZONES MAP

predominantly horizontal movement of the soil mass involved. The topography at the project site and in the immediate vicinity of the site is gently sloping to the southwest, with no significant nearby slopes or embankments. Under these circumstances, the potential for lateral spreading at the subject site is considered negligible.

5.6 Seismically-Induced Slope Instability

Seismically induced landslides and other slope failures are common occurrences during or soon after earthquakes. The project site is also not shown with any earthquake-induced landslide areas due to the gently, southwest sloping ground condition of the site topography. The hillside slope will be excavated and removed to create a level building pad. In the absence of significant ground slopes, the potential for seismically induced landslides to affect the proposed site is considered to be very low.

5.7 Earthquake-Induced Flooding

Review of the Flood Insurance Rate Map (FIRM), Map Number 0637C1725F, Panel 1725 of 2350, dated September 26, 2008, from the FEMA Map Service Center Viewer, indicates that the site is in an area designated as Zone D, "Areas in which flood hazards are undetermined, but possible." Due to the absence of groundwater at shallow depths, distance of the subject site from large bodies of water and regional flood control structures, the potential for flooding at the subject site is considered remote. The potential of earthquake induced flooding of the subject site is considered to be remote.

5.8 Tsunami and Seiches

Tsunamis are seismic sea waves generated by fault displacement or major ground movement. Based on the location of the site from the ocean (over 20 kilometers), tsunamis do not pose a hazard. Seiches are large waves generated in enclosed bodies of water in response to ground shaking. Based on site location away from lakes and reservoirs, seiches do not pose a hazard.

5.9 Volcanic Eruption Hazard

There are no known volcanoes near the site. According to Jennings (1994), the nearest potential hazards from future volcanic eruptions is the Amboy Crater-Lavic Lake area located in the Mojave Desert more than 120 miles east/northeast of the site. Volcanic eruption hazards are not present.

6.0 SEISMIC ANALYSIS

6.1 CBC Seismic Design Parameters

Seismic parameters based on the 2016 California Building Code are calculated using the United States Geological Survey *U.S. Seismic Design Maps* website application and the site coordinates (34.0455 degrees North Latitude, 117.8383 degrees West Longitude). The seismic parameters are presented below.

Table No. 2, CBC Seismic Design Parameters

Seismic Parameters	2016 CBC
Site Class	D
Mapped Short period (0.2-sec) Spectral Response Acceleration, S_s	2.185 g
Mapped 1-second Spectral Response Acceleration, S_1	0.780 g
Site Coefficient (from Table 1613.5.3(1)), F_a	1.0
Site Coefficient (from Table 1613.5.3(2)), F_v	1.3
MCE 0.2-sec period Spectral Response Acceleration, S_{MS}	2.185 g
MCE 1-second period Spectral Response Acceleration, S_{M1}	1.014 g
Design Spectral Response Acceleration for short period, S_{DS}	1.457 g
Design Spectral Response Acceleration for 1-second period, S_{D1}	0.676 g
Seismic Design Category	E

6.2 Site-Specific Response Spectra

A site-specific response spectrum was developed for the project for a Maximum Considered Earthquake (MCE), defined as a horizontal peak ground acceleration that has a 2 percent probability of being exceeded in 50 years (return period of approximately 2,475 years). The controlling source was determined to be the USGS 2008 California Gridded Source, with an MCE of Mw 7.0 and a deterministic peak ground acceleration (PGA) of 1.01g.

In accordance with ASCE 7-10, Section 21.2 the site-specific response spectra can be taken as the lesser of the probabilistic maximum rotated component of MCE ground motion and the 84th percentile of deterministic maximum rotated component of MCE ground motion response spectra. The design response spectra can be taken as 2/3 of site-specific MCE response spectra, but should not be lower than 80 percent of CBC general response spectra. The risk coefficient C_R has been incorporated at each spectral response period for which the acceleration was computed in accordance with ASCE 7-10, Section 21.2.1.1.

The 2016 CBC mapped acceleration parameters are provided in the following table. These parameters were determined using the United States Geological Survey *U.S.*

Seismic Design Maps website application, and in accordance with ASCE 7-10 Sections 11.4, 11.6, 11.8 and 21.2.

Table No. 3, 2016 CBC Mapped Acceleration Parameters

Site Class	D	Seismic Design Category	E
S_s	2.185	C_{RS}	1.012
S₁	0.780	C_{R1}	1.023
F_a	1	0.08 F_v/F_a	0.104
F_v	1.3	0.4 F_v/F_a	0.520
S_{MS}	2.185	T₀	0.093
S_{M1}	1.014	T_s	0.464
S_{DS}	1.457	T_L	8
S_{D1}	0.676		

A Site-Specific response analysis, using faults within 200 kilometers of the sites, was developed using the computer program EZ-FRISK by Risk Engineering (v. 7.62) and the 2008 USGS Fault Model database. Attenuation relationships proposed by Boore and Atkinson (2008), Campbell and Bozorgnia (2008), Chiou and Youngs (2008) were used in the analysis. These attenuation relationships are based on Next Generation Attenuation (NGA) project model. Maximum rotated components were determined using Huang (2008) method. An average shear wave velocity at upper 30 meters of soil profile (V_{s30}) of 390 meters per second, depth to bedrock of with a shear wave velocity 1,000 meters per second at 150 meters below grade, and depth of bedrock where the shear wave velocity is 2,500 meters per second at 3,000 meters below grade were selected for EZ-Frisk Analysis.

The probabilistic response spectrum results and peak ground acceleration for each attenuation relationship are presented in the following table.

Table No. 4, Probabilistic Response Spectrum Data

Attenuation Relationship	Probabilistic Mean	Boore-Atkinson (2008)	Campbell-Bozorgnia (2008)	Chiou-Youngs (2007)
Peak Ground Acceleration (g)	0.966	0.909	0.910	1.056

Spectral Period (sec)	2% in 50yr Probabilistic Spectral Acceleration (g)			
0.03	1.040	0.987	0.979	1.138
0.05	1.187	1.095	1.130	1.318
0.10	1.712	1.570	1.637	1.908
0.20	2.144	1.998	2.077	2.337
0.30	2.036	1.936	1.918	2.210

Spectral Period (sec)	2% in 50yr Probabilistic Spectral Acceleration (g)			
0.40	1.894	1.854	1.785	2.027
0.50	1.764	1.737	1.702	1.851
0.75	1.406	1.418	1.357	1.442
1.00	1.149	1.136	1.119	1.193
2.00	0.570	0.601	0.569	0.535
3.00	0.369	0.398	0.371	0.330
4.00	0.270	0.286	0.283	0.234

Applicable response spectra data are presented in the table below and on Drawing No. 11, *Site-Specific Design Response Spectrum*. These curves correspond to response values obtained from above attenuation relations for horizontal elastic single-degree-of-freedom systems with equivalent viscous damping of 5 percent of critical damping.

Table No. 5, Site Specific Response Spectrum Data

Period (sec)	2% in 50yr Probabilistic Spectral Acceleration (g)	Risk Coefficient C_R	Probabilistic MCE_R Spectral Acceleration (g)	84th Percentile Deterministic MCE Response Spectra, (g)	Deterministic CBC Lower Level, (g)	Site Specific MCE_R Spectral Acceleration (g)	80% CBC Design Response Spectrum	Site Specific Design Spectral Acceleration (g)
0.03	1.040	1.012	1.052	1.189	0.260	1.052	0.692	0.70
0.05	1.187	1.012	1.201	1.358	0.433	1.201	0.843	0.84
0.10	1.712	1.012	1.733	1.854	0.865	1.733	1.165	1.17
0.20	2.144	1.012	2.170	2.353	1.500	2.170	1.165	1.45
0.30	2.036	1.013	2.063	2.368	1.500	2.063	1.165	1.38
0.40	1.894	1.015	1.922	2.323	1.500	1.922	1.165	1.28
0.50	1.764	1.016	1.792	2.219	1.500	1.792	1.082	1.19
0.75	1.406	1.020	1.434	1.827	1.040	1.434	0.721	0.96
1.00	1.149	1.023	1.175	1.449	0.780	1.175	0.541	0.78
2.00	0.570	1.023	0.583	0.653	0.390	0.583	0.270	0.39
3.00	0.369	1.023	0.377	0.391	0.260	0.377	0.180	0.25
4.00	0.270	1.023	0.276	0.292	0.195	0.276	0.135	0.18

The site-specific design response parameters are provided in the following table. These parameters were determined from Design Response Spectra presented in table above, and following guidelines of ASCE Section 21.4.

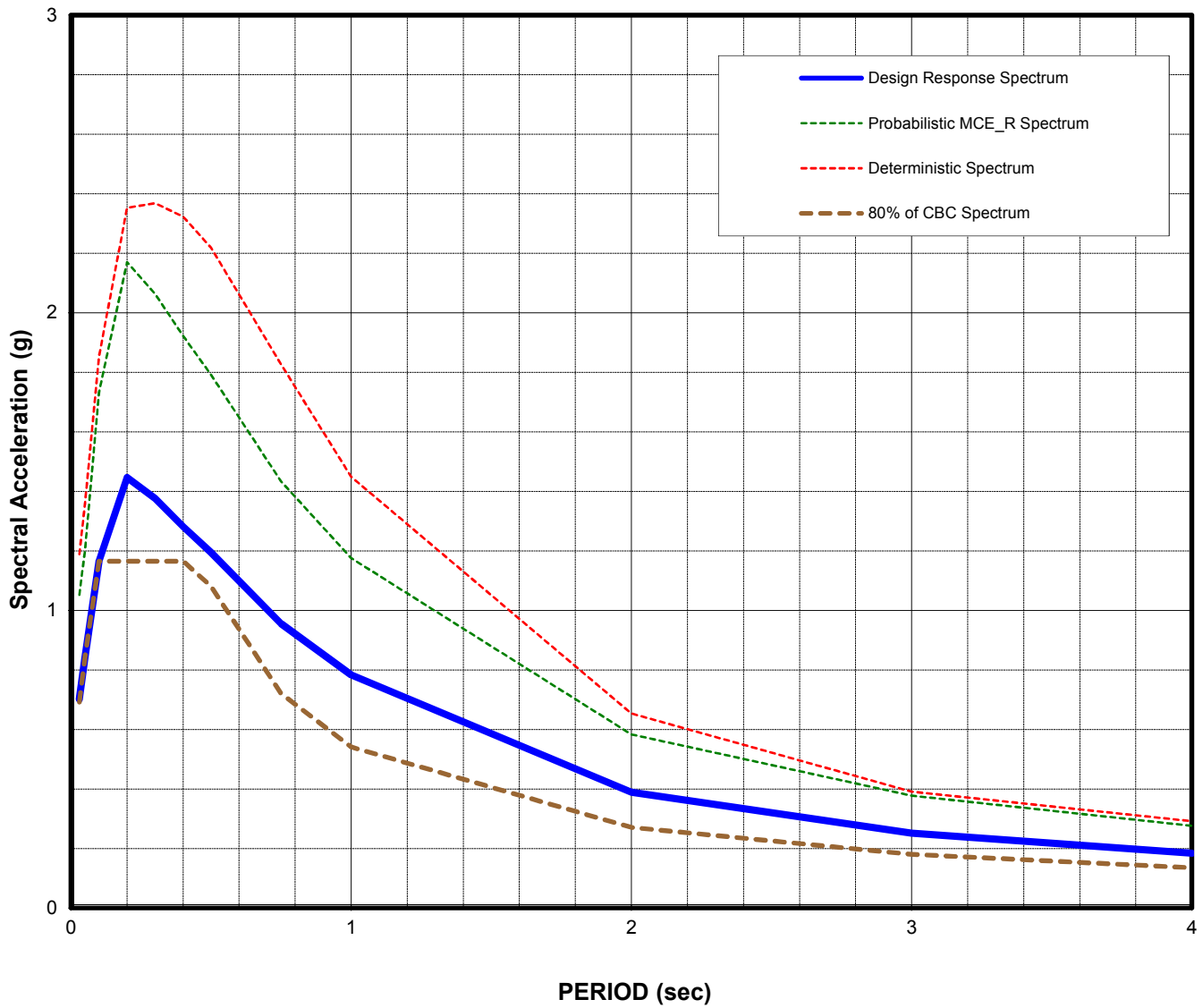

Note: Calculated using EZFRISK program Risk Engineering, version 7.62 and USGS 2008 fault model database.

SITE SPECIFIC DESIGN RESPONSE SPECTRUM

Mt. SAC Transit Center Parking Lot R
 1100 N. Grand Avenue, Walnut, CA 91789
 For : Mt. San Antonio College

Project Number:
 17-31-247-01



Converse Consultants

Drawing No.

11

Table No. 6, Site-Specific Seismic Design Parameters

Parameter	Value (5% Damping)	Lower Limit, 80% of CBC Design Spectra
Site-Specific 0.2-Second Period Spectral Response Acceleration, S_{MS}	2.170	1.748
Site-Specific 1-Second Period Spectral Response Acceleration, S_{M1}	1.175	0.811
Site-Specific Design Spectral Response Acceleration for Short Period, S_{DS}	1.446	1.165
Site-Specific Design Spectral Response Acceleration for 1-Second Period, S_{D1}	0.784	0.541

7.0 GEOTECHNICAL EVALUATIONS AND CONCLUSIONS

Based on the results of our background review, subsurface exploration, laboratory testing, geotechnical analyses, and understanding of the planned site re-development, it is our opinion that the proposed project is feasible from a geotechnical standpoint, provided the following conclusions and recommendations are incorporated into the project plans, specifications, and are followed during site construction.

The following is a summary of the major geologic and geotechnical factors to be considered for the planned project:

- There are no known active faults projecting toward or extending across the proposed site. The project site is not located within a currently designated State of California Earthquake Fault Zone (formerly Alquist-Priolo Special Studies Zones) for surface fault rupture.
- The western and southern portions of the project site along Bonita Drive are underlain by alluvial sediments and are located within a mapped Seismic Hazard Zone for liquefaction. Liquefaction analyses were performed for the upper 50 feet below ground surface utilizing BH-4, BH-6, CPT-9 and BH-11. Based on the results of liquefaction analyses indicate the project site is susceptible to liquefaction. The estimated potential liquefaction induced settlement is on the order of 0.43 to 2.58 inches with potential differential settlement of 0.22 to 1.29 inches.
- Local zones of groundwater seepage and groundwater were encountered during subsurface exploration at depths ranging from approximately 20 feet bgs in Boring BH-6 to approximately 60 feet bgs in Boring BH-3. Groundwater and groundwater seepage should be anticipated during deep excavations.
- Shallow spread and continuous footings are considered suitable for structure support provided the recommendations in this report are incorporated into the project plans, specifications, and are followed during site construction.
- Variable thickness undocumented fill soils were encountered in the borings. The undocumented fill is not considered suitable for any slab or foundation support.
- Based on the proposed plan, cut-and-fill grading operations are required to achieve the planned finished grades.
- Over-excavation and re-compaction of the undocumented fill soils, upper alluvium and top portion of the sedimentary bedrock subgrade is recommended for site grading to provide a compacted fill blanket beneath the building foundations and floor slabs. The over-excavation and re-compaction for the areas underlain by sedimentary bedrock (Tpss) should be over-excavated and recompacted to provide a uniform 5-foot thick

layer of compacted fill beneath the building foundations and floor slab. To mitigate the low to medium expansive potential of the sedimentary bedrock materials (siltstone and claystone) provide a minimum 2-foot thick layer of lime-treated soil or non-expansive, granular compacted fill soils beneath the floor slabs.

- Over-excavation and re-compaction for areas underlain by alluvial soils (Qal) and the edge of the sedimentary bedrock (Tpss) along the west and south sides of the parking structure is recommended to extend 10 feet below plan grade surface, a minimum of 10 feet beyond the edge of the parking structure foundations, and a minimum of 15 feet of overlap over the edge of the sedimentary bedrock (Tpss). A geofabric reinforcement layer (HP570) is recommended on the compacted bottom of the 10-foot depth of over-excavation to reduce differential settlements between the underlying alluvium and shallow sedimentary bedrock materials.
- Different earth materials should be anticipated at the bottom of excavations. In order to provide a relative uniform bearing material below shallow foundations, over-excavation and re-compaction of existing alluvium and bedrock below the bottom of foundations and slab-on-grades are recommended. We recommend the spread foundations and slab-on-grades be supported on a minimum 5-foot thick layer of compacted fill that is be benched into native earth materials.
- On-site clayey soils with an expansion index exceeding 20 should not be re-used for compaction within 2 feet below the proposed foundations or for retaining wall backfill. Soils containing organic materials should not be used as structural fill. The extent of removal should be determined by the geotechnical representative based on soil observation during grading.
- Site soils have “negligible” concentrations of water soluble sulfates.
- In general, the pH value, chloride content, and saturated resistivity of the site soils are in the non-corrosive range. However, the saturated resistivity of samples taken at project site indicate a “Corrosive” potential to ferrous metals.
- The earth materials at the site should be excavatable with conventional heavy-duty earth moving and trenching equipment. The on-site materials may contain about 5 to 10 percent gravel up to 3 inches in maximum dimension. Larger gravels, cobbles and possible boulders may exist at the site. Localized areas of harder, cemented and resistant bedrock units and layers may be encountered in the excavation and should be anticipated. The sedimentary bedrock materials will require excavation, processing and mixing for use as compacted fills. Earthwork should be performed with suitable equipment for gravelly materials and for hard, cemented, bedrock materials.
- The planned structure might have different structure heights and foundation elevations. Differential vertical and lateral deflections between structures should be

anticipated. We recommend cold joints on slabs and walls at the transition between structures or where needed determined by the structural engineer should be constructed.

8.0 EARTHWORK AND SITE GRADING RECOMMENDATIONS

8.1 General Evaluation

Based on our field exploration, laboratory testing, and analyses of subsurface conditions at the site, remedial grading is required to prepare the site for support of the proposed parking structure. The subject site has slight slope to the southwest. It is anticipated that the site preparation will include excavation and removal of the remaining hillside slope to plan Level 1 surface grades and over-excavation and re-compaction of the upper earth materials. To reduce potential differential settlements, variations in the soil and bedrock types, degree of compaction, and thickness of the compacted fill, the thickness of compacted fill placed underneath the footings should be kept uniform where possible. A geofabric reinforcement layer (HP570) is recommended at the bottom of the deeper 10-foot depths of over-excavation in the alluvium and along the edge of the sedimentary bedrock to reduce differential settlements between the underlying alluvium and shallow sedimentary bedrock areas. To mitigate the low to medium expansion potential of the sedimentary bedrock materials and clay soils, we recommend the top 2 feet of prepared subgrade be treated with lime to stabilize the earth materials or replaced with granular, non-expansive soil materials.

Site grading recommendations provided below are based on our experience with similar projects in the area and our evaluation of this investigation.

Site preparation will require removal of remaining hilltop slope and existing pavements, structures, footings, slabs, sidewalks, curbs, trees and other improvements with their foundations and existing underground structures, vaults and utility lines. Top soils containing organic rich materials are not acceptable for reuse as compacted fill soils beneath the parking structure footings and floor slab.

The site soils can be excavated utilizing conventional heavy-duty earth-moving equipment. The excavated site soils, free of vegetation, shrub and debris, may be placed as compacted fill in structural areas after proper processing, mixing and moisture conditioning. The upper undocumented stockpiled fill soils and natural granular soils consisting of silty sands should be segregated, stockpiled and saved during excavation for later reuse beneath the footings and floor slabs to prevent mixing with the underlying fine-grained, potentially expansive, silts and clays. Rocks larger than three (3) inches in the largest dimension should not be placed as fill. Rocks larger than one (1) inch should not be placed within the upper 12 inches of subgrade soils.

On-site clay and silt soils and with an expansion index exceeding 20 should not be re-used for compaction within 2 feet below the proposed foundations, floor slabs or for retaining wall backfill. Soils containing organic materials should not be used as structural fill. The extent of removal should be determined by the geotechnical representative based on soil observations made during grading.

To mitigate potentially expansive earth materials in the upper subgrade materials with lime treatment, we recommend the top 2 feet of the soil and bedrock subgrade be over-excavated, processed, and thoroughly mixed with 4 to 5 percent lime by weight of dry earth material. Thorough mixing will be required to distribute the lime throughout the earth materials and to initially pulverize the earth materials and prepare it for the addition of water to initiate the chemical reaction for stabilization. Rotary mixers should be used to ensure the thorough mixing of the lime, soil and water. It is essential that adequate water be added before final mixing to ensure complete hydration and to bring the soil moisture content 3 percent above optimum before compaction. The rotary mixers will have to mix the materials in multiple lifts depending on equipment capability. Earth materials excavated from the building pads and 10-feet beyond the edge of foundations can be lime-treated in lifts as it is removed and stored in a stockpile for up to several weeks. These treated soils should have a water content 1 to 3 percent above optimum moisture content to ensure that the lime reaction has enough water for completion. This practice saves construction time as the mellowing is occurring in the fill material stockpile. The treated and mellowed fill material can then be compacted in lifts without delay as it is returned to building pad and compacted.



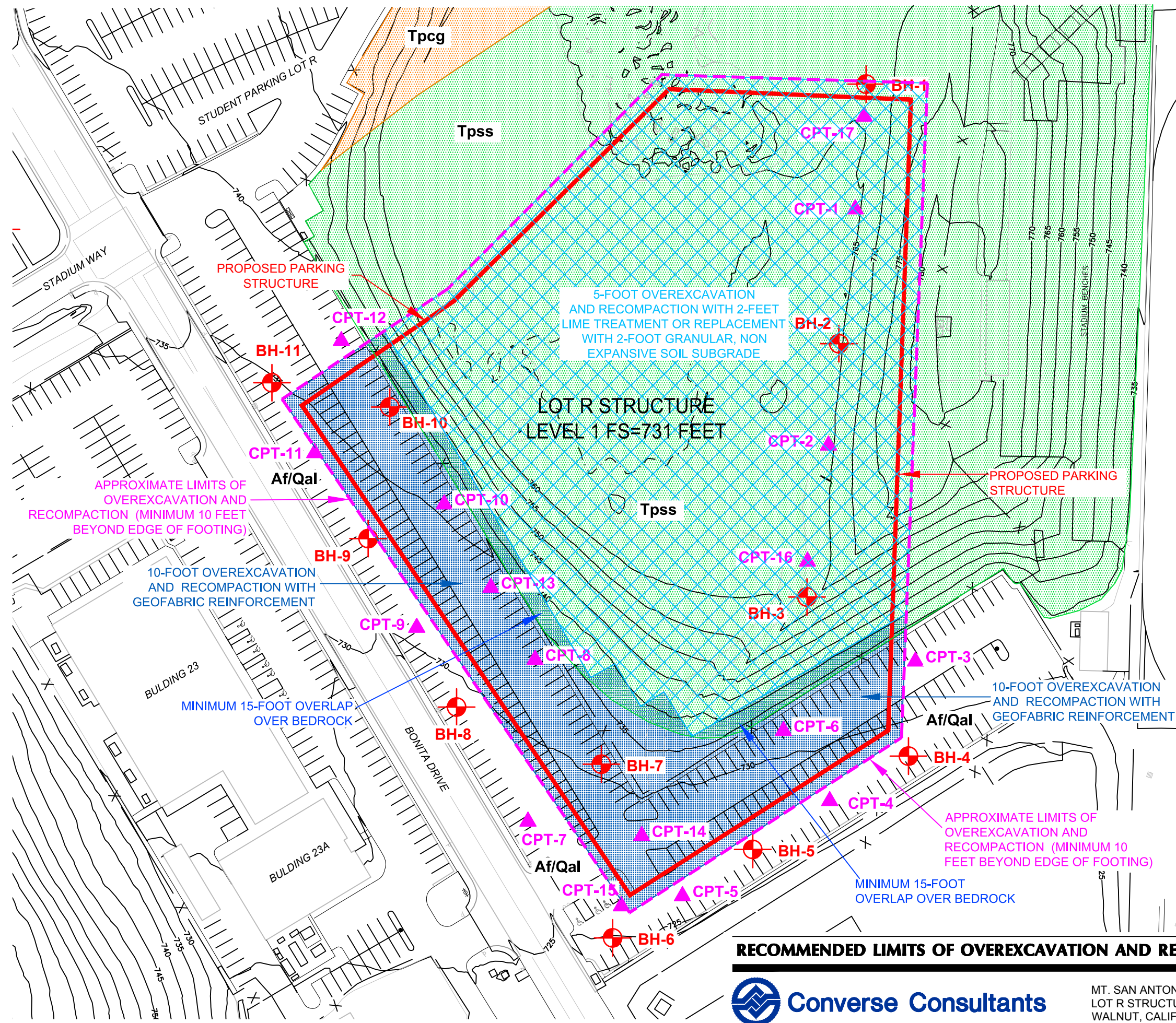

8.2 Over-Excavation/Removal

Over-excavation and re-compaction of the undocumented fill soils, upper alluvium and sedimentary bedrock is recommended for site grading to provide a minimum 5-foot thick layer of compacted fill beneath the bottom of the building foundations and floor slabs. Different earth materials will be encountered at the bottom of the excavations. In order to provide a relative uniform bearing material below parking structure foundations and floor slabs, and reduce differential settlements between the underlying alluvium and shallow sedimentary bedrock earth materials, over-excavation and re-compaction below the foundations and slab-on-grades is recommended. The over-excavation and re-compaction for the areas underlain by sedimentary bedrock (Tpss) should extend approximately 5-feet below plan subgrade to provide a uniform 5-foot thick layer of compacted fill. A minimum 2-foot thick layer of lime-treated soil or non-expansive, granular compacted fill beneath the floor slabs should be used to mitigate the potentially expansive earth materials.

Over-excavation and re-compaction for areas underlain by alluvial soils (Qal) and the edge of the sedimentary bedrock (Tpss) along the west and south sides of the parking structure is recommended to extend 10-feet below plan grade surface, and a minimum 10-feet beyond the edge of the parking structure foundations, and a minimum of 15-feet of overlap over the edge of the sedimentary bedrock (Tpss). A geofabric reinforcement layer (Mirafi HP 570 or equivalent) is recommended at the bottom of the deeper 10-foot depths of over-excavation to reduce potential differential settlements between the underlying alluvium and shallow bedrock areas. Drawing No.12, *Recommended Limits of Over-Excavation and Re-Compaction with Geofabric Reinforcement*, shows the



LEGEND

-  APPROXIMATE LOCATION OF BORING (AUGUST 2017)
-  APPROXIMATE LOCATION OF CPT SOUNDINGS (SEPTEMBER 2017)
-  Tpcg SEDIMENTARY BEDROCK-PUENTE FORMATION PEBBLE CONGLOMERATE AND SANDSTONE, HARD, CEMENTED
-  Tps SEDIMENTARY BEDROCK-PUENTE FORMATION, INTERBEDDED SILTSTONE, CLAYSTONE AND SANDSTONE, LOW TO MEDIUM EXPANSION POTENTIAL.
- Af** FILL SOILS FROM PREVIOUS SITE GRADING
- Qal** ALLUVIAL SOILS

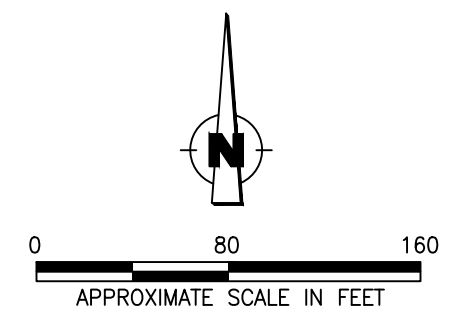

RECOMMENDED LIMITS OF OVEREXCAVATION AND RECOMPACTION WITH GEOFABRIC REINFORCEMENT

approximate limits and depths of over-excavation and re-compaction for the proposed parking structure.

The bottom and edges of the excavations shall be cleaned, squared-off and leveled. If loose, soft, disturbed or otherwise unsuitable soil materials are encountered at the bottom of excavations, deeper removals will be required until firm and unyielding native soils are encountered. The final bottom surfaces and limits of all excavations shall be observed and approved by the project geotechnical engineer or his representative prior to placing compacted fill. The bottoms should be proof rolled with a loaded, heavy, rubber tired piece of grading equipment to identify any remaining loose or soft bottom areas. The bottom of excavation shall be observed, evaluated and approved during grading to determine that suitable firm and unyielding soils have been encountered. The exposed bottom shall then be scarified 6-8 inches in depth, mixed, moisture conditioned or dried back as necessary, and compacted to 90% relative maximum dry density compaction prior to smoothing and leveling for placement of the bottom geosynthetic reinforcement layer.

A geofabric reinforcement layer consisting of Mirafi HP 570 or equivalent, shall be placed across the prepared bottom of the deeper 10-foot depths of over-excavation and minimum 15-foot bedrock bench cut overlap as shown on Drawing No.12, *Recommended Limits of Over-Excavation and Re-Compaction with Geofabric Reinforcement*. The bottom layer of Mirafi HP 570 geotextile reinforcement, or equivalent, shall be laid across the prepared soil subgrade in accordance with the manufacture's recommendations and project specifications. A minimum 1-foot side-to-side overlap should be provided for each fabric layer in accordance with project and manufacturer's specifications. An approximately 2-inch thick layer of moisture conditioned fill should be placed between the overlapping geotextile fabric layers to increase friction resistance between the overlapping sections of geotextile fabric. The installation should be observed and documented by the geotechnical engineer or his designated representative prior to backfill grading. Once placement of the geotextile reinforcement layers have been observed and documented by the geotechnical engineer or his designated representative, moisture conditioned backfill soils can be carefully placed, spread smoothed and level over the geotextile reinforcement layer without disturbing the geotextile layers or their positions. The remaining fill soils should then be placed, mixed, moisture conditioned and compacted to 90% relative compaction in 6-inch to 8-inch lifts and compacted in accordance with project specifications to bring the fill soils up to plan grades.

We recommend a minimum 5 feet of onsite soils and bedrock below the bottom of foundations and floor slabs should be removed, moisture-conditioned if necessary and replaced as compacted fill for parking structure. All undocumented fill should be removed and replaced with compacted fill.

The excavations to remove undocumented fills, alluvium and bedrock to proposed subgrade levels should be extended to ten (10) feet laterally beyond the building limits and appendages where space is available. All loose, soft or disturbed earth materials should be removed from the bottom of excavations before placing structural fill.

Thickness of compacted fill underneath the buildings should not vary significantly. After the required removals have been made, the exposed native earth materials shall be excavated to provide a minimum 5-foot thick zone of structural fill for the support of footings, slabs-on-grade, and exterior flatwork.

For retaining walls, we recommend over-excavation be at least 5 feet below existing grade and 2 feet laterally beyond the foot prints, where space is available.

The exposed bottom of the over-excavation area should be scarified at least 6 inches, moisture conditioned as needed to near-optimum moisture content, and compacted to 90 percent relative compaction. Over-excavation should not undermine adjacent off-site improvements. Remedial grading should not extend within a projected 1:1 (horizontal to vertical) plane projected down from the outer edge of adjacent off-site improvements. If loose, yielding soil conditions are encountered at the excavation bottom, the following options can be considered:

- a. Over-excavate until reach firm bottom.
- b. Scarify or over-excavate additional 18 inches deep, and then place at least 18-inch-thick compacted base material (CAB or equivalent) to bridge the soft bottom. Base should be compacted to 90% relative compaction.
- c. Over-excavate additional 18 inches deep, and then place a layer of geofabric i.e. Mirafi HP570, or equivalent), place 18-inch-thick compacted base material (CAB or equivalent) to bridge the soft bottom. Base should be compacted to 90% relative compaction. An additional layer of geofabric may be needed on top of base depending on the actual site conditions.

The actual depth of removal should be based on recommendations and observation made during grading by the project geotechnical engineer or his designated representative. Therefore, some variations in the depth and lateral extent of over-excavation recommended in this report should be anticipated.

Site grading may result in transition lines with cut and/or fill conditions. This transition line would require special grading considerations. Detailed site grading recommendations are provided in the following sections.

8.3 Structural Fill

The approved bottom of the excavations should be scarified to a depth of at least six (6) inches. The scarified soils should be moisture conditioned and mixed to within three (3) percent of optimum moisture content for granular soils and to approximately three (3) percent above the optimum content to near-optimum moisture content for the fine-grained soils. Scarified soil shall be compacted to a minimum 90 percent of the laboratory maximum dry density as determined by the ASTM Standard D1557 test method to produce a firm and unyielding surface.

All structural fill should be placed on competent, scarified and compacted native materials as determined by a geotechnical engineer or his designated representative and in accordance with the specifications presented in this section.

Excavated site soils, free of deleterious materials and rock fragments larger than three (3) inches in the largest dimension, should be suitable for placement as compacted fill. Any import fill should be tested and approved by Converse. The import fill should have an expansion potential less than 20.

Prior to compaction, fill materials should be thoroughly mixed and moisture conditioned when necessary, within three (3) percent of the optimum moisture for granular soils and at approximately three (3) percent above the optimum moisture for fine-grained soils. All fill, if not specified otherwise elsewhere in this report, should be compacted to at least 90 percent of the laboratory dry density in accordance with the ASTM Standard D1557 test method. The amount of processing required for proper moisture conditioning and mixing at the site will depend on the seasonal variations in the in-situ moisture conditions, the depth of cut, the equipment, weather and the processing method.

Fill exceeding five (5) feet in height shall not be placed on native slopes that are steeper than 5:1 horizontal:vertical (H:V). Where native slopes are steeper than 5:1 H:V, and the height of the fill is greater than five (5) feet, the fill shall be keyed and benched into competent materials. The height and width of the benches shall be at least two (2) feet.

8.4 Excavatability

Based on our field exploration, the earth materials at the site should be excavatable with conventional heavy-duty earth moving and trenching equipment. The onsite materials contain about 5 to 10 percent gravels up to 3 inches in maximum dimension. Larger gravels, cobbles and possible boulders may exist at the site. The deeper sedimentary bedrock materials are less weathered, cemented and moderately hard to hard. The excavation and rippability of these hard bedrock materials will be more difficult and should be anticipated during grading. Many of the soil borings drilled for the project site encountered difficult drilling and/or refusal in the sedimentary bedrock materials beneath the former hillside. Standard Penetration Tests (SPT) blow counts in the sedimentary bedrock materials were high and often times met refusal to sampler penetrations. Localized areas of very hard bedrock requiring single shank ripping or hydraulic breakers should be anticipated. Directional ripping and downsizing breakers may be required in harder and cemented bedrock materials. Earthwork should be performed with suitable equipment for hard and cemented bedrock materials.

8.5 Expansive Soil

Based on our laboratory testing results, the on-site fine-grained silt and clay earth materials are considered to have a low to moderate expansion potential. Medium to high expansion potential in fine-grained silt and clay materials may be anticipated. The on-

site soil materials will be mixed during the grading and the expansion potential might change. Therefore, the expansion potential of site soils should be verified after the grading as slabs, foundations and pavement placed directly on expansive subgrade soil will likely crack over time.

To mitigate the expansive soils, on-site clayey soils with an Expansion Index higher than 20 should not be re-used for compaction within 2 feet below the proposed foundations, floor slabs or for retaining wall backfill. The extent of removal should be determined by the geotechnical representative based on soil observation during grading.

There are several alternative mitigation measures that can be utilized to improve expansive soils at the site. Some mitigation measures include:

- Removing the top two (2) feet of subgrade soils beneath the plan grade surfaces throughout the site, and replacing with imported non-expansive sandy soil materials.
- Reinforce footings and place thicker concrete slabs with moisture barriers.
- Lime treat the upper two (2) feet of the subgrade soils.

8.6 Shrinkage and Subsidence

The shrinkage and/or bulkage would depend on, among other factors, the depth of cut and/or fill, and the grading method and equipment utilized. For preliminary estimation, bulking and shrinkage factors for various units of earth material at the site may be taken as presented below:

- The approximate shrinkage factor for the upper ten (10) feet of alluvial soils is estimated to range from ten (10) to twenty (20) percent.
- Subsidence would depend on the construction methods including type of equipment utilized. For estimation purposes, ground subsidence may be taken as 0.20 feet.

Although these values are only approximate, they represent our best estimates of the factors to be used to calculate lost volume that may occur during grading. If more accurate shrinkage and subsidence factors are needed, it is recommended that field-testing using the actual equipment and grading techniques be conducted.

8.7 Subgrade Preparation

Final subgrade soils for structures and streets should be uniform and non-yielding. To obtain a uniform subgrade, soils should be well mixed and uniformly compacted. The subgrade soils should be non-expansive and well-drained. The near-surface site soils should be free draining. We recommend that at least the upper two (2) inches of subgrade

soils underneath the slab-on-grade should be comprised of well-drained granular soils such as sands, gravel or crushed aggregate satisfying the following criteria:

- Maximum size \leq 0.5 inches
- Percent passing U.S. #200 sieve \leq 12 percent
- Sand equivalent \geq 30

The subgrade soils should be moisture conditioned before placing concrete.

The various design recommendations provided in this section are based on the assumptions that in preparing the site, the earthwork and site grading recommendations provided in this report will be followed. The proposed buildings may be supported by shallow continuous and isolated square footings.

9.0 DESIGN RECOMMENDATIONS

9.1 Shallow Foundations

9.1.1 Vertical Capacity

Continuous and square footings should be founded at least 24 inches below lowest adjacent final grade on the recommended earth materials. A minimum footing width of 24 inches is recommended for continuous and square footings. The net allowable dead plus live load bearing value for isolated square and continuous footings is 2,000 psf. The net allowable bearing pressure can be increased by 200 psf for each additional foot of excavation depth and width up to a maximum value of 4,000 psf.

The net allowable bearing values indicated above are for the dead loads and frequently applied live loads and are obtained by applying a factor of safety of 3.0 to the net ultimate bearing capacity.

9.1.2 Lateral Capacity

Resistance to lateral loads can be provided by friction acting at the base of the foundation and by passive earth pressure. A coefficient of friction of 0.35 may be assumed with normal dead load forces. An allowable passive earth pressure of 200 psf per foot of depth up to a maximum of 2,500 psf may be used for footings poured against properly compacted fill or undisturbed stiff natural soils. The values of coefficient of friction and allowable passive earth pressure include a factor of safety of 1.5.

9.1.3 Settlement

The static settlement of structures supported on continuous and/or spread footings founded on compacted fill will depend on the actual footing dimensions and the imposed vertical loads. Most of the footing settlement at the project site is expected to occur immediately after the application of the load. Based on the maximum allowable net bearing pressures presented above, static settlement is anticipated to be less than 1.0 inch. Differential settlement is expected to be up to one-half of the total settlement over a 30-foot span.

9.1.4 Dynamic Increases

Bearing values indicated above are for total dead load and frequently applied live loads. The above vertical bearing may be increased by 33% for short durations of loading which will include the effect of wind or seismic forces. The allowable passive pressure may be increased by 33% for lateral loading due to wind or seismic forces.

9.2 Modulus of Subgrade Reaction

For the subject project, design of the structures supported on compacted fill subgrade prepared in accordance with the recommendations provided in this report may be based on a soil modulus of subgrade reaction of (k_s) of 150 pounds per square inch per inch.

9.3 Lateral Earth Pressure

The proposed retaining walls are anticipated to be up to 15 feet in height. The earth pressure behind any buried wall depends primarily on the allowable wall movement, type of backfill materials, backfill slopes, wall inclination, surcharges, and any hydrostatic pressure. The following fluid pressures are recommended for vertical walls with no hydrostatic pressure, no surcharge, and level backfill.

Table No. 7, Lateral Earth Pressures for Retaining Wall Design

Wall Type	Equivalent Fluid Pressure (pcf)
	Level Backfill
Cantilever Wall (Active pressure)	35 (Triangular Distribution)
Restrained Wall (At-rest pressure)	55 (Triangular Distribution)

The recommended lateral pressures assume that the walls are fully back-drained with granular, free-draining, non-expansive soil materials to prevent build-up of hydrostatic pressure. Adequate drainage could be provided by means of permeable drainage materials wrapped in filter fabric installed behind the walls. The drainage system should consist of perforated pipe surrounded by free draining, uniformly graded, ¾ -inch washed, permeable aggregate material, and wrapped in filter fabric such as Mirafi 140N or equivalent, and should extend to about 2 feet below the finished grade. The filter fabric should overlap approximately 12 inches or more at the joints. The subdrain pipe should consist of perforated, four-inch diameter, Schedule 40 PVC or rigid ABS (SDR-35), or equivalent, with perforations placed down. Alternatively, a prefabricated drainage composite system such as the Miradrain G100N or equivalent can be used. The subdrain should be connected to surface drain or sump pump. Subterranean walls should be waterproofed to prevent moisture migration and moisture problems.

In addition, walls with inclined backfill should be designed for an additional equivalent fluid pressure of one (1) pound per cubic foot for every two (2) degrees of slope inclination. Walls subjected to surcharge loads located within a distance equal to the height of the wall should be designed for an additional uniform lateral pressure equal to one-third or one-half the anticipated surcharge load for unrestrained or restrained walls, respectively. These values are applicable for backfill placed between the wall stem and an imaginary plane rising 45 degrees from below the edge (heel) of the wall footings.

Cantilever retaining walls greater than 12 feet, as measured from the surface, should be designed to resist additional earth pressure caused by seismic ground shaking. A

dynamic earth pressure of 21H (psf), based on an inverted triangular distribution, can be used for design of wall.

9.4 Slabs-on-Grade

Slabs-on-grade should have a minimum thickness of five inches for support of nominal ground-floor live loads without hydrostatic uplift pressures. Minimum reinforcement for slabs-on-grade should be No. 3 reinforcing bars, spaced at 18 inches on-center each way. The thickness and reinforcement of more heavily-loaded slabs will be dependent upon the anticipated loads and should be designed by a structural engineer.

Slabs should be designed and constructed as promulgated by the American Concrete Institute (ACI) and the Portland Cement Association (PCA). Prior to the slab pour, all utility trenches should be properly backfilled and compacted. Care should be taken during concrete placement to avoid slab curling.

In areas where a moisture-sensitive floor covering (such as vinyl tile or carpet) is used, slabs should be protected by at least a 10-mil-thick moisture barrier between the slab and compacted subgrade that meets the performance criteria of ASTM E 1745 Class A material. Polyethylene sheets should be overlapped a minimum of six inches, and should be taped or otherwise sealed.

9.5 Soil Corrosivity Evaluation

Converse retained the Environmental Geotechnology Laboratory, Inc., located in Arcadia, California, to test one (1) selected soil sample taken in the general area of the proposed structures. The tests included minimum resistivity, pH, soluble sulfates, and chloride content, with the results summarized on the following table:

Table No. 8, Soil Corrosivity Test Results

Boring No.	Sample Depth (feet)	pH (Caltrans 643)	Soluble Chlorides (Caltrans 422) ppm	Soluble Sulfate (Caltrans 417) (%)	Saturated Resistivity (Caltrans 643) Ohm-cm
BH-1	35	7.62	170	0.071	480
BH-10	10	7.78	190	0.095	570

Based on our review of soil corrosivity test results (see Appendix B), the soluble sulfate concentration, pH, and chloride content are not in the corrosive range to concrete in accordance with the Caltrans Corrosive Guidelines (2012). However, the minimum saturated resistivity is in the corrosive range to ferrous metal. Protections of underground metal pipe should be considered. Since the soluble sulfate concentrations tested for this project are less than 2,000 ppm in the soil, mitigation measures to protect concrete in contact with the soils are not anticipated. Type I or II Portland Cement may be used for the construction of the foundations and slabs.

The test results presented herein are considered preliminary. Additional testing and evaluation of the as-graded soils is recommended. A corrosion engineer may be consulted for appropriate mitigation procedures and construction design, if needed. Conventional corrosion mitigation measures may include the following:

- Steel and wire concrete reinforcement should have at least three inches of concrete cover where cast against soil, unformed. Below-grade ferrous metals should be given a high-quality protective coating, such as 18-mil plastic tape, extruded polyethylene, coal-tar enamel, or Portland cement mortar.
- Below-grade metals should be electrically insulated (isolated) from above-grade metals by means of dielectric fittings in ferrous utilities and/or exposed metal structures breaking grade.

9.6 Flexible Pavement

The flexible pavement structural section design recommendations were performed in accordance with the method contained in the *CALTRANS Highway Design Manual*, Chapter 630 without the factor of safety. No specific traffic study was performed to determine the Traffic Index (TI) for the proposed project, therefore a wide range of TI values were evaluated.

Due to various earth materials encountered at the site, flexible pavement structural section recommendations are prepared for both subgrade soils. We recommend that the project structural engineer consider the traffic loading conditions at various locations and select the appropriate pavement sections from the following table:

Table No. 9, Flexible Pavement Structural Sections

Design R-value	Design TI	Asphalt Concrete (AC) Over Aggregate Base (AB) Structural Sections		Full AC Structural Section
		AC (inches)	AB (inches)	AC (inches)
13	4	3.0	4.5	5.0
	5	4.0	6.0	6.5
	6	5.5	7.5	8.0
	7	6.5	9.5	9.5
	8	7.5	11.0	11.0
	10	9.0	14.0	14.5

Base material shall conform to requirements for Crushed Miscellaneous Base (CMB) or equivalent and should be placed in accordance with the requirements of the Standard Specifications for Public Works Construction (SSPWC, latest Edition).

Asphaltic materials should conform to Section 203-1, "Paving Asphalt," of the Standard Specifications for Public Works Construction (SSPWC, latest Edition) and should be placed in accordance with Section 302-5, "Asphalt Concrete Pavement," of the SSPWC, 2012 edition.

Positive drainage should be provided away from all pavement areas to prevent seepage of surface and/or subsurface water into the pavement base and/or subgrade.

9.7 Rigid Pavement

Rigid pavement design recommendations were provided in accordance with the Portland Cement Association's (PCA) Southwest Region Publication P-14, *Portland Cement Concrete Pavement (PCCP) for Light, Medium, and Heavy Traffic*. We recommend that the project structural engineer consider the loading conditions at various locations and select the appropriate pavement sections from the following table:

Table No. 10, Rigid Pavement Structural Sections

Design R-Value	Design Traffic Index (TI)	PCCP Pavement Section (inches)
13	5.0	7.25
	6.0	7.50
	7.0	7.75
	8.0	8.25
	9.0	8.50

The pavement sections presented in the table are based on a minimum 28-day Modulus of Rupture (M-R) of 550 psi and a compressive strength of 3,000 psi. The third point method of testing beams should be used to evaluate modulus of rupture. The concrete mix design should contain a minimum cement content of 5.5 sacks per cubic yard. Recommended maximum and minimum values of slump for pavement concrete are three (3) inches and one (1) inch, respectively.

Transverse contraction joints should not be spaced more than 15 feet and should be cut to a depth of ¼ the thickness of the slab. Longitudinal joints should not be spaced more than 12 feet apart. A longitudinal joint is not necessary in the pavement adjacent to the curb and gutter section.

All outside edges should conform to Section 201 of the Standard Specifications for Public Works Construction (SSPWC, latest edition), and should be constructed in accordance with Section 302-6 of the SSPWC. Pavement subgrade should be prepared in accordance with Section 9.7 of this report.

The PCCP materials should conform to Section 201 of the Specifications for Public Works Construction and should be constructed in accordance with Section 302-6 of the SSPWC.

Positive drainage should be provided away from all pavement areas to prevent seepage of surface and/or subsurface water into the pavement base and/or subgrade.

9.8 Site Drainage

Adequate positive drainage should be provided away from the structures to prevent ponding and to reduce percolation of water into structural backfill. We recommend that the landscape area immediately adjacent to the foundation shall be designed sloped away from the building with a minimum 5% slope gradient for at least 10 feet measured perpendicular to the face of the wall. Impervious surfaces within 10 feet of the building foundation shall be sloped a minimum of 2 percent away from the building per 2016 CBC.

Planters and landscaped areas adjacent to the building perimeter should be designed to minimize water infiltration into the subgrade soils. Gutters and downspouts should be installed on the roof, and runoff should be directed to the storm drain through non-erosive devices. Lower level walkways and open patio areas may require special drainage provisions and sump pumps to provide suitable drainage.

10.0 CONSTRUCTION RECOMMENDATIONS

10.1 General

Site soils should be excavatable using conventional heavy-duty excavating equipment. Temporary sloped excavation is feasible if performed in accordance with the slope ratios provided in Section 10.2, *Temporary Excavations*. Existing utilities should be accurately located and either protected or removed as required. For steeper temporary construction slopes or deeper excavations, shoring should be provided by the contractor as necessary, to protect the workers in the excavation.

10.2 Temporary Excavations

Based on the materials encountered in the exploratory borings, sloped temporary excavations may be constructed according to the slope ratios presented in Table No. 11, *Slope Ratios for Temporary Excavation*. Any loose utility trench backfill or other fill encountered in excavations will be less stable than the native soils. Temporary cuts encountering loose fill or loose dry sand may have to be constructed at a flatter gradient than presented in the following table:

Table No. 11, Slope Ratios for Temporary Excavation

Maximum Depth of Cut (feet)	Maximum Slope Ratio* (horizontal: vertical)
0 – 5	vertical
5 – 10	1:1
10 +	1.5:1

*Slope ratio assumed to be uniform from top to toe of slope.

Surfaces exposed in slope excavations should be kept moist but not saturated to retard raveling and sloughing during construction. Adequate provisions should be made to protect the slopes from erosion during periods of rainfall. Surcharge loads, including construction, should not be placed within five (5) feet of the unsupported trench edge. The above maximum slopes are based on a maximum height of six (6) feet of stockpiled soils placed at least five (5) feet from the trench edge.

For steeper temporary construction slopes or deeper excavations, shoring should be provided by the contractor as necessary, to protect the workers in the excavation.

All applicable requirements of the California Construction and General Industry Safety Orders, the Occupational Safety and Health Act of 1987 and current amendments, and the Construction Safety Act should be met. The soils exposed in cuts should be observed during excavation by the project's geotechnical consultant. If potentially unstable soil conditions are encountered, modifications of slope ratios for temporary cuts may be required.

If the excavation occurs near existing structures, special construction considerations would be required during excavation to protect these existing structures during construction. The proposed excavation should not cause loss of bearing and/or lateral supports of the existing structures.

10.3 Shoring Design

Temporary shoring may be required for the recommended excavation due to space limitations and property line boundaries and because of nearby existing structures or facilities and traffic loading. Temporary shoring may consist of the use of a trench box (where feasible), or conventional soldier piles and lagging. Shoring should ultimately be designed by a qualified structural engineer considering the recommendations below in their final design and others which are applicable.

Drilled excavations for soldier piles may require the use of drilling fluids to prevent caving and to maintain an opened hole for pile installation. Casing may be needed if granular earth material is located behind the existing retaining wall.

10.3.1 Cantilevered Shoring

Cantilevered shoring systems may include soldier piles with lagging to maintain temporary support of vertical wall excavations. Shoring design must consider the support of adjacent underground utilities and/or structures, and should consider the effects of shoring deflection on supported improvements. Due to sandy nature of on-site soils, some caving during the drilling of soldier-pile borings should be anticipated. A soldier pile system will require continuous lagging to control caving and sloughing in the excavation between soldier piles.

Temporary cantilevered shoring should be designed to resist a lateral earth pressure equivalent to a fluid density of 35 pounds per cubic foot (pcf) for non-surcharged condition. This pressure is valid only for shoring retaining level ground. This equivalent fluid pressure is valid only for shoring supporting level ground.

In addition to the lateral earth pressure, surcharge pressures due to miscellaneous loads, such as soil stockpiles, vehicular traffic or construction equipment located adjacent to the shoring, should be included in the design of the shoring. A uniform lateral pressure of 100 psf should be included in the upper 10 feet of the shoring to account for normal vehicular and construction traffic within 10 feet of the trench excavation. Surcharge pressures from the existing structures should be added to the above earth pressures for surcharges within a horizontal distance less than or equal to the wall height. Surcharge coefficients of 50% of any uniform vertical surcharge should be added as a horizontal earth pressure for shoring design. All shoring should be designed and installed in accordance with state and federal safety regulations.

The minimum embedment depth for piles is ten (10) feet from the lowest adjacent grade into firm alluvium, below the bottom of the excavation. Vertical skin friction against soldier piles for may be taken as 300 psf. Fixity may be assumed at two (2) feet below the excavation into firm native alluvium or bedrock. For the design of soldier piles spaced at least 3.0 diameters on-center, the passive resistance of the soils adjacent to the piles may be assumed to be 200 psf per foot of embedment depth. Soldier pile members placed in drilled holes should be properly backfilled with a sand/cement slurry or lean concrete in order to develop the required passive resistance.

Caving soils should be anticipated between the piles. To limit local sloughing, caving soils can be supported by continuous lagging or guniting. The lagging between the soldier piles may consist of pressure-treated wood members or solid steel sheets. In our opinion, steel sheeting is expected to be more expedient than wood lagging to install. Although soldier piles and any bracing used should be designed for the full-anticipated earth pressures and surcharge pressures, the pressures on the lagging are less because of the effect of arching between the soldier piles. Accordingly, the lagging between the piles may be designed for a nominal pressure of up to a maximum of 350 psf. All lumber to be left in the ground should be treated in accordance with Section 204-2 of the "Standard Specifications for Public Works Construction" (Latest Edition).

10.3.2 Tie-Back Shoring

A tie-back soldier-pile shoring system may be used to maintain temporary support of deep vertical walled excavations. Braced or tied-back shoring, retaining a level ground surface, should be designed for a uniform pressure of $25H$ psf, where H is the height of the retained cut in feet.

Surcharge pressures should be added to this earth pressure for surcharges within a distance from the top of the shoring less than or equal to the shoring height. A surcharge coefficient of 50 percent of any uniform vertical surcharge should be added as a horizontal shoring pressure for braced shoring. A uniform lateral pressure of 100 psf should be included in the upper 10 feet of the shoring to account for normal vehicular and construction traffic within 10 feet of the trench excavation.

Tie-Backs

For design of tie-back shoring, it should be assumed that the potential wedge of failure is determined by a plane at 30 degrees from the vertical, through the bottom of the excavation. Tie-back anchors may be installed at angles of 15 to 40 degrees below a horizontal plane. Soil friction values, for estimating the allowable capacity of drilled friction anchors, may be computed using the following equation:

$$q = 40H ; \quad q \leq 500 \text{ pounds-per-square-foot (psf)}$$

where:

H = average depth of anchor below ground surface, shown on
 q = anchor surface area resistance, in psf (excluding tip),

Only the frictional resistance developed beyond the assumed failure plane should be included in the tie-back design for resisting lateral loads. After shoring/tie-back is no longer needed to support the excavation, stress should be carefully released and shoring system including tieback may be able to be left in place.

All shoring and tie-back should be designed by experienced California licensed Civil Engineer and installed by experienced contractors. Shoring/tie-back design should also be reviewed by a geotechnical consultant to verify the soil parameters used in the design are in conformance with geotechnical report.

All applicable requirements of the California Construction and General Industry Safety Orders, the Occupational Safety and Health Act of 1987 and current amendments, and the Construction Safety Act should be met. The soils exposed in cuts should be observed during excavation by a competent person employed by the contractor. If potentially unstable soil conditions are encountered, modifications of slope ratios for temporary cuts may be required.

It is recommended that Converse review plans and specifications for proposed shoring and that a Converse representative observes the installation of shoring. A licensed surveyor should be retained to establish monuments on shoring and the surrounding ground prior to excavation. Such monuments should be monitored for horizontal and vertical movement during construction. Results of the monitoring program should be provided immediately to the project Structural (shoring) Engineer and Converse for review and evaluation. Adjacent building elements should be photo-documented prior to construction.

11.0 PLAN REVIEW AND CONSTRUCTION INSPECTION SERVICES

This report has been prepared to aid in evaluation of the site, to prepare site-grading recommendations, and to assist the civil/structural engineer in the design of the proposed developments. It is recommended that this office be provided the opportunity to provide final site grading and design recommendations once the final grading plan is available.

All site grading and earthwork should be completed under the observation and testing of a qualified geotechnical consultant to verify compliance with the recommendations set forth in this report. All ground surfaces should be examined and approved by the project geotechnical consultant prior to placing any fill and/or structure. All footing excavations should be observed prior to placement of steel and concrete to see that footings are founded on satisfactory compacted soils and that excavations are free of loose, disturbed or deleterious materials.

12.0 CLOSURE

The findings and recommendations of this report were prepared in accordance with generally accepted professional engineering and engineering geologic principles and practice. We make no other warranty, either expressed or implied. Our conclusions and recommendations are based on the results of the field and laboratory investigations, combined with an interpolation and extrapolation of soil conditions between and beyond boring locations. If conditions encountered during construction appear to be different from those shown by the borings, this office should be notified.

Design recommendations given in this report are based on the assumption that the earthwork and site grading recommendations contained in this report are implemented. Additional consultation may be prudent to interpret Converse's findings for contractors, or to possibly refine these recommendations based upon the review of the final site grading and actual site conditions encountered during construction. If the scope of the project changes, if project completion is to be delayed, or if the report is to be used for another purpose, this office should be consulted.

13.0 REFERENCES

- AMERICAN SOCIETY OF CIVIL ENGINEERS, ASCE/SEI 7-10, *Minimum Design Loads for Structures and Other Structures*, copyright 2013.
- ASTM INTERNATIONAL, Annual Book of ASTM Standards, Current.
- BLAKE, T. F., 2000, UBCSEIS, FRISKSP *Computer Program for Performing Deterministic, Probabilistic, and Seismic Coefficient Analysis*.
- BLAKE, T.F., 2002 CGS Fault Model, *Computer Model Files, CGS Source Data, Maps for Performing Probabilistic Seismic Hazard Analysis*, copyright 2004, Thomas F. Blake, August 2004.
- BOORE, D.M., JOYNER, W.B. and FUMAL, T.E., 1997, *Empirical near-source attenuation relationships for horizontal and vertical components of peak ground acceleration, peak ground velocity, and pseudo-absolute acceleration response spectra*, Seismological Research Letters, v. 68, p. 154-179.
- BOZORGNIA, Y., CAMPBELL, K.W., and NIAZI, M., *Vertical ground motion: Characteristics relationship with horizontal component, and building code implications*, Proceedings of the SMIP99 Seminar on Utilization of Strong-Motion Data, 1999, Oakland, California, p. 23 - 49.
- BOWLES, J. E., 1982, *Foundation Analysis and Design*, McGraw-Hill, Inc.
- CALIFORNIA BUILDING STANDARDS COMMISSION, 2013, *California Building Code (CBC)*, California Code of Regulations Title 24, Part 2, Volumes 1 and 2.
- CALIFORNIA DEPARTMENT OF CONSERVATION, DIVISION OF MINES AND GEOLOGY, *Seismic Hazard Evaluation of the San Dimas 7.5-Minute Quadrangle, Los Angeles County*, Report 032, 1998.
- CALIFORNIA DIVISION OF MINES AND GEOLOGY, *Fault-Rupture Hazard Zones in California, Alquist-Priolo Earthquake Faulting Zoning Act with Index to Earthquake Fault Zone Maps*, Special Publication 42, Revised 1997, Supplements 1 and 2 added 1999.
- CALIFORNIA DIVISION OF MINES AND GEOLOGY, *Guidelines for Evaluating and Mitigating Seismic Hazards in California*, Special Publication 117, 2008.
- CALIFORNIA GEOLOGIC SURVEY, 1999, *Earthquake Zones of Required Investigation, San Dimas Quadrangle, Seismic Hazard Zones*, Official Map released March 25, 1999.

CALIFORNIA GEOLOGIC SURVEY, 2004, Engineering Geology and Seismology for Public Schools and Hospitals in California, by Robert H. Sydnor, Senior Engineering Geologist, July 1, 2004, 227 pages.

CALIFORNIA GEOLOGIC SURVEY, 2003, 2002 California Fault Parameters – Transverse Ranges and Los Angeles Basin, www.consrv.ca.gov/cgs/rghm/psha/fault.

CALIFORNIA GEOLOGICAL SURVEY, *Fault-Rupture Hazard Zones in California, Alquist-Priolo Earthquake Faulting Zoning Act with Index to Earthquake Fault Zone Maps, Special Publication 42*, Interim Revision 2011.

CALIFORNIA GEOLOGICAL SURVEY, *Alquist-Priolo Earthquake Fault Zone Maps*, for City of Walnut, Los Angeles County, CA. State of California, Department of Conservation. January 17, 2011. http://www.quake.ca.gov/gmaps/ap/ap_maps.htm

CALIFORNIA GEOLOGICAL SURVEY – NOTE 48, Checklist for the Review of Engineering Geology and Seismology Reports for California Public Schools, Hospitals, and Essential Services Buildings, October 2013.

CALIFORNIA GEOLOGIC SURVEY, Third Engineering Geology and Seismology Review for Mt. San Antonio College-Stadium Upgrades, 1100 North Grand Avenue, Walnut, CA, 91789, CGS Application No.03-CGS1876, dated April 25, 2016.

CALIFORNIA GEOLOGIC SURVEY, Fourth Engineering Geology and Seismology Review for Mt. San Antonio College-Stadium Upgrades, 1100 North Grand Avenue, Walnut, CA, 91789, CGS Application No.03-CGS1876, dated May 20, 2016.

CAO, TIANQING, et. al., 2003, The Revised 2002 California Probabilistic Seismic Hazard Maps, June 2003, pp. 1-11, Appendix A.

CIVILTECH SOFTWARE, LiquefyPro, Version 5.8d, 2009, A Computer Program for Computation of Liquefaction and Seismic Settlements.

CONVERSE CONSULTANTS, 2007, Geologic Evaluation of Undeveloped Hillside for Future Grading and Borrow Site, Hillside Between Student Parking Lot R and West Side of Stadium Grandstand, Mt. San Antonio College, Walnut, California, Converse Project No. 07-31-122-01, dated July 23, 2007.

CONVERSE CONSULTANTS, 2011, Geoseismic/Geotechnical Study Report, Proposed Parking Structure Project, Corner of Mountaineer Road and Edinger Road, Mt. San Antonio College, Walnut, California, Converse Project No.10-31-360-01, dated April 15, 2011.

CONVERSE CONSULTANTS, 2013, Geotechnical Study Report, Proposed Fill Placement for the Driving Range and Practice Field and Hilltop Removal for the Future Physical Education Complex, Mt. San Antonio College, Walnut, California, Converse Project No. 13-31-116-01, dated May 23, 2013.

CONVERSE CONSULTANTS, 2015, Geotechnical Study Report, Proposed Athletic Complex East (Telecommunications Building D), Mount San Antonio College, Walnut, California, Converse Project No.14-31-124-02, dated July 31, 2015.

CONVERSE CONSULTANTS, 2016, Updated Geotechnical Study Report, Proposed Athletic Complex East, Mt. San Antonio College, Walnut, California: Converse Project No. 14-31-124-03, dated March 14, 2016.

DEPARTMENT OF THE NAVY, Naval Facilities Engineering Command, Alexandria, VA, *SOIL MECHANICS DESIGN MANUAL 7.1 (NAVFAC DM-7.1)*, 1982.

DIBBLEE, T.W. and Minch, J.A., 2002, Geologic map of the San Dimas and Ontario Quadrangles, Los Angeles and San Bernardino Counties, California: Dibblee Geological Foundation DF-91, scale 1:24,000.

DOLAN, J.F., et. al., 2003, Recognition of Paleo Earthquakes on the Puente Hills Blind Thrust Fault, California, April 4, 2003, *Science*, Vol. 300, pp. 115-118.

FEDERAL EMERGENCY MANAGEMENT AGENCY (FEMA), U.S. Department of Homeland Security, 2008, Flood Insurance Rate Map (FIRM) Panel 1725 of 2350, Map No. 06037C1725F. Online October 17, 2017. <http://msc.fema.gov>

GLOBAL GEO ENGINEERING, INC., “*Geotechnical Investigation Report, Proposed Science Building, Project No. 15-62100-72710000-0818, Mount San Antonio College, Walnut, California*”, dated January 15, 2002.

GLOBAL GEO ENGINEERING, INC., “Response to Engineering Geology and Seismology Review Comments, Proposed Music Center Expansion Project, *Mount San Antonio College, Walnut, California*, dated October 12, 2004.

JENNINGS, CHARLES W. 1994. “Fault Activity Map of California and Adjacent Areas with Location and Ages of Recent Volcanic Eruptions.” *California Geologic Data Map Series*, Map No. 6. California Division of Mines and Geology.

NATIONAL CENTER FOR EARTHQUAKE ENGINEERING RESEARCH (NCEER), Proceedings of the NCEER Workshop on Evaluation of Liquefaction Resistance of Soils, Edited by T.L. Youd and I.M. Idriss, Technical Report NCEER-97-0022, 1997.

- RUBIN, C. M., et. al, 1998, Evidence for Large Earthquakes in Metropolitan Los Angeles, AAAS Science, vol. 281, p. 398-402.
- RUBIN, C. M., et. al., 1998, Evidence for Large Earthquakes in Metropolitan Los Angeles, July 17, 1998, Science, Vol. 281, pp. 398-402.
- SOUTHERN CALIFORNIA EARTHQUAKE CENTER, *Recommended Procedures for Implementation of DMG Special Publication 117 Guidelines for Analyzing and Mitigating Liquefaction in California*, March 1999.
- STANDARD SPECIFICATIONS FOR PUBLIC WORKS CONSTRUCTION, 2012, Public Works Standards, Inc.
- STUDIES IN GEOPHYSICS, 1986, Active Tectonics, Geophysics Study Committee, National Academy Press.
- TOPPOZADA, T., et. al., 2000, Epicenters of and Areas Damaged by $M \geq 5$ California Earthquakes, 1800-1999, Map Sheet 49, California Geologic Survey.
- YEATS, ROBERT S., 2004, Tectonics of the San Gabriel Basin and Surroundings, Southern California, GSA Bulletin, September / October 2004, v. 116, no. 9/10, p. 1158-1182.
- ZIONY, J.I., EDITOR, 1985, Evaluating Earthquake Hazards in the Los Angeles Region – An Earth – Science Perspective, USGS Professional Paper 1360.

Appendix A

Field Exploration

APPENDIX A: FIELD EXPLORATION

Our field investigation included a site reconnaissance of the site and a subsurface exploration program consisting of drilling soil borings and performing Cone Penetration Test (CPT) soundings. During the site reconnaissance on August 14 to August 18, 2017, the surface conditions were noted and the locations of the borings were determined. The borings were located using existing boundary features as a guide and should be considered accurate only to the degree implied by the method used.

Eleven (11) borings (BH-1 through BH-11) were drilled from August 18 to August 24, 2017, extending between depths of approximately 30 to 80 feet below the existing ground surface (bgs). The borings were advanced using a truck mounted drill rig with an 8-inch diameter hollow stem auger for soil sampling. Soils and bedrock were logged by a Converse engineer and classified in the field by visual examination in accordance with the Unified Soil Classification System. The field descriptions have been modified where appropriate to reflect the laboratory test results.

Ring samples of the subsurface materials were obtained at frequent intervals in the exploratory borings using a drive sampler (2.4-inches inside diameter and 3.0-inches outside diameter) lined with sample rings. The steel ring sampler was driven into the bottom of the borehole with successive drops of a 140-pound driving weight falling 30 inches, using an automatic hammer. Samples were retained in brass rings (2.4-inches inside diameter and 1.0-inch in height). The central portion of the sample was retained and carefully sealed in waterproof plastic containers for shipment to the Converse laboratory. Blow counts for each sample interval are presented on the logs of borings. Bulk samples of typical soil types were also obtained.

Standard Penetration Tests (SPT) were also performed using a standard (1.4-inches inside diameter and 2.0-inches outside diameter) split-barrel sampler. The mechanically driven hammer for the SPT sampler was 140 pounds, falling 30 inches for each blow. The recorded blow counts for every six inches for a total of 1.5 feet of sampler penetration are shown on the Logs of Borings in the "BLOWS" column. The standard penetration test was performed in accordance with the ASTM Standard D1586 test method. The soil retrieved from the spoon sampler was carefully sealed in waterproof plastic containers for shipment to the laboratory.

It should be noted that the exact depths at which material changes occur cannot always be established accurately. Changes in material conditions that occur between driven samples are indicated in the logs at the top of the next drive sample. A key to soil symbols and terms is presented as Drawing No. A-1, *Soil Classification Chart*. The logs of the exploratory boring are presented in Drawing Nos. A-2a through A-12b, *Log of Borings*.

The cone penetration testing (CPT) conducted for this project consisted of pushing an instrumented Vertek cone-tipped probe into the ground while simultaneously recording

the resistance to penetration at the cone tip and along the friction sleeve. The cone penetration testing described in this report was conducted in general accordance with the current ASTM specifications (ASTM D5778-95 and D3441-94) using an electronic cone penetrometer.

Seventeen (17) Cone Penetration Test soundings (CPT-1 through CPT-17) were advanced to depths of 25 to 75 feet below ground surface within the project site on September 6 and 7th, 2017 by Kehoe Testing and Engineering using a 30-ton (4 axle) CPT rig. The test holes were stopped at plan depths or when the cone tip encountered refusal to penetration. CPT Nos. CPT-1, CPT-2, CPT-5, CPT-7, and CPT-17 encountered very dense/stiff soil and sedimentary bedrock conditions, and were stopped short of their planned depths. The test holes were then backfilled with bentonite crumbles, periodically hydrated with clean water and tamped. The top portion of the test hole was then patched with asphalt patch and tamped to match existing pavement surfaces.

The Cone Penetration Test (CPT) test logs are presented at the end of Appendix A.

Additional soil borings were drilled and sampled for the project site area during previous geotechnical studies by Converse in 2007, 2013, 2015, and 2016 for the proposed Athletic Complex East and can be provided upon request.

SOIL CLASSIFICATION CHART

MAJOR DIVISIONS			SYMBOLS		TYPICAL DESCRIPTIONS
			GRAPH	LETTER	
COARSE GRAINED SOILS <small>MORE THAN 50% OF MATERIAL IS LARGER THAN NO. 200 SIEVE SIZE</small>	GRAVEL AND GRAVELLY SOILS <small>MORE THAN 50% OF COARSE FRACTION RETAINED ON NO. 4 SIEVE</small>	CLEAN GRAVELS <small>(LITTLE OR NO FINES)</small>		GW	WELL-GRADED GRAVELS, GRAVEL - SAND MIXTURES, LITTLE OR NO FINES
		GRAVELS WITH FINES <small>(APPRECIABLE AMOUNT OF FINES)</small>		GP	POORLY-GRADED GRAVELS, GRAVEL - SAND MIXTURES, LITTLE OR NO FINES
		CLEAN SANDS <small>(LITTLE OR NO FINES)</small>		SW	WELL-GRADED SANDS, GRAVELLY SANDS, LITTLE OR NO FINES
		SANDS WITH FINES <small>(APPRECIABLE AMOUNT OF FINES)</small>		SP	POORLY-GRADED SANDS, GRAVELLY SAND, LITTLE OR NO FINES
	SAND AND SANDY SOILS <small>MORE THAN 50% OF COARSE FRACTION PASSING ON NO. 4 SIEVE</small>	SANDS WITH FINES <small>(APPRECIABLE AMOUNT OF FINES)</small>		SM	SILTY SANDS, SAND - SILT MIXTURES
		CLAYEY SANDS <small>(APPRECIABLE AMOUNT OF FINES)</small>		SC	CLAYEY SANDS, SAND - CLAY MIXTURES
	FINE GRAINED SOILS <small>MORE THAN 50% OF MATERIAL IS SMALLER THAN NO. 200 SIEVE SIZE</small>	SILTS AND CLAYS <small>LIQUID LIMIT LESS THAN 50</small>		ML	INORGANIC SILTS AND VERY FINE SANDS, ROCK FLOUR, SILTY OR CLAYEY FINE SANDS OR CLAYEY SILTS WITH SLIGHT PLASTICITY
				CL	INORGANIC CLAYS OF LOW TO MEDIUM PLASTICITY, GRAVELLY CLAYS, SANDY CLAYS, SILTY CLAYS, LEAN CLAYS
				OL	ORGANIC SILTS AND ORGANIC SILTY CLAYS OF LOW PLASTICITY
		SILTS AND CLAYS <small>LIQUID LIMIT GREATER THAN 50</small>		MH	INORGANIC SILTS, MICACEOUS OR DIATOMACEOUS FINE SAND OR SILTY SOILS
			CH	INORGANIC CLAYS OF HIGH PLASTICITY	
			OH	ORGANIC CLAYS OF MEDIUM TO HIGH PLASTICITY, ORGANIC SILTS	
HIGHLY ORGANIC SOILS				PT	PEAT, HUMUS, SWAMP SOILS WITH HIGH ORGANIC CONTENTS

NOTE: DUAL SYMBOLS ARE USED TO INDICATE BORDERLINE SOIL CLASSIFICATIONS

SAMPLE TYPE

- STANDARD PENETRATION TEST**
Split barrel sampler in accordance with ASTM D-1586-84 Standard Test Method
- DRIVE SAMPLE** 2.42" I.D. sampler.
- DRIVE SAMPLE** No recovery
- BULK SAMPLE**
- GRAB SAMPLE**
- GROUNDWATER WHILE DRILLING**
- GROUNDWATER AFTER DRILLING**

BORING LOG SYMBOLS

LABORATORY TESTING ABBREVIATIONS		
TEST TYPE	STRENGTH	
(Results shown in Appendix B)	Pocket Penetrometer	p
	Direct Shear	ds
	Direct Shear (single point)	ds*
	Unconfined Compression	uc
	Triaxial Compression	tx
	Vane Shear	vs
CLASSIFICATION		
Plasticity	pi	
Grain Size Analysis	ma	
Passing No. 200 Sieve	wa	
Sand Equivalent	se	
Expansion Index	ei	
Compaction Curve	max	
Hydrometer	h	
	Consolidation	c
	Collapse Test	col
	Resistance (R) Value	r
	Chemical Analysis	ca
	Electrical Resistivity	er

UNIFIED SOIL CLASSIFICATION AND KEY TO BORING LOG SYMBOLS



Converse Consultants

Project Name
**MT. SAN ANTONIO COLLEGE
 LOT R PARKING STRUCTURE
 WALNUT, CALIFORNIA**

Project No.
17-31-247-01

Figure No.
A-1

Log of Boring No. BH- 1

Dates Drilled: 8/18/2017 Logged by: RAM Checked By: MBS

Equipment: 8" HOLLOW STEM AUGER Driving Weight and Drop: 140 lbs / 30 in

Ground Surface Elevation (ft): 765.5 Depth to Water (ft): NOT ENCOUNTERED

Depth (ft)	Graphic Log	SUMMARY OF SUBSURFACE CONDITIONS <small>This log is part of the report prepared by Converse for this project and should be read together with the report. This summary applies only at the location of the boring and at the time of drilling. Subsurface conditions may differ at other locations and may change at this location with the passage of time. The data presented is a simplification of actual conditions encountered.</small>	SAMPLES		BLOWS/6"	MOISTURE (%)	DRY UNIT WT. (pcf)	OTHER
			DRIVE	BULK				
5		BEDROCK-PUENTE FORMATION (Tpss): CLAYSTONE AND SILTSTONE: interbedded, moderately weathered, thinly bedded, low hardness, claystone and diatomaceous layers, brown to olive gray,			7/22/27	17	92	
10								
15								
20		SILTSTONE: interbedded layers, some claystone and sandstone layers, diatomaceous layers, moderately weathered, olive	X		5/9/13			
25								
30								13/50(5")



Converse Consultants

Project Name
 MT. SAN ANTONIO COLLEGE
 LOT R PARKING STRUCTURE
 WALNUT, CALIFORNIA

Project No.
 17-31-247-01

Figure No.
 A-2a

Log of Boring No. BH- 1

Dates Drilled: 8/18/2017 Logged by: RAM Checked By: MBS

Equipment: 8" HOLLOW STEM AUGER Driving Weight and Drop: 140 lbs / 30 in

Ground Surface Elevation (ft): 765.5 Depth to Water (ft): NOT ENCOUNTERED

Depth (ft)	Graphic Log	SUMMARY OF SUBSURFACE CONDITIONS <small>This log is part of the report prepared by Converse for this project and should be read together with the report. This summary applies only at the location of the boring and at the time of drilling. Subsurface conditions may differ at other locations and may change at this location with the passage of time. The data presented is a simplification of actual conditions encountered.</small>	SAMPLES		BLOWS/6"	MOISTURE (%)	DRY UNIT WT. (pcf)	OTHER
			DRIVE	BULK				
40		BEDROCK-PUENTE FORMATION (Tpss): CLAYSTONE AND SILTSTONE: interbedded, moderately weathered, thinly bedded, low hardness, diatomaceous layers, black to olive gray	X		13/27/40			
45		-interbedded layers, becoming less weathered with depth, dark gray to black -interbedded layers, dark gray to black, becoming less weathered with depth	X		12/19/24			
50			X		20/50(4")	29	79	
55			X		10/19/22			
60			X		11/50(6")	30	93	
65			X		20/45/45			



Converse Consultants

Project Name
 MT. SAN ANTONIO COLLEGE
 LOT R PARKING STRUCTURE
 WALNUT, CALIFORNIA

Project No.
 17-31-247-01

Figure No.
 A-2b

Log of Boring No. BH- 1

Dates Drilled: 8/18/2017 Logged by: RAM Checked By: MBS

Equipment: 8" HOLLOW STEM AUGER Driving Weight and Drop: 140 lbs / 30 in

Ground Surface Elevation (ft): 765.5 Depth to Water (ft): NOT ENCOUNTERED

Depth (ft)	Graphic Log	SUMMARY OF SUBSURFACE CONDITIONS <small>This log is part of the report prepared by Converse for this project and should be read together with the report. This summary applies only at the location of the boring and at the time of drilling. Subsurface conditions may differ at other locations and may change at this location with the passage of time. The data presented is a simplification of actual conditions encountered.</small>	SAMPLES		BLOWS/6"	MOISTURE (%)	DRY UNIT WT. (pcf)	OTHER
			DRIVE	BULK				
75	[Hatched Pattern]	BEDROCK-PUENTE FORMATION (Tpss): SILTSTONE AND CLAYSTONE: interbedded, thinly bedded, less weathered, low hardness, dark gray	[Solid Black]	[Empty]	12/50(6")	28	96	
80	[Hatched Pattern]		[X]	[Empty]	10/25/50			
			[Solid Black]	[Empty]	22/50(3")	28	91	
		End of boring at 81 feet. Groundwater not encountered during drilling. Borehole backfilled with soil cuttings and tamped on 8-18-17.						



Converse Consultants

Project Name
 MT. SAN ANTONIO COLLEGE
 LOT R PARKING STRUCTURE
 WALNUT, CALIFORNIA

Project No.
 17-31-247-01

Figure No.
 A-2c

Log of Boring No. BH- 2

Dates Drilled: 8/22/2017 Logged by: DA Checked By: MBS

Equipment: 8" HOLLOW STEM AUGER Driving Weight and Drop: 140 lbs / 30 in

Ground Surface Elevation (ft): 764.5 Depth to Water (ft): NOT ENCOUNTERED

Depth (ft)	Graphic Log	SUMMARY OF SUBSURFACE CONDITIONS <small>This log is part of the report prepared by Converse for this project and should be read together with the report. This summary applies only at the location of the boring and at the time of drilling. Subsurface conditions may differ at other locations and may change at this location with the passage of time. The data presented is a simplification of actual conditions encountered.</small>	SAMPLES		BLOWS/6"	MOISTURE (%)	DRY UNIT WT. (pcf)	OTHER
			DRIVE	BULK				
5		<p>BEDROCK - PUENTE FORMATION (Tpss): SILTSTONE AND SANDSTONE: interbedded, moderately weathered, thinly bedded, low hardness, diatomaceous and claystone layers, brown to grayish brown</p>	█		10/27/49			pi
10			█					
15			█					
20			█					
25		<p>SILTSTONE: thinly bedded, some sandstone and claystone layers, low hardness, moderately weathered, grayish brown to gray</p>	█		9/14/33			
30			█		9/31/50			



Converse Consultants

Project Name
 MT. SAN ANTONIO COLLEGE
 LOT R PARKING STRUCTURE
 WALNUT, CALIFORNIA

Project No.
 17-31-247-01

Figure No.
 A-3a

Log of Boring No. BH- 2

Dates Drilled: 8/22/2017 Logged by: DA Checked By: MBS

Equipment: 8" HOLLOW STEM AUGER Driving Weight and Drop: 140 lbs / 30 in

Ground Surface Elevation (ft): 764.5 Depth to Water (ft): NOT ENCOUNTERED

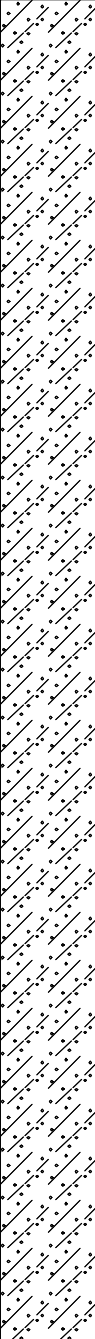
Depth (ft)	Graphic Log	SUMMARY OF SUBSURFACE CONDITIONS <small>This log is part of the report prepared by Converse for this project and should be read together with the report. This summary applies only at the location of the boring and at the time of drilling. Subsurface conditions may differ at other locations and may change at this location with the passage of time. The data presented is a simplification of actual conditions encountered.</small>	SAMPLES		BLOWS/6"	MOISTURE (%)	DRY UNIT WT. (pcf)	OTHER
			DRIVE	BULK				
		BEDROCK - PUENTE FORMATION (Tpss): SILTSTONE AND SANDSTONE: interbedded, thinly bedded, low hardness, diatomaceous layers	■		7/22/43			pi
40		-siltstone with interbedded sandstone layers	■		11/28/50(5")	12	114	ds
45			■		8/21/35			
50			■		35/50(4")			
55		-dark gray to black, becoming less weathered with depth	⊗		7/14/22			
60			■		21/50(5")			
65			⊗		13/50(6")			



Converse Consultants

Project Name
MT. SAN ANTONIO COLLEGE
LOT R PARKING STRUCTURE
WALNUT, CALIFORNIA

Project No.
17-31-247-01

Figure No.
A-3b

Log of Boring No. BH- 2

Dates Drilled: 8/22/2017 Logged by: DA Checked By: MBS

Equipment: 8" HOLLOW STEM AUGER Driving Weight and Drop: 140 lbs / 30 in

Ground Surface Elevation (ft): 764.5 Depth to Water (ft): NOT ENCOUNTERED

Depth (ft)	Graphic Log	SUMMARY OF SUBSURFACE CONDITIONS This log is part of the report prepared by Converse for this project and should be read together with the report. This summary applies only at the location of the boring and at the time of drilling. Subsurface conditions may differ at other locations and may change at this location with the passage of time. The data presented is a simplification of actual conditions encountered.	SAMPLES		BLOWS/6"	MOISTURE (%)	DRY UNIT WT. (pcf)	OTHER
			DRIVE	BULK				
75		BEDROCK - PUENTE FORMATION (Tpss): SILTSTONE AND SANDSTONE: interbedded, thinly bedded, some claystone and diatomeceous layers, dark gray to black			30/50(5")			
80		End of boring at 80.9 feet. Groundwater not encountered during drilling. Borehole backfilled with soil cuttings and tamped on 8-22-17.			25/35/50(5")			
					33/50(5")			



Converse Consultants

Project Name
 MT. SAN ANTONIO COLLEGE
 LOT R PARKING STRUCTURE
 WALNUT, CALIFORNIA

Project No.
 17-31-247-01

Figure No.
 A-3c

Log of Boring No. BH- 3

Dates Drilled: 8/22/2017 Logged by: DA Checked By: MBS

Equipment: 8" HOLLOW STEM AUGER Driving Weight and Drop: 140 lbs / 30 in

Ground Surface Elevation (ft): 760 Depth to Water (ft): 60

Depth (ft)	Graphic Log	<p style="text-align: center;">SUMMARY OF SUBSURFACE CONDITIONS</p> <p style="font-size: small;">This log is part of the report prepared by Converse for this project and should be read together with the report. This summary applies only at the location of the boring and at the time of drilling. Subsurface conditions may differ at other locations and may change at this location with the passage of time. The data presented is a simplification of actual conditions encountered.</p>	SAMPLES		BLOWS/6"	MOISTURE (%)	DRY UNIT WT. (pcf)	OTHER
			DRIVE	BULK				
5		<p>BEDROCK - PUENTE FORMATION (Tpss):</p> <p>SILTSTONE, SANDSTONE AND CLAYSTONE: interbedded, thinly bedded, moderately weathered, thinly bedded, moderately weathered, low hardness, diatomaceous layers, brown to grayish brown</p>						
10					10/26/45	24	85	
15						27	85	
20		-siltstone with interbedded sandstone layers, brown to grayish brown			10/50(6")			
25					50(2")			
30					36/50(3")			



Converse Consultants

Project Name
 MT. SAN ANTONIO COLLEGE
 LOT R PARKING STRUCTURE
 WALNUT, CALIFORNIA

Project No.
 17-31-247-01

Figure No.
 A-4a

Log of Boring No. BH- 3

Dates Drilled: 8/22/2017 Logged by: DA Checked By: MBS

Equipment: 8" HOLLOW STEM AUGER Driving Weight and Drop: 140 lbs / 30 in

Ground Surface Elevation (ft): 760 Depth to Water (ft): 60

Depth (ft)	Graphic Log	SUMMARY OF SUBSURFACE CONDITIONS <small>This log is part of the report prepared by Converse for this project and should be read together with the report. This summary applies only at the location of the boring and at the time of drilling. Subsurface conditions may differ at other locations and may change at this location with the passage of time. The data presented is a simplification of actual conditions encountered.</small>	SAMPLES		BLOWS/6"	MOISTURE (%)	DRY UNIT WT. (pcf)	OTHER
			DRIVE	BULK				
		BEDROCK - PUENTE FORMATION (Tpss): SILTSTONE AND SANDSTONE: interbedded, thinly bedded, moderately weathered, low hardness, claystone and diatomaceous layers, brown to grayish brown	■		31/50(5")			
40			■		30/44/50(4")	12	109	c
45			■		13/50(4")	23	90	
50			⊗		9/50/32			
55			■		17/50(4")			
60		-groundwater seepage at 60 feet -clayey siltstone, brown	⊗		10/19/31			
65			■		33/50(5")			



Converse Consultants

Project Name
 MT. SAN ANTONIO COLLEGE
 LOT R PARKING STRUCTURE
 WALNUT, CALIFORNIA

Project No.
 17-31-247-01

Figure No.
 A-4b

Log of Boring No. BH- 3

Dates Drilled: 8/22/2017 Logged by: DA Checked By: MBS

Equipment: 8" HOLLOW STEM AUGER Driving Weight and Drop: 140 lbs / 30 in

Ground Surface Elevation (ft): 760 Depth to Water (ft): 60

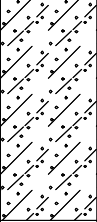
Depth (ft)	Graphic Log	<p style="text-align: center;">SUMMARY OF SUBSURFACE CONDITIONS</p> <p style="font-size: small;">This log is part of the report prepared by Converse for this project and should be read together with the report. This summary applies only at the location of the boring and at the time of drilling. Subsurface conditions may differ at other locations and may change at this location with the passage of time. The data presented is a simplification of actual conditions encountered.</p>	SAMPLES		BLOWS/6"	MOISTURE (%)	DRY UNIT WT. (pcf)	OTHER
			DRIVE	BULK				
75		<p>BEDROCK - PUENTE FORMATION (Tpss): SILTSTONE, SANDSTONE AND CLAYSTONE interbedded, thinly bedded, less weathered, low hardness, diatomaceous layers, brown to grayish brown</p>	<div style="border: 1px solid black; width: 20px; height: 20px; margin: 0 auto; display: flex; align-items: center; justify-content: center;"> X </div>	<div style="border: 1px solid black; width: 20px; height: 20px; margin: 0 auto; display: flex; align-items: center; justify-content: center;"> X </div>	11/20/27			
		<p>End of boring at 76 feet. Groundwater encountered at 60 feet during drilling. Borehole backfilled with soil cuttings and tamped and on 8-22-17.</p>	<div style="border: 1px solid black; width: 20px; height: 20px; margin: 0 auto; background-color: black;"></div>	<div style="border: 1px solid black; width: 20px; height: 20px; margin: 0 auto; background-color: black;"></div>	35/50(4")			



Converse Consultants

Project Name
 MT. SAN ANTONIO COLLEGE
 LOT R PARKING STRUCTURE
 WALNUT, CALIFORNIA

Project No.
 17-31-247-01

Figure No.
 A-4c

Log of Boring No. BH- 4

Dates Drilled: 8/23/2017 Logged by: DA Checked By: MBS

Equipment: 8" HOLLOW STEM AUGER Driving Weight and Drop: 140 lbs / 30 in

Ground Surface Elevation (ft): 728 Depth to Water (ft): 25

Depth (ft)	Graphic Log	SUMMARY OF SUBSURFACE CONDITIONS <small>This log is part of the report prepared by Converse for this project and should be read together with the report. This summary applies only at the location of the boring and at the time of drilling. Subsurface conditions may differ at other locations and may change at this location with the passage of time. The data presented is a simplification of actual conditions encountered.</small>	SAMPLES		BLOWS/6"	MOISTURE (%)	DRY UNIT WT. (pcf)	OTHER
			DRIVE	BULK				
5		FILL (Af): SILTY CLAY (CL): dark brown.	█		1/7/7	26	85	
10		ALLUVIUM (Qal): SANDY SILT (ML): with fine sand, tan to light brown.	█		7/14/28	22	92	
15		BEDROCK-PUENTE FORMATION (Tpss): SILTSTONE AND SANDSTONE: interbedded, thinly bedded, moderately weathered, low hardness, claystone and diatomaceous layers, tan to light brown	█		12/26/42	32	87	
20			█		8/20/35	34	86	
25		☰ -groundwater seepage at 25 feet.	█		12/30/50(4")	29	90	
30			☒		12/20/29			



Converse Consultants

Project Name
MT. SAN ANTONIO COLLEGE
LOT R PARKING STRUCTURE
WALNUT, CALIFORNIA

Project No.
17-31-247-01

Figure No.
A-5a

Log of Boring No. BH- 4

Dates Drilled: 8/23/2017 Logged by: DA Checked By: MBS

Equipment: 8" HOLLOW STEM AUGER Driving Weight and Drop: 140 lbs / 30 in

Ground Surface Elevation (ft): 728 Depth to Water (ft): 25

Depth (ft)	Graphic Log	SUMMARY OF SUBSURFACE CONDITIONS This log is part of the report prepared by Converse for this project and should be read together with the report. This summary applies only at the location of the boring and at the time of drilling. Subsurface conditions may differ at other locations and may change at this location with the passage of time. The data presented is a simplification of actual conditions encountered.	SAMPLES		BLOWS/6"	MOISTURE (%)	DRY UNIT WT. (pcf)	OTHER
			DRIVE	BULK				
40	[Pattern: Diagonal lines]	BEDROCK-PUENTE FORMATION (Tpss): SILTSTONE AND SANDSTONE: interbedded, thinly bedded, moderately weathered, low hardness, claystone and diatomaceous layers	[Symbol: Solid black]		21/50(4")			
45	[Pattern: Diagonal lines]		[Symbol: X]		10/12/37			
50	[Pattern: Diagonal lines]		[Symbol: Solid black]		16/35/50(4")	18	96	
		End of boring at 51 feet. Groundwater encountered at 25 feet during drilling. Borehole backfilled with soil cuttings and tamped on 8-23-17.	[Symbol: X]		12/50(6")			



Converse Consultants

Project Name
 MT. SAN ANTONIO COLLEGE
 LOT R PARKING STRUCTURE
 WALNUT, CALIFORNIA

Project No.
 17-31-247-01

Figure No.
 A-5b

Log of Boring No. BH- 5

Dates Drilled: 8/23/2017 Logged by: DA Checked By: MBS

Equipment: 8" HOLLOW STEM AUGER Driving Weight and Drop: 140 lbs / 30 in

Ground Surface Elevation (ft): 725.5 Depth to Water (ft): 29

Depth (ft)	Graphic Log	SUMMARY OF SUBSURFACE CONDITIONS <small>This log is part of the report prepared by Converse for this project and should be read together with the report. This summary applies only at the location of the boring and at the time of drilling. Subsurface conditions may differ at other locations and may change at this location with the passage of time. The data presented is a simplification of actual conditions encountered.</small>	SAMPLES		BLOWS/6"	MOISTURE (%)	DRY UNIT WT. (pcf)	OTHER
			DRIVE	BULK				
5		FILL (Af) (CL): SILTY SAND (CL): grayish brown to dark brown.	■		10/13/25			
10		ALLUVIUM (Qal): SILTY CLAY (CL): grayish brown to dark brown.						
15		SANDY SILT (ML): tan to light brown.	■		7/14/24	6	106	c
20		BEDROCK - PUENTE FORMATION (Tpss): SILTSTONE AND SANDSTONE: interbedded, thinly bedded, moderately weathered, low hardness, claystone and diatomaceous layers, brown and grayish brown	■		12/20/39	24	93	
25			■		10/12/45	19	95	
30			■		16/41/50(4")	30	91	
30		-groundwater seepage at 29 feet.						
		End of boring at 31.3 feet. Groundwater encountered at 29 feet. Borehole backfilled with soil cuttings and tamped on 8-23-17.			20/30/50(4")	32	87	



Converse Consultants

Project Name
MT. SAN ANTONIO COLLEGE
LOT R PARKING STRUCTURE
WALNUT, CALIFORNIA

Project No.
17-31-247-01

Figure No.
A-6

Log of Boring No. BH- 6

Dates Drilled: 8/23/2017 Logged by: DA Checked By: MBS

Equipment: 8" HOLLOW STEM AUGER Driving Weight and Drop: 140 lbs / 30 in

Ground Surface Elevation (ft): 724.5 Depth to Water (ft): 20

Depth (ft)	Graphic Log	SUMMARY OF SUBSURFACE CONDITIONS <small>This log is part of the report prepared by Converse for this project and should be read together with the report. This summary applies only at the location of the boring and at the time of drilling. Subsurface conditions may differ at other locations and may change at this location with the passage of time. The data presented is a simplification of actual conditions encountered.</small>	SAMPLES		BLOWS/6"	MOISTURE (%)	DRY UNIT WT. (pcf)	OTHER
			DRIVE	BULK				
5		FILL (Af): SILTY CLAY (CL): some fine sand, dark brown.	█		10/16/7	14	122	ma,max
10		ALLUVIUM (Qal): SILTY CLAY (CL): some fine sand, dark brown.	█		5/12/18	10	110	
15		SILTY SAND (SM): medium to coarse-grained, some gravel, reddish brown.	█		7/8/14	23	100	
20		-groundwater at 20 feet SILT (ML): dark brown.	█		9/8/6	19	96	
25		SILTY SAND (SM): fine-grained, grayish brown.	█		4/4/6	10	115	
30			█		13/50(6")	7	125	



Converse Consultants

Project Name
MT. SAN ANTONIO COLLEGE
LOT R PARKING STRUCTURE
WALNUT, CALIFORNIA

Project No.
17-31-247-01

Figure No.
A-7a

Log of Boring No. BH- 6

Dates Drilled: 8/23/2017 Logged by: DA Checked By: MBS

Equipment: 8" HOLLOW STEM AUGER Driving Weight and Drop: 140 lbs / 30 in

Ground Surface Elevation (ft): 724.5 Depth to Water (ft): 20

Depth (ft)	Graphic Log	SUMMARY OF SUBSURFACE CONDITIONS <small>This log is part of the report prepared by Converse for this project and should be read together with the report. This summary applies only at the location of the boring and at the time of drilling. Subsurface conditions may differ at other locations and may change at this location with the passage of time. The data presented is a simplification of actual conditions encountered.</small>	SAMPLES		BLOWS/6"	MOISTURE (%)	DRY UNIT WT. (pcf)	OTHER
			DRIVE	BULK				
40	[Dotted pattern]	SILTY SAND (SM): fine to coarse-grained, reddish brown.	X		13/24/40			
45	[Diagonal lines]	BEDROCK - PUENTE FORMATION (Tpss): SILTSTONE AND SANDSTONE: interbedded, moderately weathered, thinly bedded, low hardness, claystone and diatomaceous layers, grayish brown and brown	X		8/12/25			
50	[Diagonal lines]				16/31/50	32	90	
		End of boring at 51.5 feet. Groundwater encountered at 20 feet during drilling. Borehole backfilled with soil cuttings and tamped on 8-22-17.						



Converse Consultants

Project Name
MT. SAN ANTONIO COLLEGE
LOT R PARKING STRUCTURE
WALNUT, CALIFORNIA

Project No.
17-31-247-01

Figure No.
A-7b

Log of Boring No. BH- 7

Dates Drilled: 8/23/2017 Logged by: DA Checked By: MBS

Equipment: 8" HOLLOW STEM AUGER Driving Weight and Drop: 140 lbs / 30 in

Ground Surface Elevation (ft): 730 Depth to Water (ft): 31.5

Depth (ft)	Graphic Log	SUMMARY OF SUBSURFACE CONDITIONS <small>This log is part of the report prepared by Converse for this project and should be read together with the report. This summary applies only at the location of the boring and at the time of drilling. Subsurface conditions may differ at other locations and may change at this location with the passage of time. The data presented is a simplification of actual conditions encountered.</small>	SAMPLES		BLOWS/6"	MOISTURE (%)	DRY UNIT WT. (pcf)	OTHER
			DRIVE	BULK				
5	FILL (Af): CLAY (CL): slightly silty, dark gray to black.		■		6/9/16	28	92	se
10	ALLUVIUM (Qal): CLAY (CL): some silt, dark gray to black.		■		5/15/20	19	96	ds
15	SILTY CLAY (CL): dark brown.		■		8/18/23	30	88	
20	SILT (ML): grayish brown. -whitish gray and brown		■		7/13/21	35	80	
25			■		10/19/22	11	116	
30	BEDROCK - PUENTE FORMATION (Tpss): SILTSTONE: thinly bedded, weathered, brown to gray		■		13/24/27	40	90	
	End of boring at 31.5 feet. Groundwater not encountered during drilling. Borehole backfilled with soil cuttings and tamped on 8-23-17.							



Converse Consultants

Project Name
 MT. SAN ANTONIO COLLEGE
 LOT R PARKING STRUCTURE
 WALNUT, CALIFORNIA

Project No.
 17-31-247-01

Figure No.
 A-8

Log of Boring No. BH- 8

Dates Drilled: 8/24/2017 Logged by: DA Checked By: MBS

Equipment: 8" HOLLOW STEM AUGER Driving Weight and Drop: 140 lbs / 30 in

Ground Surface Elevation (ft): 729 Depth to Water (ft): 23

Depth (ft)	Graphic Log	SUMMARY OF SUBSURFACE CONDITIONS <small>This log is part of the report prepared by Converse for this project and should be read together with the report. This summary applies only at the location of the boring and at the time of drilling. Subsurface conditions may differ at other locations and may change at this location with the passage of time. The data presented is a simplification of actual conditions encountered.</small>	SAMPLES		BLOWS/6"	MOISTURE (%)	DRY UNIT WT. (pcf)	OTHER
			DRIVE	BULK				
5		FILL (Af): SILTY CLAY (CL): dark gray to black.						r
10		ALLUVIUM (Qal): CLAY (CL): dark gray to black. -dark brown			5/8/14	22	86	pi
15		SILTY SAND (SM): dark brown.			7/14/21	24	97	
20		SAND (ML): dark brown. -groundwater at 23 feet			5/7/15	14	109	wa(36%)
25		-slightly clayey			5/6/10	24	95	
30		-sand layer at bottom of sample			5/5/7	28	86	
		End of boring at 31.5 feet. Groundwater encountered at 23 feet. Borehole backfilled with soil cuttings and tamped on 8-22-17.			4/8/21	22	86	



Converse Consultants

Project Name
MT. SAN ANTONIO COLLEGE
LOT R PARKING STRUCTURE
WALNUT, CALIFORNIA

Project No.
17-31-247-01

Figure No.
A-9

Log of Boring No. BH- 9

Dates Drilled: 8/24/2017 Logged by: DA Checked By: MBS

Equipment: 8" HOLLOW STEM AUGER Driving Weight and Drop: 140 lbs / 30 in

Ground Surface Elevation (ft): 732 Depth to Water (ft): 23

Depth (ft)	Graphic Log	SUMMARY OF SUBSURFACE CONDITIONS <small>This log is part of the report prepared by Converse for this project and should be read together with the report. This summary applies only at the location of the boring and at the time of drilling. Subsurface conditions may differ at other locations and may change at this location with the passage of time. The data presented is a simplification of actual conditions encountered.</small>	SAMPLES		BLOWS/6"	MOISTURE (%)	DRY UNIT WT. (pcf)	OTHER
			DRIVE	BULK				
5		ALLUVIUM (Qal): SILTY CLAY (CL): dark brown.	■	■	5/10/14	28	92	
10		ALLUVIUM (Qal): SILTY CLAY (CL): dark brown to brown.	■	■	6/15/20	20	103	
15		SILT (ML): grayish brown. -dark brown	■	■	4/8/16	29	92	
20		-dark brown -groundwater at 23 feet	■	■	4/6/8	35	80	
25		BEDROCK - PUENTE FORMATION (Tpss): SILTSTONE: thinly bedded, interbedded sandstone and claystone layers, moderately weathered, low hardness, grayish brown to gray	■	■	4/6/10	32	89	
30			■	■	6/12/20	27	81	
		End of boring at 31.5 feet. Groundwater encountered at 23 feet during drilling. Borehole backfilled with soil cuttings and tamped on 8-24-17.						



Converse Consultants

Project Name
MT. SAN ANTONIO COLLEGE
LOT R PARKING STRUCTURE
WALNUT, CALIFORNIA

Project No.
17-31-247-01

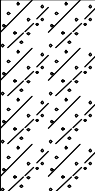

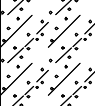

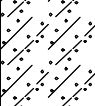

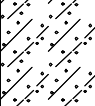

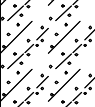

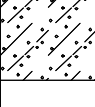

Figure No.
A-10

Log of Boring No. BH-10

Dates Drilled: 8/23/2017 Logged by: DA Checked By: MBS

Equipment: 8" HOLLOW STEM AUGER Driving Weight and Drop: 140 lbs / 30 in

Ground Surface Elevation (ft): 737 Depth to Water (ft): NOT ENCOUNTERED

Depth (ft)	Graphic Log	SUMMARY OF SUBSURFACE CONDITIONS <small>This log is part of the report prepared by Converse for this project and should be read together with the report. This summary applies only at the location of the boring and at the time of drilling. Subsurface conditions may differ at other locations and may change at this location with the passage of time. The data presented is a simplification of actual conditions encountered.</small>	SAMPLES		BLOWS/6"	MOISTURE (%)	DRY UNIT WT. (pcf)	OTHER
			DRIVE	BULK				
5		BEDROCK - PUENTE FORMATION (Tpss): SILTSTONE, SANDSTONE AND CLAYSTONE: thinly bedded, moderately weathered, low hardness, diatomaceous layers, olive gray to gay			7/12/15	35	86	
10					6/8/11			
15		-grayish brown, thinly bedded, low hardness			8/11/21	32	89	
20					11/20/23	37	93	
25		-with thin lenses of sandstone			11/18/22	37	92	
30					15/29/40	30	88	
		End of boring at 31.5 feet. Groundwater not encountered during drilling. Borehole backfilled with soil cuttings and tamped on 8-23-17.						



Converse Consultants

Project Name
 MT. SAN ANTONIO COLLEGE
 LOT R PARKING STRUCTURE
 WALNUT, CALIFORNIA

Project No.
 17-31-247-01

Figure No.
 A-11

Log of Boring No. BH-11

Dates Drilled: 8/24/2017 Logged by: DA Checked By: MBS

Equipment: 8" HOLLOW STEM AUGER Driving Weight and Drop: 140 lbs / 30 in

Ground Surface Elevation (ft): 735 Depth to Water (ft): 22

Depth (ft)	Graphic Log	SUMMARY OF SUBSURFACE CONDITIONS <small>This log is part of the report prepared by Converse for this project and should be read together with the report. This summary applies only at the location of the boring and at the time of drilling. Subsurface conditions may differ at other locations and may change at this location with the passage of time. The data presented is a simplification of actual conditions encountered.</small>	SAMPLES		BLOWS/6"	MOISTURE (%)	DRY UNIT WT. (pcf)	OTHER
			DRIVE	BULK				
5		ALLUVIUM (Qal): SILTY CLAY (CL): dark brown.						ma
10		ALLUVIUM: SILTY CLAY (CL): brown to dark brown.			8/13/20	25	88	
15		SILTY SAND (SM): with fine sand, brown.			7/10/15	13	109	
20					4/7/7	15	117	wa (fc=36%)
25		-groundwater at 22 feet -some clay, dark brown			2/2/3			
30					2/4/14	25	104	wa (fc=29%)
30		SILT (ML): some sand, brown.			19/18/9			



Converse Consultants

Project Name
MT. SAN ANTONIO COLLEGE
LOT R PARKING STRUCTURE
WALNUT, CALIFORNIA

Project No.
17-31-247-01

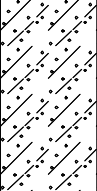
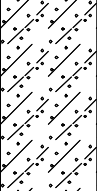

Figure No.
A-12a

Log of Boring No. BH-11

Dates Drilled: 8/24/2017 Logged by: DA Checked By: MBS

Equipment: 8" HOLLOW STEM AUGER Driving Weight and Drop: 140 lbs / 30 in

Ground Surface Elevation (ft): 735 Depth to Water (ft): 22

Depth (ft)	Graphic Log	SUMMARY OF SUBSURFACE CONDITIONS <small>This log is part of the report prepared by Converse for this project and should be read together with the report. This summary applies only at the location of the boring and at the time of drilling. Subsurface conditions may differ at other locations and may change at this location with the passage of time. The data presented is a simplification of actual conditions encountered.</small>	SAMPLES		BLOWS/6"	MOISTURE (%)	DRY UNIT WT. (pcf)	OTHER
			DRIVE	BULK				
40		<p>BEDROCK - PUENTE FORMATION (Tpss): SILTSTONE, SANDSTONE AND CLAYSTONE: interbedded, thinly bedded, moderately weathered, low hardness, diatomaceous layers, grayish brown to brown</p> <p style="text-align: center;">-dark gray to black</p>	■	■	6/11/15			wa (fc=71%)
45			X	X	5/6/9			
50			■	■	7/16/50(5")			
		<p>End of boring at 51.5 feet. Groundwater encountered at 22 feet during drilling. Borehole backfilled with soil cuttings and tamped on 8-24-17.</p>	X	X	8/15/24			



Converse Consultants

Project Name
 MT. SAN ANTONIO COLLEGE
 LOT R PARKING STRUCTURE
 WALNUT, CALIFORNIA

Project No.
 17-31-247-01

Figure No.
 A-12b

SUMMARY
OF
CONE PENETRATION TEST DATA

Project:

Mount San Antonio College (Lot R)
1100 N. Grand Avenue
Walnut, CA
September 6-7, 2017

Prepared for:

Mr. Ram Ariram
Converse Consultants
717 S. Myrtle Avenue
Monrovia, CA 91016
Office (626) 930-1200 / Fax (626) 930-1212

Prepared by:



KEHOE TESTING & ENGINEERING

5415 Industrial Drive
Huntington Beach, CA 92649-1518
Office (714) 901-7270 / Fax (714) 901-7289
www.kehoetesting.com

TABLE OF CONTENTS

- 1. INTRODUCTION**
- 2. SUMMARY OF FIELD WORK**
- 3. FIELD EQUIPMENT & PROCEDURES**
- 4. CONE PENETRATION TEST DATA & INTERPRETATION**

APPENDIX

- CPT Plots
- CPT Classification/Soil Behavior Chart
- Interpretation Output (CPeT-IT)
- CPeT-IT Calculation Formulas

SUMMARY OF CONE PENETRATION TEST DATA

1. INTRODUCTION

This report presents the results of a Cone Penetration Test (CPT) program carried out for the Mount San Antonio College (Lot R) project located at 1100 N. Grand Avenue in Walnut, California. The work was performed by Kehoe Testing & Engineering (KTE) on September 6-7, 2017. The scope of work was performed as directed by Converse Consultants personnel.

2. SUMMARY OF FIELD WORK

The fieldwork consisted of performing CPT soundings at 17 locations to determine the soil lithology. Groundwater measurements and hole collapse depths provided in **TABLE 2.1** are for information only. The readings indicate the apparent depth to which the hole is open and the apparent water level (if encountered) in the CPT probe hole at the time of measurement upon completion of the CPT. KTE does not warranty the accuracy of the measurements and the reported water levels may not represent the true or stabilized groundwater levels.

LOCATION	DEPTH OF CPT (ft)	COMMENTS/NOTES:
CPT-1	43	Refusal, hole open to 10.0 ft (dry)
CPT-2	59	Refusal, hole open to 59.0 ft (dry)
CPT-3	30	Hole open to 12.0 ft (dry)
CPT-4	50	Hole open to 19.0 ft (dry)
CPT-5	41	Refusal, hole caved @ surface
CPT-6	30	Hole open to 19.6 ft (dry)
CPT-7	39	Refusal, hole open to 12.0 ft (dry)

LOCATION	DEPTH OF CPT (ft)	COMMENTS/NOTES:
CPT-8	30	Hole open to 26.0 ft (dry)
CPT-9	50	Groundwater @ 24.0 ft
CPT-10	26	Hole open to 26.0 ft (dry)
CPT-11	50	Hole open to 29.0 ft (dry)
CPT-12	25	Hole open to 20.6 ft (dry)
CPT-13	30	Hole caved @ surface
CPT-14	50	Hole open to 21.0 ft (dry)
CPT-15	50	Hole caved @ surface
CPT-16	75	Hole open to 55.5 ft (dry)
CPT-17	37	Refusal, hole open to 10.0 ft (dry)

TABLE 2.1 - Summary of CPT Soundings

3. FIELD EQUIPMENT & PROCEDURES

The CPT soundings were carried out by **KTE** using an integrated electronic cone system manufactured by Vertek. The CPT soundings were performed in accordance with ASTM standards (D5778). The cone penetrometers were pushed using a 30-ton CPT rig. The cone used during the program was a 15 cm² cone and recorded the following parameters at approximately 2.5 cm depth intervals:

- Cone Resistance (qc)
- Sleeve Friction (fs)
- Dynamic Pore Pressure (u)
- Inclination
- Penetration Speed

The above parameters were recorded and viewed in real time using a laptop computer. Data is stored at the KTE office for up to 2 years for future analysis and reference. A complete set of baseline readings was taken prior to each sounding to determine temperature shifts and any zero load offsets. Monitoring base line readings ensures that the cone electronics are operating properly.

4. CONE PENETRATION TEST DATA & INTERPRETATION

The Cone Penetration Test data is presented in graphical form in the attached Appendix. These plots were generated using the CPeT-IT program. Penetration depths are referenced to ground surface. The soil classification on the CPT plots is derived from the attached CPT Classification Chart (Robertson) and presents major soil lithologic changes. The stratigraphic interpretation is based on relationships between cone resistance (qc), sleeve friction (fs), and penetration pore pressure (u). The friction ratio (Rf), which is sleeve friction divided by cone resistance, is a calculated parameter that is used along with cone resistance to infer soil behavior type. Generally, cohesive soils (clays) have high friction ratios, low cone resistance and generate excess pore water pressures. Cohesionless soils (sands) have lower friction ratios, high cone bearing and generate little (or negative) excess pore water pressures.

Tables of basic CPT output from the interpretation program CPeT-IT are provided for CPT data averaged over one foot intervals in the Appendix. We recommend a geotechnical engineer review the assumed input parameters and the calculated output from the CPeT-IT program. A summary of the equations used for the tabulated parameters is provided in the Appendix.

It should be noted that it is not always possible to clearly identify a soil type based on qc, fs and u. In these situations, experience, judgement and an assessment of the pore pressure data should be used to infer the soil behavior type.

If you have any questions regarding this information, please do not hesitate to call our office at (714) 901-7270.

Sincerely,

KEHOE TESTING & ENGINEERING

A handwritten signature in black ink, appearing to read "Richard W. Koester, Jr.", written in a cursive style.

Richard W. Koester, Jr.
General Manager

09/14/17-kk-8632-1

APPENDIX



Kehoe Testing and Engineering
 714-901-7270
 rich@kehoetesting.com
 www.kehoetesting.com

Project: Converse Consultants/Mount San Antonio College (Lot R)
Location: 1100 N. Grand Ave Walnut, CA

CPT-1

Total depth: 43.24 ft, Date: 9/6/2017

Cone Type: Vertek

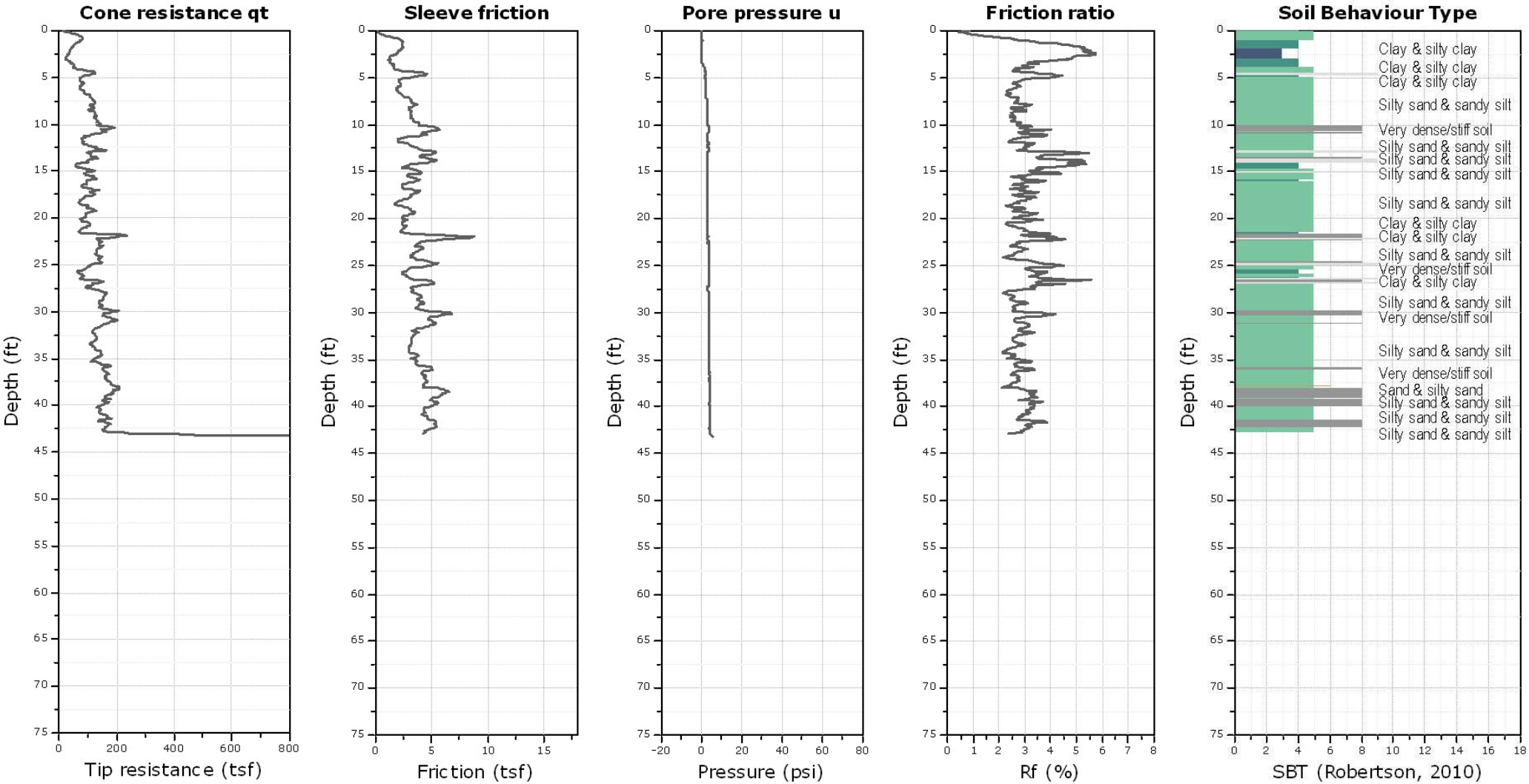



Kehoe Testing and Engineering
 714-901-7270
 rich@kehoetesting.com
 www.kehoetesting.com

Project: Converse Consultants/Mount San Antonio College (Lot R)
Location: 1100 N. Grand Ave Walnut, CA

CPT-2

Total depth: 59.59 ft, Date: 9/6/2017

Cone Type: Vertek

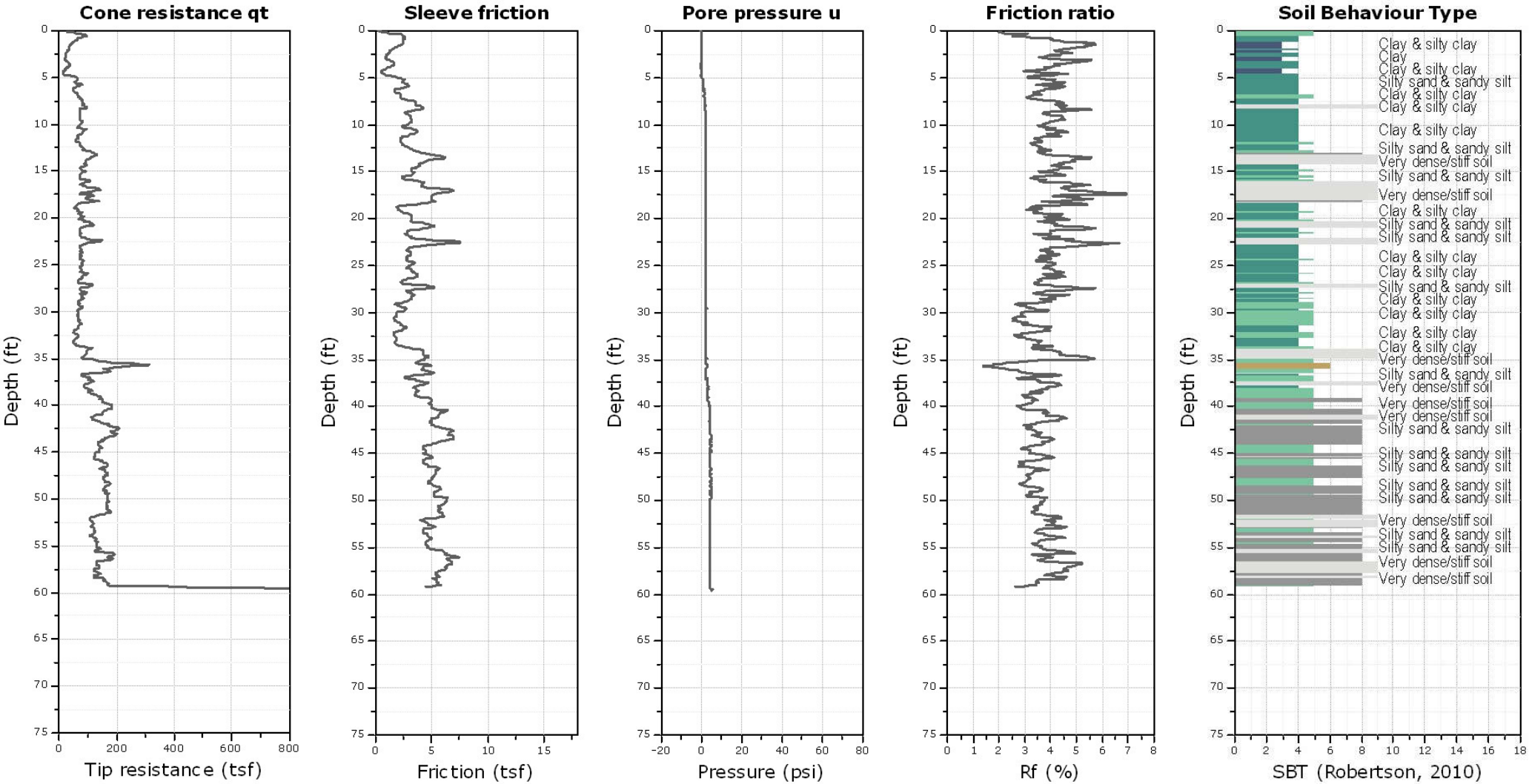



Kehoe Testing and Engineering
 714-901-7270
 rich@kehoetesting.com
 www.kehoetesting.com

Project: Converse Consultants/Mount San Antonio College (Lot R)
Location: 1100 N. Grand Ave Walnut, CA

CPT-3

Total depth: 30.40 ft, Date: 9/6/2017

Cone Type: Vertek

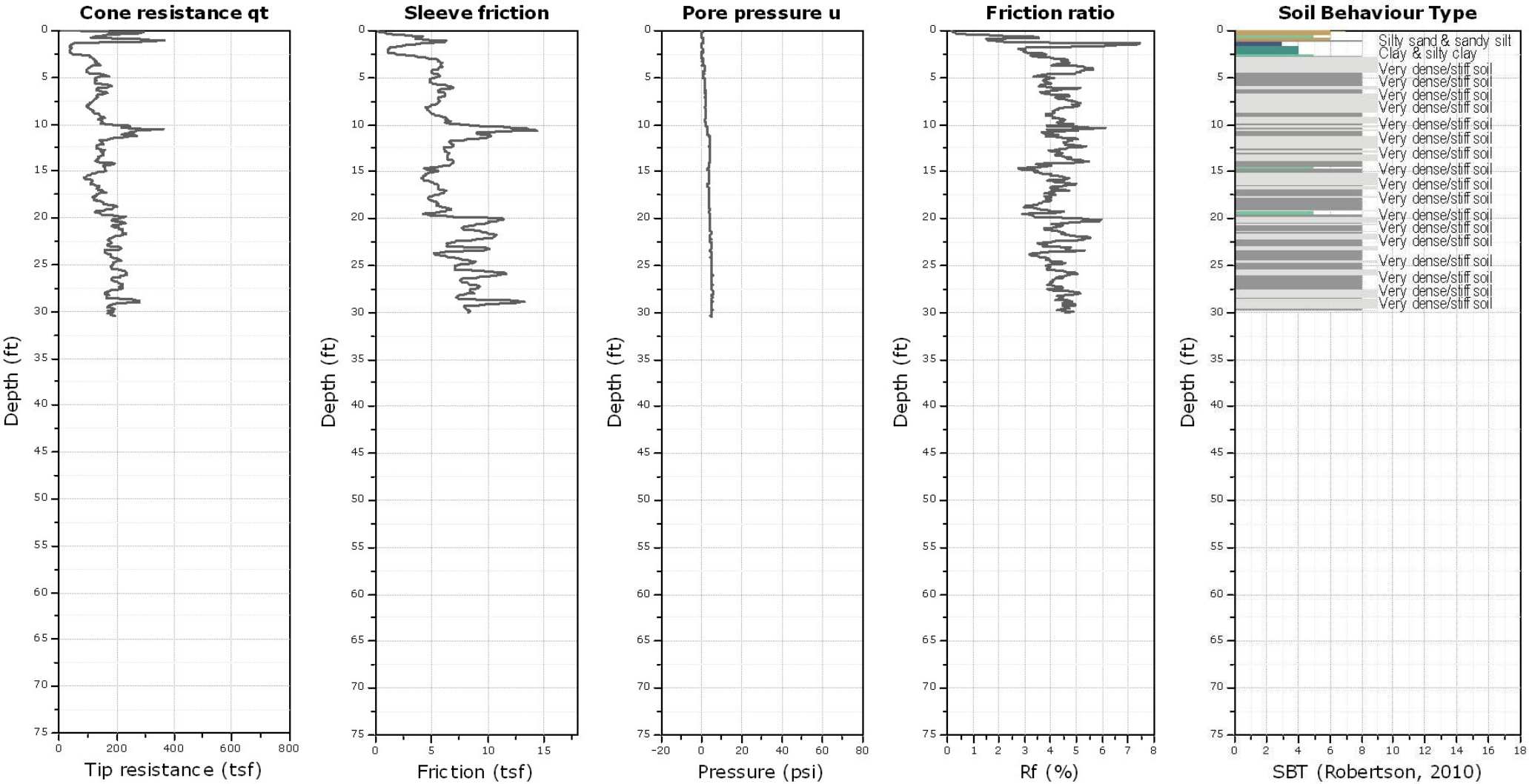



Kehoe Testing and Engineering
 714-901-7270
 rich@kehoetesting.com
 www.kehoetesting.com

Project: Converse Consultants/Mount San Antonio College (Lot R)
Location: 1100 N. Grand Ave Walnut, CA

CPT-5

Total depth: 41.56 ft, Date: 9/6/2017

Cone Type: Vertek

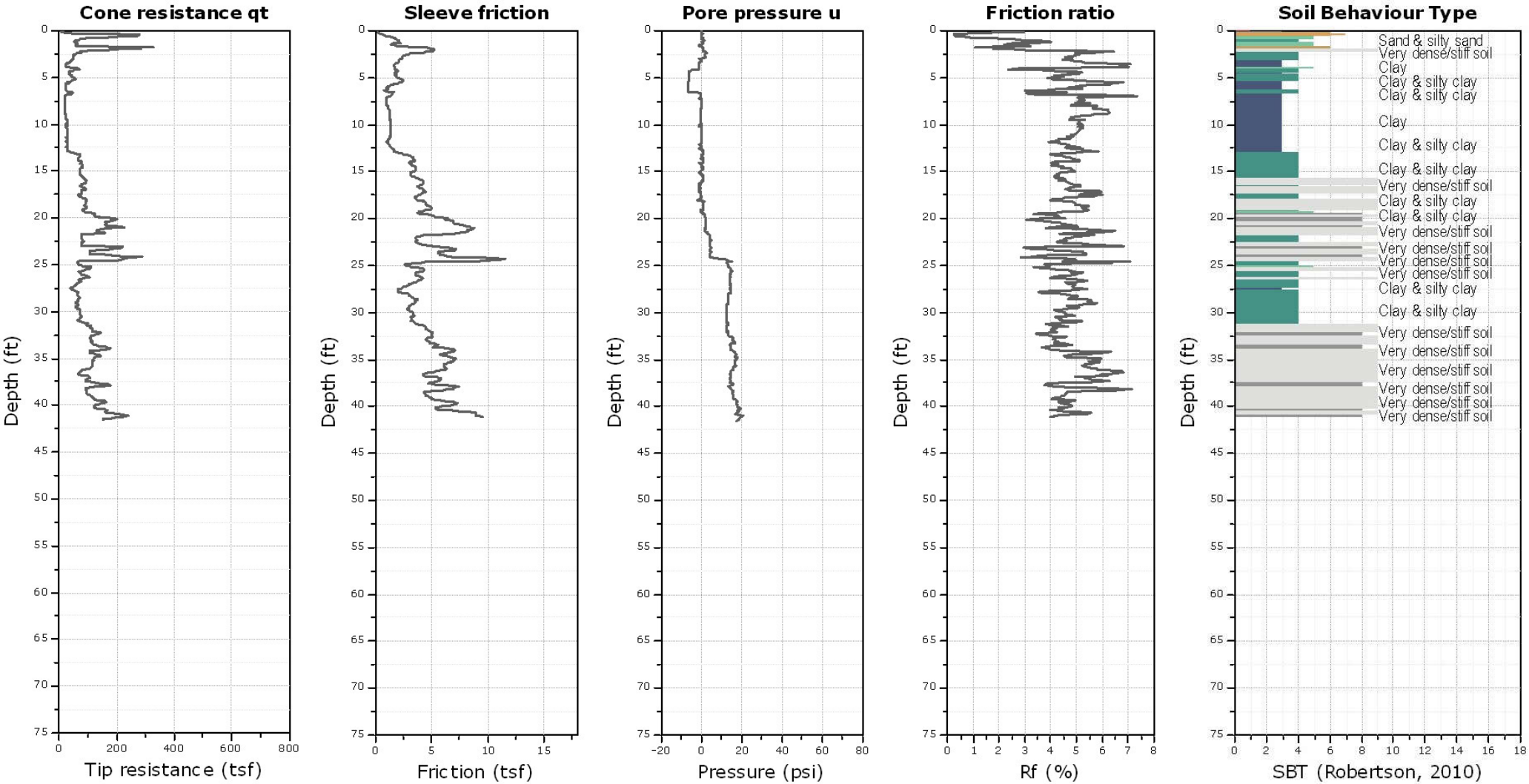



Kehoe Testing and Engineering
 714-901-7270
 rich@kehoetesting.com
 www.kehoetesting.com

Project: Converse Consultants/Mount San Antonio College (Lot R)
Location: 1100 N. Grand Ave Walnut, CA

CPT-6

Total depth: 30.41 ft, Date: 9/6/2017

Cone Type: Vertek

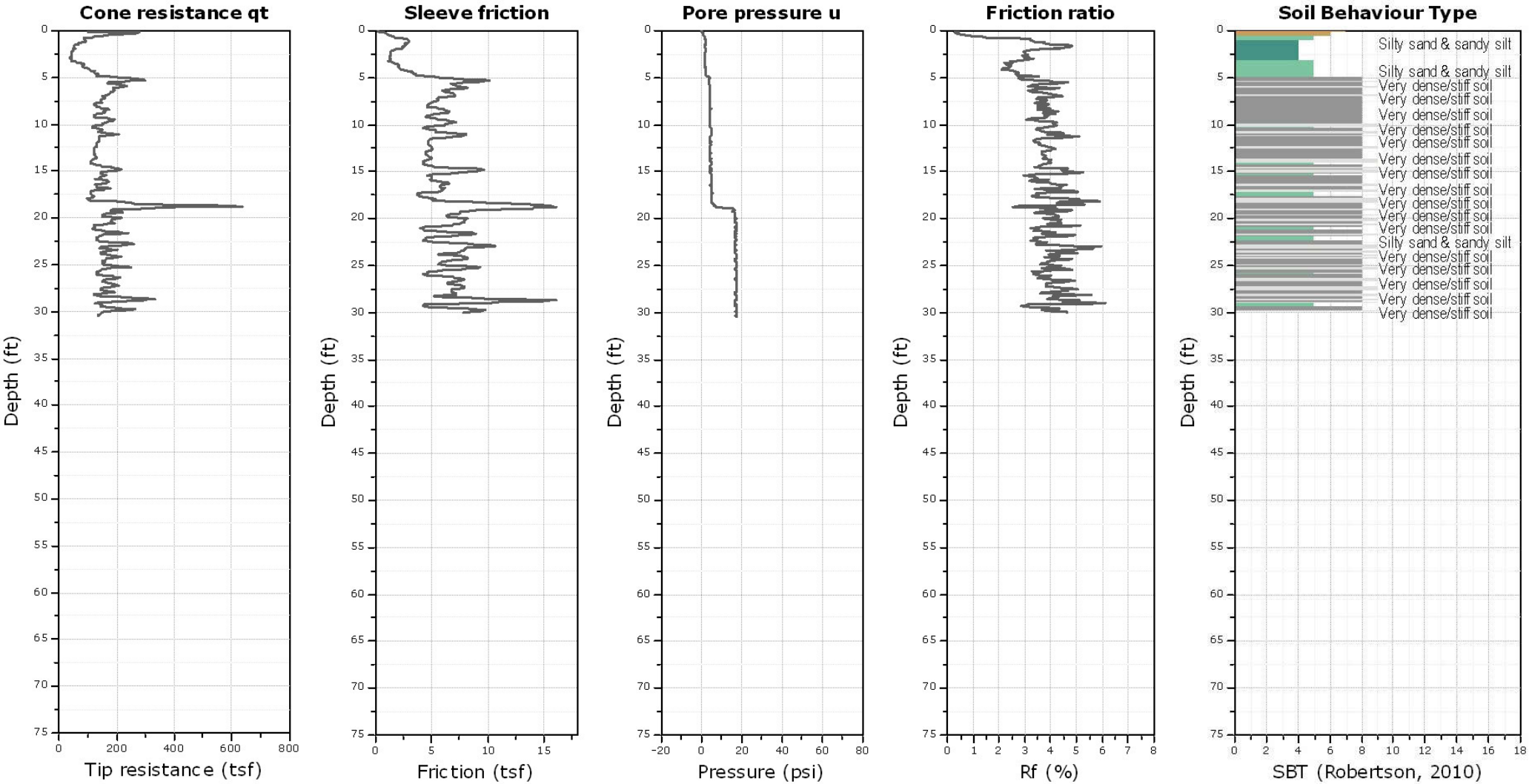



Kehoe Testing and Engineering
 714-901-7270
 rich@kehoetesting.com
 www.kehoetesting.com

Project: Converse Consultants/Mount San Antonio College (Lot R)
Location: 1100 N. Grand Ave Walnut, CA

CPT-7

Total depth: 39.96 ft, Date: 9/6/2017

Cone Type: Vertek

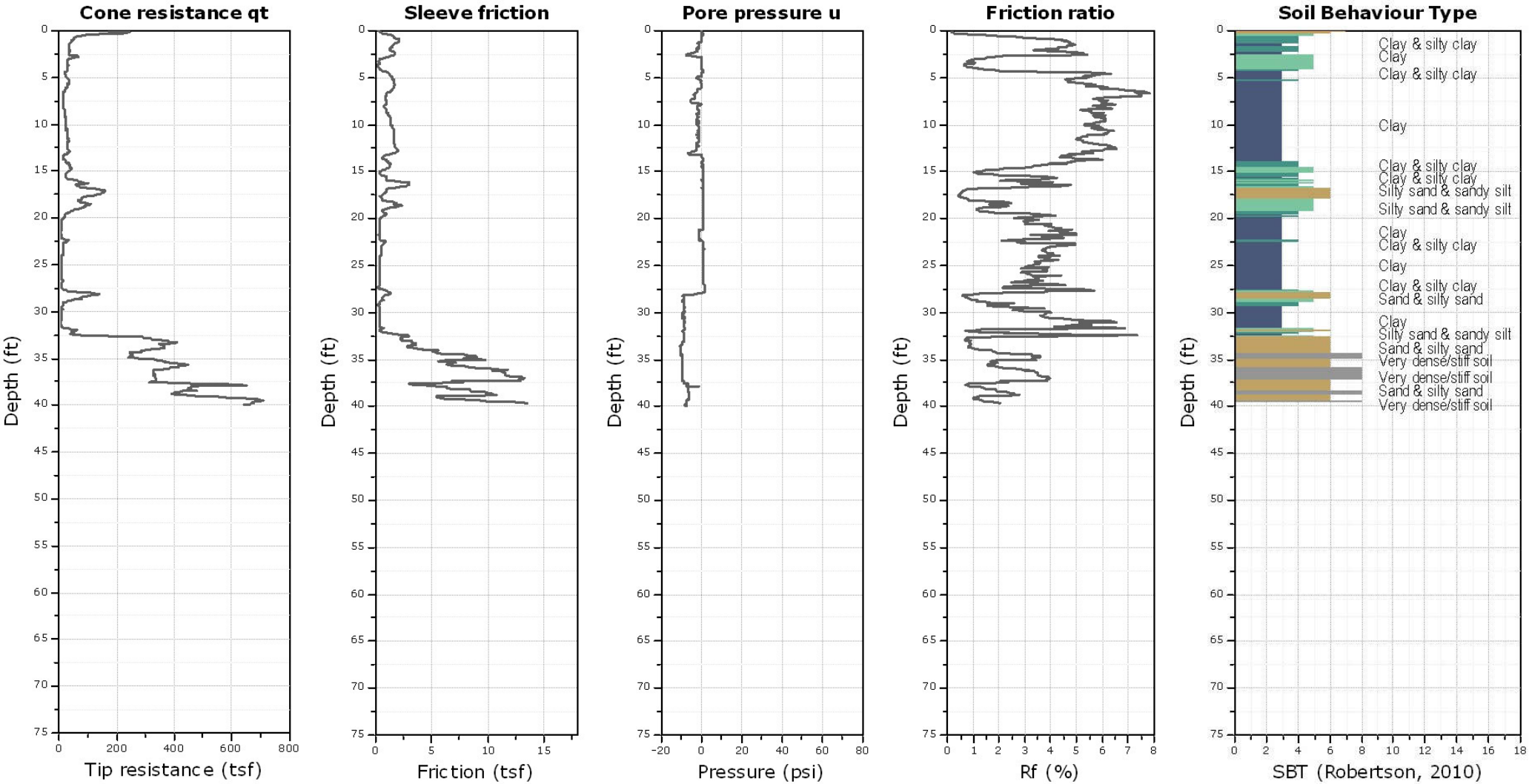



Kehoe Testing and Engineering
714-901-7270
rich@kehoetesting.com
www.kehoetesting.com

Project: Converse Consultants/Mount San Antonio College (Lot R)
Location: 1100 N. Grand Ave Walnut, CA

CPT-8

Total depth: 30.45 ft, Date: 9/6/2017

Cone Type: Vertek

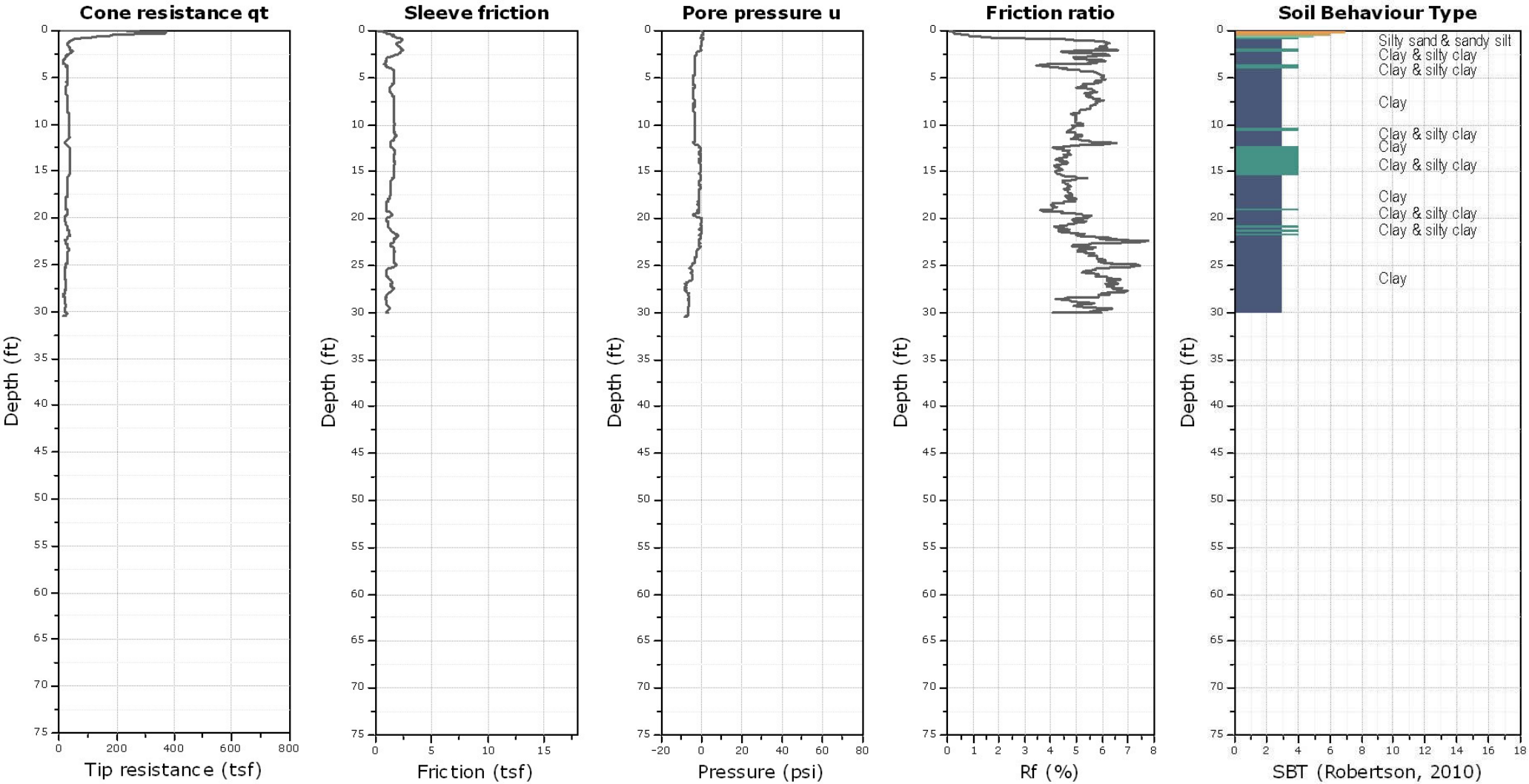



Kehoe Testing and Engineering
 714-901-7270
 rich@kehoetesting.com
 www.kehoetesting.com

Project: Converse Consultants/Mount San Antonio College (Lot R)
Location: 1100 N. Grand Ave Walnut, CA

CPT-9

Total depth: 50.34 ft, Date: 9/6/2017

Cone Type: Vertek

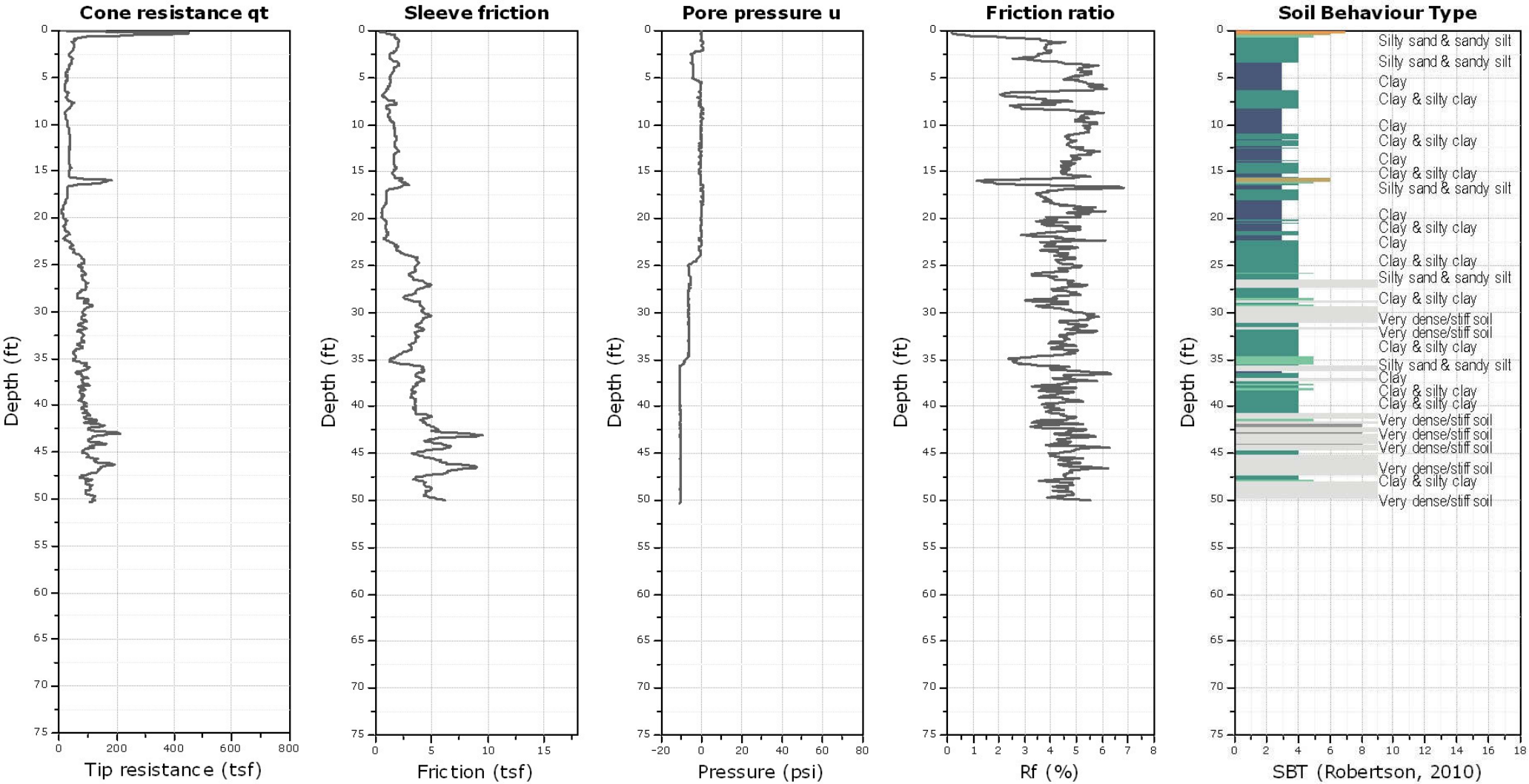



Kehoe Testing and Engineering
714-901-7270
rich@kehoetesting.com
www.kehoetesting.com

Project: Converse Consultants/Mount San Antonio College (Lot R)
Location: 1100 N. Grand Ave Walnut, CA

CPT-10

Total depth: 26.25 ft, Date: 9/7/2017
Cone Type: Vertek

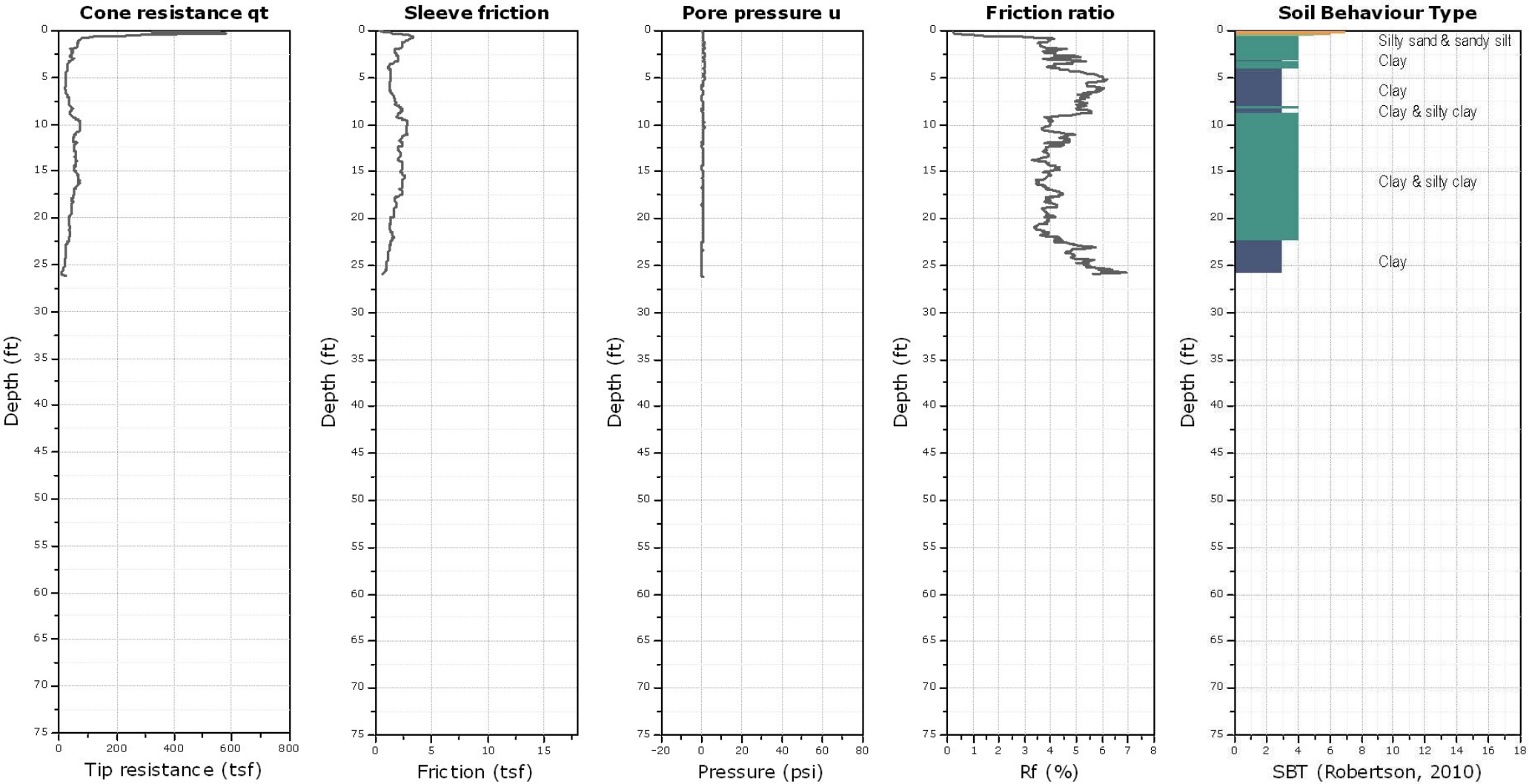



Kehoe Testing and Engineering
 714-901-7270
 rich@kehoetesting.com
 www.kehoetesting.com

Project: Converse Consultants/Mount San Antonio College (Lot R)
Location: 1100 N. Grand Ave Walnut, CA

CPT-11

Total depth: 50.29 ft, Date: 9/7/2017

Cone Type: Vertek

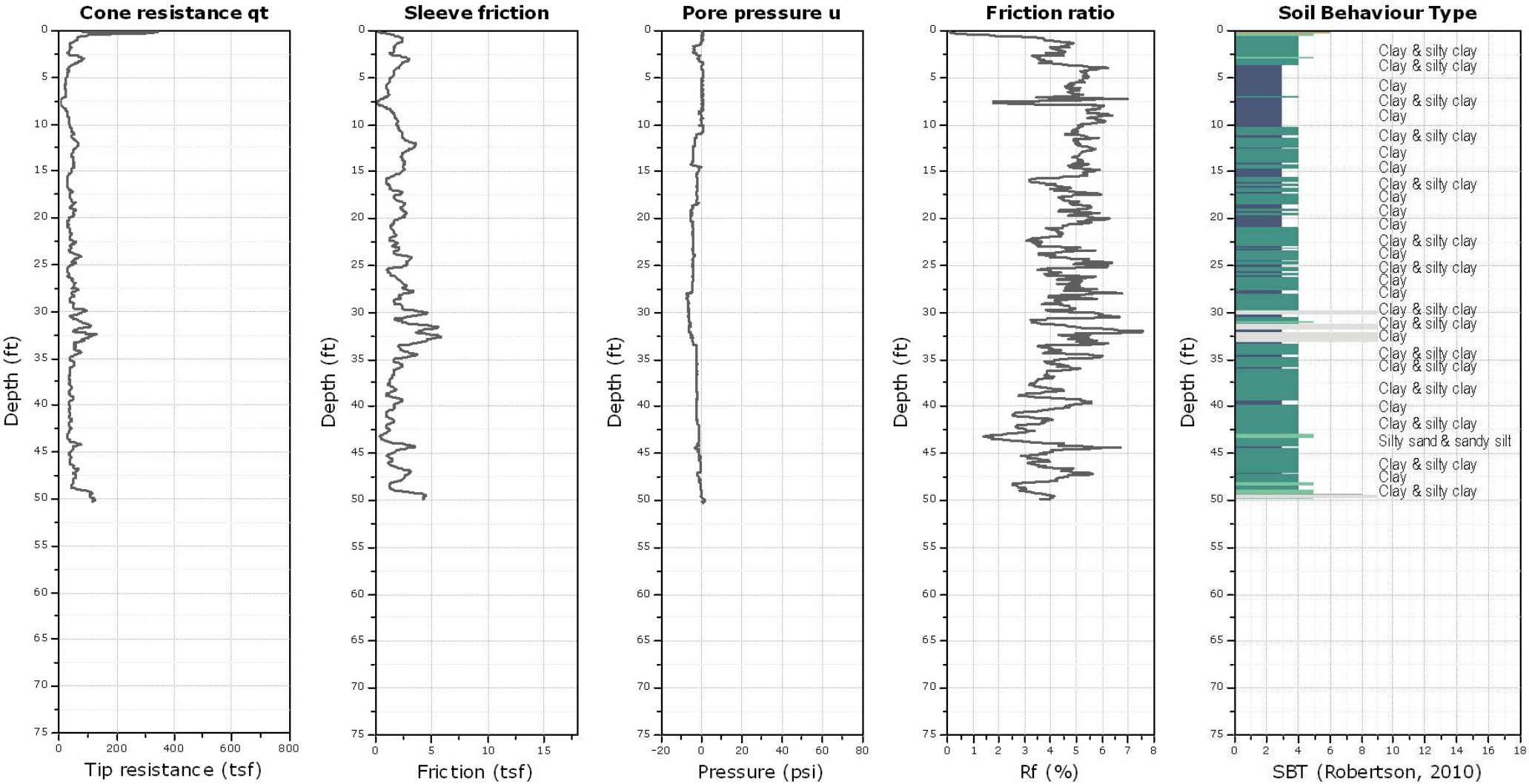



Kehoe Testing and Engineering
714-901-7270
rich@kehoetesting.com
www.kehoetesting.com

Project: Converse Consultants/Mount San Antonio College (Lot R)
Location: 1100 N. Grand Ave Walnut, CA

CPT-12

Total depth: 25.20 ft, Date: 9/7/2017

Cone Type: Vertek

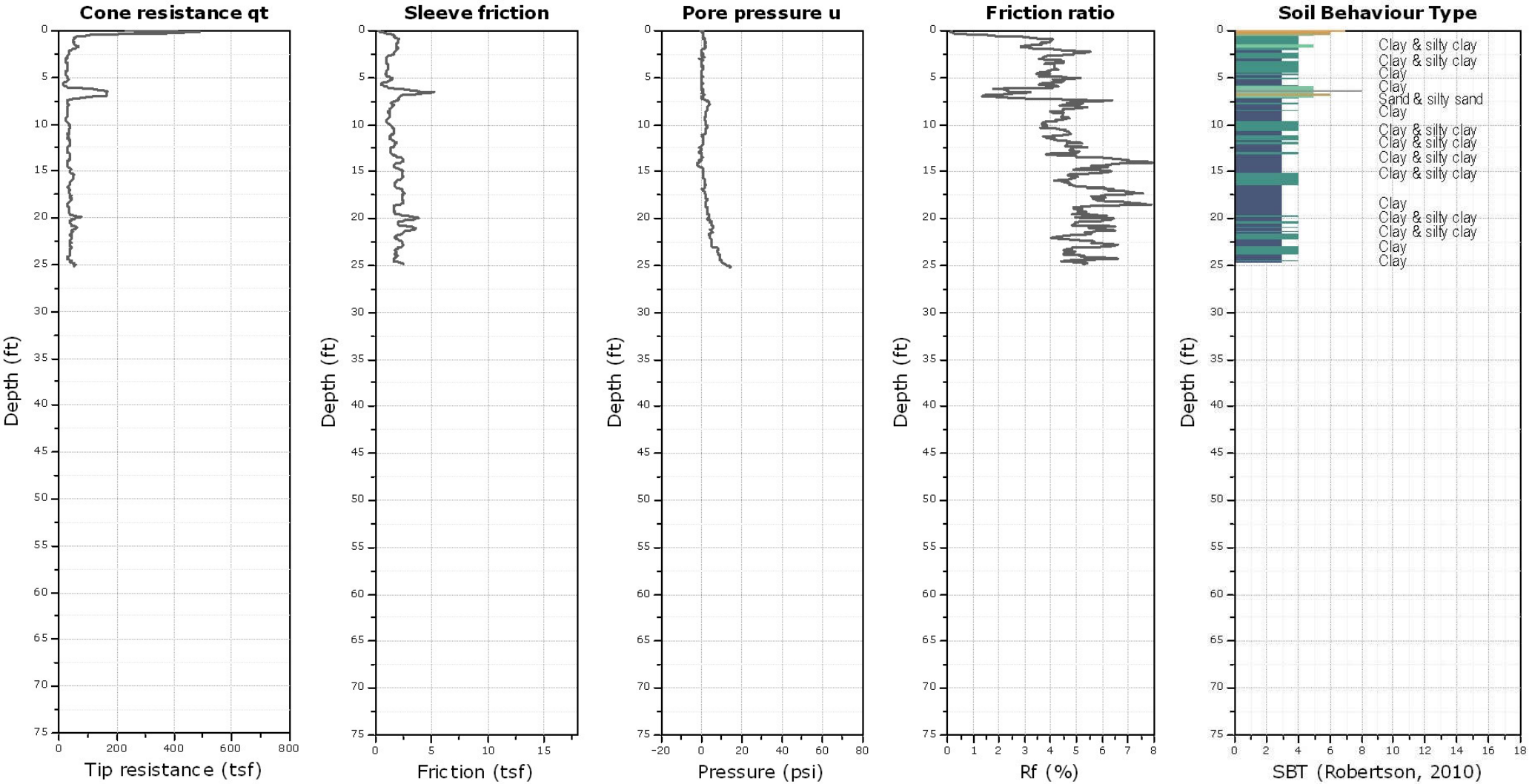



Kehoe Testing and Engineering
714-901-7270
rich@kehoetesting.com
www.kehoetesting.com

Project: Converse Consultants/Mount San Antonio College (Lot R)
Location: 1100 N. Grand Ave Walnut, CA

CPT-13

Total depth: 30.19 ft, Date: 9/7/2017

Cone Type: Vertek

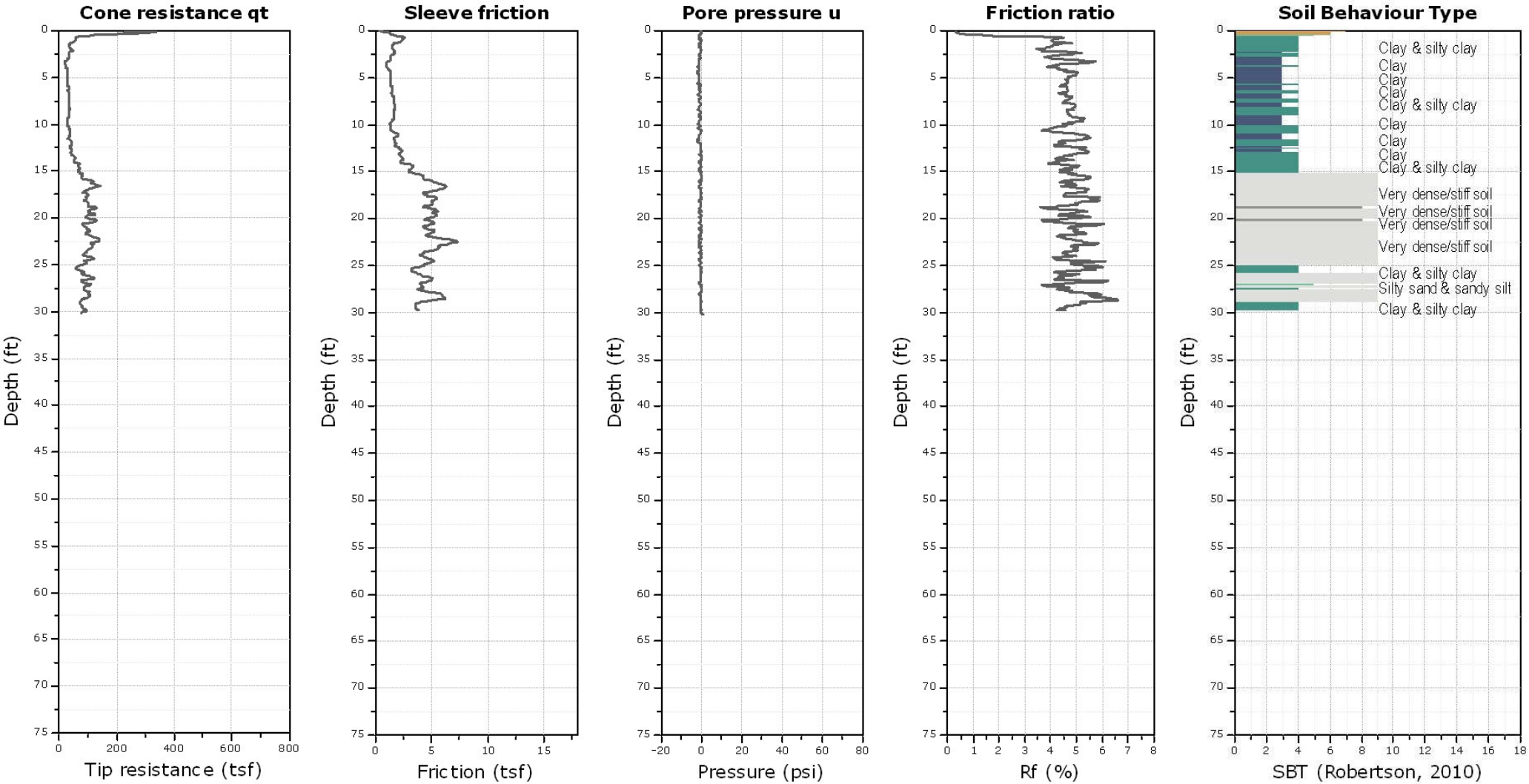



Kehoe Testing and Engineering
 714-901-7270
 rich@kehoetesting.com
 www.kehoetesting.com

Project: Converse Consultants/Mount San Antonio College (Lot R)
Location: 1100 N. Grand Ave Walnut, CA

CPT-15

Total depth: 50.42 ft, Date: 9/7/2017

Cone Type: Vertek

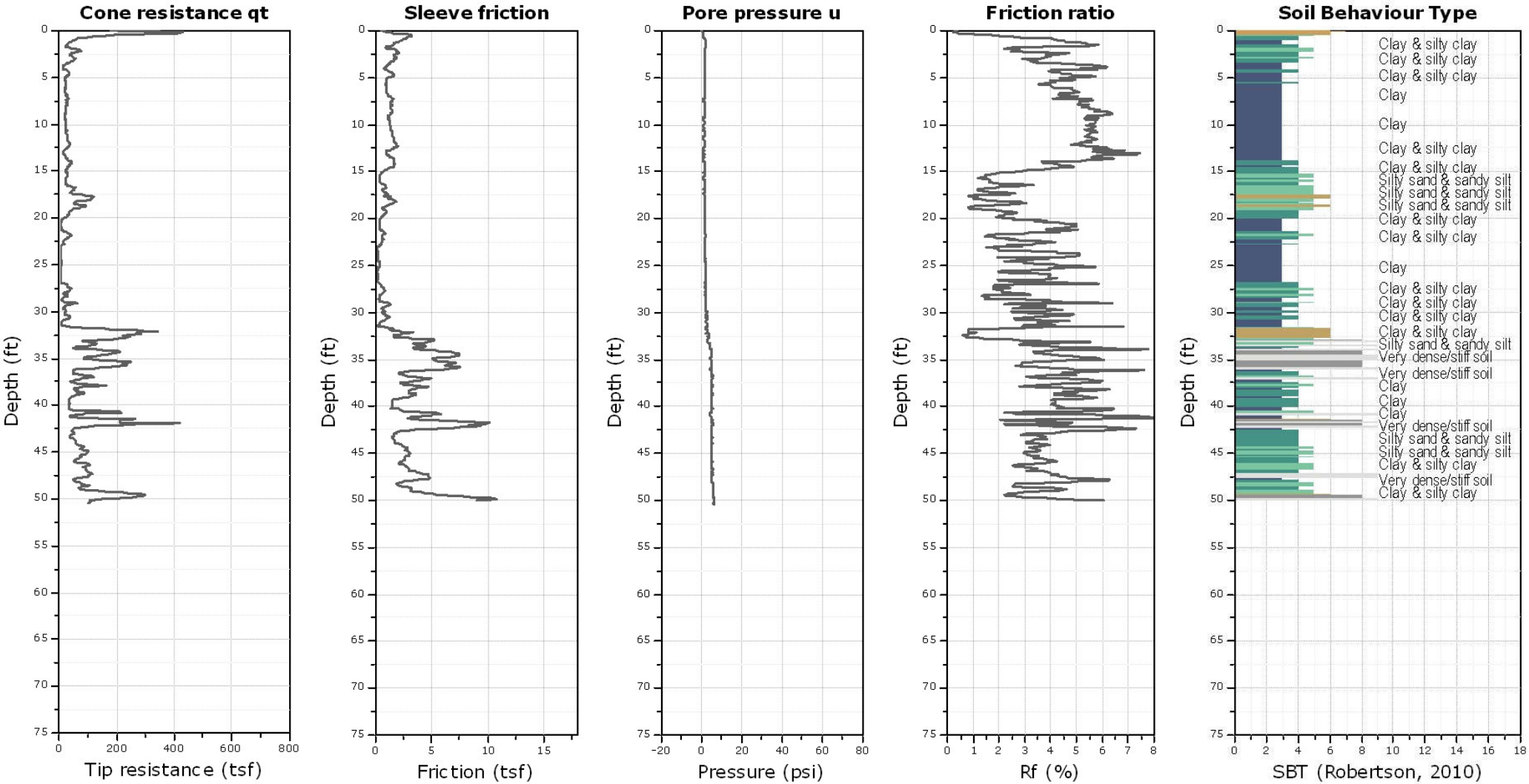



Kehoe Testing and Engineering
 714-901-7270
 rich@kehoetesting.com
 www.kehoetesting.com

Project: Converse Consultants/Mount San Antonio College (Lot R)
Location: 1100 N. Grand Ave Walnut, CA

CPT-16

Total depth: 75.22 ft, Date: 9/7/2017

Cone Type: Vertek

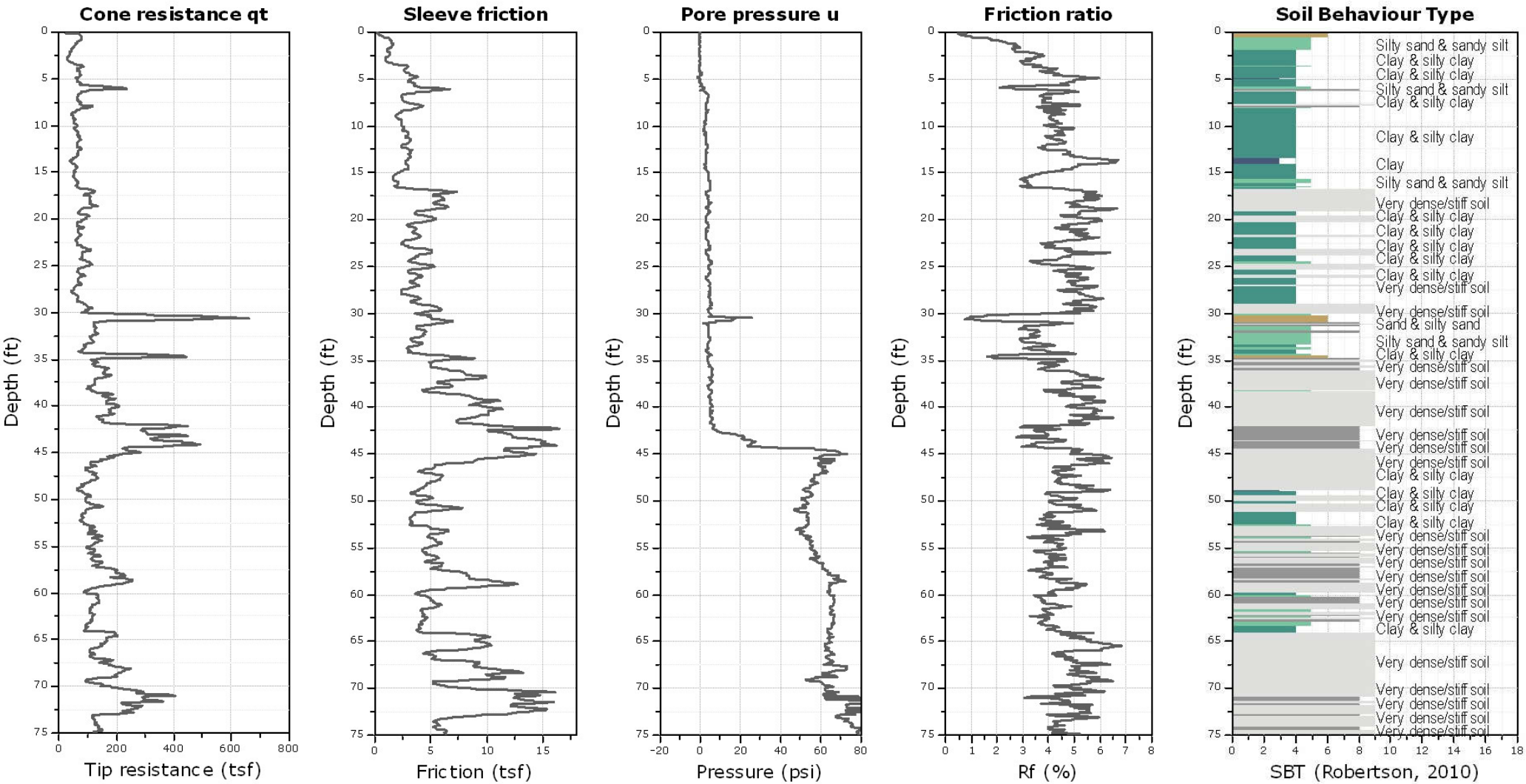



Kehoe Testing and Engineering
 714-901-7270
 rich@kehoetesting.com
 www.kehoetesting.com

Project: Converse Consultants/Mount San Antonio College (Lot R)
Location: 1100 N. Grand Ave Walnut, CA

CPT-17





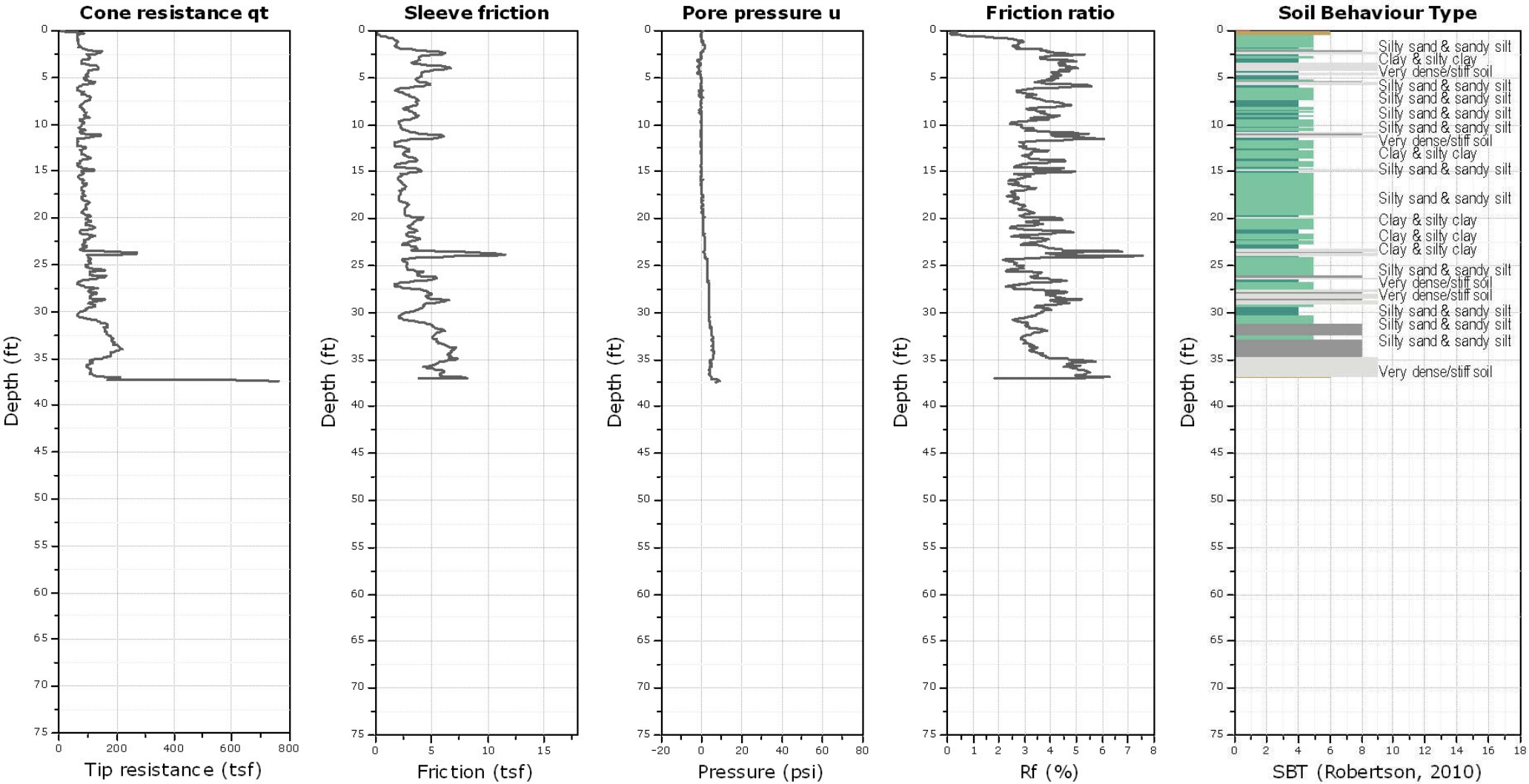

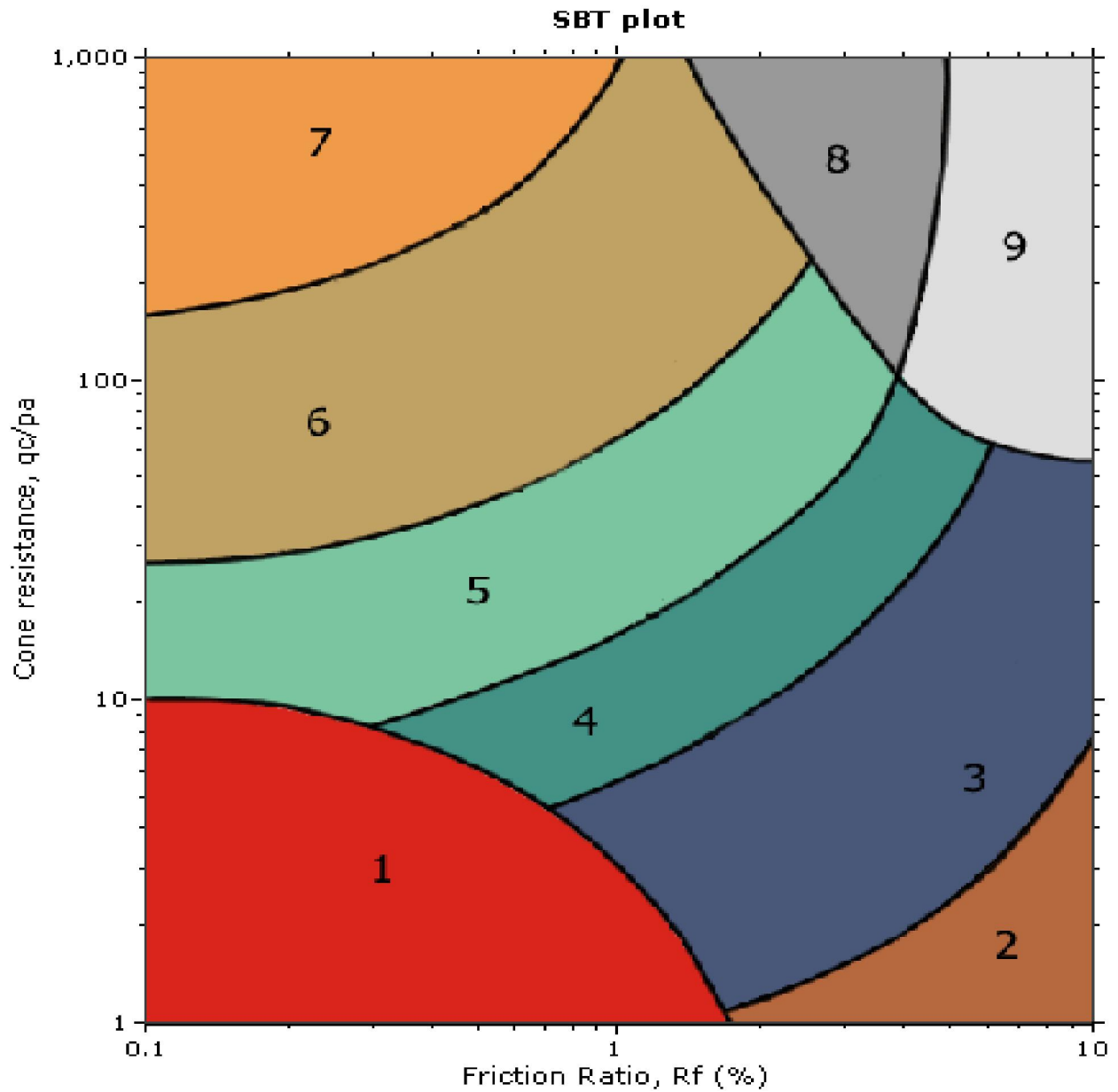

Total depth: 37.41 ft, Date: 9/7/2017

Cone Type: Vertek





SBT legend

- | | | |
|---|--|---|
|  1. Sensitive fine grained |  4. Clayey silt to silty clay |  7. Gravely sand to sand |
|  2. Organic material |  5. Silty sand to sandy silt |  8. Very stiff sand to clayey sand |
|  3. Clay to silty clay |  6. Clean sand to silty sand |  9. Very stiff fine grained |

Depth (ft)	CPT-1 In situ data				Basic output data																		
	qc (tsf)	fs (tsf)	u (psi)	Other	qt (tsf)	Rf(%)	SBT	Ic SBT	\bar{a} (pcf)	ϕ, v (tsf)	u0 (tsf)	ϕ', v_0 (tsf)	Qt1	Fr (%)	Bq	SBTn	n	Cn	Ic	Qtn	U2	(B)	Mod. SBTn
1	77.38	1.67	0.45	-1.4	77.39	2.16	5	2.23	124.63	0.06	0	0.06	1240	2.16	0	8	0.55	4.69	1.81	342.57	0.52	43.51	7
2	41.46	2.09	0.19	-1.55	41.46	5.04	4	2.69	124.74	0.12	0	0.12	331.29	5.05	0	9	0.72	4.68	2.27	182.74	0.11	19.4	3
3	26	1.57	0.19	-1.4	26	6.02	3	2.89	121.5	0.19	0	0.19	139.29	6.07	0	9	0.81	4.06	2.49	99.19	0.07	16.25	3
4	54.93	2.61	1.31	-1.31	54.94	4.75	4	2.58	127.06	0.25	0	0.25	219.72	4.77	0	9	0.74	2.9	2.3	150.06	0.38	20.36	3
5	77.17	3.65	1.77	-1.88	77.19	4.73	4	2.48	130.36	0.31	0	0.31	244.72	4.75	0	9	0.73	2.41	2.26	175.26	0.41	20.51	3
6	73.73	2.19	2.03	-2.05	73.75	2.97	5	2.35	126.51	0.38	0	0.38	194.39	2.99	0	5	0.69	2.03	2.15	140.71	0.39	30.72	5
7	105.89	2.61	2.41	-2.17	105.92	2.46	5	2.18	128.67	0.44	0	0.44	238.73	2.48	0	5	0.64	1.75	2.03	174.8	0.39	36.76	7
8	108.6	3.24	2.67	-2.29	108.64	2.98	5	2.24	130.3	0.51	0	0.51	213.36	2.99	0	8	0.68	1.64	2.1	168.01	0.38	31.07	5
9	127.4	3.24	2.8	-2.43	127.44	2.54	5	2.14	130.69	0.57	0	0.57	221.71	2.55	0	5	0.65	1.49	2.03	178.91	0.35	35.88	7
10	142.96	4.07	3	-2.55	143	2.85	5	2.14	132.65	0.64	0	0.64	222.94	2.86	0	8	0.66	1.4	2.06	188.2	0.34	32.58	7
11	123.85	4.18	2.99	-2.68	123.89	3.37	5	2.24	132.49	0.7	0	0.7	174.76	3.39	0	8	0.71	1.33	2.17	155.29	0.31	27.71	5
12	82.6	2.72	3.19	-2.48	82.64	3.29	5	2.35	128.35	0.77	0	0.77	106.46	3.32	0	5	0.76	1.27	2.28	98.49	0.3	27.35	5
13	103.91	4.39	2.99	-2.57	103.94	4.22	9	2.36	132.42	0.84	0	0.84	123.47	4.25	0	9	0.77	1.2	2.32	117.02	0.26	22.37	5
14	97.53	3.97	2.8	-2.5	97.57	4.07	4	2.37	131.53	0.9	0	0.9	107.3	4.11	0	9	0.78	1.13	2.34	103.64	0.22	22.94	5
15	119.05	2.82	2.9	-2.22	119.08	2.37	5	2.13	129.51	0.97	0	0.97	122.31	2.39	0	5	0.7	1.07	2.12	119.04	0.22	36.44	7
16	97.95	3.03	2.83	-2.2	97.99	3.09	5	2.28	129.56	1.03	0	1.03	94.08	3.12	0	5	0.77	1.02	2.28	93.51	0.2	28.59	5
17	131.89	2.72	2.99	-2.63	131.93	2.06	5	2.06	129.49	1.1	0	1.1	119.45	2.08	0	5	0.69	0.98	2.07	120.73	0.2	40.78	7
18	78.11	2.92	2.9	-2.92	78.15	3.74	4	2.4	128.75	1.16	0	1.16	66.4	3.8	0	4	0.83	0.93	2.44	67.42	0.18	23.74	5
19	112.05	2.51	2.99	-3.32	112.09	2.24	5	2.13	128.5	1.22	0	1.22	90.59	2.26	0	5	0.74	0.9	2.17	94.14	0.18	36.82	7
20	80.2	2.61	2.8	-3.86	80.23	3.25	5	2.35	127.99	1.29	0	1.29	61.3	3.31	0	4	0.83	0.85	2.41	63.39	0.16	26.25	5
21	90.85	3.13	2.99	-3.88	90.89	3.45	5	2.33	129.63	1.35	0	1.35	66.19	3.5	0	4	0.83	0.82	2.4	69.02	0.16	25.37	5
22	198.2	4.28	3.09	-4.04	198.24	2.16	6	1.96	133.81	1.42	0	1.42	138.64	2.18	0	5	0.69	0.82	2.02	151.98	0.16	40.43	7
23	152.05	3.76	3.38	-4.3	152.09	2.47	5	2.08	132.22	1.49	0	1.49	101.37	2.5	0	5	0.74	0.78	2.16	110.65	0.16	34.85	7
24	136.38	3.97	3.67	-4.24	136.43	2.91	5	2.16	132.35	1.55	0	1.55	86.91	2.94	0	5	0.78	0.74	2.26	94.45	0.17	30.02	5
25	110.59	4.18	3.38	-4.02	110.63	3.78	5	2.31	132.21	1.62	0	1.62	67.38	3.83	0	4	0.85	0.7	2.42	71.85	0.15	23.7	5
26	77.07	3.45	3.28	-3.89	77.11	4.47	4	2.47	129.92	1.68	0	1.68	44.82	4.57	0	4	0.92	0.65	2.6	46.47	0.14	20	3
27	115.71	4.39	3.28	-4.28	115.75	3.79	8	2.3	132.68	1.75	0	1.75	65.17	3.85	0	4	0.86	0.65	2.43	69.97	0.14	23.58	5
28	163.64	3.45	3.57	-4.16	163.68	2.11	5	2.01	131.76	1.82	0	1.82	89.18	2.13	0	5	0.75	0.67	2.13	102.24	0.14	39.02	7
29	139.93	3.86	3.57	-3.01	139.98	2.76	5	2.14	132.21	1.88	0	1.88	73.41	2.8	0	5	0.81	0.63	2.28	81.99	0.14	30.72	5
30	195.38	4.18	3.57	-2.19	195.43	2.14	6	1.96	133.6	1.95	0	1.95	99.32	2.16	0	5	0.74	0.64	2.09	116.39	0.13	39.34	7
31	189.64	4.49	3.58	-1.31	189.68	2.37	5	2.01	134.05	2.02	0	2.02	93.13	2.39	0	5	0.76	0.61	2.15	108.44	0.13	35.95	7
32	116.44	3.76	3.57	-0.47	116.48	3.23	5	2.24	131.56	2.08	0	2.08	54.97	3.29	0	4	0.87	0.55	2.43	59.91	0.12	26.2	5
33	127.82	3.13	3.57	0.36	127.86	2.45	5	2.12	130.46	2.15	0	2.15	58.58	2.49	0	5	0.83	0.56	2.31	65.98	0.12	32.41	7
34	126.46	3.34	3.58	0.95	126.51	2.64	5	2.15	130.9	2.21	0	2.21	56.2	2.69	0	5	0.85	0.53	2.35	62.8	0.12	30.48	5
35	128.34	3.86	3.38	1.86	128.38	3.01	5	2.19	132	2.28	0	2.28	55.37	3.06	0	5	0.87	0.51	2.4	61.12	0.11	27.64	5
36	152.25	4.18	3.48	2.74	152.3	2.74	5	2.11	132.99	2.34	0	2.34	63.97	2.79	0	5	0.84	0.51	2.32	72.47	0.11	30.33	5
37	162.18	4.39	3.73	4	162.22	2.7	5	2.09	133.5	2.41	0	2.41	66.29	2.74	0	5	0.84	0.5	2.3	75.64	0.11	30.85	5
38	203.84	4.91	4.15	4.21	203.89	2.41	5	1.99	134.88	2.48	0	2.48	81.28	2.44	0	5	0.8	0.51	2.19	96.25	0.12	34.89	7
39	157.58	5.85	3.87	5.11	157.63	3.71	8	2.21	135.54	2.55	0	2.55	60.91	3.77	0	4	0.9	0.45	2.44	66.52	0.11	23.85	5
40	145.88	5.12	3.96	5.86	145.93	3.51	8	2.21	134.37	2.61	0	2.61	54.85	3.57	0	4	0.91	0.44	2.45	59.56	0.11	24.61	5
41	155.6	4.8	3.99	6.23	155.65	3.09	5	2.15	134.07	2.68	0	2.68	57.07	3.14	0	5	0.89	0.44	2.39	63.27	0.11	27.27	5
42	175.02	5.01	4.05	6.71	175.07	2.86	5	2.09	134.66	2.75	0	2.75	62.72	2.91	0	5	0.87	0.44	2.34	71.01	0.11	29.29	5
43	256.26	0	4.54	7.01	256.32	0	0	0	87.36	2.79	0	2.79	90.83	0	0	0	1	0.38	4.06	90.83	0.12	144.05	0

Depth (ft)	CPT-2 In situ data						Basic output data																
	qc (tsf)	fs (tsf)	u (psi)	Other	qt (tsf)	Rf(%)	SBT	Ic SBT	\bar{a} (pcf)	\dot{o},v (tsf)	u0 (tsf)	\dot{o}',vo (tsf)	Qt1	Fr (%)	Bq	SBTn	n	Cn	Ic	Qtn	U2	(B)	Mod. SBTn
1	60.46	2.3	-0.16	1.18	60.46	3.8	4	2.48	126.36	0.06	0	0.06	955.32	3.8	0	8	0.63	5.87	2.03	335.27	-0.19	25.67	5
2	31.85	1.57	-0.01	1.32	31.85	4.92	3	2.76	122	0.12	0	0.12	255.32	4.94	0	9	0.74	4.87	2.32	145.97	-0.01	19.73	3
3	20.47	1.25	0	1.48	20.47	6.12	3	2.97	119.29	0.18	0	0.18	110.39	6.18	0	9	0.83	4.25	2.54	81.53	0	15.95	3
4	25.48	1.36	-0.2	1.49	25.48	5.33	3	2.85	120.41	0.24	0	0.24	103.42	5.38	0	9	0.82	3.31	2.51	78.9	-0.06	17.98	3
5	61.72	1.57	-0.02	1.83	61.72	2.54	5	2.35	123.61	0.31	0	0.31	200.8	2.55	0	5	0.67	2.29	2.11	133	0	34.94	7
6	60.99	2.51	0.97	1.86	61	4.11	4	2.51	127.02	0.37	0	0.37	164.13	4.13	0	9	0.74	2.18	2.29	124.95	0.19	23.01	5
7	69.65	2.51	1.02	1.87	69.67	3.6	4	2.43	127.34	0.43	0	0.43	159.85	3.62	0	8	0.73	1.91	2.25	125.17	0.17	25.84	5
8	85.11	3.34	1.74	1.31	85.13	3.93	4	2.4	129.94	0.5	0	0.5	169.98	3.95	0	8	0.73	1.73	2.25	138.74	0.25	24.08	5
9	74.35	2.92	1.74	1.14	74.37	3.93	4	2.43	128.63	0.56	0	0.56	131.28	3.96	0	8	0.76	1.61	2.31	112.45	0.22	23.76	5
10	73.52	3.34	1.83	0.92	73.54	4.54	4	2.48	129.58	0.63	0	0.63	116.27	4.58	0	9	0.79	1.51	2.38	103.92	0.21	20.85	3
11	79.47	3.13	1.93	0.73	79.49	3.94	4	2.42	129.3	0.69	0	0.69	113.91	3.98	0	9	0.77	1.39	2.33	103.32	0.2	23.57	5
12	70.28	2.61	1.9	0.83	70.3	3.71	4	2.43	127.67	0.76	0	0.76	92.04	3.75	0	4	0.79	1.3	2.36	85.65	0.18	24.43	5
13	113.93	4.07	1.84	0.71	113.95	3.57	5	2.28	132.1	0.82	0	0.82	137.71	3.6	0	8	0.74	1.21	2.24	128.98	0.16	26.01	5
14	93.04	4.8	2.12	0.38	93.07	5.16	9	2.46	132.81	0.89	0	0.89	103.81	5.21	0	9	0.82	1.15	2.43	100.55	0.17	18.61	3
15	91.37	3.03	2.22	0.51	91.4	3.31	5	2.32	129.39	0.95	0	0.95	94.94	3.35	0	5	0.77	1.08	2.3	92.7	0.17	27	5
16	103.17	3.03	2.12	0.56	103.2	2.93	5	2.25	129.69	1.02	0	1.02	100.41	2.96	0	5	0.75	1.03	2.24	99.45	0.15	30.01	5
17	144.01	4.49	2.12	0.61	144.03	3.12	5	2.17	133.38	1.08	0	1.08	131.83	3.14	0	5	0.73	0.98	2.18	132.69	0.14	29.31	5
18	98.06	3.97	2.12	0.67	98.08	4.05	4	2.37	131.54	1.15	0	1.15	84.29	4.09	0	4	0.82	0.93	2.39	85.6	0.13	22.74	5
19	62.24	2.51	2.03	0.59	62.26	4.03	4	2.49	127.07	1.21	0	1.21	50.31	4.11	0	4	0.88	0.89	2.54	51.17	0.12	21.84	3
20	73.93	3.86	2.12	0.34	73.96	5.22	9	2.53	130.66	1.28	0	1.28	56.83	5.32	0	4	0.9	0.84	2.59	57.96	0.12	17.97	3
21	77.9	4.07	2.12	-0.04	77.93	5.23	9	2.52	131.17	1.34	0	1.34	56.96	5.32	0	4	0.9	0.81	2.59	58.36	0.11	17.97	3
22	77.07	4.18	2.13	-0.34	77.09	5.42	9	2.53	131.33	1.41	0	1.41	53.67	5.52	0	4	0.91	0.77	2.62	55.02	0.11	17.4	3
23	74.25	5.64	2.16	-0.49	74.27	7.59	9	2.65	133.43	1.48	0	1.48	49.3	7.75	0	3	0.97	0.72	2.76	49.8	0.11	13.12	3
24	78.32	3.13	2.22	-0.51	78.35	4	4	2.43	129.26	1.54	0	1.54	49.83	4.08	0	4	0.89	0.72	2.54	51.95	0.1	21.98	3
25	78.84	3.34	2.18	-0.84	78.87	4.24	4	2.44	129.75	1.61	0	1.61	48.1	4.33	0	4	0.9	0.69	2.56	50.08	0.1	20.96	3
26	96.28	3.03	2.22	-1.02	96.31	3.14	5	2.29	129.52	1.67	0	1.67	56.63	3.2	0	5	0.85	0.68	2.41	60.69	0.1	26.76	5
27	85.42	2.61	2.22	-1.15	85.45	3.06	5	2.31	128.14	1.74	0	1.74	48.24	3.12	0	4	0.87	0.65	2.46	51.5	0.09	26.67	5
28	93.78	3.03	2.32	-1.28	93.8	3.23	5	2.3	129.45	1.8	0	1.8	51.12	3.29	0	4	0.87	0.63	2.45	54.77	0.09	25.88	5
29	67.15	2.92	2.22	-1.27	67.17	4.35	4	2.5	128.38	1.86	0	1.86	35.04	4.48	0	4	0.96	0.58	2.68	35.87	0.09	19.89	3
30	65.48	2.3	2.32	-1.23	65.5	3.51	4	2.44	126.56	1.93	0	1.93	32.99	3.61	0	4	0.94	0.57	2.63	34.13	0.09	22.83	5
31	69.65	2.09	2.32	-1.13	69.68	3	5	2.37	126.01	1.99	0	1.99	34.01	3.09	0	4	0.92	0.56	2.57	35.7	0.08	25.37	5
32	54.82	2.4	2.32	-1.03	54.85	4.38	4	2.56	126.45	2.05	0	2.05	25.71	4.55	0	3	1	0.52	2.79	25.71	0.08	19.1	3
33	53.05	2.09	2.17	-1.11	53.08	3.94	4	2.53	125.35	2.12	0	2.12	24.08	4.1	0	3	1	0.5	2.78	24.08	0.07	20.2	3
34	109.02	3.34	2.22	-1.18	109.05	3.06	5	2.24	130.54	2.18	0	2.18	48.99	3.13	0	4	0.89	0.53	2.45	53.21	0.07	26.74	5
35	82.39	4.7	2.32	-1.48	82.42	5.7	9	2.53	132.35	2.25	0	2.25	35.67	5.86	0	3	1	0.47	2.76	35.67	0.07	16.36	3
36	180.35	4.39	2.32	-0.63	180.37	2.43	5	2.03	133.76	2.31	0	2.31	76.93	2.46	0	5	0.8	0.53	2.21	89.77	0.07	34.27	7
37	99.83	4.07	2.49	-0.36	99.86	4.08	9	2.36	131.78	2.38	0	2.38	40.95	4.18	0	4	0.96	0.46	2.6	42.47	0.08	21.21	3
38	86.99	4.07	2.99	-0.41	87.02	4.68	9	2.45	131.44	2.45	0	2.45	34.58	4.82	0	4	1	0.43	2.71	34.62	0.09	18.85	3
39	136.49	3.97	3.18	-0.67	136.53	2.91	5	2.16	132.35	2.51	0	2.51	53.34	2.96	0	5	0.88	0.47	2.4	59.06	0.09	28.2	5
40	181.18	5.22	3.96	-0.74	181.23	2.88	5	2.09	135.05	2.58	0	2.58	69.25	2.92	0	5	0.85	0.47	2.3	79.14	0.11	29.59	5
41	135.44	5.53	4.15	-1.05	135.49	4.08	8	2.28	134.76	2.65	0	2.65	50.18	4.17	0	4	0.94	0.42	2.54	52.92	0.11	21.66	3
42	171.16	5.43	3.96	-0.75	171.2	3.17	8	2.13	135.19	2.71	0	2.71	62.06	3.22	0	5	0.88	0.43	2.38	69.27	0.1	27.03	5
43	194.03	6.37	4.54	-0.34	194.08	3.28	8	2.11	136.67	2.78	0	2.78	68.73	3.33	0	5	0.88	0.43	2.35	77.32	0.12	26.67	5
44	136.07	5.43	4.18	-0.5	136.12	3.99	8	2.27	134.64	2.85	0	2.85	46.75	4.07	0	4	0.96	0.39	2.55	48.72	0.11	21.87	3
45	132.94	4.49	4.44	-0.52	132.99	3.38	5	2.22	133.19	2.92	0	2.92	44.59	3.45	0	4	0.95	0.38	2.51	47.08	0.11	24.55	5
46	147.66	4.91	4.25	-0.38	147.71	3.32	8	2.19	134.1	2.98	0	2.98	48.5	3.39	0	4	0.94	0.38	2.48	51.8	0.1	25.16	5
47	161.13	5.33	4.34	-0.6	161.18	3.3	8	2.16	134.91	3.05	0	3.05	51.82	3.37	0	4	0.93	0.37	2.45	55.79	0.1	25.51	5
48	155.18	5.22	4.32	-0.68	155.23	3.36	8	2.18	134.67	3.12	0	3.12	48.77	3.43	0	4	0.94	0.36	2.48	51.81	0.1	24.94	5
49	154.45	5.85	4.34	-0.58	154.5	3.79	8	2.22	135.49	3.19	0	3.19	47.48	3.86	0	4	0.97	0.34	2.53	49.25	0.1	22.76	5
50	168.65	5.85	4.44	-0.53	168.7	3.47	8	2.17	135.7	3.25	0	3.25	50.84	3.53	0	4	0.95	0.34	2.48	53.8	0.1	24.52	5
51	164.79	5.85	4.44	-0.46	164.84	3.55	8	2.18	135.64	3.32	0	3.32	48.61	3.62	0	4	0.96	0.33	2.51	50.76	0.1	23.94	5
52	109.23	5.64	4.25	-0.55	109.28	5.16	9	2.42	134.38	3.39	0	3.39	31.24	5.33	0	3	1	0.31	2.77	31.24	0.09	17.45	3
53	114.03	4.7	3.96	-0.5	114.08	4.12	9	2.33	133.15	3.46	0	3.46	32.01	4.25	0	4	1	0.31	2.7	32.01	0.08	20.4	3
54	111.84	4.59	4.25	-0.23	111.89	4.11	9	2.33	132.94	3.52	0	3.52	30.76	4.24	0	4	1	0.3	2.71	30.76	0.09	20.34	3
55	128.55	5.22	3.97	0.04	128.6	4.06	9	2.29	134.21	3.59	0	3.59	34.82	4.18	0	4	1	0.29	2.67	34.82	0.08	20.8	3
56	181.29	6.58	4.25	0.06	181.34	3.63	8	2.17	136.74	3.66	0	3.66	48.57	3.7	0	4	0.98	0.3	2.52	49.6	0.08	23.5	5
57	130.43	6.27	3.97	0.21	130.48	4.8	9	2.35	135.58	3.73	0	3.73	34.02	4.94	0	3	1	0.28	2.72	34.02	0.08	18.48	3
58	142.33	5.43	4.19	0.51	142.39	3.81	8	2.25	134.75	3.79	0</												

Depth (ft)	CPT-3 In situ data					Basic output data																	
	qc (tsf)	fs (tsf)	u (psi)	Other	qt (tsf)	Rf(%)	SBT	Ic.SBT	\bar{a} (pcf)	\acute{o},v (tsf)	u0 (tsf)	$\acute{o}',v\acute{o}$ (tsf)	Qt1	Fr (%)	Bq	SBTn	n	Cn	Ic	Qtn	U2	l(B)	Mod. SBTn
1	331.66	3.55	0.73	1.41	331.67	1.07	6	1.58	133.7	0.07	0	0.07	4957.2	1.07	0	6	0.37	2.77	1.36	868.65	0.78	87.86	7
2	40.52	2.4	0.39	3.66	40.52	5.93	3	2.74	125.71	0.13	0	0.13	311.21	5.95	0	9	0.74	4.76	2.33	181.64	0.21	16.66	3
3	118.73	3.97	0.28	3.71	118.74	3.34	5	2.25	132.01	0.2	0	0.2	605.98	3.35	0	8	0.62	2.84	1.99	318.18	0.1	28.91	5
4	102.76	5.74	1.26	3.69	102.77	5.59	9	2.46	134.36	0.26	0	0.26	390	5.6	0	9	0.71	2.7	2.23	261.33	0.34	17.69	3
5	126.15	5.53	0.7	3.71	126.16	4.39	9	2.33	134.59	0.33	0	0.33	381.08	4.4	0	8	0.68	2.21	2.14	262.62	0.15	22.25	5
6	169.9	5.64	1.45	3.6	169.92	3.32	8	2.15	135.45	0.4	0	0.4	425.98	3.33	0	8	0.63	1.86	2.01	297.59	0.26	29.02	5
7	130.74	5.95	1.84	3.59	130.77	4.55	9	2.33	135.21	0.47	0	0.47	279.85	4.57	0	9	0.71	1.79	2.19	220.03	0.28	21.4	3
8	97.01	5.33	1.84	4.09	97.04	5.49	9	2.47	133.67	0.53	0	0.53	181.31	5.52	0	9	0.77	1.69	2.34	154.57	0.25	17.83	3
9	139.41	5.43	1.86	4.54	139.43	3.89	8	2.26	134.69	0.6	0	0.6	231.52	3.91	0	8	0.7	1.49	2.16	195.48	0.22	24.62	5
10	192.15	9.4	1.74	4.62	192.17	4.89	9	2.26	137.28	0.67	0	0.67	286.53	4.91	0	9	0.72	1.39	2.19	251.47	0.19	20.05	3
11	229.01	11.9	2.8	5.74	229.04	5.2	9	2.24	137.28	0.74	0	0.74	309.77	5.21	0	9	0.72	1.3	2.19	279.91	0.27	18.95	3
12	148.91	7	4.02	6.1	148.96	4.7	9	2.31	136.71	0.81	0	0.81	183.95	4.72	0	9	0.75	1.23	2.26	171.81	0.36	20.63	3
13	151.63	6.16	4.16	6.25	151.68	4.06	8	2.25	135.82	0.87	0	0.87	172.71	4.09	0	8	0.74	1.15	2.22	164.21	0.34	23.51	5
14	138.05	5.74	3.87	6.37	138.1	4.16	9	2.28	135.08	0.94	0	0.94	145.8	4.19	0	8	0.76	1.09	2.27	141.7	0.3	22.87	5
15	157.06	4.28	3.38	6.49	157.1	2.73	5	2.1	133.25	1.01	0	1.01	154.94	2.74	0	5	0.7	1.03	2.1	152.66	0.24	33.28	7
16	115.18	4.7	3.29	6.39	115.22	4.08	9	2.32	133.17	1.07	0	1.07	106.28	4.12	0	9	0.79	0.99	2.33	106.61	0.22	22.91	5
17	134.5	5.33	3.38	6.25	134.54	3.96	8	2.27	134.47	1.14	0	1.14	116.88	3.99	0	8	0.78	0.94	2.29	118.87	0.21	23.66	5
18	123.54	5.12	3.58	5.94	123.58	4.14	9	2.31	133.97	1.21	0	1.21	101.29	4.18	0	9	0.8	0.9	2.35	104	0.21	22.58	5
19	186.72	5.43	3.96	5.91	186.76	2.91	8	2.08	135.41	1.28	0	1.28	145.38	2.93	0	5	0.72	0.87	2.12	153.26	0.22	31.48	5
20	219.3	6.58	4.1	5.8	219.35	3	8	2.05	137.2	1.34	0	1.34	162.14	3.02	0	8	0.71	0.84	2.1	173.68	0.22	30.92	5
21	202.48	9.4	4.35	5.64	202.54	4.64	9	2.23	137.28	1.41	0	1.41	142.32	4.67	0	9	0.79	0.8	2.29	151.29	0.22	20.76	3
22	188.6	8.88	4.45	5.44	188.65	4.71	9	2.25	137.28	1.48	0	1.48	126.3	4.74	0	9	0.8	0.76	2.32	134.89	0.22	20.42	3
23	175.33	6.16	4.64	5.21	175.39	3.51	8	2.16	136.18	1.55	0	1.55	112.17	3.54	0	8	0.78	0.74	2.25	122.02	0.22	26.27	5
24	179.09	6.68	4.64	4.98	179.15	3.73	8	2.18	136.82	1.62	0	1.62	109.71	3.76	0	8	0.79	0.71	2.27	119.82	0.21	24.91	5
25	185.04	9.5	4.87	4.95	185.1	5.13	9	2.29	137.28	1.69	0	1.69	108.73	5.18	0	9	0.84	0.68	2.39	117.15	0.21	18.78	3
26	234.33	9.61	5.18	5.09	234.4	4.1	8	2.15	137.28	1.76	0	1.76	132.51	4.13	0	8	0.79	0.67	2.25	147.31	0.21	23.19	5
27	217.73	7.83	4.84	5.14	217.79	3.6	8	2.12	137.28	1.82	0	1.82	118.38	3.63	0	8	0.79	0.65	2.23	132.99	0.19	25.89	5
28	161.13	8.67	5.27	4.9	161.2	5.38	9	2.34	137.28	1.89	0	1.89	84.16	5.44	0	9	0.88	0.6	2.47	90.12	0.2	17.87	3
29	256.89	8.67	4.62	4.55	256.95	3.37	8	2.06	137.28	1.96	0	1.96	130	3.4	0	8	0.77	0.62	2.18	149.58	0.17	27.59	5
30	183.79	0	5.11	4.49	183.85	0	0	0	87.36	2.01	0	2.01	90.69	0	0	0	1	0.53	4.06	90.69	0.18	143.84	0

Depth (ft)	CPT-4 In situ data				Basic output data																		
	qc (tsf)	fs (tsf)	u (psi)	Other	qt (tsf)	Rf(%)	SBT	Ic SBT	\bar{a} (pcf)	ϕ, v (tsf)	u0 (tsf)	ϕ', v_0 (tsf)	Qt1	Fr (%)	Bq	SBTn	n	Cn	Ic	Qtn	U2	(B)	Mod. SBTn
1	39.06	1.88	-0.1	1.87	39.05	4.81	4	2.69	123.83	0.06	0	0.06	629.37	4.82	0	9	0.68	6.96	2.18	256.67	-0.11	20.4	3
2	46.89	2.4	0.03	1.77	46.89	5.12	4	2.65	126.07	0.13	0	0.13	374.02	5.14	0	9	0.71	4.6	2.25	203.37	0.02	19.14	3
3	36.55	2.3	0.68	1.81	36.56	6.28	3	2.79	125.14	0.19	0	0.19	194.04	6.32	0	9	0.78	3.88	2.43	133.23	0.26	15.71	3
4	26.63	1.78	1.16	1.87	26.64	6.66	3	2.91	122.48	0.25	0	0.25	106.12	6.73	0	9	0.84	3.37	2.57	84.02	0.34	14.8	3
5	22.45	1.25	0.39	1.9	22.46	5.58	3	2.91	119.51	0.31	0	0.31	71.79	5.66	0	4	0.85	2.87	2.6	59.99	0.09	17.09	3
6	26.63	1.25	0	1.97	26.63	4.71	3	2.8	119.93	0.37	0	0.37	71.26	4.77	0	4	0.84	2.42	2.54	59.95	0	19.64	3
7	17.65	0.94	-0.15	1.99	17.65	5.33	3	2.97	116.82	0.43	0	0.43	40.33	5.46	0	3	0.91	2.28	2.73	37.14	-0.03	17.29	3
8	23.5	1.46	0	2.02	23.5	6.22	3	2.93	120.75	0.49	0	0.49	47.23	6.35	0	3	0.91	2.03	2.72	44.11	0	15.45	3
9	52.94	2.82	0	2.23	52.94	5.33	4	2.63	127.54	0.55	0	0.55	95.09	5.38	0	9	0.82	1.71	2.49	84.74	0	18.01	3
10	56.7	2.72	0.29	2.37	56.71	4.79	4	2.58	127.43	0.61	0	0.61	91.25	4.84	0	9	0.82	1.56	2.46	82.55	0.03	19.71	3
11	68.4	3.03	0.39	2.44	68.4	4.43	4	2.5	128.68	0.68	0	0.68	99.72	4.47	0	9	0.8	1.42	2.4	91.2	0.04	21.18	3
12	135.55	3.86	0.58	2.72	135.55	2.85	5	2.16	132.14	0.75	0	0.75	180.89	2.87	0	5	0.68	1.27	2.1	161.96	0.06	32.19	7
13	111.63	4.28	1.26	2.56	111.65	3.83	8	2.31	132.41	0.81	0	0.81	136.62	3.86	0	8	0.75	1.22	2.26	127.87	0.11	24.45	5
14	5.12	4.39	-0.03	2.32	5.12	85.72	2	4.21	125.07	0.87	0	0.87	4.86	103.38	0	2	1	1.21	4.06	4.86	0	2.6	1
15	181.81	5.33	0.74	2.84	181.82	2.93	5	2.09	135.2	0.94	0	0.94	192.12	2.94	0	8	0.68	1.08	2.07	185.17	0.06	31.72	5
16	146.09	7.21	2.1	2.84	146.12	4.93	9	2.33	136.88	1.01	0	1.01	143.68	4.97	0	9	0.78	1.04	2.32	142.24	0.15	19.61	3
17	236.84	7.73	2.79	2.21	236.88	3.26	8	2.06	137.28	1.08	0	1.08	218.6	3.28	0	8	0.69	0.99	2.07	219.91	0.19	29.08	5
18	127.82	6.58	3.1	1.81	127.86	5.15	9	2.38	135.89	1.15	0	1.15	110.53	5.19	0	9	0.82	0.94	2.4	112.14	0.19	18.73	3
19	166.35	6.47	3	1.93	166.39	3.89	8	2.21	136.41	1.21	0	1.21	135.98	3.92	0	8	0.76	0.9	2.24	140.51	0.18	24.25	5
20	121.97	4.91	4.83	1.8	122.03	4.02	9	2.3	133.63	1.28	0	1.28	94.22	4.06	0	9	0.81	0.86	2.35	97.77	0.27	23.06	5
21	112.05	5.64	3.87	1.23	112.1	5.03	9	2.4	134.44	1.35	0	1.35	82.11	5.09	0	9	0.85	0.81	2.47	85.08	0.21	18.89	3
22	160.3	7.21	3.92	0.99	160.34	4.49	9	2.27	137.1	1.42	0	1.42	112.13	4.53	0	9	0.81	0.79	2.34	118.59	0.2	21.16	3
23	138.37	6.37	4.66	1.16	138.42	4.6	9	2.32	135.84	1.49	0	1.49	92.21	4.65	0	9	0.83	0.75	2.4	97.53	0.23	20.53	3
24	184.11	5.01	3.96	1.16	184.15	2.72	5	2.06	134.79	1.55	0	1.55	117.61	2.75	0	5	0.74	0.75	2.14	129.96	0.18	32.8	7
25	174.81	6.58	4.93	1.38	174.87	3.76	8	2.19	136.65	1.62	0	1.62	106.88	3.8	0	8	0.8	0.71	2.28	116.58	0.22	24.69	5
26	210.42	8.88	6.04	1.6	210.49	4.22	8	2.19	137.28	1.69	0	1.69	123.58	4.25	0	9	0.8	0.69	2.28	135.74	0.26	22.52	5
27	204.36	9.09	8.72	1.57	204.47	4.44	9	2.21	137.28	1.76	0	1.76	115.29	4.48	0	9	0.82	0.66	2.32	126.54	0.36	21.43	3
28	134.29	7.52	9.63	1.51	134.41	5.59	9	2.4	136.99	1.83	0	1.83	72.58	5.67	0.01	9	0.9	0.61	2.53	76.61	0.38	17.17	3
29	209.69	7.83	10.05	0.97	209.81	3.73	8	2.14	137.28	1.9	0	1.9	109.7	3.77	0	8	0.8	0.63	2.26	123.09	0.38	24.94	5
30	326.23	8.77	9.94	1.06	326.35	2.69	8	1.92	137.28	1.96	0	1.96	165.17	2.7	0	5	0.72	0.64	2.03	196.96	0.36	34.34	7
31	194.76	8.98	15.37	0.89	194.94	4.61	9	2.24	137.28	2.03	0	2.03	94.91	4.66	0.01	9	0.85	0.57	2.38	104.4	0.54	20.57	3
32	163.01	6.79	15.54	0.59	163.2	4.16	8	2.24	136.71	2.1	0	2.1	76.67	4.21	0.01	4	0.87	0.55	2.41	84.01	0.53	22.17	5
33	344.82	6.47	17.98	0.41	345.04	1.88	6	1.77	137.28	2.17	0	2.17	158.04	1.89	0	6	0.68	0.62	1.9	199.39	0.6	46.89	7
34	298.77	8.98	17.49	-0.06	298.98	3	8	1.98	137.28	2.24	0	2.24	132.58	3.03	0	5	0.76	0.56	2.12	158.12	0.56	30.65	5
35	161.97	11.8	20.78	-0.38	162.22	7.27	9	2.45	137.28	2.31	0	2.31	69.32	7.38	0.01	9	0.97	0.47	2.64	71.21	0.65	13.64	3
36	231.93	13.47	21.19	-0.93	232.19	5.8	9	2.28	137.28	2.38	0	2.38	96.74	5.86	0.01	9	0.9	0.48	2.46	104.87	0.64	16.78	3
37	308.48	7.94	23.53	-1.38	308.77	2.57	8	1.91	137.28	2.44	0	2.44	125.32	2.59	0.01	5	0.76	0.53	2.08	153.58	0.69	34.96	7
38	157.69	6.58	24.11	-1.9	157.98	4.16	8	2.25	136.4	2.51	0	2.51	61.88	4.23	0.01	4	0.91	0.45	2.47	66.79	0.69	21.78	3
39	290.2	6.37	30.73	-2.3	290.58	2.19	6	1.87	137.28	2.58	0	2.58	111.58	2.21	0.01	5	0.75	0.51	2.05	138.97	0.86	39.47	7
40	152.25	6.37	26.96	-2.71	152.58	4.17	8	2.26	136.08	2.65	0	2.65	56.6	4.25	0.01	4	0.93	0.43	2.5	60.36	0.73	21.55	3
41	107.66	4.7	25.36	-2.85	107.97	4.35	9	2.36	133.01	2.72	0	2.72	38.76	4.46	0.02	4	0.99	0.39	2.65	39.21	0.67	20.08	3
42	190.16	4.8	25.49	-2.91	190.47	2.52	5	2.03	134.56	2.78	0	2.78	67.44	2.56	0.01	5	0.85	0.44	2.27	78.35	0.66	32.66	7
43	122.18	5.53	25.8	-2.84	122.5	4.52	9	2.34	134.52	2.85	0	2.85	41.98	4.63	0.02	4	0.99	0.37	2.64	42.39	0.65	19.69	3
44	109.65	6.16	25.9	-2.82	109.97	5.6	9	2.45	135.04	2.92	0	2.92	36.69	5.76	0.02	3	1	0.36	2.75	36.69	0.64	16.61	3
45	151.94	6.47	27.35	-2.92	152.28	4.25	9	2.27	136.2	2.99	0	2.99	50	4.34	0.01	4	0.97	0.37	2.56	51.84	0.66	20.98	3
46	417.71	6.47	27.89	-3.3	418.05	1.55	6	1.66	137.28	3.05	0	3.05	135.87	1.56	0	6	0.7	0.48	1.85	186.57	0.66	54.44	7
47	448.93	8.56	27.6	-3.54	449.27	1.91	6	1.72	137.28	3.12	0	3.12	142.85	1.92	0	6	0.73	0.45	1.92	191.82	0.64	46.06	7
48	136.8	7.62	23.69	-3.63	137.09	5.56	9	2.39	137.14	3.19	0	3.19	41.95	5.69	0.01	3	1	0.33	2.7	41.95	0.53	16.82	3
49	196.32	6.79	29.02	-3.65	196.68	3.45	8	2.13	137.17	3.26	0	3.26	59.33	3.51	0.01	4	0.93	0.35	2.42	64.28	0.64	25.13	5
50	135.13	0	26.47	-3.65	135.45	0	0	0	87.36	3.3	0	3.3	40	0	0.01	0	1	0.32	4.06	40	0.58	71.43	0

Depth (ft)	CPT-5 In situ data					Basic output data																	
	qc (tsf)	fs (tsf)	u (psi)	Other	qt (tsf)	Rf(%)	SBT	Ic.SBT	\bar{a} (pcf)	\dot{o},v (tsf)	u0 (tsf)	\dot{o}',vo (tsf)	Qt1	Fr (%)	Bq	SBTn	n	Cn	Ic	Qtn	U2	l(B)	Mod. SBTn
1	67.04	1.88	1.34	-1.21	67.06	2.8	5	2.36	125.15	0.06	0	0.06	1070	2.81	0	8	0.59	5.23	1.92	331.39	1.54	34.15	7
2	202.8	2.61	0.58	-2.43	202.8	1.29	6	1.78	130.25	0.13	0	0.13	1586.1	1.29	0	6	0.44	2.56	1.54	489.62	0.32	71.31	7
3	47.51	2.3	-1.16	-3.35	47.5	4.84	4	2.63	125.77	0.19	0	0.19	248.34	4.86	0	9	0.73	3.51	2.29	156.74	-0.44	20.06	3
4	60.05	1.78	-1.29	-3.39	60.03	2.96	5	2.41	124.46	0.25	0	0.25	236.48	2.97	0	5	0.67	2.62	2.13	148.25	-0.37	31.01	5
5	51.38	1.78	-5.99	-3.45	51.3	3.46	4	2.51	124.08	0.31	0	0.31	161.95	3.48	-0.01	5	0.72	2.4	2.25	115.78	-1.37	26.59	5
6	22.56	1.67	-6.64	-3.37	22.48	7.43	3	2.99	121.62	0.38	0	0.38	58.82	7.56	-0.02	3	0.91	2.56	2.73	53.41	-1.27	13.38	3
7	18.9	1.25	-0.87	-3.02	18.89	6.63	3	3.01	119.09	0.44	0	0.44	42.4	6.79	0	3	0.93	2.28	2.78	39.81	-0.14	14.64	3
8	19.74	1.04	-0.15	-2.91	19.73	5.29	3	2.94	117.86	0.49	0	0.49	38.94	5.43	0	3	0.91	2.01	2.73	36.49	-0.02	17.34	3
9	22.56	1.25	-0.97	-2.77	22.54	5.56	3	2.91	119.52	0.55	0	0.55	39.7	5.7	0	3	0.92	1.81	2.74	37.69	-0.13	16.75	3
10	26.21	1.36	-0.46	-2.53	26.21	5.18	3	2.84	120.47	0.61	0	0.61	41.67	5.3	0	3	0.91	1.64	2.7	39.63	-0.05	17.71	3
11	27.36	1.25	0.14	-2.47	27.36	4.58	3	2.79	119.99	0.67	0	0.67	39.59	4.7	0	4	0.9	1.5	2.68	37.87	0.01	19.32	3
12	26.73	1.25	0.15	-2.37	26.74	4.69	3	2.8	119.94	0.73	0	0.73	35.41	4.82	0	4	0.92	1.4	2.71	34.38	0.01	18.83	3
13	41.25	2.19	0.65	-2.19	41.26	5.32	3	2.7	125.09	0.8	0	0.8	50.79	5.42	0	4	0.89	1.29	2.64	49.29	0.06	17.59	3
14	75.08	3.45	0.68	-2.19	75.09	4.59	4	2.48	129.86	0.86	0	0.86	86.16	4.64	0	9	0.82	1.18	2.44	83.05	0.06	20.43	3
15	70.49	3.55	-0.55	-2.16	70.48	5.04	4	2.53	129.92	0.93	0	0.93	75.07	5.1	0	9	0.85	1.12	2.51	73.58	-0.04	18.76	3
16	95.34	3.65	0.53	-2.31	95.35	3.83	4	2.36	130.87	0.99	0	0.99	95.12	3.87	0	4	0.79	1.05	2.35	93.84	0.04	23.95	5
17	83.02	3.76	-1.25	-2.35	83	4.53	4	2.45	130.74	1.06	0	1.06	77.5	4.59	0	4	0.84	1	2.46	77.49	-0.09	20.56	3
18	95.24	3.97	-1.57	-2.47	95.22	4.17	4	2.38	131.47	1.12	0	1.12	83.79	4.22	0	4	0.82	0.95	2.4	84.7	-0.1	22.17	5
19	90.75	4.8	0.68	-2.63	90.76	5.29	9	2.48	132.75	1.19	0	1.19	75.3	5.36	0	9	0.86	0.9	2.51	76.51	0.04	18.01	3
20	161.34	5.95	2.18	-2.98	161.37	3.69	8	2.2	135.72	1.26	0	1.26	127.34	3.72	0	8	0.76	0.88	2.24	132.65	0.13	25.33	5
21	219.4	7	1.6	-3.37	219.42	3.19	8	2.07	137.28	1.33	0	1.33	164.48	3.21	0	8	0.72	0.85	2.12	175.22	0.09	29.3	5
22	76.44	5.22	4.44	-3.43	76.5	6.83	9	2.61	132.94	1.39	0	1.39	53.93	6.95	0	3	0.94	0.77	2.69	54.8	0.23	14.37	3
23	136.49	4.49	4.15	-3.41	136.54	3.29	5	2.21	133.25	1.46	0	1.46	92.58	3.32	0	5	0.79	0.78	2.28	99.09	0.2	27.31	5
24	196.85	5.22	4.15	-3.88	196.9	2.65	5	2.04	135.25	1.53	0	1.53	127.97	2.67	0	5	0.73	0.77	2.11	141.49	0.2	33.8	7
25	73.31	4.18	12.94	-3.19	73.47	5.69	9	2.56	131.21	1.59	0	1.59	45.14	5.81	0.01	3	0.95	0.68	2.68	46.12	0.59	16.6	3
26	76.55	3.86	13.62	-3.85	76.71	5.04	9	2.51	130.75	1.66	0	1.66	45.28	5.15	0.01	4	0.93	0.66	2.64	46.62	0.59	18.26	3
27	63.39	3.13	14.04	-4.29	63.56	4.93	4	2.55	128.75	1.72	0	1.72	35.91	5.07	0.02	3	0.96	0.63	2.71	36.55	0.59	18.24	3
28	66.42	2.61	13.43	-4.5	66.58	3.92	4	2.47	127.53	1.79	0	1.79	36.28	4.03	0.01	4	0.94	0.61	2.63	37.49	0.54	21.48	3
29	59.52	3.45	12.94	-4.73	59.68	5.77	4	2.62	129.3	1.85	0	1.85	31.25	5.96	0.02	3	1	0.57	2.81	31.25	0.5	16.1	3
30	72.89	3.03	12.17	-5.19	73.04	4.15	4	2.46	128.84	1.91	0	1.91	37.14	4.26	0.01	4	0.95	0.57	2.64	38.32	0.46	20.72	3
31	64.95	3.65	12.52	-5.67	65.11	5.61	4	2.59	129.94	1.98	0	1.98	31.88	5.79	0.01	3	1	0.53	2.79	31.88	0.46	16.45	3
32	115.6	4.59	12.81	-6.23	115.76	3.97	9	2.31	133.02	2.05	0	2.05	55.57	4.04	0.01	4	0.9	0.55	2.49	59.48	0.45	22.39	5
33	109.34	5.01	15.28	-6.67	109.52	4.58	9	2.38	133.52	2.11	0	2.11	50.83	4.67	0.01	4	0.93	0.53	2.57	53.37	0.52	19.86	3
34	171.47	5.53	14.62	-7.69	171.65	3.22	8	2.14	135.34	2.18	0	2.18	77.71	3.27	0.01	5	0.83	0.55	2.31	87.66	0.48	27.41	5
35	121.55	6.16	16.94	-7.89	121.76	5.06	9	2.38	135.29	2.25	0	2.25	53.15	5.16	0.01	4	0.94	0.49	2.59	55.46	0.54	18.39	3
36	108.81	5.43	15.75	-7.93	109.01	4.98	9	2.41	134.09	2.32	0	2.32	46.08	5.09	0.01	4	0.96	0.47	2.63	47.44	0.49	18.44	3
37	107.46	4.49	13.98	-7.73	107.63	4.17	9	2.35	132.67	2.38	0	2.38	44.19	4.27	0.01	4	0.95	0.46	2.59	46.08	0.42	21.04	3
38	147.35	4.8	13.95	-7.71	147.52	3.26	5	2.18	133.93	2.45	0	2.45	59.24	3.31	0.01	5	0.88	0.48	2.4	65.5	0.41	26.32	5
39	110.07	5.33	15.84	-7.95	110.26	4.83	9	2.39	133.98	2.52	0	2.52	42.83	4.94	0.01	4	0.98	0.43	2.65	43.65	0.45	18.77	3
40	123.02	7.73	18.19	-8.38	123.24	6.27	9	2.46	136.97	2.58	0	2.58	46.69	6.4	0.01	3	1	0.41	2.71	46.69	0.51	15.36	3
41	216.48	7.31	20.37	-9.13	216.73	3.37	8	2.1	137.28	2.65	0	2.65	80.69	3.41	0.01	5	0.86	0.46	2.31	92.11	0.55	26.55	5
42	189.64	0	27.68	-3.22	189.98	0	0	0	87.36	2.7	0	2.7	69.45	0	0.01	0	1	0.39	4.06	69.45	0.74	113.5	0

Depth (ft)	CPT-6 In situ data				Basic output data																		
	qc (tsf)	fs (tsf)	u (psi)	Other	qt (tsf)	Rf(%)	SBT	Ic.SBT	\bar{a} (pcf)	\acute{o},v (tsf)	u0 (tsf)	$\acute{o}',v\acute{o}$ (tsf)	Qt1	Fr (%)	Bq	SBTn	n	Cn	Ic	Qtn	U2	(B)	Mod. SBTn
1	92.73	1.98	1.91	-0.03	92.75	2.14	5	2.18	126.33	0.06	0	0.06	1466.5	2.14	0	8	0.53	4.49	1.78	392.92	2.18	44.23	7
2	49.71	2.09	1.73	-0.2	49.73	4.2	4	2.57	125.19	0.13	0	0.13	394.16	4.21	0	8	0.69	4.32	2.18	202.51	0.99	23.03	5
3	40.52	1.57	1.57	-0.22	40.54	3.86	4	2.61	122.58	0.19	0	0.19	215.8	3.88	0	8	0.72	3.47	2.26	132.15	0.6	24.38	5
4	93.36	2.61	1.92	-1.3	93.38	2.8	5	2.26	128.36	0.25	0	0.25	370.75	2.8	0	8	0.63	2.47	2.02	217.46	0.55	33.47	7
5	203.74	4.7	3.77	-2.68	203.78	2.31	5	1.98	134.56	0.32	0	0.32	638.78	2.31	0	8	0.56	1.95	1.82	375.62	0.85	41.13	7
6	214.81	6.68	4.04	-3.16	214.86	3.11	8	2.07	137.27	0.39	0	0.39	553.9	3.12	0	8	0.61	1.84	1.94	372.51	0.75	31.08	5
7	153.82	6.06	4.13	-3.29	153.87	3.94	8	2.24	135.73	0.46	0	0.46	337.1	3.95	0	8	0.67	1.76	2.1	255.83	0.65	24.61	5
8	129.49	5.53	4.38	-2.87	129.54	4.27	9	2.31	134.65	0.52	0	0.52	247.04	4.29	0	8	0.71	1.65	2.19	201.11	0.6	22.63	5
9	125.52	6.58	4.33	-2.37	125.57	5.24	9	2.39	135.84	0.59	0	0.59	211.76	5.26	0	9	0.75	1.55	2.29	182.89	0.53	18.68	3
10	147.35	6.27	4.26	-2.28	147.4	4.25	9	2.27	135.88	0.66	0	0.66	222.94	4.27	0	8	0.72	1.41	2.19	194.94	0.47	22.71	5
11	186.72	5.12	5	-2.27	186.78	2.74	5	2.06	134.97	0.73	0	0.73	256.36	2.75	0	8	0.65	1.28	2	224.4	0.5	34.11	7
12	131.16	4.8	4.23	-2.11	131.21	3.66	8	2.25	133.65	0.79	0	0.79	164.54	3.68	0	8	0.73	1.23	2.2	152.05	0.38	25.72	5
13	122.49	5.01	4.51	-1.66	122.55	4.09	9	2.31	133.79	0.86	0	0.86	141.61	4.12	0	8	0.76	1.17	2.27	134.61	0.38	23.16	5
14	109.44	5.85	4.6	-1.1	109.5	5.34	9	2.43	134.65	0.93	0	0.93	117.16	5.39	0	9	0.81	1.11	2.41	114.26	0.36	18.13	3
15	178.36	6.68	4.33	-1.06	178.41	3.75	8	2.18	136.81	1	0	1	178.28	3.77	0	8	0.73	1.05	2.17	175.31	0.31	25.37	5
16	159.98	5.22	5	-1.09	160.04	3.26	8	2.16	134.74	1.06	0	1.06	149.62	3.28	0	8	0.73	1	2.17	149.79	0.34	28.43	5
17	128.86	5.12	4.71	-1.21	128.92	3.97	8	2.29	134.07	1.13	0	1.13	113.13	4	0	9	0.78	0.95	2.3	114.75	0.3	23.56	5
18	99.62	8.04	5.09	-1.1	99.69	8.07	9	2.6	136.75	1.2	0	1.2	82.22	8.16	0	9	0.91	0.89	2.64	83.13	0.31	12.44	3
19	297.93	12.22	15.67	-1.74	298.12	4.1	8	2.1	137.28	1.27	0	1.27	234.39	4.12	0	8	0.72	0.88	2.13	246.46	0.89	23.65	5
20	211.05	6.47	16.84	-2.4	211.25	3.06	8	2.07	136.99	1.34	0	1.34	157.23	3.08	0.01	8	0.72	0.85	2.11	167.85	0.91	30.26	5
21	123.33	7.52	16.46	-2.87	123.53	6.09	9	2.45	136.78	1.4	0	1.4	87.02	6.16	0.01	9	0.88	0.78	2.52	90.14	0.84	16.02	3
22	135.65	8.46	16.84	-3.08	135.86	6.23	9	2.43	137.28	1.47	0	1.47	91.28	6.29	0.01	9	0.88	0.75	2.51	95.09	0.82	15.72	3
23	171.05	7.62	16.43	-3.62	171.25	4.45	9	2.25	137.28	1.54	0	1.54	110.16	4.49	0.01	9	0.81	0.74	2.34	118.16	0.77	21.33	3
24	187.03	6.58	17.1	-4.21	187.24	3.51	8	2.15	136.82	1.61	0	1.61	115.36	3.54	0.01	8	0.78	0.72	2.24	126.59	0.77	26.34	5
25	169.9	5.53	17.2	-4.8	170.11	3.25	8	2.14	135.32	1.68	0	1.68	100.45	3.29	0.01	5	0.79	0.7	2.25	110.87	0.74	27.83	5
26	129.8	5.64	17.13	-5	130.01	4.34	9	2.31	134.8	1.74	0	1.74	73.54	4.4	0.01	4	0.86	0.65	2.44	78.79	0.71	21.32	3
27	180.76	7.1	17.36	-5.12	180.98	3.92	8	2.2	137.28	1.81	0	1.81	98.82	3.96	0.01	9	0.82	0.64	2.31	109	0.69	23.7	5
28	156.01	9.92	16.82	-5.29	156.22	6.35	9	2.4	137.28	1.88	0	1.88	82.03	6.43	0.01	9	0.91	0.59	2.54	86.51	0.64	15.42	3
29	145.15	13.47	16.59	-5.2	145.36	9.27	9	2.56	137.28	1.95	0	1.95	73.54	9.39	0.01	9	0.98	0.55	2.71	74.64	0.61	10.98	3
30	168.34	0	17.38	-5.21	168.55	0	0	0	87.36	1.99	0	1.99	83.54	0	0.01	0	1	0.53	4.06	83.54	0.63	133.62	0

Depth (ft)	CPT-7 In situ data				Basic output data																		
	qc (tsf)	fs (tsf)	u (psi)	Other	qt (tsf)	Rf(%)	SBT	Ic.SBT	\bar{a} (pcf)	\acute{o},v (tsf)	u0 (tsf)	\acute{o}',vo (tsf)	Qt1	Fr (%)	Bq	SBTn	n	Cn	Ic	Qtn	U2	(B)	Mod. SBTn
1	45.53	1.46	-0.17	-0.09	45.53	3.21	4	2.52	122.36	0.06	0	0.06	742.66	3.22	0	8	0.63	5.97	2.03	256.34	-0.2	29.78	5
2	32.89	1.46	-1.99	-0.17	32.87	4.45	4	2.72	121.57	0.12	0	0.12	268.33	4.46	0	9	0.72	4.78	2.28	147.83	-1.17	21.62	3
3	36.24	1.04	0.2	-0.26	36.24	2.88	4	2.56	119.34	0.18	0	0.18	198.59	2.9	0	5	0.69	3.4	2.19	115.85	0.08	31.03	5
4	27.26	0.63	0.13	-0.2	27.26	2.3	4	2.6	114.91	0.24	0	0.24	113.02	2.32	0	5	0.72	2.91	2.25	74.25	0.04	34.79	7
5	27.15	1.36	-2.02	-0.18	27.13	5	3	2.82	120.56	0.3	0	0.3	89.61	5.06	-0.01	4	0.82	2.82	2.51	71.48	-0.48	18.87	3
6	27.67	1.46	0.1	-0.27	27.67	5.28	3	2.83	121.15	0.36	0	0.36	75.88	5.35	0	4	0.84	2.48	2.56	64.05	0.02	17.94	3
7	12.53	1.04	-3.58	-0.22	12.49	8.36	3	3.22	116.75	0.42	0	0.42	28.85	8.65	-0.02	3	0.99	2.51	2.95	28.66	-0.62	12.16	3
8	12.84	0.94	-1.44	-0.17	12.83	7.33	3	3.17	116.04	0.48	0	0.48	25.93	7.61	-0.01	3	0.99	2.21	2.94	25.78	-0.22	13.44	3
9	20.47	1.15	-1.74	-0.18	20.45	5.62	3	2.94	118.65	0.54	0	0.54	37.17	5.77	-0.01	3	0.93	1.88	2.76	35.38	-0.23	16.56	3
10	25.48	1.46	-2.39	-0.18	25.45	5.74	3	2.88	120.94	0.6	0	0.6	41.69	5.88	-0.01	3	0.92	1.69	2.73	39.8	-0.29	16.38	3
11	27.46	1.67	-1.39	-0.1	27.45	6.09	3	2.87	122.11	0.66	0	0.66	40.76	6.24	0	3	0.93	1.56	2.75	39.42	-0.15	15.65	3
12	30.18	1.78	-2.16	-0.1	30.15	5.89	3	2.83	122.78	0.72	0	0.72	40.96	6.03	-0.01	3	0.93	1.43	2.74	39.82	-0.22	16.06	3
13	31.12	1.57	-6.24	-0.08	31.04	5.05	3	2.78	121.93	0.78	0	0.78	38.83	5.18	-0.01	3	0.92	1.32	2.71	37.86	-0.58	18	3
14	26	0.84	0.03	0.06	26	3.21	4	2.7	116.9	0.84	0	0.84	30.03	3.32	0	4	0.9	1.23	2.65	29.34	0	23.5	5
15	33.73	0.94	0.48	0.05	33.74	2.79	4	2.58	118.4	0.9	0	0.9	36.6	2.86	0	4	0.86	1.15	2.55	35.78	0.04	26.55	5
16	57.02	1.36	0.53	0.09	57.02	2.38	5	2.36	122.37	0.96	0	0.96	58.5	2.42	0	5	0.79	1.08	2.35	57.29	0.04	32.24	7
17	154.55	1.46	0.4	1.01	154.56	0.95	6	1.77	125.34	1.02	0	1.02	150.36	0.95	0	6	0.57	1.02	1.77	148.09	0.03	74.92	7
18	73.2	1.04	0.75	1.2	73.21	1.43	5	2.13	121.06	1.08	0	1.08	66.69	1.45	0	5	0.72	0.98	2.15	67.11	0.05	46.13	7
19	71.01	1.67	0.68	1.37	71.02	2.35	5	2.29	124.42	1.14	0	1.14	61.09	2.39	0	5	0.79	0.94	2.32	62.11	0.04	33	7
20	15.04	0.63	0.85	1.49	15.05	4.16	3	2.96	113.46	1.2	0	1.2	11.53	4.52	0	3	1	0.88	3.05	11.53	0.05	17.62	2
21	9.61	0.31	0.72	1.44	9.62	3.26	3	3.05	107.3	1.25	0	1.25	6.67	3.75	0.01	3	1	0.84	3.2	6.67	0.04	17.55	2
22	9.19	0.42	-1.56	1.5	9.17	4.55	3	3.15	109.29	1.31	0	1.31	6.01	5.31	-0.01	3	1	0.81	3.32	6.01	-0.09	15.71	2
23	13.05	0.63	0.87	1.5	13.06	4.8	3	3.04	113.12	1.37	0	1.37	8.57	5.36	0.01	3	1	0.78	3.2	8.57	0.05	16.02	2
24	11.9	0.42	0.68	1.46	11.91	3.51	3	2.99	109.93	1.42	0	1.42	7.39	3.98	0	3	1	0.74	3.17	7.39	0.03	17.49	2
25	9.82	0.31	0.48	1.42	9.82	3.19	3	3.04	107.35	1.47	0	1.47	5.66	3.75	0	3	1	0.72	3.26	5.66	0.02	17.16	2
26	9.61	0.42	0.68	1.44	9.62	4.34	3	3.12	109.4	1.53	0	1.53	5.29	5.17	0.01	3	1	0.69	3.36	5.29	0.03	15.71	2
27	10.34	0.63	0.94	1.42	10.35	6.05	3	3.19	112.55	1.59	0	1.59	5.53	7.15	0.01	3	1	0.67	3.43	5.53	0.04	14.18	2
28	113.3	0.84	-2.9	1.43	113.27	0.74	6	1.81	120.49	1.65	0	1.65	67.85	0.75	0	6	0.66	0.75	1.92	78.91	-0.13	68.89	7
29	19.53	0.52	-9.14	1.4	19.42	2.69	4	2.75	112.75	1.7	0	1.7	10.41	2.95	-0.04	3	1	0.62	2.98	10.41	-0.39	20.27	2
30	10.65	0.42	-9.03	1.42	10.54	3.96	3	3.07	109.63	1.76	0	1.76	5	4.76	-0.07	3	1	0.6	3.36	5	-0.37	16	2
31	6.58	0.52	-8.42	1.54	6.48	8.06	3	3.42	110.07	1.81	0	1.81	2.57	11.19	-0.13	2	1	0.58	3.81	2.57	-0.33	12.72	1
32	55.24	1.25	-9.24	1.63	55.13	2.27	5	2.36	121.7	1.87	0	1.87	28.44	2.35	-0.01	4	0.91	0.59	2.55	29.93	-0.36	28.43	5
33	338.87	2.4	-9.07	1.79	338.76	0.71	6	1.44	130.89	1.94	0	1.94	173.83	0.71	0	6	0.53	0.73	1.54	231.15	-0.34	102.69	7
34	323.62	5.01	-10.34	1.93	323.49	1.55	6	1.72	136.16	2.01	0	2.01	160.28	1.56	0	6	0.64	0.66	1.83	201.41	-0.37	55.05	7
35	267.02	8.35	-9.73	2.03	266.9	3.13	8	2.02	137.28	2.07	0	2.07	127.66	3.15	0	5	0.77	0.6	2.15	149.21	-0.34	29.45	5
36	383.46	8.77	-9.71	2.26	383.34	2.29	8	1.82	137.28	2.14	0	2.14	177.87	2.3	0	6	0.69	0.61	1.94	221.21	-0.33	39.93	7
37	334.9	8.56	-9.45	2.33	334.78	2.56	8	1.89	137.28	2.21	0	2.21	150.36	2.57	0	5	0.73	0.58	2.03	183.85	-0.31	35.68	7
38	465.01	5.64	-7.12	2.17	464.93	1.21	6	1.54	137.28	2.28	0	2.28	202.89	1.22	0	6	0.59	0.64	1.66	277.79	-0.22	70.43	7
39	511.07	9.19	-5.99	2.01	510.99	1.8	6	1.67	137.28	2.35	0	2.35	216.54	1.81	0	6	0.64	0.6	1.79	287.86	-0.18	50.48	7
40	123.12	0	16.36	-7.52	123.32	0	0	0	87.36	2.39	0	2.39	50.54	0	0.01	0	1	0.44	4.06	50.54	0.49	86.49	0

Depth (ft)	CPT-8 In situ data				Basic output data																		
	qc (tsf)	fs (tsf)	u (psi)	Other	qt (tsf)	Rf(%)	SBT	Ic.SBT	\bar{a} (pcf)	\acute{o},v (tsf)	u0 (tsf)	$\acute{o}',v\acute{o}$ (tsf)	Qt1	Fr (%)	Bq	SBTn	n	Cn	Ic	Qtn	U2	(B)	Mod. SBTn
1	44.69	1.88	-0.12	1.54	44.69	4.21	4	2.61	124.16	0.06	0	0.06	718.48	4.21	0	8	0.66	6.48	2.11	273.52	-0.13	23.2	5
2	38.01	1.88	-0.31	1.44	38.01	4.95	4	2.71	123.76	0.12	0	0.12	305.41	4.96	0	9	0.73	4.74	2.28	169.67	-0.18	19.7	3
3	18.8	1.36	-3.39	1.44	18.76	7.24	3	3.04	119.66	0.18	0	0.18	101.09	7.31	-0.01	9	0.85	4.46	2.61	78.21	-1.33	13.75	3
4	30.08	1.15	-3.48	1.37	30.03	3.82	4	2.71	119.58	0.24	0	0.24	122.31	3.86	-0.01	4	0.76	3.07	2.37	86.38	-1.03	23.91	5
5	28.09	1.67	-3.96	1.28	28.04	5.96	3	2.86	122.16	0.3	0	0.3	91.04	6.02	-0.01	9	0.84	2.84	2.56	74.53	-0.94	16.29	3
6	25.17	1.46	-3.76	1.28	25.12	5.82	3	2.89	120.91	0.37	0	0.37	67.79	5.91	-0.01	4	0.86	2.51	2.62	58.72	-0.74	16.49	3
7	28.51	1.46	-4.06	1.44	28.46	5.14	3	2.81	121.22	0.43	0	0.43	65.84	5.22	-0.01	4	0.85	2.18	2.58	57.66	-0.69	18.25	3
8	30.18	1.57	-3.79	1.48	30.13	5.2	3	2.79	121.86	0.49	0	0.49	60.93	5.28	-0.01	4	0.86	1.96	2.6	54.83	-0.56	18.02	3
9	33.63	1.57	-3.57	1.52	33.58	4.66	4	2.73	122.13	0.55	0	0.55	60.32	4.74	-0.01	4	0.85	1.75	2.57	54.79	-0.47	19.65	3
10	33.94	1.67	-3.67	1.5	33.89	4.93	3	2.74	122.62	0.61	0	0.61	54.65	5.02	-0.01	4	0.87	1.62	2.61	50.94	-0.43	18.71	3
11	35.92	1.67	-3.58	1.51	35.88	4.66	4	2.71	122.76	0.67	0	0.67	52.51	4.75	-0.01	4	0.87	1.49	2.6	49.53	-0.38	19.52	3
12	21.09	1.57	-4.36	1.52	21.04	7.44	3	3.02	120.99	0.73	0	0.73	27.78	7.71	-0.02	3	1	1.45	2.92	27.77	-0.43	13.29	3
13	37.91	1.67	-0.96	1.6	37.9	4.41	4	2.67	122.89	0.79	0	0.79	46.83	4.5	0	4	0.88	1.29	2.61	45.25	-0.09	20.18	3
14	38.43	1.67	-1.06	1.67	38.42	4.35	4	2.66	122.93	0.85	0	0.85	44	4.45	0	4	0.89	1.21	2.62	42.96	-0.09	20.28	3
15	37.49	1.67	-0.63	1.66	37.48	4.46	4	2.68	122.87	0.92	0	0.92	39.95	4.57	0	4	0.9	1.14	2.65	39.4	-0.05	19.76	3
16	30.28	1.46	-1.26	1.62	30.27	4.83	3	2.77	121.37	0.98	0	0.98	30.01	4.99	0	3	0.95	1.08	2.77	29.89	-0.09	18.2	3
17	28.93	1.36	-1.35	1.64	28.91	4.7	3	2.78	120.71	1.04	0	1.04	26.9	4.87	0	3	0.96	1.02	2.79	26.87	-0.09	18.36	3
18	24.44	1.15	-1.55	1.6	24.42	4.7	3	2.83	119.08	1.1	0	1.1	21.28	4.93	0	3	1	0.97	2.87	21.29	-0.1	17.89	3
19	23.29	1.15	-1.64	1.42	23.27	4.94	3	2.86	118.96	1.16	0	1.16	19.14	5.19	-0.01	3	1	0.92	2.92	19.14	-0.1	17.2	3
20	19.01	1.36	0.16	1.38	19.01	7.14	3	3.03	119.69	1.22	0	1.22	14.64	7.63	0	3	1	0.87	3.12	14.64	0.01	13.56	3
21	28.93	1.36	-0.61	1.38	28.92	4.69	3	2.78	120.71	1.28	0	1.28	21.67	4.91	0	3	1	0.83	2.86	21.67	-0.03	17.95	3
22	30.6	1.67	-0.58	1.34	30.59	5.46	3	2.8	122.37	1.34	0	1.34	21.88	5.71	0	3	1	0.79	2.91	21.88	-0.03	16.35	3
23	27.99	1.46	-0.87	1.4	27.98	5.23	3	2.82	121.18	1.4	0	1.4	19.02	5.5	0	3	1	0.76	2.94	19.02	-0.04	16.62	3
24	28.82	1.67	-2.51	1.44	28.79	5.8	3	2.84	122.22	1.46	0	1.46	18.74	6.11	-0.01	3	1	0.73	2.98	18.74	-0.12	15.57	3
25	24.33	1.46	-5.01	1.4	24.27	6.02	3	2.91	120.83	1.52	0	1.52	14.98	6.43	-0.02	3	1	0.7	3.06	14.98	-0.24	15.02	3
26	17.96	1.04	-4.64	1.28	17.9	5.83	3	2.99	117.62	1.58	0	1.58	10.35	6.4	-0.02	3	1	0.67	3.18	10.35	-0.21	14.94	2
27	22.24	1.46	-7.9	1.26	22.15	6.6	3	2.96	120.61	1.64	0	1.64	12.52	7.13	-0.03	3	1	0.65	3.15	12.52	-0.35	14.14	3
28	18.69	1.25	-6.42	1.33	18.61	6.73	3	3.02	119.05	1.7	0	1.7	9.97	7.41	-0.03	3	1	0.62	3.24	9.97	-0.27	13.88	2
29	18.59	1.04	-6.22	1.38	18.51	5.64	3	2.97	117.71	1.76	0	1.76	9.54	6.23	-0.03	3	1	0.6	3.2	9.54	-0.26	15.09	2
30	19.84	0	-6.67	1.26	19.76	0	0	0	87.36	1.8	0	1.8	9.98	0	-0.03	0	1	0.59	4.06	9.98	-0.27	28.54	0

Depth (ft)	CPT-9 In situ data				Basic output data																		
	qc (tsf)	fs (tsf)	u (psi)	Other	qt (tsf)	Rf(%)	SBT	Ic SBT	\bar{a} (pcf)	\dot{o},v (tsf)	u0 (tsf)	\dot{o}',vo (tsf)	Qt1	Fr (%)	Bq	SBTn	n	Cn	Ic	Qtn	U2	(B)	Mod. SBTn
1	57.54	1.88	0.19	-0.69	57.54	3.27	4	2.45	124.77	0.06	0	0.06	920.74	3.27	0	8	0.61	5.67	1.99	308.21	0.22	29.52	5
2	48.98	1.78	0.39	-0.73	48.98	3.62	4	2.53	123.96	0.12	0	0.12	392.58	3.63	0	8	0.67	4.2	2.14	193.99	0.23	26.33	5
3	48.77	1.57	-5.01	-0.66	48.71	3.22	4	2.5	123.03	0.19	0	0.19	261.14	3.23	-0.01	8	0.68	3.27	2.16	150.13	-1.94	28.87	5
4	32.79	1.88	-4.19	-0.8	32.74	5.74	3	2.8	123.4	0.25	0	0.25	131.25	5.79	-0.01	9	0.8	3.21	2.47	98.55	-1.22	16.96	3
5	26.94	1.36	-4.46	-0.89	26.89	5.05	3	2.82	120.54	0.31	0	0.31	86.34	5.11	-0.01	4	0.83	2.77	2.52	69.6	-1.04	18.71	3
6	20.15	1.15	-0.65	-0.89	20.15	5.7	3	2.95	118.61	0.37	0	0.37	53.87	5.81	0	3	0.89	2.55	2.67	47.72	-0.13	16.63	3
7	27.78	1.15	-0.87	-0.95	27.77	4.14	4	2.75	119.39	0.43	0	0.43	64.04	4.2	0	4	0.83	2.13	2.53	55.03	-0.15	21.59	3
8	42.5	1.57	-1.07	-0.97	42.49	3.69	4	2.58	122.7	0.49	0	0.49	86.05	3.73	0	4	0.79	1.84	2.41	73.12	-0.16	24.25	5
9	21.83	1.36	-0.48	-0.82	21.82	6.22	3	2.95	120.03	0.55	0	0.55	38.8	6.38	0	3	0.93	1.85	2.78	37.16	-0.06	15.35	3
10	28.72	1.57	-0.33	-0.82	28.71	5.46	3	2.82	121.74	0.61	0	0.61	46.14	5.57	0	3	0.9	1.65	2.69	43.72	-0.04	17.13	3
11	36.03	1.78	-0.36	-0.88	36.02	4.93	3	2.72	123.21	0.67	0	0.67	52.71	5.02	0	4	0.88	1.49	2.61	49.85	-0.04	18.68	3
12	38.12	1.88	-0.55	-0.93	38.11	4.93	4	2.71	123.77	0.73	0	0.73	51.02	5.03	0	4	0.88	1.38	2.62	48.87	-0.05	18.64	3
13	34.36	1.88	-0.39	-0.97	34.35	5.47	3	2.77	123.52	0.79	0	0.79	42.25	5.6	0	3	0.92	1.3	2.7	41.27	-0.04	17.02	3
14	34.67	1.78	-1.3	-0.95	34.65	5.12	3	2.75	123.12	0.86	0	0.86	39.49	5.25	0	3	0.92	1.22	2.7	38.83	-0.11	17.82	3
15	33.83	1.88	-0.89	-0.93	33.82	5.56	3	2.78	123.48	0.92	0	0.92	35.86	5.71	0	3	0.94	1.14	2.75	35.57	-0.07	16.68	3
16	179.41	2.09	-0.48	-0.89	179.4	1.16	6	1.79	128.32	0.98	0	0.98	181.72	1.17	0	6	0.57	1.04	1.78	176.01	-0.04	67.39	7
17	27.15	1.88	-0.46	-0.73	27.15	6.92	3	2.91	122.94	1.04	0	1.04	25.02	7.2	0	3	1	1.01	2.93	25.02	-0.03	14	3
18	26.21	0.94	0.48	-0.63	26.22	3.58	4	2.73	117.78	1.1	0	1.1	22.79	3.74	0	4	0.96	0.96	2.77	22.83	0.03	21.12	3
19	12.64	0.73	0.1	-0.62	12.64	5.78	3	3.11	114.17	1.16	0	1.16	9.9	6.37	0	3	1	0.91	3.2	9.9	0.01	14.96	2
20	16.19	0.73	-0.29	-0.62	16.18	4.52	3	2.96	114.77	1.22	0	1.22	12.3	4.88	0	3	1	0.87	3.05	12.3	-0.02	17.14	3
21	17.23	0.94	-0.4	-0.75	17.23	5.46	3	2.99	116.76	1.28	0	1.28	12.51	5.89	0	3	1	0.83	3.1	12.51	-0.02	15.66	3
22	19.11	1.36	-0.89	-0.62	19.1	7.11	3	3.03	119.7	1.33	0	1.33	13.31	7.64	0	3	1	0.79	3.15	13.31	-0.05	13.57	3
23	42.08	1.88	-1.28	-0.53	42.07	4.47	4	2.65	124.01	1.4	0	1.4	29.12	4.62	0	3	0.96	0.77	2.75	29.42	-0.07	19.14	3
24	74.35	2.82	-1.15	-0.54	74.34	3.79	4	2.42	128.36	1.46	0	1.46	49.88	3.87	0	4	0.88	0.75	2.52	51.87	-0.06	22.86	5
25	71.95	3.65	-6.57	-0.51	71.87	5.09	4	2.53	130.18	1.53	0	1.53	46.09	5.2	-0.01	4	0.93	0.71	2.64	47.32	-0.31	18.15	3
26	91.37	3.65	-6.18	-0.37	91.3	4	4	2.38	130.76	1.59	0	1.59	56.36	4.07	0	4	0.88	0.7	2.5	59.28	-0.28	22.24	5
27	95.55	3.97	-5.88	-0.28	95.48	4.16	4	2.38	131.48	1.66	0	1.66	56.61	4.23	0	4	0.88	0.67	2.51	59.65	-0.26	21.61	3
28	66.73	3.34	-6.57	-0.29	66.65	5.01	4	2.55	129.34	1.72	0	1.72	37.71	5.15	-0.01	3	0.96	0.63	2.7	38.45	-0.27	18.09	3
29	85.84	3.34	-6.57	-0.25	85.76	3.9	4	2.39	129.96	1.79	0	1.79	46.99	3.98	-0.01	4	0.9	0.62	2.54	49.43	-0.26	22.28	5
30	83.33	4.18	-6.46	-0.05	83.25	5.02	9	2.48	131.52	1.85	0	1.85	43.94	5.13	-0.01	4	0.95	0.59	2.65	45.26	-0.25	18.28	3
31	93.57	4.18	-6.38	-0.2	93.49	4.47	9	2.41	131.8	1.92	0	1.92	47.73	4.56	-0.01	4	0.93	0.58	2.58	49.91	-0.24	20.13	3
32	66	3.97	-6.13	-0.16	65.92	6.02	4	2.61	130.57	1.98	0	1.98	32.23	6.21	-0.01	3	1	0.53	2.81	32.23	-0.22	15.64	3
33	77.59	3.55	-6.49	0.04	77.51	4.58	4	2.47	130.15	2.05	0	2.05	36.83	4.71	-0.01	4	0.97	0.53	2.68	37.64	-0.23	19.28	3
34	60.99	2.72	-6.43	0.04	60.91	4.46	4	2.53	127.6	2.11	0	2.11	27.83	4.62	-0.01	3	1	0.5	2.77	27.83	-0.22	19.06	3
35	50.44	2.51	-8.02	-0.11	50.34	4.98	4	2.62	126.55	2.18	0	2.18	22.13	5.2	-0.01	3	1	0.49	2.87	22.13	-0.27	17.35	3
36	103.7	3.55	-11.01	-0.9	103.56	3.43	5	2.3	130.86	2.24	0	2.24	45.2	3.5	-0.01	4	0.91	0.5	2.51	48.24	-0.35	24.36	5
37	91.48	3.65	-11.11	-1.13	91.34	4	4	2.38	130.77	2.31	0	2.31	38.6	4.11	-0.01	4	0.96	0.47	2.62	39.92	-0.35	21.34	3
38	68.5	3.55	-10.82	-1.01	68.37	5.19	4	2.55	129.85	2.37	0	2.37	27.83	5.38	-0.01	3	1	0.45	2.81	27.83	-0.33	17.22	3
39	85.32	3.34	-10.72	-0.81	85.19	3.92	4	2.39	129.94	2.44	0	2.44	33.96	4.04	-0.01	4	0.98	0.44	2.66	34.59	-0.32	21.27	3
40	89.18	3.55	-10.65	-0.65	89.05	3.99	4	2.39	130.49	2.5	0	2.5	34.59	4.1	-0.01	4	0.98	0.43	2.66	35.17	-0.31	21.08	3
41	105.89	3.86	-10.53	-0.57	105.76	3.65	5	2.31	131.53	2.57	0	2.57	40.19	3.74	-0.01	4	0.95	0.43	2.57	41.9	-0.3	22.88	5
42	132.83	4.49	-10.72	-0.43	132.7	3.38	5	2.22	133.18	2.63	0	2.63	49.37	3.45	-0.01	4	0.92	0.43	2.48	53.16	-0.29	24.91	5
43	205.41	4.8	-10.53	-0.19	205.28	2.34	5	1.98	134.74	2.7	0	2.7	74.98	2.37	0	5	0.82	0.46	2.2	88.97	-0.28	35.22	7
44	145.68	4.59	-10.47	-0.11	145.55	3.16	5	2.17	133.58	2.77	0	2.77	51.57	3.22	-0.01	4	0.91	0.42	2.44	56.2	-0.27	26.39	5
45	82.39	5.01	-10.44	0.12	82.27	6.09	9	2.55	132.82	2.83	0	2.83	28.02	6.31	-0.01	3	1	0.37	2.86	28.02	-0.27	15.4	3
46	123.54	6.27	-10.53	0.32	123.41	5.08	9	2.38	135.44	2.9	0	2.9	41.52	5.2	-0.01	4	1	0.36	2.68	41.52	-0.26	18.02	3
47	134.82	6.47	-10.52	0.67	134.69	4.81	9	2.34	135.9	2.97	0	2.97	44.34	4.92	-0.01	4	1	0.36	2.64	44.48	-0.26	18.87	3
48	110.07	4.07	-10.54	0.71	109.94	3.7	5	2.3	132.01	3.04	0	3.04	35.21	3.81	-0.01	4	1	0.35	2.63	35.3	-0.25	22.15	5
49	107.56	4.8	-10.39	0.87	107.43	4.47	9	2.37	133.16	3.1	0	3.1	33.62	4.6	-0.01	4	1	0.34	2.71	33.62	-0.24	19.4	3
50	114.77	0	-10.53	0.97	114.64	0	0	0	87.36	3.15	0	3.15	35.43	0	-0.01	0	1	0.34	4.06	35.43	-0.24	64.9	0

Depth (ft)	CPT-10 In situ data				Basic output data																		
	qc (tsf)	fs (tsf)	u (psi)	Other	qt (tsf)	Rf(%)	SBT	Ic.SBT	\bar{a} (pcf)	ϕ_v (tsf)	u0 (tsf)	ϕ',v_0 (tsf)	Qt1	Fr (%)	Bq	SBTn	n	Cn	Ic	Qtn	U2	(B)	Mod. SBTn
1	71.01	3.03	0.87	0.32	71.02	4.26	4	2.47	128.78	0.06	0	0.06	1101.3	4.27	0	8	0.63	5.88	2.05	394.52	0.97	23.07	5
2	40	2.19	0.77	0.12	40.01	5.48	3	2.72	125.01	0.13	0	0.13	314.05	5.5	0	9	0.74	4.75	2.31	179.2	0.44	17.93	3
3	52.53	1.67	1.05	0.34	52.54	3.18	4	2.47	123.69	0.19	0	0.19	277.49	3.19	0	8	0.68	3.2	2.14	158.46	0.4	29.26	5
4	28.82	1.25	1	0.53	28.83	4.35	3	2.76	120.12	0.25	0	0.25	114.91	4.38	0	4	0.78	3.11	2.42	83.92	0.29	21.45	3
5	22.66	1.36	1.06	0.67	22.67	5.99	3	2.93	120.12	0.31	0	0.31	72.41	6.07	0	4	0.86	2.89	2.62	61.05	0.25	16.13	3
6	21.2	1.36	0.29	0.79	21.2	6.4	3	2.97	119.96	0.37	0	0.37	56.48	6.52	0	3	0.89	2.56	2.69	50.49	0.06	15.16	3
7	30.08	1.57	0.1	0.9	30.08	5.21	3	2.8	121.86	0.43	0	0.43	68.97	5.28	0	4	0.85	2.15	2.57	60.32	0.02	18.09	3
8	38.32	1.98	0.48	0.97	38.33	5.18	3	2.72	124.18	0.49	0	0.49	76.94	5.24	0	4	0.84	1.9	2.54	68.07	0.07	18.29	3
9	41.67	2.4	0.39	0.97	41.67	5.76	3	2.73	125.78	0.55	0	0.55	74.12	5.84	0	9	0.86	1.74	2.58	67.61	0.05	16.69	3
10	70.8	2.82	0.79	1.18	70.81	3.98	4	2.45	128.25	0.62	0	0.62	113.42	4.02	0	9	0.77	1.51	2.34	100.33	0.09	23.33	5
11	57.43	2.51	0.87	1.4	57.45	4.36	4	2.54	126.87	0.68	0	0.68	83.19	4.42	0	4	0.82	1.43	2.45	76.71	0.09	21.22	3
12	61.09	2.09	0.36	1.36	61.09	3.42	4	2.45	125.69	0.75	0	0.75	80.98	3.46	0	5	0.79	1.32	2.37	75.23	0.04	25.8	5
13	56.7	1.98	0.39	1.54	56.71	3.5	4	2.48	125.13	0.81	0	0.81	69.22	3.55	0	4	0.81	1.24	2.42	65.77	0.04	24.97	5
14	59.94	2.09	0.69	1.93	59.95	3.48	4	2.46	125.64	0.87	0	0.87	67.87	3.54	0	4	0.81	1.17	2.42	65.45	0.06	25.03	5
15	57.75	2.4	0.47	2.37	57.75	4.16	4	2.53	126.58	0.93	0	0.93	60.85	4.23	0	4	0.85	1.11	2.51	59.71	0.04	21.62	3
16	67.77	2.51	0.58	2.91	67.78	3.7	4	2.44	127.28	1	0	1	66.95	3.75	0	4	0.83	1.05	2.44	66.26	0.04	23.93	5
17	54.82	2.19	0.39	3.21	54.83	4	4	2.53	125.78	1.06	0	1.06	50.7	4.08	0	4	0.87	1	2.54	50.72	0.03	21.93	3
18	44.9	1.88	0.77	3.51	44.91	4.19	4	2.6	124.17	1.12	0	1.12	39.02	4.29	0	4	0.91	0.95	2.64	39.23	0.05	20.65	3
19	45.01	1.78	0.77	3.97	45.02	3.94	4	2.59	123.76	1.18	0	1.18	37.01	4.05	0	4	0.91	0.9	2.63	37.39	0.05	21.4	3
20	34.77	1.46	0.48	4.28	34.78	4.2	4	2.69	121.71	1.25	0	1.25	26.93	4.36	0	3	0.96	0.86	2.76	27.11	0.03	19.72	3
21	36.65	1.36	0.68	4.54	36.66	3.7	4	2.63	121.29	1.31	0	1.31	27.08	3.84	0	4	0.95	0.82	2.72	27.38	0.04	21.34	3
22	36.13	1.46	0.58	5.14	36.14	4.05	4	2.66	121.8	1.37	0	1.37	25.44	4.2	0	3	0.97	0.78	2.77	25.65	0.03	20.05	3
23	22.66	1.25	0.19	5.04	22.66	5.53	3	2.9	119.53	1.43	0	1.43	14.89	5.9	0	3	1	0.74	3.04	14.89	0.01	15.77	3
24	23.5	1.15	0.29	5.26	23.5	4.89	3	2.86	118.99	1.49	0	1.49	14.81	5.22	0	3	1	0.71	3.01	14.81	0.01	16.85	3
25	17.23	0.94	-0.14	5.37	17.23	5.46	3	2.99	116.76	1.54	0	1.54	10.16	5.99	0	3	1	0.69	3.17	10.16	-0.01	15.4	2
26	11.9	0	-0.01	5.37	11.9	0	0	0	87.36	1.59	0	1.59	6.5	0	0	0	1	0.67	4.06	6.5	0	23.57	0

Depth (ft)	CPT-11 In situ data				Basic output data																		
	qc (tsf)	fs (tsf)	u (psi)	Other	qt (tsf)	Rf(%)	SBT	Ic SBT	\bar{a} (pcf)	\dot{o},v (tsf)	u0 (tsf)	\dot{o}',vo (tsf)	Qt1	Fr (%)	Bq	SBTn	n	Cn	Ic	Qtn	U2	(B)	Mod. SBTn
1	60.88	1.98	0.48	2.59	60.89	3.26	4	2.43	125.31	0.06	0	0.06	970.17	3.26	0	8	0.61	5.6	1.98	321.74	0.55	29.63	5
2	38.53	1.78	-3.78	2.48	38.49	4.61	4	2.68	123.37	0.12	0	0.12	308.33	4.63	-0.01	9	0.72	4.64	2.26	168.22	-2.19	21.01	3
3	84.27	1.98	-1.73	2.49	84.25	2.35	5	2.24	126.1	0.19	0	0.19	448.81	2.36	0	6	0.6	2.83	1.95	224.79	-0.67	39.1	7
4	32.79	1.98	0.29	2.51	32.79	6.05	3	2.81	123.8	0.25	0	0.25	130.57	6.1	0	9	0.81	3.22	2.49	99.11	0.08	16.18	3
5	25.06	1.46	0.43	2.57	25.07	5.83	3	2.89	120.91	0.31	0	0.31	79.93	5.91	0	9	0.85	2.84	2.58	66.4	0.1	16.53	3
6	20.26	1.15	0.19	2.47	20.26	5.67	3	2.95	118.62	0.37	0	0.37	53.9	5.77	0	3	0.88	2.54	2.67	47.74	0.04	16.7	3
7	24.02	0.84	0.06	2.41	24.02	3.48	4	2.75	116.71	0.43	0	0.43	55.19	3.54	0	4	0.83	2.12	2.52	47.32	0.01	24.13	5
8	8.77	0.63	0.6	2.44	8.78	7.14	3	3.29	112.15	0.48	0	0.48	17.16	7.55	0.01	3	1	2.19	3.07	17.16	0.09	13.61	3
9	27.88	1.67	0.02	2.33	27.88	5.99	3	2.86	122.14	0.54	0	0.54	50.21	6.11	0	3	0.9	1.82	2.69	47.06	0	15.96	3
10	36.86	1.98	0.02	2.35	36.86	5.38	3	2.74	124.08	0.61	0	0.61	59.77	5.47	0	4	0.87	1.63	2.61	55.7	0	17.53	3
11	52.42	2.3	-1.84	2.39	52.4	4.38	4	2.57	126.01	0.67	0	0.67	77.25	4.44	0	4	0.82	1.46	2.47	71.25	-0.2	21.03	3
12	68.61	2.82	-3.48	2.45	68.57	4.11	4	2.47	128.17	0.73	0	0.73	92.44	4.16	0	4	0.8	1.34	2.4	85.85	-0.34	22.46	5
13	48.87	2.82	-4.15	2.53	48.82	5.78	3	2.68	127.34	0.8	0	0.8	60.23	5.87	-0.01	4	0.89	1.28	2.62	58.32	-0.37	16.57	3
14	51.48	2.4	-4.88	2.62	51.42	4.67	4	2.6	126.29	0.86	0	0.86	58.76	4.75	-0.01	4	0.86	1.2	2.56	57.14	-0.41	19.66	3
15	42.5	2.09	-1.7	2.78	42.48	4.92	4	2.67	124.8	0.92	0	0.92	45.03	5.03	0	4	0.9	1.13	2.65	44.43	-0.13	18.56	3
16	29.45	1.25	-2.03	2.94	29.42	4.26	4	2.74	120.17	0.98	0	0.98	28.93	4.41	-0.01	4	0.94	1.07	2.74	28.81	-0.15	19.71	3
17	38.95	1.46	-1.93	3.03	38.93	3.76	4	2.62	121.98	1.04	0	1.04	36.28	3.86	0	4	0.9	1.01	2.63	36.24	-0.13	22.03	5
18	41.56	1.98	-2.77	3.2	41.53	4.78	4	2.67	124.37	1.11	0	1.11	36.55	4.91	0	4	0.93	0.96	2.7	36.66	-0.18	18.67	3
19	44.28	2.51	-4.99	3.46	44.22	5.67	3	2.7	126.24	1.17	0	1.17	36.82	5.82	-0.01	3	0.95	0.91	2.75	36.99	-0.31	16.47	3
20	35.71	2.19	-5.6	3.71	35.65	6.15	3	2.79	124.73	1.23	0	1.23	27.94	6.37	-0.01	3	1	0.86	2.86	27.95	-0.33	15.3	3
21	33.1	1.67	-4.35	3.75	33.05	5.06	3	2.76	122.56	1.29	0	1.29	24.56	5.26	-0.01	3	0.99	0.82	2.84	24.59	-0.24	17.35	3
22	37.7	1.88	-4.43	3.89	37.64	4.99	3	2.71	123.74	1.35	0	1.35	26.78	5.18	-0.01	3	0.99	0.78	2.81	26.88	-0.24	17.63	3
23	38.74	1.78	-4.02	3.84	38.69	4.59	4	2.68	123.39	1.42	0	1.42	26.32	4.76	-0.01	3	0.98	0.75	2.79	26.47	-0.2	18.6	3
24	71.01	1.98	-3.89	4.08	70.96	2.8	5	2.34	125.68	1.48	0	1.48	46.97	2.86	0	5	0.85	0.75	2.44	49.38	-0.19	28.14	5
25	43.55	2.09	-4.55	4.37	43.49	4.8	4	2.66	124.86	1.54	0	1.54	27.21	4.98	-0.01	3	0.99	0.69	2.79	27.34	-0.21	18.12	3
26	35.4	1.46	-4.17	4.76	35.35	4.14	4	2.68	121.75	1.6	0	1.6	21.06	4.33	-0.01	3	1	0.66	2.84	21.06	-0.19	19.26	3
27	58.06	2.51	-5.05	4.64	58	4.32	4	2.54	126.9	1.67	0	1.67	33.81	4.45	-0.01	4	0.95	0.65	2.69	34.54	-0.22	19.91	3
28	43.76	2.61	-7.43	5.15	43.66	5.98	3	2.72	126.5	1.73	0	1.73	24.25	6.23	-0.01	3	1	0.61	2.9	24.25	-0.31	15.5	3
29	44.17	2.09	-6.65	5.17	44.09	4.74	4	2.65	124.89	1.79	0	1.79	23.61	4.94	-0.01	3	1	0.59	2.84	23.61	-0.27	18.01	3
30	87.51	2.3	-6.49	4.74	87.43	2.63	5	2.26	127.26	1.86	0	1.86	46.12	2.68	-0.01	5	0.86	0.62	2.42	49.88	-0.25	29.37	5
31	69.97	3.13	-5.91	5.2	69.89	4.48	4	2.5	128.99	1.92	0	1.92	35.4	4.61	-0.01	4	0.96	0.56	2.68	36.19	-0.22	19.51	3
32	51.38	5.64	-6.05	5.2	51.3	10.99	3	2.88	132.53	1.99	0	1.99	24.83	11.43	-0.01	3	1	0.53	3.08	24.83	-0.22	9.84	2
33	82.08	4.49	-4.76	5.26	82.02	5.47	9	2.52	132.01	2.05	0	2.05	38.97	5.62	0	3	0.98	0.52	2.72	39.41	-0.17	16.96	3
34	53.88	2.51	-2.8	5.46	53.85	4.65	4	2.58	126.72	2.12	0	2.12	24.46	4.84	0	3	1	0.5	2.82	24.46	-0.1	18.28	3
35	38.01	3.03	-2.61	5.64	37.98	7.97	3	2.86	127.25	2.18	0	2.18	16.43	8.46	-0.01	3	1	0.49	3.11	16.43	-0.09	12.65	3
36	38.32	2.09	-2.61	5.8	38.29	5.45	3	2.74	124.55	2.24	0	2.24	16.08	5.79	-0.01	3	1	0.47	3.01	16.08	-0.08	15.98	3
37	35.71	1.46	-2.51	5.85	35.68	4.1	4	2.67	121.77	2.3	0	2.3	14.5	4.38	-0.01	3	1	0.46	2.97	14.5	-0.08	18.35	3
38	42.71	1.15	-2.51	5.96	42.68	2.69	4	2.49	120.44	2.36	0	2.36	17.07	2.85	0	4	1	0.45	2.8	17.07	-0.08	22.82	5
39	43.02	1.36	-2.12	6.12	43	3.16	4	2.53	121.68	2.42	0	2.42	16.74	3.35	0	3	1	0.44	2.84	16.74	-0.06	21.22	3
40	35.3	1.57	-2.8	6.24	35.26	4.44	4	2.7	122.24	2.48	0	2.48	13.19	4.78	-0.01	3	1	0.43	3.02	13.19	-0.08	17.43	3
41	37.18	1.15	-2.51	6.24	37.15	3.09	4	2.57	120.1	2.54	0	2.54	13.6	3.32	-0.01	3	1	0.42	2.91	13.6	-0.07	20.49	2
42	35.09	1.46	-1.45	6.27	35.07	4.17	4	2.68	121.73	2.61	0	2.61	12.46	4.5	0	3	1	0.41	3.02	12.46	-0.04	17.81	3
43	30.91	1.15	-1.64	6.33	30.89	3.72	4	2.69	119.65	2.67	0	2.67	10.59	4.07	0	3	1	0.4	3.05	10.59	-0.04	18.21	2
44	53.78	1.36	-1.75	6.33	53.76	2.53	5	2.4	122.23	2.73	0	2.73	18.72	2.66	0	4	1	0.39	2.75	18.72	-0.05	23.97	5
45	35.92	1.78	-1.25	6.4	35.91	4.94	3	2.72	123.2	2.79	0	2.79	11.88	5.36	0	3	1	0.38	3.09	11.88	-0.03	16.37	3
46	36.97	1.78	-0.77	6.48	36.96	4.8	4	2.71	123.28	2.85	0	2.85	11.97	5.2	0	3	1	0.37	3.08	11.97	-0.02	16.61	3
47	64.12	2.4	-0.88	6.61	64.11	3.75	4	2.46	126.83	2.91	0	2.91	21.01	3.92	0	3	1	0.36	2.81	21.01	-0.02	20.34	3
48	47.72	2.09	-1.06	6.73	47.71	4.38	4	2.6	125.09	2.98	0	2.98	15.03	4.67	0	3	1	0.36	2.97	15.03	-0.03	17.86	3
49	66.73	2.4	-0.1	6.79	66.73	3.6	4	2.44	126.93	3.04	0	3.04	20.96	3.77	0	3	1	0.35	2.8	20.96	0	20.77	3
50	117.59	0	1.06	6.95	117.6	0	0	0	87.36	3.08	0	3.08	37.15	0	0	0	1	0.34	4.06	37.15	0.02	67.35	0

Depth (ft)	CPT-12 In situ data				Basic output data																		
	qc (tsf)	fs (tsf)	u (psi)	Other	qt (tsf)	Rf(%)	SBT	Ic.SBT	\bar{a} (pcf)	\acute{o},v (tsf)	u0 (tsf)	\acute{o}',vo (tsf)	Qt1	Fr (%)	Bq	SBTn	n	Cn	Ic	Qtn	U2	(B)	Mod. SBTn
1	49.5	1.78	1.08	0.05	49.51	3.59	4	2.53	123.99	0.06	0	0.06	797.13	3.59	0	8	0.63	6.04	2.05	282.23	1.25	26.98	5
2	46.78	1.67	0.34	0.32	46.79	3.57	4	2.54	123.41	0.12	0	0.12	376.99	3.58	0	8	0.67	4.23	2.14	186.59	0.2	26.63	5
3	25.48	1.25	-0.57	0.37	25.47	4.92	3	2.83	119.82	0.18	0	0.18	137.8	4.96	0	9	0.78	3.94	2.43	94.23	-0.23	19.41	3
4	27.88	1.04	0.4	0.49	27.89	3.74	4	2.72	118.71	0.24	0	0.24	113.8	3.78	0	4	0.77	3.09	2.38	80.85	0.12	24.2	5
5	28.61	0.84	-0.11	0.63	28.61	2.92	4	2.64	117.14	0.3	0	0.3	93.89	2.95	0	5	0.76	2.59	2.35	69.28	-0.03	28.89	5
6	26.73	1.98	0.02	0.74	26.73	7.42	3	2.94	123.3	0.36	0	0.36	72.6	7.52	0	9	0.89	2.58	2.68	64.29	0	13.42	3
7	147.56	3.55	0.29	1.04	147.56	2.41	5	2.08	131.72	0.43	0	0.43	342.86	2.41	0	6	0.61	1.73	1.94	240.73	0.05	38.52	7
8	32.16	1.36	3.29	1.28	32.2	4.22	4	2.71	120.98	0.49	0	0.49	64.8	4.28	0.01	4	0.83	1.9	2.52	57.02	0.48	21.34	3
9	28.09	1.04	1.83	1.44	28.11	3.71	4	2.72	118.73	0.55	0	0.55	50.22	3.79	0	4	0.85	1.75	2.55	45.47	0.24	22.9	5
10	34.98	1.15	1.97	1.52	35.01	3.28	4	2.61	119.96	0.61	0	0.61	56.5	3.34	0	4	0.82	1.58	2.48	51.22	0.23	25.4	5
11	31.01	1.57	1.3	1.55	31.03	5.05	3	2.78	121.93	0.67	0	0.67	45.32	5.16	0	4	0.9	1.51	2.66	43.24	0.14	18.17	3
12	37.07	1.46	0.4	1.74	37.08	3.94	4	2.65	121.86	0.73	0	0.73	49.73	4.02	0	4	0.86	1.37	2.56	47.22	0.04	22.01	3
13	28.2	1.78	-1.04	1.78	28.18	6.3	3	2.87	122.61	0.79	0	0.79	34.58	6.48	0	3	0.96	1.32	2.81	34.15	-0.09	15.15	3
14	28.09	2.3	-1.05	2.02	28.08	8.18	3	2.96	124.49	0.85	0	0.85	31.87	8.44	0	3	1	1.24	2.91	31.86	-0.09	12.35	3
15	38.74	2.19	0.44	1.81	38.75	5.66	3	2.74	124.94	0.92	0	0.92	41.26	5.8	0	3	0.93	1.14	2.72	40.85	0.03	16.57	3
16	41.98	2.19	1.35	1.78	42	5.22	3	2.69	125.13	0.98	0	0.98	41.88	5.35	0	3	0.92	1.07	2.69	41.62	0.1	17.65	3
17	36.55	2.09	0.91	1.89	36.56	5.71	3	2.76	124.44	1.04	0	1.04	34.1	5.88	0	3	0.96	1.02	2.78	34.08	0.06	16.3	3
18	42.61	2.09	2.76	2.11	42.64	4.9	4	2.67	124.81	1.1	0	1.1	37.63	5.03	0	4	0.93	0.96	2.7	37.74	0.18	18.38	3
19	32.06	1.88	2.67	2.21	32.09	5.86	3	2.81	123.35	1.17	0	1.17	26.53	6.08	0.01	3	1	0.91	2.86	26.54	0.17	15.8	3
20	60.15	2.3	3.13	2.33	60.19	3.82	4	2.49	126.35	1.23	0	1.23	47.98	3.9	0	4	0.88	0.88	2.54	48.88	0.18	22.61	5
21	62.97	2.19	5.52	2.47	63.04	3.48	4	2.44	126.12	1.29	0	1.29	47.79	3.55	0.01	4	0.87	0.84	2.51	49.07	0.31	24.18	5
22	43.55	2.19	4.2	2.65	43.6	5.03	4	2.67	125.22	1.35	0	1.35	31.18	5.19	0.01	3	0.97	0.79	2.76	31.44	0.22	17.77	3
23	37.7	2.09	5.19	2.82	37.76	5.53	3	2.74	124.52	1.42	0	1.42	25.65	5.75	0.01	3	1	0.75	2.86	25.65	0.26	16.4	3
24	36.24	1.88	8.98	2.94	36.35	5.17	3	2.73	123.65	1.48	0	1.48	23.58	5.39	0.02	3	1	0.72	2.86	23.58	0.44	17.04	3
25	55.66	0	13.13	2.88	55.82	0	0	0	87.36	1.52	0	1.52	35.67	0	0.02	0	1	0.7	4.06	35.67	0.62	65.24	0

Depth (ft)	CPT-13 In situ data				Basic output data																		
	qc (tsf)	fs (tsf)	u (psi)	Other	qt (tsf)	Rf(%)	SBT	Ic.SBT	\bar{a} (pcf)	\acute{o},v (tsf)	u0 (tsf)	$\acute{o}',v\acute{o}$ (tsf)	Qt1	Fr (%)	Bq	SBTn	n	Cn	Ic	Qtn	U2	l(B)	Mod. SBTn
1	59	2.09	-0.98	-1.37	58.99	3.54	4	2.47	125.6	0.06	0	0.06	937.67	3.54	0	8	0.62	5.78	2.01	321.9	-1.12	27.41	5
2	43.44	1.46	-0.69	-1.83	43.43	3.37	4	2.55	122.25	0.12	0	0.12	349.25	3.38	0	8	0.67	4.22	2.14	172.71	-0.4	27.98	5
3	30.18	1.25	-1.06	-1.78	30.17	4.15	4	2.73	120.23	0.18	0	0.18	162.98	4.18	0	9	0.75	3.71	2.34	105.16	-0.42	22.6	5
4	26.94	1.04	-1.26	-1.76	26.93	3.88	4	2.74	118.62	0.24	0	0.24	109.67	3.91	0	4	0.77	3.12	2.4	78.78	-0.37	23.47	5
5	29.03	1.36	-1.35	-1.85	29.01	4.68	3	2.78	120.72	0.3	0	0.3	94.53	4.73	0	4	0.81	2.74	2.48	74.41	-0.32	20.01	3
6	31.54	1.36	-1.35	-1.8	31.52	4.31	4	2.72	120.92	0.36	0	0.36	85.54	4.36	0	4	0.81	2.37	2.47	69.71	-0.27	21.33	3
7	32.27	1.46	-0.89	-1.83	32.26	4.53	4	2.73	121.52	0.43	0	0.43	74.9	4.59	0	4	0.83	2.13	2.51	63.97	-0.15	20.33	3
8	36.03	1.67	-0.97	-1.82	36.02	4.64	4	2.7	122.77	0.49	0	0.49	73.07	4.7	0	4	0.83	1.91	2.52	64.15	-0.14	19.95	3
9	35.09	1.57	-1.07	-1.68	35.07	4.47	4	2.7	122.23	0.55	0	0.55	63.07	4.54	0	4	0.84	1.74	2.54	56.93	-0.14	20.39	3
10	30.28	1.46	-0.87	-1.56	30.27	4.83	3	2.77	121.37	0.61	0	0.61	48.78	4.93	0	4	0.88	1.63	2.63	45.71	-0.1	18.87	3
11	39.16	1.57	-0.81	-1.44	39.15	4	4	2.63	122.5	0.67	0	0.67	57.48	4.07	0	4	0.84	1.47	2.53	53.53	-0.09	22.07	5
12	41.04	1.88	-0.82	-1.14	41.03	4.58	4	2.66	123.95	0.73	0	0.73	55.1	4.66	0	4	0.87	1.38	2.58	52.43	-0.08	19.85	3
13	40.41	2.3	-0.64	-0.69	40.41	5.69	3	2.73	125.38	0.79	0	0.79	49.89	5.8	0	3	0.9	1.3	2.67	48.53	-0.06	16.65	3
14	55.24	2.72	-0.89	-0.61	55.23	4.92	4	2.59	127.36	0.86	0	0.86	63.4	4.99	0	4	0.86	1.2	2.55	61.59	-0.07	18.96	3
15	66.83	3.55	-0.64	-0.57	66.83	5.31	4	2.56	129.79	0.92	0	0.92	71.43	5.39	0	9	0.86	1.13	2.54	70.08	-0.05	17.89	3
16	108.92	5.01	-0.9	-0.59	108.91	4.6	9	2.38	133.51	0.99	0	0.99	109.07	4.64	0	9	0.8	1.06	2.37	107.62	-0.07	20.64	3
17	99.52	5.85	-0.39	-0.93	99.51	5.88	9	2.49	134.41	1.06	0	1.06	93.18	5.94	0	9	0.85	1	2.5	93.16	-0.03	16.55	3
18	90.33	4.8	-1.16	-0.91	90.32	5.32	9	2.48	132.74	1.12	0	1.12	79.43	5.39	0	9	0.86	0.95	2.5	80.11	-0.07	17.97	3
19	126.25	4.8	-1.02	-0.95	126.24	3.81	8	2.28	133.55	1.19	0	1.19	105.11	3.84	0	8	0.79	0.91	2.31	107.79	-0.06	24.33	5
20	99.73	5.22	-0.63	-0.83	99.72	5.24	9	2.45	133.59	1.26	0	1.26	78.36	5.3	0	9	0.86	0.86	2.5	80.26	-0.04	18.21	3
21	94.4	4.8	-0.7	-0.95	94.39	5.09	9	2.45	132.85	1.32	0	1.32	70.35	5.16	0	9	0.87	0.82	2.52	72.41	-0.04	18.57	3
22	117.9	5.33	-1.06	-1.22	117.89	4.52	9	2.35	134.14	1.39	0	1.39	83.8	4.57	0	9	0.84	0.8	2.42	87.57	-0.06	20.74	3
23	113.83	5.74	-0.21	-1.54	113.82	5.05	9	2.4	134.61	1.46	0	1.46	77.11	5.11	0	9	0.87	0.76	2.48	80.51	-0.01	18.8	3
24	83.23	4.59	-0.75	-1.85	83.22	5.52	9	2.52	132.21	1.52	0	1.52	53.63	5.62	0	4	0.92	0.71	2.62	55.2	-0.04	17.14	3
25	76.65	4.49	-1.21	-1.99	76.63	5.86	9	2.56	131.84	1.59	0	1.59	47.22	5.98	0	3	0.95	0.68	2.68	48.27	-0.05	16.24	3
26	82.92	3.86	-0.87	-1.97	82.9	4.66	9	2.46	130.94	1.65	0	1.65	49.1	4.76	0	4	0.92	0.66	2.59	51	-0.04	19.52	3
27	104.84	4.59	-0.39	-2.01	104.84	4.38	9	2.37	132.78	1.72	0	1.72	59.91	4.46	0	4	0.89	0.65	2.51	63.32	-0.02	20.82	3
28	100.77	4.59	-0.63	-2.11	100.76	4.56	9	2.4	132.68	1.79	0	1.79	55.37	4.64	0	4	0.9	0.62	2.54	58.24	-0.03	20.05	3
29	70.49	4.7	-0.68	-2.04	70.48	6.67	9	2.62	131.97	1.85	0	1.85	37.03	6.85	0	3	1	0.57	2.8	37.03	-0.03	14.53	3
30	91.06	0	-0.84	-2.15	91.05	0	0	0	87.36	1.9	0	1.9	46.99	0	0	0	1	0.56	4.06	46.99	-0.03	81.42	0

Depth (ft)	CPT-14 In situ data				Basic output data																		
	qc (tsf)	fs (tsf)	u (psi)	Other	qt (tsf)	Rf(%)	SBT	Ic SBT	\bar{a} (pcf)	δ_v (tsf)	u0 (tsf)	δ'_v (tsf)	Qt1	Fr (%)	Bq	SBTn	n	Cn	Ic	Qtn	U2	(B)	Mod. SBTn
1	73.1	2.09	0.87	-1.22	73.11	2.86	5	2.34	126.13	0.06	0	0.06	1157.5	2.86	0	8	0.58	5.16	1.91	356.37	0.99	33.64	7
2	62.66	2.19	-0.49	-1.01	62.65	3.5	4	2.45	126.11	0.13	0	0.13	495.43	3.51	0	8	0.65	3.97	2.08	234.72	-0.28	27.4	5
3	41.35	1.88	-1.74	-0.87	41.33	4.55	4	2.66	123.97	0.19	0	0.19	218.83	4.57	0	9	0.73	3.56	2.3	138.36	-0.67	21.13	3
4	58.79	1.67	-0.24	-0.79	58.79	2.84	5	2.4	123.96	0.25	0	0.25	234.12	2.85	0	5	0.67	2.63	2.13	145.51	-0.07	32.04	7
5	90.54	1.36	0.97	-0.85	90.55	1.5	5	2.08	123.5	0.31	0	0.31	289.38	1.5	0	6	0.57	2.02	1.86	171.97	0.22	55.36	7
6	35.71	1.67	-0.33	-0.91	35.71	4.68	4	2.71	122.75	0.37	0	0.37	94.67	4.73	0	9	0.81	2.32	2.47	77.47	-0.06	20.05	3
7	58.9	1.36	0.07	-1	58.9	2.3	5	2.34	122.45	0.43	0	0.43	134.55	2.32	0	5	0.69	1.85	2.16	102.25	0.01	36.51	7
8	26.63	1.46	0.65	-1.79	26.64	5.49	3	2.85	121.06	0.49	0	0.49	52.82	5.59	0	4	0.89	1.96	2.66	48.42	0.09	17.14	3
9	25.9	1.46	-2.55	-1.9	25.87	5.65	3	2.87	120.98	0.56	0	0.56	45.57	5.78	-0.01	3	0.91	1.79	2.7	42.9	-0.33	16.65	3
10	24.96	1.46	-1.62	-1.99	24.94	5.86	3	2.89	120.9	0.62	0	0.62	39.49	6.01	0	3	0.93	1.65	2.75	37.97	-0.19	16.08	3
11	24.33	1.25	-0.93	-2.05	24.32	5.15	3	2.86	119.71	0.68	0	0.68	34.99	5.3	0	3	0.93	1.52	2.75	33.89	-0.1	17.58	3
12	26.73	1.25	-2.1	-2.13	26.71	4.69	3	2.8	119.93	0.74	0	0.74	35.3	4.82	-0.01	4	0.92	1.4	2.71	34.27	-0.21	18.81	3
13	28.2	1.25	-2.03	-2.14	28.17	4.45	3	2.77	120.06	0.8	0	0.8	34.4	4.58	-0.01	4	0.92	1.3	2.7	33.61	-0.18	19.48	3
14	30.18	1.36	-1.35	-2.13	30.16	4.5	3	2.75	120.82	0.86	0	0.86	34.23	4.63	0	4	0.92	1.22	2.71	33.67	-0.11	19.33	3
15	35.3	1.46	-0.97	-2.09	35.28	4.14	4	2.68	121.74	0.92	0	0.92	37.48	4.25	0	4	0.9	1.14	2.65	36.97	-0.08	20.67	3
16	36.24	1.36	-0.39	-2.09	36.23	3.75	4	2.64	121.26	0.98	0	0.98	36.06	3.85	0	4	0.9	1.07	2.63	35.77	-0.03	22.03	5
17	36.65	1.67	-0.29	-2.11	36.65	4.56	4	2.69	122.81	1.04	0	1.04	34.27	4.69	0	4	0.93	1.02	2.71	34.23	-0.02	19.18	3
18	48.25	1.88	-0.35	-2.15	48.24	3.9	4	2.56	124.34	1.1	0	1.1	42.81	3.99	0	4	0.89	0.97	2.59	43	-0.02	21.95	3
19	30.81	1.04	0.97	-2.15	30.82	3.39	4	2.66	118.95	1.16	0	1.16	25.55	3.52	0	4	0.94	0.92	2.71	25.7	0.06	22.24	5
20	24.64	0.94	0.78	-2.11	24.65	3.81	4	2.77	117.63	1.22	0	1.22	19.22	4.01	0	3	0.99	0.87	2.85	19.24	0.05	19.87	3
21	18.8	0.63	0.75	-2.11	18.81	3.33	3	2.82	114.01	1.28	0	1.28	13.73	3.57	0	3	1	0.83	2.93	13.73	0.04	19.93	3
22	9.82	0.42	0.61	-2.13	9.82	4.25	3	3.11	109.46	1.33	0	1.33	6.38	4.92	0.01	3	1	0.79	3.28	6.38	0.03	16.16	2
23	16.5	0.42	0.97	-2.2	16.51	2.53	4	2.8	110.72	1.39	0	1.39	10.91	2.76	0	3	1	0.76	2.95	10.91	0.05	20.88	2
24	19.11	0.52	0.44	-2.37	19.12	2.73	4	2.76	112.71	1.44	0	1.44	12.25	2.95	0	3	1	0.73	2.92	12.25	0.02	20.95	2
25	20.47	0.84	0.26	-2.31	20.47	4.08	3	2.85	116.32	1.5	0	1.5	12.64	4.4	0	3	1	0.7	3.01	12.64	0.01	18.02	3
26	36.13	1.78	-4.15	-2.1	36.08	4.92	3	2.72	123.22	1.56	0	1.56	22.09	5.14	-0.01	3	1	0.68	2.87	22.09	-0.19	17.48	3
27	49.81	2.3	-4.08	-1.87	49.76	4.62	4	2.6	125.89	1.63	0	1.63	29.61	4.77	-0.01	3	0.98	0.66	2.75	29.92	-0.18	18.76	3
28	71.43	2.3	-4.22	-1.58	71.38	3.22	5	2.38	126.77	1.69	0	1.69	41.26	3.3	0	4	0.89	0.66	2.53	43.39	-0.18	25.06	5
29	69.86	2.4	-4.17	-1.47	69.81	3.44	4	2.41	127.04	1.75	0	1.75	38.83	3.53	0	4	0.91	0.63	2.57	40.61	-0.17	23.73	5
30	95.97	3.24	-3.93	-1.22	95.92	3.37	5	2.31	130	1.82	0	1.82	51.77	3.44	0	4	0.87	0.62	2.46	55.4	-0.16	25.1	5
31	80.1	3.03	-3.96	-0.97	80.05	3.78	4	2.4	129.07	1.88	0	1.88	41.53	3.87	0	4	0.92	0.59	2.57	43.49	-0.15	22.43	5
32	131.68	4.28	-3.57	-0.56	131.64	3.25	5	2.21	132.81	1.95	0	1.95	66.56	3.3	0	5	0.84	0.6	2.37	73.22	-0.13	26.7	5
33	99.94	5.64	-3	-0.1	99.9	5.64	9	2.47	134.16	2.02	0	2.02	48.57	5.76	0	3	0.96	0.54	2.66	49.9	-0.11	16.76	3
34	73.62	3.24	-2.7	0.02	73.59	4.4	4	2.47	129.35	2.08	0	2.08	34.37	4.53	0	4	0.97	0.52	2.69	35.01	-0.09	19.7	3
35	51.27	3.03	-3.22	0.06	51.23	5.91	3	2.67	127.98	2.14	0	2.14	22.89	6.17	0	3	1	0.49	2.91	22.89	-0.11	15.57	3
36	132.2	4.91	-2.99	0.39	132.17	3.71	8	2.26	133.82	2.21	0	2.21	58.77	3.78	0	4	0.89	0.52	2.45	63.8	-0.1	23.73	5
37	211.78	6.06	-2.9	1.23	211.74	2.86	8	2.04	136.51	2.28	0	2.28	91.89	2.89	0	5	0.8	0.54	2.21	107.03	-0.09	30.84	5
38	246.24	7.83	-0.97	1.36	246.23	3.18	8	2.05	137.28	2.35	0	2.35	103.87	3.21	0	5	0.8	0.53	2.21	121.37	-0.03	28.57	5
39	99.94	6.68	-0.29	1.05	99.93	6.69	9	2.53	135.4	2.42	0	2.42	40.37	6.85	0	3	1	0.44	2.78	40.37	-0.01	14.53	3
40	96.8	4.28	0.61	1.15	96.81	4.42	9	2.4	132.07	2.48	0	2.48	38.01	4.54	0	4	0.98	0.43	2.66	38.65	0.02	19.82	3
41	113.72	4.18	-0.2	1.38	113.72	3.67	5	2.29	132.28	2.55	0	2.55	43.63	3.76	0	4	0.94	0.44	2.55	45.93	-0.01	23.06	5
42	74.67	3.03	0.33	1.42	74.67	4.06	4	2.44	128.9	2.61	0	2.61	27.58	4.2	0	4	1	0.41	2.74	27.58	0.01	20.21	3
43	83.23	3.76	0.57	1.39	83.24	4.52	4	2.45	130.75	2.68	0	2.68	30.08	4.67	0	3	1	0.4	2.75	30.08	0.02	19.05	3
44	162.8	5.74	0.48	1.87	162.81	3.53	8	2.18	135.48	2.75	0	2.75	58.3	3.59	0	4	0.91	0.42	2.43	63.63	0.01	24.68	5
45	144.74	4.28	0.71	2.28	144.74	2.96	5	2.15	133.05	2.81	0	2.81	50.47	3.02	0	5	0.91	0.41	2.42	55.26	0.02	27.57	5
46	122.81	4.91	0.72	2.49	122.82	4	8	2.3	133.65	2.88	0	2.88	41.66	4.09	0	4	0.98	0.38	2.6	42.69	0.02	21.53	3
47	119.78	6.37	1.74	2.53	119.8	5.32	9	2.41	135.49	2.95	0	2.95	39.66	5.45	0	3	1	0.36	2.71	39.66	0.04	17.35	3
48	77.69	6.37	3.16	2.6	77.73	8.19	9	2.67	134.44	3.01	0	3.01	24.79	8.53	0	3	1	0.35	2.99	24.79	0.08	12.37	3
49	93.88	5.74	1.69	2.72	93.9	6.12	9	2.52	134.14	3.08	0	3.08	29.48	6.32	0	3	1	0.34	2.84	29.48	0.04	15.4	3
50	124.79	0	1.74	2.98	124.81	0	0	0	87.36	3.12	0	3.12	38.95	0	0	0	1	0.34	4.06	38.95	0.04	69.92	0

Depth (ft)	CPT-15 In situ data					Basic output data																	
	qc (tsf)	fs (tsf)	u (psi)	Other	qt (tsf)	Rf(%)	SBT	Ic SBT	\bar{a} (pcf)	ϕ_v (tsf)	u0 (tsf)	ϕ'_v (tsf)	Qt1	Fr (%)	Bq	SBTn	n	Cn	Ic	Qtn	U2	(B)	Mod. SBTn
1	53.36	2.19	2.03	0.63	53.39	4.11	4	2.55	125.72	0.06	0	0.06	847.76	4.11	0	8	0.65	6.18	2.08	311.63	2.32	23.8	5
2	62.55	1.36	1.35	0.67	62.57	2.17	5	2.3	122.6	0.12	0	0.12	502.61	2.17	0	6	0.59	3.57	1.93	210.45	0.78	41.79	7
3	56.91	1.36	1.32	0.45	56.93	2.38	5	2.36	122.37	0.19	0	0.19	306.29	2.39	0	5	0.63	3.02	2.04	162.1	0.51	37.59	7
4	13.99	1.25	1.37	0.39	14.01	8.94	3	3.2	118.36	0.24	0	0.24	56.31	9.1	0.01	3	0.93	3.9	2.8	50.78	0.4	11.42	3
5	21.93	1.25	1.16	0.18	21.94	5.71	3	2.92	119.46	0.3	0	0.3	71.13	5.79	0	4	0.86	2.91	2.61	59.57	0.27	16.77	3
6	22.77	0.94	1.32	0.04	22.78	4.13	3	2.82	117.44	0.36	0	0.36	61.76	4.19	0	4	0.84	2.45	2.54	51.84	0.26	21.52	3
7	26.94	1.15	1.06	0.11	26.96	4.26	3	2.77	119.32	0.42	0	0.42	62.77	4.33	0	4	0.84	2.16	2.54	54.11	0.18	21.07	3
8	26.32	1.46	1.06	0.05	26.33	5.55	3	2.86	121.03	0.48	0	0.48	53.5	5.66	0	3	0.89	2	2.66	48.9	0.16	16.99	3
9	21.09	1.36	1.07	-0.14	21.11	6.43	3	2.97	119.95	0.54	0	0.54	37.87	6.6	0	3	0.94	1.87	2.79	36.39	0.14	14.95	3
10	22.87	1.25	0.97	-0.12	22.88	5.48	3	2.9	119.56	0.6	0	0.6	36.95	5.62	0	3	0.93	1.68	2.75	35.47	0.12	16.87	3
11	26.63	1.46	1.06	0.08	26.64	5.49	3	2.85	121.06	0.66	0	0.66	39.16	5.63	0	3	0.92	1.54	2.73	37.77	0.12	16.91	3
12	35.71	1.57	1.25	0.04	35.73	4.38	4	2.69	122.28	0.72	0	0.72	48.31	4.47	0	4	0.88	1.39	2.6	46.08	0.12	20.3	3
13	13.99	1.46	0.92	-0.02	14	10.44	3	3.24	119.49	0.78	0	0.78	16.86	11.06	0.01	3	1	1.35	3.19	16.86	0.08	10.47	2
14	42.82	1.46	1.06	0.11	42.83	3.41	4	2.56	122.21	0.85	0	0.85	49.66	3.48	0	4	0.85	1.21	2.51	47.98	0.09	24.46	5
15	25.69	0.84	1.12	0.06	25.7	3.25	4	2.71	116.87	0.9	0	0.9	27.44	3.37	0	4	0.92	1.16	2.68	27.07	0.09	23	5
16	25.79	0.52	1.16	0.13	25.81	2.02	4	2.58	113.44	0.96	0	0.96	25.87	2.1	0	4	0.88	1.09	2.58	25.56	0.09	28.74	5
17	53.26	1.04	1.32	0.16	53.27	1.96	5	2.33	120.28	1.02	0	1.02	51.19	2	0	5	0.79	1.03	2.33	50.8	0.09	35.45	7
18	109.86	1.15	1.53	-0.37	109.88	1.05	6	1.91	122.75	1.08	0	1.08	100.55	1.06	0	6	0.63	0.99	1.92	101.38	0.1	62.91	7
19	54.2	0.84	1.45	-0.36	54.22	1.54	5	2.25	118.69	1.14	0	1.14	46.5	1.57	0	5	0.78	0.94	2.29	47.3	0.09	39.67	7
20	19.42	0.52	1.45	-0.33	19.44	2.69	4	2.75	112.75	1.2	0	1.2	15.23	2.86	0.01	4	0.99	0.88	2.84	15.26	0.09	22.22	4
21	7.21	0.52	1.45	-0.28	7.22	7.23	3	3.36	110.34	1.25	0	1.25	4.76	8.75	0.02	2	1	0.84	3.53	4.76	0.08	13.22	2
22	33.1	0.73	1.54	-0.13	33.12	2.21	4	2.52	116.52	1.31	0	1.31	24.26	2.3	0	4	0.91	0.82	2.61	24.75	0.08	27.39	5
23	8.56	0.42	1.54	-0.12	8.58	4.87	3	3.19	109.13	1.37	0	1.37	5.28	5.79	0.02	3	1	0.77	3.39	5.28	0.08	15.19	2
24	4.28	0.21	1.64	-0.16	4.3	4.86	3	3.44	102.37	1.42	0	1.42	2.04	7.24	0.04	2	1	0.75	3.78	2.04	0.08	14.2	2
25	6.68	0.21	2.03	-0.12	6.71	3.11	3	3.17	103.45	1.47	0	1.47	3.57	3.99	0.03	3	1	0.72	3.44	3.57	0.1	16.11	2
26	5.22	0.1	2.12	-0.09	5.25	1.99	3	3.16	97.78	1.52	0	1.52	2.46	2.8	0.04	3	1	0.7	3.5	2.46	0.1	16.2	2
27	16.6	0.42	1.72	-0.02	16.63	2.51	4	2.79	110.74	1.57	0	1.57	9.57	2.78	0.01	3	1	0.67	2.99	9.57	0.08	20.27	2
28	19.21	0.63	1.78	0.06	19.24	3.26	4	2.81	114.06	1.63	0	1.63	10.8	3.56	0.01	3	1	0.65	3.01	10.8	0.08	19.18	2
29	40.2	0.42	2.03	0.24	40.23	1.04	5	2.26	112.89	1.69	0	1.69	22.86	1.08	0	5	0.86	0.67	2.43	24.44	0.09	35.69	6
30	24.85	0.73	2.51	0.49	24.88	2.94	4	2.69	115.82	1.74	0	1.74	13.27	3.16	0.01	3	1	0.61	2.91	13.27	0.1	20.79	2
31	13.89	1.04	2.41	0.57	13.92	7.5	3	3.15	117.01	1.8	0	1.8	6.72	8.62	0.01	3	1	0.59	3.41	6.72	0.1	13.07	2
32	275.37	1.57	2.54	1.04	275.41	0.57	6	1.44	127.26	1.87	0	1.87	146.55	0.57	0	6	0.52	0.74	1.54	191.98	0.1	112.25	7
33	156.85	2.92	2.58	1.76	156.88	1.86	6	1.98	130.45	1.93	0	1.93	80.22	1.89	0	5	0.75	0.64	2.12	93.33	0.1	41.98	7
34	61.51	5.43	4.54	1.82	61.56	8.82	9	2.76	132.7	2	0	2	29.81	9.12	0.01	3	1	0.53	2.96	29.81	0.16	11.65	3
35	86.67	6.89	4.73	1.91	86.73	7.95	9	2.63	135.28	2.07	0	2.07	40.99	8.14	0	3	1	0.51	2.83	40.99	0.16	12.63	3
36	133.25	4.91	4.39	1.85	133.3	3.68	8	2.25	133.84	2.13	0	2.13	61.51	3.74	0	4	0.88	0.54	2.43	66.98	0.15	24.01	5
37	116.23	2.51	5.28	1.68	116.29	2.16	5	2.11	128.59	2.2	0	2.2	51.93	2.2	0	5	0.83	0.54	2.31	58.63	0.17	34.52	7
38	113.41	2.82	5.02	1.66	113.47	2.48	5	2.16	129.4	2.26	0	2.26	49.17	2.54	0	5	0.86	0.52	2.37	54.62	0.16	31	5
39	48.45	2.82	4.92	1.56	48.51	5.81	3	2.68	127.32	2.33	0	2.33	19.86	6.1	0.01	3	1	0.46	2.96	19.86	0.15	15.61	3
40	33.73	2.61	5.12	1.48	33.79	7.73	3	2.88	125.88	2.39	0	2.39	13.15	8.31	0.01	3	1	0.44	3.18	13.15	0.15	12.91	3
41	67.88	5.74	4.27	1.04	67.93	8.46	9	2.72	133.35	2.45	0	2.45	26.67	8.77	0	3	1	0.43	2.98	26.67	0.13	12.06	3
42	338.87	5.74	4.91	1.74	338.93	1.69	6	1.74	137.27	2.52	0	2.52	133.3	1.71	0	6	0.69	0.55	1.9	173.84	0.14	50.12	7
43	55.14	2.19	5.01	2.19	55.2	3.97	4	2.53	125.8	2.59	0	2.59	20.34	4.17	0.01	3	1	0.41	2.84	20.34	0.14	19.6	3
44	57.96	2.09	4.97	2.43	58.02	3.6	4	2.48	125.56	2.65	0	2.65	20.9	3.77	0.01	3	1	0.4	2.8	20.9	0.14	20.76	3
45	102.34	2.61	4.91	2.79	102.4	2.55	5	2.2	128.58	2.71	0	2.71	36.74	2.62	0	4	0.93	0.42	2.49	39.32	0.13	28.51	5
46	53.68	2.72	5.02	3.17	53.74	5.05	4	2.61	127.3	2.78	0	2.78	18.35	5.33	0.01	3	1	0.38	2.94	18.35	0.13	16.9	3
47	94.61	3.55	5.2	3.44	94.67	3.75	4	2.35	130.64	2.84	0	2.84	32.31	3.87	0	4	1	0.37	2.67	32.31	0.13	21.71	3
48	50.75	4.18	5.06	3.61	50.81	8.22	3	2.79	130.31	2.91	0	2.91	16.48	8.72	0.01	3	1	0.36	3.12	16.48	0.13	12.39	3
49	89.81	4.91	5.31	3.61	89.87	5.46	9	2.49	132.88	2.97	0	2.97	29.22	5.65	0	3	1	0.36	2.81	29.22	0.13	16.69	3
50	156.95	0	6.14	3.71	157.03	0	0	0	87.36	3.02	0	3.02	51.04	0	0	0	1	0.35	4.06	51.04	0.15	87.19	0

Depth (ft)	CPT-16 In situ data					Basic output data																	
	qc (tsf)	fs (tsf)	u (psi)	Other	qt (tsf)	Rf(%)	SBT	Ic SBT	ā (pcf)	ó,v (tsf)	u0 (tsf)	ó',vo (tsf)	Qt1	Fr (%)	Bq	SBTn	n	Cn	Ic	Qtn	U2	l(B)	Mod. SBTn
1	64.64	1.25	-0.17	0.19	64.64	1.94	5	2.26	122.09	0.06	0	0.06	1057.2	1.94	0	6	0.55	4.75	1.81	289.72	-0.2	47.41	7
2	42.5	1.25	-0.3	0.1	42.5	2.95	4	2.52	121.07	0.12	0	0.12	348.32	2.96	0	5	0.66	4.15	2.1	166.09	-0.18	31.38	5
3	28.93	1.78	0	0.07	28.93	6.14	3	2.86	122.68	0.18	0	0.18	157.21	6.18	0	9	0.8	4.05	2.47	110.12	0	16.01	3
4	62.13	3.13	-0.79	0.2	62.12	5.04	4	2.57	128.7	0.25	0	0.25	250.28	5.06	0	9	0.73	2.9	2.29	169.83	-0.23	19.34	3
5	61.09	3.65	-0.84	0.41	61.08	5.98	3	2.63	129.78	0.31	0	0.31	194.67	6.01	0	9	0.77	2.57	2.39	147.59	-0.19	16.46	3
6	236.42	3.13	2.32	0.26	236.45	1.32	6	1.75	131.96	0.38	0	0.38	624.23	1.33	0	6	0.48	1.65	1.62	367.25	0.44	67.69	7
7	61.09	3.03	3.93	-0.57	61.14	4.95	4	2.57	128.41	0.44	0	0.44	137.19	4.99	0	9	0.78	1.97	2.38	113.16	0.64	19.41	3
8	112.99	3.24	2.97	-0.56	113.03	2.86	5	2.21	130.4	0.51	0	0.51	221.73	2.88	0	5	0.67	1.63	2.08	173.59	0.42	32.24	7
9	46.26	2.19	2.78	-0.38	46.3	4.74	4	2.63	125.37	0.57	0	0.57	80.19	4.8	0	4	0.83	1.67	2.49	72.04	0.35	19.74	3
10	61.61	2.51	2.22	-0.16	61.64	4.07	4	2.5	127.05	0.63	0	0.63	96.26	4.11	0	4	0.79	1.5	2.39	86.46	0.25	22.69	5
11	67.88	3.03	2.66	-0.15	67.91	4.46	4	2.5	128.67	0.7	0	0.7	96.28	4.51	0	9	0.8	1.4	2.41	88.71	0.27	21.02	3
12	64.43	3.24	3.38	0.04	64.47	5.02	4	2.56	129.03	0.76	0	0.76	83.53	5.08	0	9	0.83	1.31	2.49	79.1	0.32	18.88	3
13	66.62	3.13	2.94	0.37	66.66	4.7	4	2.52	128.87	0.83	0	0.83	79.61	4.76	0	9	0.83	1.23	2.47	76.37	0.26	19.93	3
14	47.31	2.92	2.55	0.37	47.34	6.18	3	2.71	127.53	0.89	0	0.89	52.14	6.3	0	3	0.91	1.17	2.68	51.36	0.21	15.6	3
15	55.03	2.4	4.07	0.42	55.08	4.36	4	2.56	126.46	0.95	0	0.95	56.74	4.44	0.01	4	0.86	1.09	2.54	55.94	0.31	20.72	3
16	65.27	2.09	4.87	0.34	65.33	3.2	5	2.41	125.85	1.02	0	1.02	63.23	3.25	0.01	5	0.82	1.03	2.41	62.77	0.34	26.57	5
17	125.83	3.97	3.12	0.41	125.87	3.15	5	2.21	132.15	1.08	0	1.08	115.21	3.18	0	5	0.75	0.98	2.22	115.89	0.21	28.71	5
18	109.13	6.16	3.89	0.28	109.17	5.64	9	2.45	135.02	1.15	0	1.15	93.9	5.7	0	9	0.85	0.93	2.48	95.1	0.24	17.16	3
19	75.5	5.95	4.28	0.24	75.55	7.88	9	2.66	133.87	1.22	0	1.22	61.06	8.01	0	9	0.94	0.88	2.71	61.58	0.25	12.71	3
20	93.57	4.07	2.93	0.57	93.6	4.35	9	2.4	131.62	1.28	0	1.28	71.94	4.41	0	4	0.85	0.85	2.46	74.1	0.16	21.19	3
21	73.93	3.24	2.9	0.49	73.97	4.38	4	2.47	129.36	1.35	0	1.35	53.87	4.46	0	4	0.88	0.81	2.54	55.42	0.15	20.63	3
22	65.58	3.45	2.9	0.36	65.62	5.25	4	2.56	129.53	1.41	0	1.41	45.44	5.37	0	4	0.93	0.76	2.66	46.39	0.15	17.68	3
23	80.83	3.13	4.5	0.37	80.88	3.87	4	2.41	129.34	1.48	0	1.48	53.75	3.95	0	4	0.87	0.75	2.5	56.07	0.22	22.69	5
24	79.57	4.07	3.87	0.4	79.62	5.12	9	2.5	131.22	1.54	0	1.54	50.6	5.22	0	4	0.92	0.71	2.61	52.19	0.18	18.17	3
25	98.89	3.55	4.16	0.34	98.94	3.59	5	2.32	130.75	1.61	0	1.61	60.52	3.65	0	4	0.85	0.7	2.44	64.32	0.19	24.4	5
26	89.49	3.03	3.35	0.3	89.54	3.38	5	2.33	129.34	1.67	0	1.67	52.51	3.45	0	4	0.87	0.67	2.46	55.81	0.14	25.08	5
27	76.65	2.82	4.06	0.2	76.7	3.68	4	2.4	128.44	1.74	0	1.74	43.15	3.76	0	4	0.9	0.64	2.55	45.23	0.17	23	5
28	53.78	2.61	4.48	0.18	53.83	4.85	4	2.6	127.01	1.8	0	1.8	28.9	5.02	0.01	3	0.99	0.59	2.78	28.99	0.18	18.1	3
29	86.67	4.18	5.62	0.28	86.74	4.82	9	2.46	131.62	1.87	0	1.87	45.47	4.92	0	4	0.94	0.59	2.62	47.1	0.22	18.92	3
30	79.26	5.85	4.64	0.52	79.32	7.37	9	2.63	133.86	1.93	0	1.93	40.02	7.56	0	3	1	0.55	2.81	40.02	0.17	13.43	3
31	149.12	5.01	5.65	0.91	149.19	3.36	8	2.19	134.27	2	0	2	73.57	3.41	0	5	0.84	0.59	2.35	81.56	0.2	26.33	5
32	125.42	3.76	4.25	0.87	125.47	3	5	2.2	131.75	2.07	0	2.07	59.71	3.05	0	5	0.85	0.57	2.37	65.95	0.15	28.03	5
33	115.81	3.34	4.32	1.36	115.86	2.88	5	2.21	130.69	2.13	0	2.13	53.35	2.94	0	5	0.86	0.55	2.4	58.68	0.15	28.33	5
34	82.18	4.49	3.12	1.78	82.22	5.46	9	2.52	132.02	2.2	0	2.2	36.41	5.61	0	3	1	0.48	2.74	36.45	0.1	16.92	3
35	133.98	6.58	3.59	2.15	134.02	4.91	9	2.35	136	2.27	0	2.27	58.15	4.99	0	4	0.93	0.49	2.55	61.35	0.11	18.96	3
36	170.84	6.47	5.93	2.21	170.92	3.79	8	2.2	136.48	2.33	0	2.33	72.22	3.84	0	4	0.87	0.5	2.39	79.99	0.18	23.86	5
37	143.07	8.25	4.7	2.16	143.12	5.76	9	2.39	137.28	2.4	0	2.4	58.56	5.86	0	4	0.96	0.46	2.61	60.65	0.14	16.6	3
38	102.34	7	4.46	1.95	102.39	6.83	9	2.53	135.8	2.47	0	2.47	40.45	7	0	3	1	0.43	2.78	40.45	0.13	14.28	3
39	159.98	7.83	4.47	1.86	160.04	4.89	9	2.3	137.28	2.54	0	2.54	62.03	4.97	0	4	0.93	0.44	2.53	65.67	0.13	19.08	3
40	206.66	9.19	5	1.8	206.72	4.45	9	2.21	137.28	2.61	0	2.61	78.27	4.5	0	9	0.9	0.45	2.42	85.88	0.14	21	3
41	165.2	9.19	5.06	1.9	165.27	5.56	9	2.34	137.28	2.68	0	2.68	60.74	5.65	0	4	0.96	0.41	2.58	62.94	0.14	17.13	3
42	359.02	8.56	6.62	1.87	359.1	2.38	8	1.85	137.28	2.75	0	2.75	129.81	2.4	0	5	0.75	0.49	2.03	163.96	0.17	37.49	7
43	313.8	12.11	18.71	1.79	314.03	3.86	8	2.06	137.28	2.81	0	2.81	110.61	3.89	0	8	0.85	0.44	2.26	128.59	0.48	24.29	5
44	464.28	13.78	24.39	2.58	464.58	2.97	8	1.88	137.28	2.88	0	2.88	160.18	2.99	0	8	0.77	0.46	2.06	201.68	0.61	31.49	5
45	270.57	10.76	72.4	2.06	271.46	3.96	8	2.1	137.28	2.95	0	2.95	90.98	4.01	0.02	9	0.88	0.41	2.33	103.05	1.77	23.42	5
46	110.9	7.52	59.93	1.67	111.64	6.74	9	2.51	136.53	3.02	0	3.02	35.97	6.92	0.04	3	1	0.35	2.81	35.97	1.43	14.41	3
47	106.83	5.12	62.72	1.32	107.6	4.76	9	2.4	133.63	3.09	0	3.09	33.86	4.9	0.04	3	1	0.34	2.72	33.86	1.46	18.6	3
48	110.8	5.33	56.91	1.2	111.49	4.78	9	2.39	134.01	3.15	0	3.15	34.36	4.92	0.04	3	1	0.34	2.72	34.36	1.3	18.57	3
49	66.73	4.59	54.23	1.26	67.39	6.82	9	2.64	131.7	3.22	0	3.22	19.94	7.16	0.06	3	1	0.33	3	19.94	1.21	14.07	3
50	92.73	5.95	52.46	1.34	93.37	6.37	9	2.53	134.39	3.29	0	3.29	27.41	6.61	0.04	3	1	0.32	2.88	27.41	1.15	14.9	3
51	101.82	5.95	46.88	1.53	102.39	5.81	9	2.48	134.61	3.35	0	3.35	29.53	6.01	0.03	3	1	0.32	2.83	29.53	1.01	15.97	3
52	82.6	3.45	54.09	1.68	83.26	4.14	4	2.42	130.11	3.42	0	3.42	23.36	4.32	0.05	3	1	0.31	2.8	23.36	1.14	19.53	3
53	114.35	4.18	48.06	2.12	114.94	3.63	5	2.29	132.3	3.48	0	3.48	31.98	3.75	0.03	4	1	0.3	2.66	31.98	0.99	22.11	5
54	134.71	5.12	52.89	2.51	135.36	3.78	8	2.26	134.19	3.55	0	3.55	37.11	3.88	0.03	4	1	0.3	2.62	37.11	1.07	22.01	5
55	106.52	5.22	55.08	2.74	107.19	4.87	9	2.4	133.77	3.62	0	3.62	28.62	5.04	0.04	3	1	0.29	2.78	28.62	1.1	18.02	3
56	142.23	4.91	58.26	2.9	142.94	3.43	8	2.21	134.02	3.69	0	3.69	37.78	3.52	0.03	4	1	0.29	2.59	37.78	1.14	23.52	5
57	122.39	6.58	60.48	2.99	123.13	5.34	9	2.4	135.8	3.75	0	3.75	31.8	5.51	0.04	3	1	0.28	2.78	31.8	1.16	17.04	3
58	221.8	9.19	68	3.22	222.64	4.13	8	2.16	137.28	3.82													

Depth (ft)	CPT-17 In situ data				Basic output data																		
	qc (tsf)	fs (tsf)	u (psi)	Other	qt (tsf)	Rf(%)	SBT	Ic.SBT	\bar{a} (pcf)	\dot{o},v (tsf)	u0 (tsf)	\dot{o}',vo (tsf)	Qt1	Fr (%)	Bq	SBTn	n	Cn	Ic	Qtn	U2	(B)	Mod. SBTn
1	65.27	1.36	0.37	-1.06	65.27	2.08	5	2.28	122.7	0.06	0	0.06	1062.2	2.08	0	6	0.55	4.83	1.83	297.66	0.43	44.61	7
2	89.6	2.82	1.15	-1.45	89.61	3.15	5	2.31	128.82	0.13	0	0.13	711.1	3.15	0	8	0.61	3.66	1.98	309.83	0.66	30.57	5
3	101.92	4.7	-0.36	-1.82	101.92	4.61	9	2.4	132.87	0.19	0	0.19	529.53	4.62	0	8	0.67	3.13	2.13	301.32	-0.14	21.29	3
4	132.94	4.59	-1.06	-2.04	132.92	3.46	8	2.23	133.36	0.26	0	0.26	512.56	3.46	0	8	0.63	2.43	2.02	304.51	-0.3	27.96	5
5	94.72	4.28	-0.44	-2.15	94.71	4.52	9	2.41	132.01	0.32	0	0.32	290.53	4.54	0	9	0.71	2.3	2.21	205.12	-0.1	21.5	3
6	69.24	3.97	-0.66	-2.09	69.23	5.73	4	2.58	130.69	0.39	0	0.39	176.39	5.76	0	9	0.78	2.17	2.38	140.98	-0.12	17.1	3
7	104.74	2.92	-0.65	-2.12	104.73	2.79	5	2.22	129.47	0.46	0	0.46	229.16	2.8	0	5	0.66	1.75	2.07	172.25	-0.1	32.96	7
8	73.52	3.55	-0.54	-2.22	73.51	4.83	4	2.51	130.02	0.52	0	0.52	140.4	4.86	0	9	0.77	1.73	2.36	119.58	-0.07	19.88	3
9	90.75	2.92	-0.19	-2.36	90.74	3.22	5	2.31	129.12	0.58	0	0.58	154.26	3.24	0	5	0.72	1.53	2.2	130.26	-0.02	28.48	5
10	77.48	2.4	0.1	-2.51	77.49	3.1	5	2.35	127.29	0.65	0	0.65	118.55	3.13	0	5	0.74	1.43	2.25	104.2	0.01	28.86	5
11	84.9	2.72	0.03	-2.57	84.9	3.2	5	2.33	128.41	0.71	0	0.71	118.17	3.23	0	5	0.74	1.34	2.25	106.68	0	28.18	5
12	60.46	2.72	0.09	-2.6	60.46	4.49	4	2.54	127.58	0.78	0	0.78	76.89	4.55	0	4	0.83	1.29	2.47	72.92	0.01	20.64	3
13	77.9	3.24	-0.73	-2.6	77.89	4.16	4	2.44	129.49	0.84	0	0.84	91.64	4.2	0	4	0.8	1.2	2.39	87.56	-0.06	22.28	5
14	70.7	3.34	-0.09	-2.8	70.7	4.73	4	2.51	129.49	0.91	0	0.91	77.06	4.79	0	4	0.84	1.14	2.48	75.14	-0.01	19.81	3
15	77.9	2.51	0.18	-2.96	77.9	3.22	5	2.36	127.62	0.97	0	0.97	79.36	3.26	0	5	0.79	1.07	2.34	77.91	0.01	27.15	5
16	83.96	2.3	-0.27	-3.28	83.96	2.74	5	2.28	127.16	1.03	0	1.03	80.27	2.77	0	5	0.77	1.02	2.29	79.83	-0.02	30.85	5
17	77.38	2.51	0.19	-3.97	77.38	3.24	5	2.36	127.6	1.1	0	1.1	69.55	3.29	0	5	0.81	0.97	2.38	70.03	0.01	26.67	5
18	81.77	2.4	0.11	-4.56	81.77	2.94	5	2.31	127.42	1.16	0	1.16	69.46	2.98	0	5	0.8	0.93	2.34	70.77	0.01	28.76	5
19	94.82	2.82	0.01	-5.35	94.82	2.97	5	2.27	128.96	1.22	0	1.22	76.4	3.01	0	5	0.79	0.89	2.32	78.79	0	28.89	5
20	94.4	2.92	0.58	-5.86	94.41	3.1	5	2.29	129.21	1.29	0	1.29	72.21	3.14	0	5	0.8	0.85	2.34	75.06	0.03	27.83	5
21	125.52	3.03	0.97	-6.57	125.53	2.41	5	2.13	130.17	1.35	0	1.35	91.66	2.44	0	5	0.75	0.83	2.19	97.58	0.05	34.93	7
22	111.42	2.61	1.16	-6.63	111.44	2.34	5	2.15	128.79	1.42	0	1.42	77.52	2.37	0	5	0.76	0.8	2.22	83.06	0.06	34.84	7
23	94.4	4.91	1.21	-6.9	94.42	5.2	9	2.46	133	1.49	0	1.49	62.56	5.28	0	4	0.89	0.74	2.55	64.86	0.06	18.15	3
24	107.87	7	1.45	-7.1	107.89	6.48	9	2.5	135.92	1.55	0	1.55	68.45	6.58	0	9	0.92	0.7	2.6	70.7	0.07	15.08	3
25	95.76	3.34	2.91	-7.03	95.8	3.49	5	2.32	130.23	1.62	0	1.62	58.18	3.55	0	4	0.86	0.69	2.44	61.85	0.13	24.82	5
26	107.77	4.07	2.78	-7.29	107.8	3.78	5	2.32	131.96	1.68	0	1.68	62.99	3.84	0	4	0.86	0.67	2.44	67.24	0.12	23.54	5
27	63.7	3.97	3.38	-7.79	63.74	6.23	3	2.63	130.49	1.75	0	1.75	35.42	6.4	0	3	1	0.61	2.79	35.49	0.14	15.31	3
28	123.85	5.01	3.28	-8.38	123.89	4.05	9	2.3	133.82	1.82	0	1.82	67.19	4.11	0	4	0.87	0.63	2.44	72.23	0.13	22.43	5
29	107.14	5.64	3.45	-8.9	107.18	5.26	9	2.43	134.33	1.88	0	1.88	55.89	5.36	0	4	0.93	0.59	2.59	58.34	0.13	17.87	3
30	77.59	3.34	3.57	-9.49	77.63	4.3	4	2.45	129.71	1.95	0	1.95	38.84	4.42	0	4	0.95	0.56	2.64	40.1	0.13	20.28	3
31	129.8	3.34	3.97	-9.78	129.85	2.57	5	2.14	130.97	2.01	0	2.01	63.46	2.61	0	5	0.82	0.59	2.3	71.16	0.14	31.7	5
32	161.13	5.22	4.67	-9.88	161.19	3.24	8	2.16	134.76	2.08	0	2.08	76.43	3.28	0	5	0.83	0.57	2.32	85.63	0.16	27.24	5
33	182.02	5.64	5.18	-10.36	182.08	3.1	8	2.11	135.62	2.15	0	2.15	83.71	3.13	0	5	0.82	0.56	2.27	95.25	0.17	28.56	5
34	218.88	6.58	5.15	-11.09	218.94	3	8	2.05	137.2	2.22	0	2.22	97.71	3.04	0	5	0.8	0.55	2.21	113.44	0.17	29.79	5
35	148.29	6.06	5.07	-11.47	148.35	4.08	8	2.26	135.64	2.29	0	2.29	63.9	4.15	0	4	0.89	0.5	2.46	69.31	0.16	22.19	5
36	103.07	5.22	3.96	-10.56	103.12	5.06	9	2.43	133.67	2.35	0	2.35	42.83	5.18	0	4	0.98	0.46	2.66	43.66	0.12	18.11	3
37	186.92	0	4.83	-10.53	186.98	0	0	0	87.36	2.4	0	2.4	77.02	0	0	0	1	0.44	4.06	77.02	0.15	124.32	0

Presented below is a list of formulas used for the estimation of various soil properties. The formulas are presented in SI unit system and assume that all components are expressed in the same units.

:: Unit Weight, g (kN/m³) ::

$$g = g_w \cdot \left(0.27 \cdot \log(R_f) + 0.36 \cdot \log\left(\frac{q_t}{p_a}\right) + 1.236 \right)$$

where g_w = water unit weight

:: Permeability, k (m/s) ::

$$I_c < 3.27 \text{ and } I_c > 1.00 \text{ then } k = 10^{0.952-3.04 \cdot I_c}$$

$$I_c \leq 4.00 \text{ and } I_c > 3.27 \text{ then } k = 10^{-4.52-1.37 \cdot I_c}$$

:: N_{SPT} (blows per 30 cm) ::

$$N_{60} = \left(\frac{q_c}{p_a} \right) \cdot \frac{1}{10^{1.1268-0.2817 \cdot I_c}}$$

$$N_{I(60)} = Q_{tn} \cdot \frac{1}{10^{1.1268-0.2817 \cdot I_c}}$$

:: Young's Modulus, E_s (MPa) ::

$$(q_t - \sigma_v) \cdot 0.015 \cdot 10^{0.55 \cdot I_c + 1.68}$$

(applicable only to $I_c < I_{c_cutoff}$)

:: Relative Density, D_r (%) ::

$$100 \cdot \sqrt{\frac{Q_{tn}}{k_{DR}}} \quad \text{(applicable only to SBT}_n\text{: 5, 6, 7 and 8 or } I_c < I_{c_cutoff}\text{)}$$

:: State Parameter, ψ ::

$$\psi = 0.56 - 0.33 \cdot \log(Q_{tn,cs})$$

:: Peak drained friction angle, ϕ (°) ::

$$\phi = 17.60 + 11 \cdot \log(Q_{tn})$$

(applicable only to SBT_n: 5, 6, 7 and 8)

:: 1-D constrained modulus, M (MPa) ::

If $I_c > 2.20$

$$\alpha = 14 \text{ for } Q_{tn} > 14$$

$$\alpha = Q_{tn} \text{ for } Q_{tn} \leq 14$$

$$M_{CPT} = \alpha \cdot (q_t - \sigma_v)$$

If $I_c \leq 2.20$

$$M_{CPT} = (q_t - \sigma_v) \cdot 0.0188 \cdot 10^{0.55 \cdot I_c + 1.68}$$

:: Small strain shear Modulus, G_0 (MPa) ::

$$G_0 = (q_t - \sigma_v) \cdot 0.0188 \cdot 10^{0.55 \cdot I_c + 1.68}$$

:: Shear Wave Velocity, V_s (m/s) ::

$$V_s = \left(\frac{G_0}{\rho} \right)^{0.50}$$

:: Undrained peak shear strength, S_u (kPa) ::

$$N_{kt} = 10.50 + 7 \cdot \log(F_r) \text{ or user defined}$$

$$S_u = \frac{(q_t - \sigma_v)}{N_{kt}}$$

(applicable only to SBT_n: 1, 2, 3, 4 and 9 or $I_c > I_{c_cutoff}$)

:: Remolded undrained shear strength, $S_{u(rem)}$ (kPa) ::

$$S_{u(rem)} = f_s \quad \text{(applicable only to SBT}_n\text{: 1, 2, 3, 4 and 9 or } I_c > I_{c_cutoff}\text{)}$$

:: Overconsolidation Ratio, OCR ::

$$k_{OCR} = \left[\frac{Q_{tn}^{0.20}}{0.25 \cdot (10.50 + 7 \cdot \log(F_r))} \right]^{1.25} \text{ or user defined}$$

$$OCR = k_{OCR} \cdot Q_{tn}$$

(applicable only to SBT_n: 1, 2, 3, 4 and 9 or $I_c > I_{c_cutoff}$)

:: In situ Stress Ratio, K_0 ::

$$K_0 = (1 - \sin \phi') \cdot OCR^{\sin \phi'}$$

(applicable only to SBT_n: 1, 2, 3, 4 and 9 or $I_c > I_{c_cutoff}$)

:: Soil Sensitivity, S_t ::

$$S_t = \frac{N_s}{F_r}$$

(applicable only to SBT_n: 1, 2, 3, 4 and 9 or $I_c > I_{c_cutoff}$)

:: Effective Stress Friction Angle, ϕ' (°) ::

$$\phi' = 29.5^\circ \cdot B_q^{0.121} \cdot (0.256 + 0.336 \cdot B_q + \log Q_t)$$

(applicable for $0.10 < B_q < 1.00$)

References

- Robertson, P.K., Cabal K.L., Guide to Cone Penetration Testing for Geotechnical Engineering, Gregg Drilling & Testing, Inc., 5th Edition, November 2012
- Robertson, P.K., Interpretation of Cone Penetration Tests - a unified approach., Can. Geotech. J. 46(11): 1337–1355 (2009)

Appendix B

Laboratory Testing Program

APPENDIX B: LABORATORY TESTING PROGRAM

Tests were conducted in our laboratory on representative soil samples for the purpose of classification and evaluation of their relevant physical characteristics and engineering properties. The amount and selection of tests were based on the geotechnical requirements of the project. Test results are presented herein and on the Logs of Borings in Appendix A, *Field Exploration*. The following is a summary of the laboratory tests conducted for this project.

B.1 Moisture Content and Dry Density

Results of moisture content and dry density tests, performed on relatively undisturbed ring samples were used to aid in the classification of the soils and to provide quantitative measure of the *in situ* dry density. Data obtained from this test provides qualitative information on strength and compressibility characteristics of site soils. For test results, see the Logs of Borings in Appendix A, *Field Exploration*.

B.2 Grain-Size Analysis

To assist in classification of soils, mechanical grain-size analyses were performed on Two (2) selected samples. Testing was performed in general accordance with the ASTM Standard C136 test method. Grain-size curves are shown in Drawing No. B-1, *Grain Size Distribution Results*.

B.3 Atterberg Limits

Atterberg limits test were performed on three (2) representative samples to assist the classification of the soil and fill materials according to ASTM Standard D4318 test method. The test results are presented in the following table and on Drawing No. B 2, *Atterburg Limits Results*.

Table No. B-1 Atterberg Limit Test Results

Boring No.	Depth (feet)	Soil Classification	Liquid Limit (%)	Plastic Limit (%)	Plastic Index (%)
BH-2	35	Clay (CL)	36	23	13
BH-8	10	Clay (CL)	46	22	24

B.4 Percent Finer than Sieve No. 200

The percent finer than sieve No. 200 tests were performed on three (3) representative soil samples to aid in the classification of the on-site soils and to estimate other engineering parameters. Testing was performed in general accordance with the ASTM

Standard D1140 test method. Test results are presented in the Logs of Borings in Appendix A, *Field Exploration*.

Table No. B-2, Percent Passing Sieve # 200 Results

Boring No.	Depth (feet)	Soil Classification	Percent Passing Sieve No. 200
BH-11	15	Silty Sand (SM)	36%
BH-11	25	Silty Sand (SM)	29%
BH-11	35	Silt (ML)	71%

B.5 Maximum Dry Density Test

One (1) laboratory maximum dry density-moisture content relationship test was performed on one representative bulk sample. The test was conducted in accordance with ASTM Standard D1557 laboratory procedure. The test result is presented on Drawing No. B-3, *Moisture-Density Relationship Results*.

B.6 Direct Shear

Direct shear tests were performed on two (2) relatively undisturbed samples at soaked moisture conditions. For each test, three samples contained in brass sampler rings were placed, one at a time, directly into the test apparatus and subjected to a range of normal loads appropriate for the anticipated conditions. The samples were then sheared at a constant strain rate of 0.01 inch/minute. Shear deformation was recorded until a maximum of about 0.50-inch shear displacement was achieved. Ultimate strength was selected from the shear-stress deformation data and plotted to determine the shear strength parameters. For test data, including sample density and moisture content, see Drawing Nos. B-4 through B-5, *Direct Shear Test Results*, and in the following table:

Table No. B-3, Direct Shear Test Results

Boring No.	Depth (feet)	Soil Classification	Peak Strength Parameters	
			Friction Angle (degrees)	Cohesion (psf)
BH-2	40	Silt Stone	29	480
BH-7	10	Silty Clay (CL)	31	150

B.7 Consolidation Test

Consolidation tests were performed on two (2) selected samples. Data obtained from this test performed on a relatively undisturbed soil sample was used to evaluate the settlement characteristics of the foundation soils under load. Preparation for this test involved trimming the sample and placing the one-inch high brass ring into the test apparatus, which contained porous stones, both top and bottom, to accommodate drainage during testing. Normal axial loads were applied to one end of the sample

through the porous stones, and the resulting deflections were recorded at various time periods. The load was increased after the sample reached a reasonable state of equilibrium. Normal loads were applied at a constant load-increment ratio, successive loads being generally twice the preceding load. The sample was tested at field and submerged conditions. The test results, including sample density and moisture content, are presented in Drawing Nos. B-6 through B-7, *Consolidation Test Results*.

B.8 R-Value Test

One (1) representative bulk soil sample was tested for resistance value (R-value) in accordance with ASTM D2844 Standard. This test is designed to provide a relative measure of soil strength for use in pavement design. The test results are shown in the following table:

Table No. B-4, R-value Test Result

Boring No.	Depth (feet)	Soil Classification	Measured R-value
BH-8	1-5	Silty Clay (CL)	13

B.9 Soil Corrosivity

Two (2) representative soil samples were tested to determine minimum electrical resistivity, pH, and chemical content, including chloride concentrations, and soluble sulfate. The purpose of these tests is to determine the corrosion potential of site soils when placed in contact with common construction materials. These tests were performed by EGL in Arcadia, California. The test results received from EGL are included in the following table:

Table No. B-5, Corrosivity Test Results

Boring No.	Sample Depth (feet)	pH (Caltrans 643)	Soluble Chlorides (Caltrans 422) ppm	Soluble Sulfate (Caltrans 417) (%)	Saturated Resistivity (Caltrans 532) Ohm-cm
BH-1	35	7.62	170	0.071	480
BH-10	10	7.78	190	0.095	570

B.10 Sand Equivalent Test

One (1) representative sample was tested to quantify the relative abundance of sand versus clay in material encountered at the site. The tests were conducted in accordance with ASTM Standard D 2419 laboratory procedure. The test results are presented in the table below.

Table No. B-6, Sand Equivalent Test Results

Boring No.	Depth (feet)	Soil Classification	Average Sand Equivalent
BH-7	5	Clay (CL)	5

B.11 Sample Storage

Soil samples presently stored in our laboratory will be discarded 30 days after the date of this report, unless this office receives a specific request to retain the samples for a longer period of time.

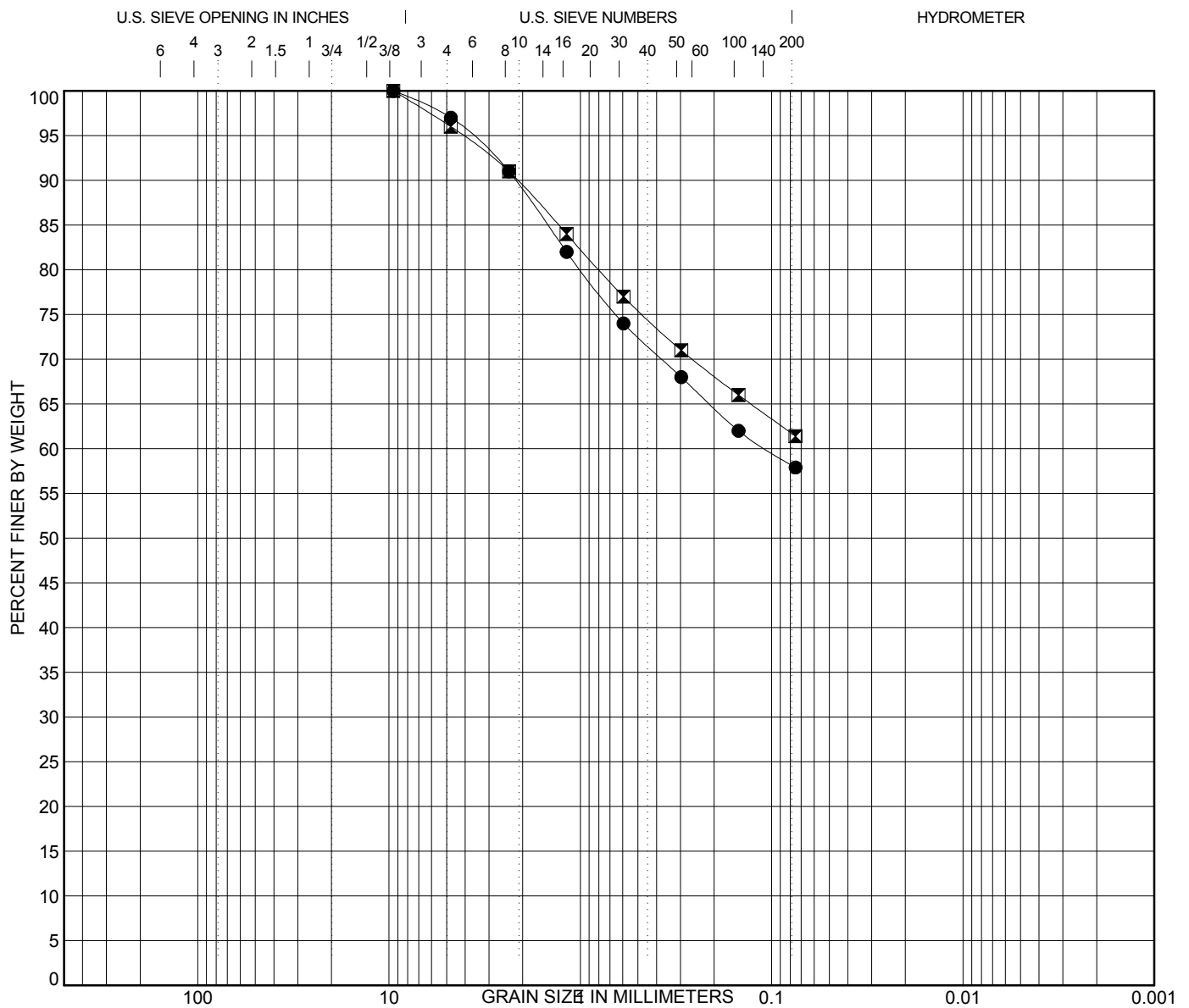

COBBLES	GRAVEL		SAND			SILT OR CLAY
	coarse	fine	coarse	medium	fine	

Boring No.	Depth (ft)	Description					LL	PL	PI	Cc	Cu
● BH-6	0-5	SILTY CLAY (CL)									
☒ BH-11	0	SILTY CLAY (CL)									
Boring No.	Depth (ft)	D100	D60	D30	D10	%Gravel	%Sand	%Silt	%Clay		
● BH-6	0-5	9.5	0.107			3.0	39.1	57.9			
☒ BH-11	0	9.5				4.0	34.6	61.4			

GRAIN SIZE DISTRIBUTION RESULTS



Converse Consultants

Project Name
 MT. SAN ANTONIO COLLEGE
 LOT R PARKING STRUCTURE
 WALNUT, CALIFORNIA

Project No.
 17-31-247-01

Figure No.
 B-1

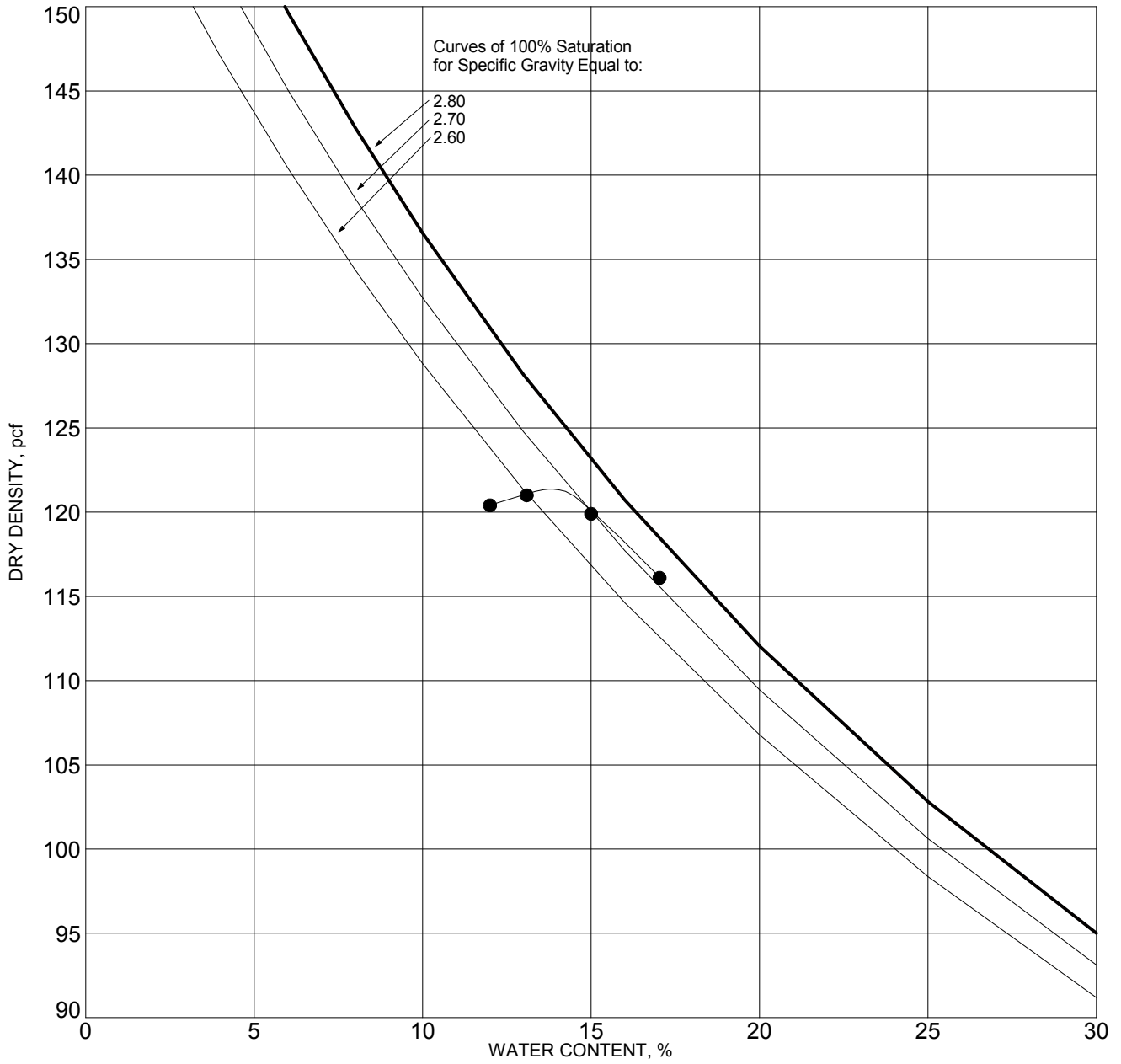

SYMBOL	BORING NO.	DEPTH (ft)	DESCRIPTION	ASTM TEST METHOD	OPTIMUM WATER, %	MAXIMUM DRY DENSITY, pcf
●	BH- 6	0	SILTY CLAY (CL)	D1557 Method B	14	122

NOTE:

MOISTURE-DENSITY RELATIONSHIP RESULTS



Converse Consultants

Project Name
 MT. SAN ANTONIO COLLEGE
 PARKING LOT R
 WALNUT, CALIFORNIA

Project No.
 17-31-247-01

Figure No.
 B-3

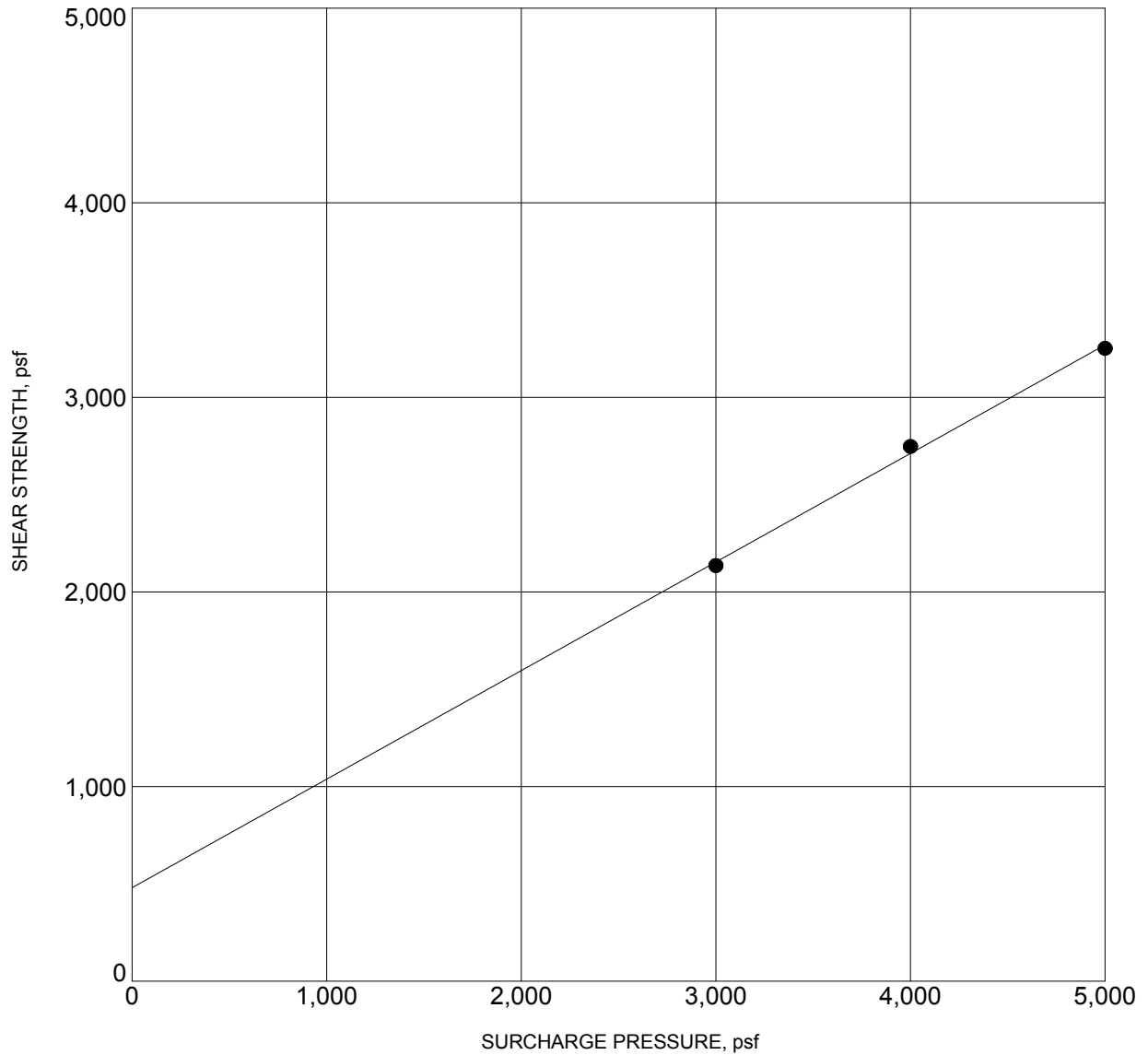

BORING NO. :	BH- 2	DEPTH (ft) :	40
DESCRIPTION :	BEDROCK: SILTSTONE		
COHESION (psf) :	480	FRICTION ANGLE (degrees):	29
MOISTURE CONTENT (%) :	12.0	DRY DENSITY (pcf) :	114.3

NOTE: Ultimate Strength.

DIRECT SHEAR TEST RESULTS



Converse Consultants

Project Name
 MT. SAN ANTONIO COLLEGE
 LOT R PARKING STRUCTURE
 WALNUT, CALIFORNIA

Project No.
 17-31-247-01

Figure No.
 B-4

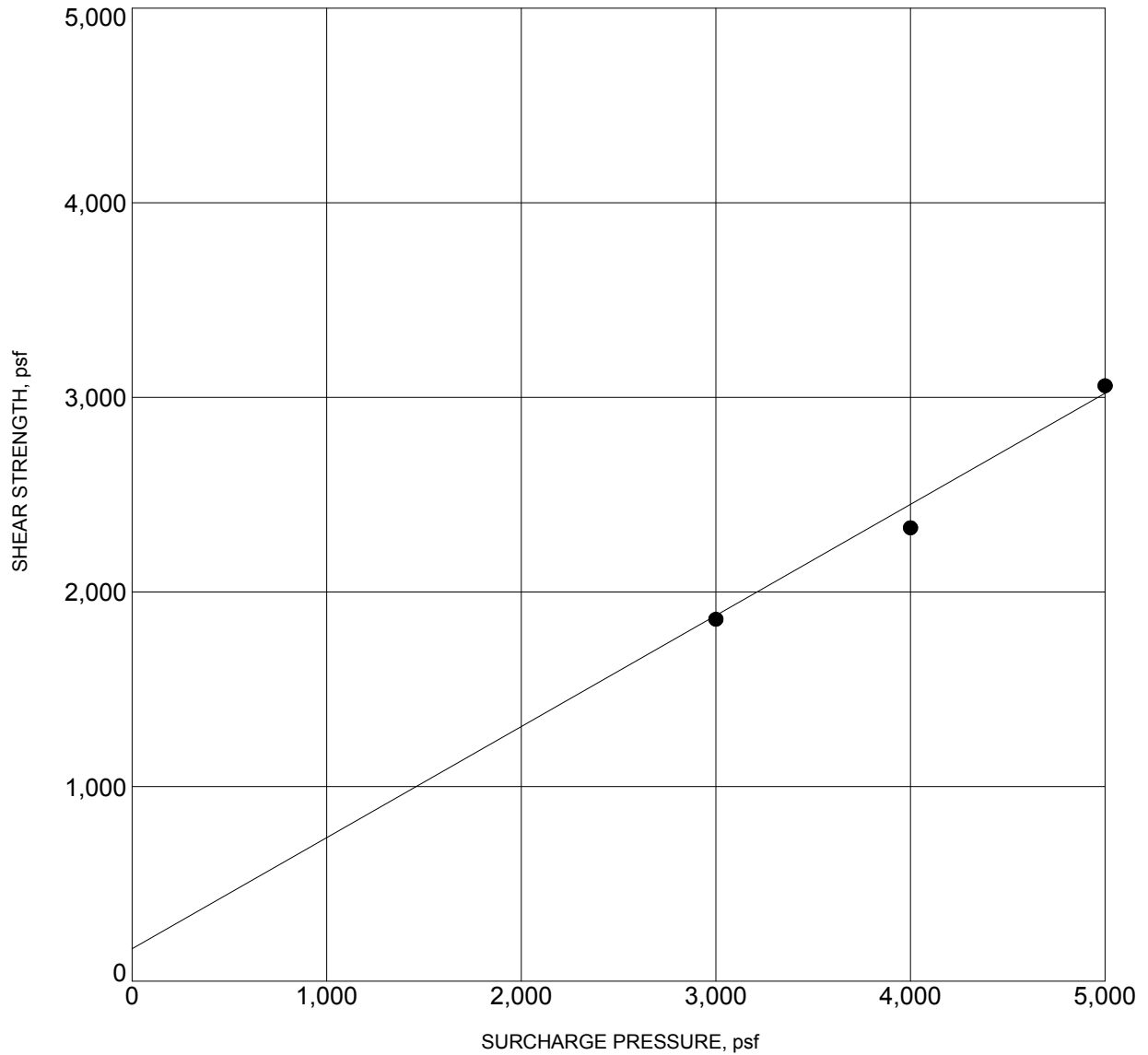

BORING NO. :	BH- 7	DEPTH (ft) :	10
DESCRIPTION :	SILTY CLAY (CL)		
COHESION (psf) :	150	FRICTION ANGLE (degrees):	31
MOISTURE CONTENT (%) :	19.0	DRY DENSITY (pcf) :	96.0

NOTE: Ultimate Strength.

DIRECT SHEAR TEST RESULTS



Converse Consultants

Project Name
 MT. SAN ANTONIO COLLEGE
 LOT R PARKING STRUCTURE
 WALNUT, CALIFORNIA

Project No.
 17-31-247-01

Figure No.
 B-5

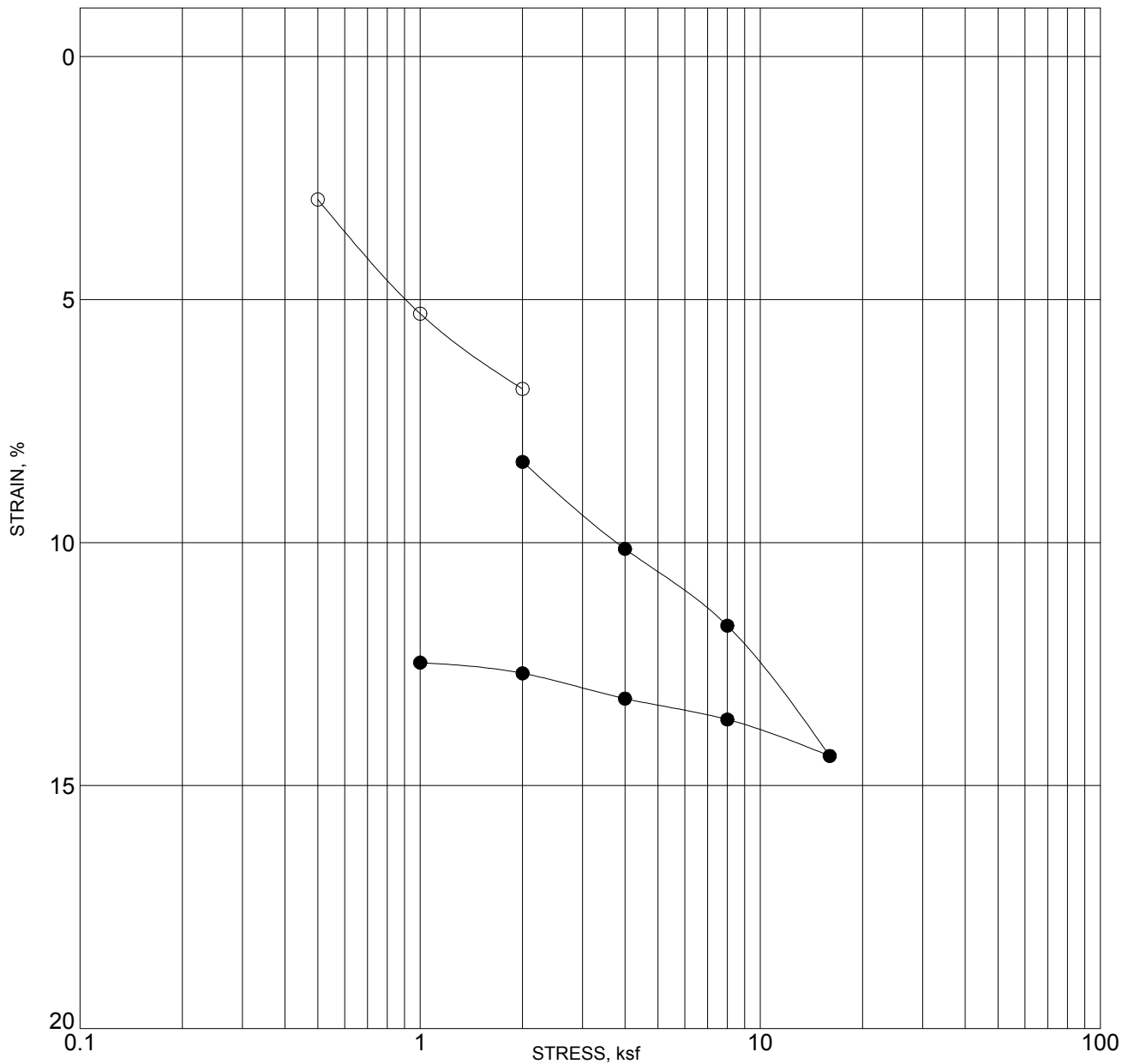

BORING NO. :		BH- 3		DEPTH (ft) :		40	
DESCRIPTION :				BEDROCK: SILTSTONE AND SANDSTONE			
MOISTURE CONTENT (%)		DRY DENSITY (pcf)		PERCENT SATURATION		VOID RATIO	
INITIAL	12	108.83		62		0.471	
FINAL							

NOTE: SOLID CIRCLES INDICATE READINGS AFTER ADDITION OF WATER

CONSOLIDATION TEST RESULTS



Converse Consultants

Project Name
 MT. SAN ANTONIO COLLEGE
 LOT R PARKING STRUCTURE
 WALNUT, CALIFORNIA

Project No.
 17-31-247-01

Figure No.
 B-6

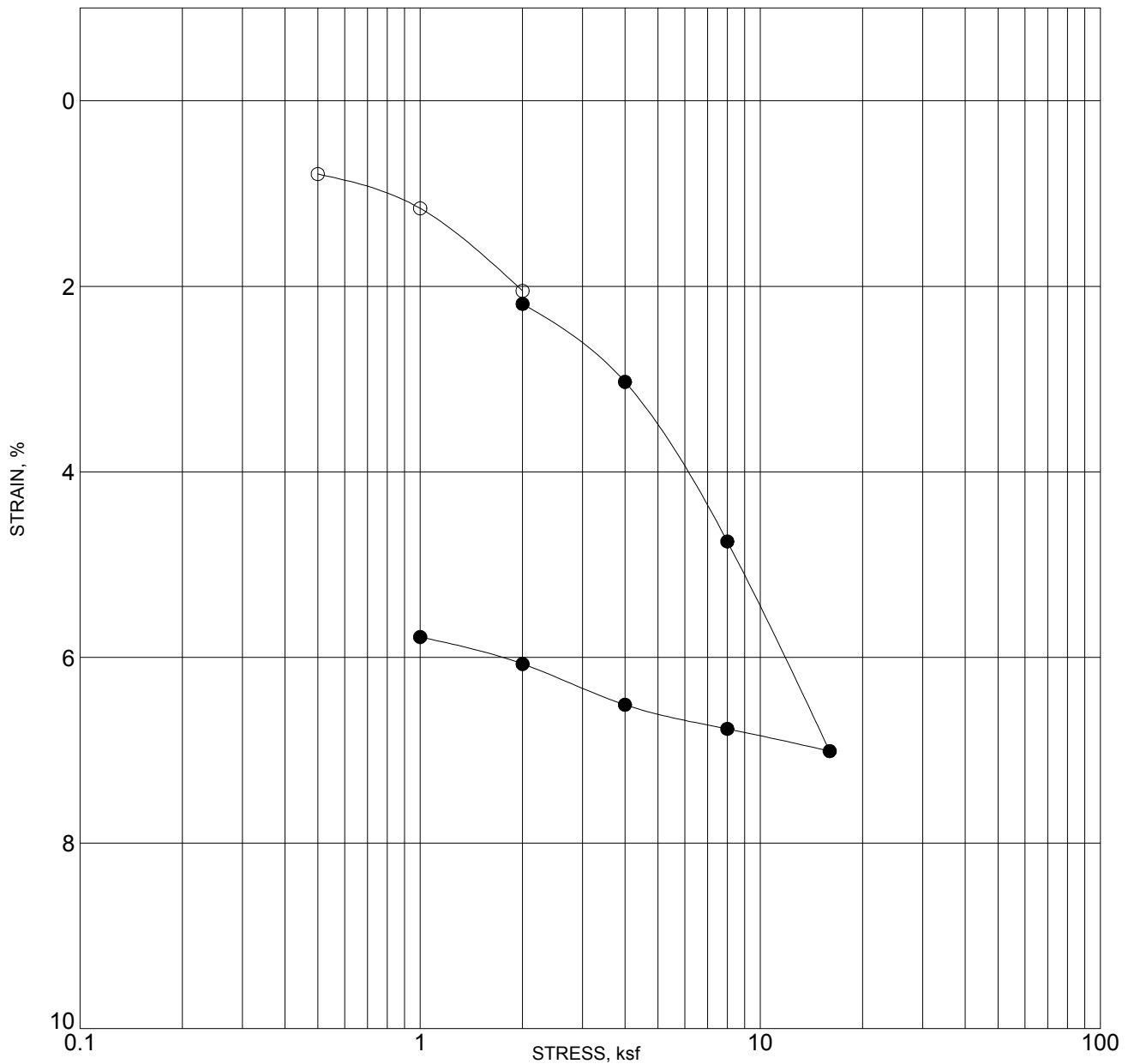

BORING NO. :		BH- 5		DEPTH (ft) :		10	
DESCRIPTION :		SANDY SILT (ML)					
MOISTURE CONTENT (%)		DRY DENSITY (pcf)		PERCENT SATURATION		VOID RATIO	
INITIAL	6	106.43		29		0.537	
FINAL							

NOTE: SOLID CIRCLES INDICATE READINGS AFTER ADDITION OF WATER

CONSOLIDATION TEST RESULTS



Converse Consultants

Project Name
 MT. SAN ANTONIO COLLEGE
 LOT R PARKING STRUCTURE
 WALNUT, CALIFORNIA

Project No.
 17-31-247-01

Figure No.
 B-7

Appendix C

Liquefaction/Seismic Settlement Analysis

APPENDIX C: LIQUEFACTION/SEISMIC SETTLEMENT ANALYSIS

Liquefaction is defined as the phenomenon where a soil mass exhibits a substantial reduction in its shear strength. This strength reduction is due to the development of excess pore pressure in a soil mass caused by earthquake induced ground motions. Saturated soils behave temporarily as a viscous fluid (liquefaction) and, consequently, lose their capacity to support the structures founded on them. The potential for liquefaction decreases with increasing clay and gravel content, but increases as the ground acceleration and duration of shaking increase. Liquefaction potential has been found to be the greatest where the groundwater level and loose sands occur within 50 feet of the ground surface.

Our liquefaction analyses are based on the *Special Publication 117A: Guidelines for Evaluating and Mitigating Seismic Hazards in California (9/2008)*, *Recommended Procedures for Implementation of DMG Special Publication 117, Guidelines for Analyzing and Mitigating Liquefaction Hazards in California (3/1999)*, and *2013 California Building Code*.

The subsurface data obtained from exploratory borings were used to evaluate the liquefaction/seismic settlement potential of the area. The Log of Borings is presented in Appendix A, *Field Exploration*. The liquefaction potential and seismic settlement analyses were performed utilizing data obtained from BH-4, BH-6, CPT-9 and BH-11 for the upper 50 feet of soil. The analyses were performed using *LiquefyPro*, Version 5.8d, 2009, by Civil Tech Software utilizing BH-4, BH-6, CPT-9 and BH-11. Based on the results of liquefaction analyses indicate the project site is susceptible to liquefaction. The following seismic parameters are used for liquefaction potential analyses.

Table No. C-1, Seismic Parameters Used in Liquefaction Analysis

Groundwater Depth* (feet)	Earthquake Magnitude** (Mw)	Peak Ground Acceleration*** (g)
23	6.89	0.776

* Based on research of Los Angeles County Groundwater Wells No. 3145, No. 3155 and No. 3155A

** Based on the 2008 NSHMP PSHA Interactive Deaggregation web site for a return period of 2475 years

***Based on $S_{Ds}/2.5$ per CBC 2013

The estimated potential liquefaction-induced settlement ranges from 0.43 to 2.58 inches with potential differential settlement ranging from 0.22 to 1.29 inches. The project structural engineer should consider the effects of seismically-induced settlement in the foundation design.

LIQUEFACTION ANALYSIS

17-31-247-01

Hole No.=4 Water Depth=22 ft

Magnitude=6.89
Acceleration=0.776g

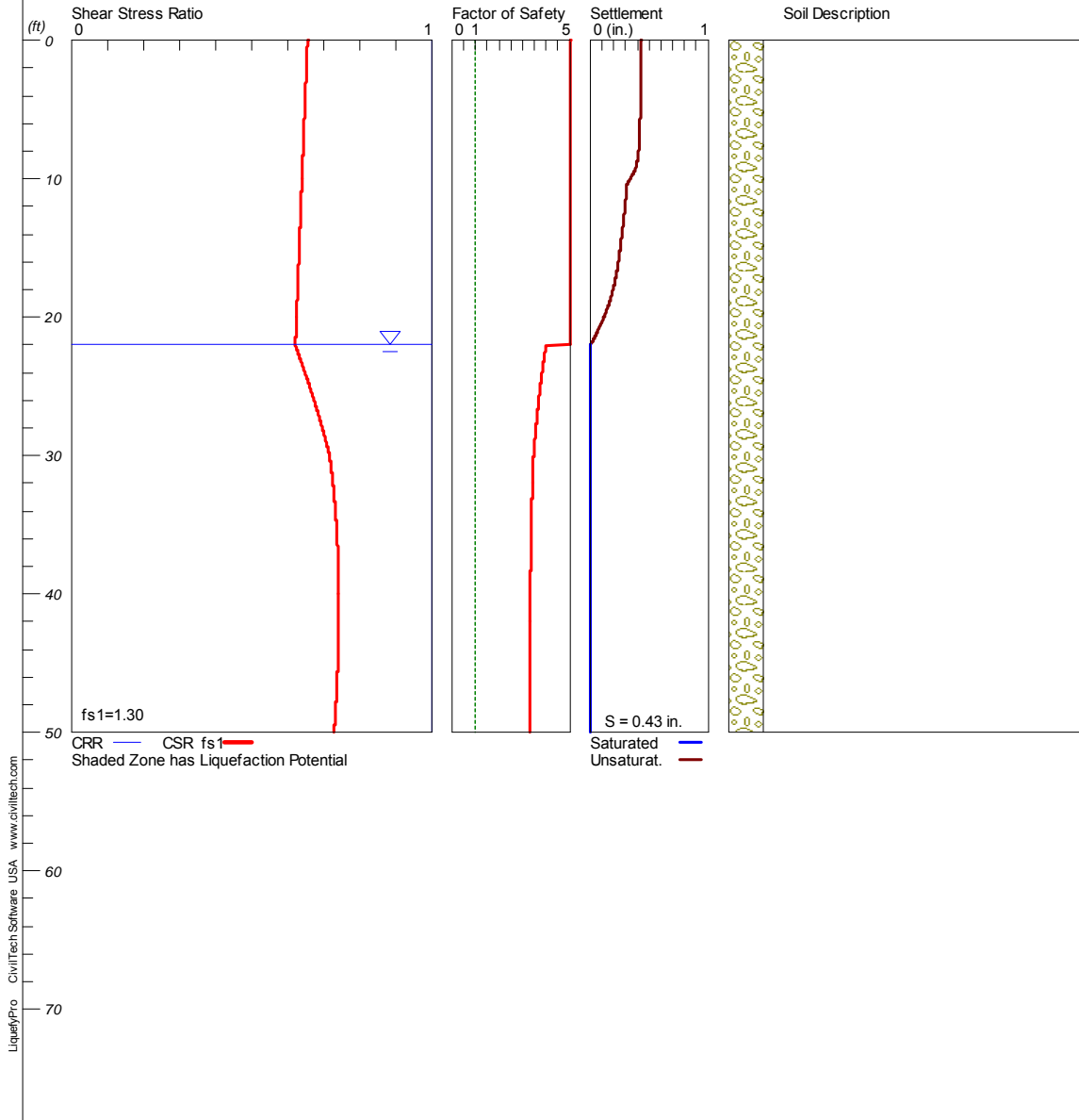

 LIQUEFACTION ANALYSIS SUMMARY
 Copyright by CivilTech Software
 www.civiltechsoftware.com

Font: Courier New, Regular, Size 8 is recommended for this report.
 Licensed to , 10/27/2017 9:11:04 AM

Input File Name: K:\Ram\17-31-247-00 MT SAC lot R&S\Parking Lot R\Liquefaction Analysis\BH4.liq
 Title: 17-31-247-01
 Subtitle: Parking Lor R Mt sac

Surface Elev.=
 Hole No.=4
 Depth of Hole= 50.00 ft
 Water Table during Earthquake= 22.00 ft
 Water Table during In-Situ Testing= 25.00 ft
 Max. Acceleration= 0.78 g
 Earthquake Magnitude= 6.89

Input Data:

Surface Elev.=
 Hole No.=4
 Depth of Hole=50.00 ft
 Water Table during Earthquake= 22.00 ft
 Water Table during In-Situ Testing= 25.00 ft
 Max. Acceleration=0.78 g
 Earthquake Magnitude=6.89
 No-Liquefiable Soils: CL, OL are Non-Liq. Soil

1. SPT or BPT Calculation.
 2. Settlement Analysis Method: Ishihara / Yoshimine
 3. Fines Correction for Liquefaction: Modify Stark/Olson
 4. Fine Correction for Settlement: During Liquefaction*
 5. Settlement Calculation in: All zones*
 6. Hammer Energy Ratio, Ce = 1.25
 7. Borehole Diameter, Cb= 1
 8. Sampling Method, Cs= 1
 9. User request factor of safety (apply to CSR) , User= 1.3
 Plot one CSR curve (fs1=User)
 10. Use Curve Smoothing: Yes*
- * Recommended Options

In-Situ Test Data:

Depth ft	SPT	gamma pcf	Fines %
0.00	50.00	110.00	61.00
5.00	50.00	110.00	61.00
10.00	29.40	110.00	55.00
15.00	48.00	110.00	36.00
20.00	38.50	110.00	32.00
25.00	50.00	110.00	29.00
30.00	49.00	115.00	50.00
35.00	50.00	115.00	71.00
40.00	49.00	115.00	71.00
45.00	50.00	115.00	71.00
50.00	50.00	115.00	71.00

Output Results:

Settlement of Saturated Sands=0.00 in.
 Settlement of Unsaturated Sands=0.43 in.
 Total Settlement of Saturated and Unsaturated Sands=0.43 in.
 Differential Settlement=0.217 to 0.287 in.

Depth ft	CRRm	CSRfs	F.S.	S_sat in.	S_dry in.	S_all in.
0.00	2.48	0.66	5.00	0.00	0.43	0.43
0.05	2.48	0.66	5.00	0.00	0.43	0.43
0.10	2.48	0.66	5.00	0.00	0.43	0.43
0.15	2.48	0.66	5.00	0.00	0.43	0.43
0.20	2.48	0.66	5.00	0.00	0.43	0.43
0.25	2.48	0.66	5.00	0.00	0.43	0.43
0.30	2.48	0.66	5.00	0.00	0.43	0.43
0.35	2.48	0.66	5.00	0.00	0.43	0.43
0.40	2.48	0.66	5.00	0.00	0.43	0.43
0.45	2.48	0.66	5.00	0.00	0.43	0.43
0.50	2.48	0.65	5.00	0.00	0.43	0.43
0.55	2.48	0.65	5.00	0.00	0.43	0.43
0.60	2.48	0.65	5.00	0.00	0.43	0.43
0.65	2.48	0.65	5.00	0.00	0.43	0.43
0.70	2.48	0.65	5.00	0.00	0.43	0.43
0.75	2.48	0.65	5.00	0.00	0.43	0.43
0.80	2.48	0.65	5.00	0.00	0.43	0.43
0.85	2.48	0.65	5.00	0.00	0.43	0.43
0.90	2.48	0.65	5.00	0.00	0.43	0.43
0.95	2.48	0.65	5.00	0.00	0.43	0.43
1.00	2.48	0.65	5.00	0.00	0.43	0.43

19.05	2.48	0.63	5.00	0.00	0.16	0.16
19.10	2.48	0.63	5.00	0.00	0.16	0.16
19.15	2.48	0.63	5.00	0.00	0.15	0.15
19.20	2.48	0.63	5.00	0.00	0.15	0.15
19.25	2.48	0.63	5.00	0.00	0.15	0.15
19.30	2.48	0.63	5.00	0.00	0.15	0.15
19.35	2.48	0.63	5.00	0.00	0.14	0.14
19.40	2.48	0.63	5.00	0.00	0.14	0.14
19.45	2.48	0.63	5.00	0.00	0.14	0.14
19.50	2.48	0.63	5.00	0.00	0.14	0.14
19.55	2.48	0.63	5.00	0.00	0.14	0.14
19.60	2.48	0.63	5.00	0.00	0.13	0.13
19.65	2.48	0.63	5.00	0.00	0.13	0.13
19.70	2.48	0.63	5.00	0.00	0.13	0.13
19.75	2.48	0.63	5.00	0.00	0.13	0.13
19.80	2.48	0.63	5.00	0.00	0.12	0.12
19.85	2.48	0.63	5.00	0.00	0.12	0.12
19.90	2.48	0.63	5.00	0.00	0.12	0.12
19.95	2.48	0.63	5.00	0.00	0.12	0.12
20.00	2.48	0.63	5.00	0.00	0.11	0.11
20.05	2.48	0.63	5.00	0.00	0.11	0.11
20.10	2.48	0.62	5.00	0.00	0.11	0.11
20.15	2.48	0.62	5.00	0.00	0.11	0.11
20.20	2.48	0.62	5.00	0.00	0.10	0.10
20.25	2.48	0.62	5.00	0.00	0.10	0.10
20.30	2.48	0.62	5.00	0.00	0.10	0.10
20.35	2.48	0.62	5.00	0.00	0.10	0.10
20.40	2.48	0.62	5.00	0.00	0.09	0.09
20.45	2.48	0.62	5.00	0.00	0.09	0.09
20.50	2.48	0.62	5.00	0.00	0.09	0.09
20.55	2.48	0.62	5.00	0.00	0.09	0.09
20.60	2.48	0.62	5.00	0.00	0.08	0.08
20.65	2.48	0.62	5.00	0.00	0.08	0.08
20.70	2.48	0.62	5.00	0.00	0.08	0.08
20.75	2.48	0.62	5.00	0.00	0.07	0.07
20.80	2.48	0.62	5.00	0.00	0.07	0.07
20.85	2.48	0.62	5.00	0.00	0.07	0.07
20.90	2.48	0.62	5.00	0.00	0.07	0.07
20.95	2.48	0.62	5.00	0.00	0.06	0.06
21.00	2.48	0.62	5.00	0.00	0.06	0.06
21.05	2.48	0.62	5.00	0.00	0.06	0.06
21.10	2.48	0.62	5.00	0.00	0.06	0.06
21.15	2.48	0.62	5.00	0.00	0.05	0.05
21.20	2.48	0.62	5.00	0.00	0.05	0.05
21.25	2.48	0.62	5.00	0.00	0.05	0.05
21.30	2.48	0.62	5.00	0.00	0.04	0.04
21.35	2.48	0.62	5.00	0.00	0.04	0.04
21.40	2.48	0.62	5.00	0.00	0.04	0.04
21.45	2.48	0.62	5.00	0.00	0.04	0.04
21.50	2.48	0.62	5.00	0.00	0.03	0.03
21.55	2.48	0.62	5.00	0.00	0.03	0.03
21.60	2.48	0.62	5.00	0.00	0.03	0.03
21.65	2.48	0.62	5.00	0.00	0.02	0.02
21.70	2.48	0.62	5.00	0.00	0.02	0.02
21.75	2.48	0.62	5.00	0.00	0.02	0.02
21.80	2.48	0.62	5.00	0.00	0.02	0.02
21.85	2.48	0.62	5.00	0.00	0.01	0.01
21.90	2.48	0.62	5.00	0.00	0.01	0.01
21.95	2.48	0.62	5.00	0.00	0.01	0.01
22.00	2.48	0.62	5.00	0.00	0.00	0.00
22.05	2.48	0.62	3.99	0.00	0.00	0.00
22.10	2.48	0.62	3.99	0.00	0.00	0.00
22.15	2.48	0.62	3.98	0.00	0.00	0.00
22.20	2.48	0.62	3.98	0.00	0.00	0.00
22.25	2.48	0.62	3.98	0.00	0.00	0.00
22.30	2.48	0.63	3.97	0.00	0.00	0.00
22.35	2.48	0.63	3.97	0.00	0.00	0.00
22.40	2.48	0.63	3.96	0.00	0.00	0.00
22.45	2.48	0.63	3.96	0.00	0.00	0.00
22.50	2.48	0.63	3.95	0.00	0.00	0.00
22.55	2.48	0.63	3.95	0.00	0.00	0.00
22.60	2.48	0.63	3.94	0.00	0.00	0.00
22.65	2.48	0.63	3.94	0.00	0.00	0.00
22.70	2.48	0.63	3.94	0.00	0.00	0.00
22.75	2.48	0.63	3.93	0.00	0.00	0.00
22.80	2.48	0.63	3.93	0.00	0.00	0.00
22.85	2.48	0.63	3.92	0.00	0.00	0.00
22.90	2.48	0.63	3.92	0.00	0.00	0.00
22.95	2.48	0.63	3.91	0.00	0.00	0.00
23.00	2.48	0.64	3.91	0.00	0.00	0.00
23.05	2.48	0.64	3.91	0.00	0.00	0.00
23.10	2.48	0.64	3.90	0.00	0.00	0.00
23.15	2.48	0.64	3.90	0.00	0.00	0.00
23.20	2.48	0.64	3.89	0.00	0.00	0.00
23.25	2.48	0.64	3.89	0.00	0.00	0.00
23.30	2.48	0.64	3.88	0.00	0.00	0.00
23.35	2.48	0.64	3.88	0.00	0.00	0.00
23.40	2.48	0.64	3.88	0.00	0.00	0.00
23.45	2.48	0.64	3.87	0.00	0.00	0.00
23.50	2.48	0.64	3.87	0.00	0.00	0.00

23.55	2.48	0.64	3.86	0.00	0.00	0.00
23.60	2.48	0.64	3.86	0.00	0.00	0.00
23.65	2.48	0.64	3.86	0.00	0.00	0.00
23.70	2.48	0.64	3.85	0.00	0.00	0.00
23.75	2.48	0.65	3.85	0.00	0.00	0.00
23.80	2.48	0.65	3.84	0.00	0.00	0.00
23.85	2.48	0.65	3.84	0.00	0.00	0.00
23.90	2.48	0.65	3.84	0.00	0.00	0.00
23.95	2.48	0.65	3.83	0.00	0.00	0.00
24.00	2.48	0.65	3.83	0.00	0.00	0.00
24.05	2.48	0.65	3.82	0.00	0.00	0.00
24.10	2.48	0.65	3.82	0.00	0.00	0.00
24.15	2.48	0.65	3.82	0.00	0.00	0.00
24.20	2.48	0.65	3.81	0.00	0.00	0.00
24.25	2.48	0.65	3.81	0.00	0.00	0.00
24.30	2.48	0.65	3.81	0.00	0.00	0.00
24.35	2.48	0.65	3.80	0.00	0.00	0.00
24.40	2.48	0.65	3.80	0.00	0.00	0.00
24.45	2.48	0.65	3.79	0.00	0.00	0.00
24.50	2.48	0.66	3.79	0.00	0.00	0.00
24.55	2.48	0.66	3.79	0.00	0.00	0.00
24.60	2.48	0.66	3.78	0.00	0.00	0.00
24.65	2.48	0.66	3.78	0.00	0.00	0.00
24.70	2.48	0.66	3.78	0.00	0.00	0.00
24.75	2.48	0.66	3.77	0.00	0.00	0.00
24.80	2.48	0.66	3.77	0.00	0.00	0.00
24.85	2.48	0.66	3.76	0.00	0.00	0.00
24.90	2.48	0.66	3.76	0.00	0.00	0.00
24.95	2.48	0.66	3.76	0.00	0.00	0.00
25.00	2.48	0.66	3.75	0.00	0.00	0.00
25.05	2.48	0.66	3.75	0.00	0.00	0.00
25.10	2.48	0.66	3.75	0.00	0.00	0.00
25.15	2.48	0.66	3.74	0.00	0.00	0.00
25.20	2.48	0.66	3.74	0.00	0.00	0.00
25.25	2.48	0.66	3.74	0.00	0.00	0.00
25.30	2.48	0.67	3.73	0.00	0.00	0.00
25.35	2.48	0.67	3.73	0.00	0.00	0.00
25.40	2.48	0.67	3.73	0.00	0.00	0.00
25.45	2.48	0.67	3.72	0.00	0.00	0.00
25.50	2.48	0.67	3.72	0.00	0.00	0.00
25.55	2.48	0.67	3.72	0.00	0.00	0.00
25.60	2.48	0.67	3.71	0.00	0.00	0.00
25.65	2.48	0.67	3.71	0.00	0.00	0.00
25.70	2.48	0.67	3.71	0.00	0.00	0.00
25.75	2.48	0.67	3.70	0.00	0.00	0.00
25.80	2.48	0.67	3.70	0.00	0.00	0.00
25.85	2.48	0.67	3.70	0.00	0.00	0.00
25.90	2.48	0.67	3.69	0.00	0.00	0.00
25.95	2.48	0.67	3.69	0.00	0.00	0.00
26.00	2.48	0.67	3.69	0.00	0.00	0.00
26.05	2.48	0.67	3.68	0.00	0.00	0.00
26.10	2.48	0.68	3.68	0.00	0.00	0.00
26.15	2.48	0.68	3.68	0.00	0.00	0.00
26.20	2.48	0.68	3.67	0.00	0.00	0.00
26.25	2.48	0.68	3.67	0.00	0.00	0.00
26.30	2.48	0.68	3.67	0.00	0.00	0.00
26.35	2.48	0.68	3.66	0.00	0.00	0.00
26.40	2.48	0.68	3.66	0.00	0.00	0.00
26.45	2.48	0.68	3.66	0.00	0.00	0.00
26.50	2.48	0.68	3.65	0.00	0.00	0.00
26.55	2.48	0.68	3.65	0.00	0.00	0.00
26.60	2.48	0.68	3.65	0.00	0.00	0.00
26.65	2.48	0.68	3.64	0.00	0.00	0.00
26.70	2.48	0.68	3.64	0.00	0.00	0.00
26.75	2.48	0.68	3.64	0.00	0.00	0.00
26.80	2.48	0.68	3.63	0.00	0.00	0.00
26.85	2.48	0.68	3.63	0.00	0.00	0.00
26.90	2.48	0.68	3.63	0.00	0.00	0.00
26.95	2.48	0.69	3.63	0.00	0.00	0.00
27.00	2.48	0.69	3.62	0.00	0.00	0.00
27.05	2.48	0.69	3.62	0.00	0.00	0.00
27.10	2.48	0.69	3.62	0.00	0.00	0.00
27.15	2.48	0.69	3.61	0.00	0.00	0.00
27.20	2.48	0.69	3.61	0.00	0.00	0.00
27.25	2.48	0.69	3.61	0.00	0.00	0.00
27.30	2.48	0.69	3.61	0.00	0.00	0.00
27.35	2.48	0.69	3.60	0.00	0.00	0.00
27.40	2.48	0.69	3.60	0.00	0.00	0.00
27.45	2.48	0.69	3.60	0.00	0.00	0.00
27.50	2.48	0.69	3.59	0.00	0.00	0.00
27.55	2.48	0.69	3.59	0.00	0.00	0.00
27.60	2.48	0.69	3.59	0.00	0.00	0.00
27.65	2.48	0.69	3.58	0.00	0.00	0.00
27.70	2.48	0.69	3.58	0.00	0.00	0.00
27.75	2.48	0.69	3.58	0.00	0.00	0.00
27.80	2.48	0.69	3.58	0.00	0.00	0.00
27.85	2.48	0.70	3.57	0.00	0.00	0.00
27.90	2.48	0.70	3.57	0.00	0.00	0.00
27.95	2.48	0.70	3.57	0.00	0.00	0.00
28.00	2.48	0.70	3.57	0.00	0.00	0.00

46.05	2.43	0.74	3.29	0.00	0.00	0.00
46.10	2.43	0.74	3.29	0.00	0.00	0.00
46.15	2.43	0.74	3.29	0.00	0.00	0.00
46.20	2.43	0.74	3.29	0.00	0.00	0.00
46.25	2.43	0.74	3.29	0.00	0.00	0.00
46.30	2.43	0.74	3.29	0.00	0.00	0.00
46.35	2.43	0.74	3.29	0.00	0.00	0.00
46.40	2.43	0.74	3.29	0.00	0.00	0.00
46.45	2.43	0.74	3.29	0.00	0.00	0.00
46.50	2.43	0.74	3.29	0.00	0.00	0.00
46.55	2.43	0.74	3.29	0.00	0.00	0.00
46.60	2.43	0.74	3.29	0.00	0.00	0.00
46.65	2.43	0.74	3.29	0.00	0.00	0.00
46.70	2.43	0.74	3.29	0.00	0.00	0.00
46.75	2.43	0.74	3.29	0.00	0.00	0.00
46.80	2.43	0.74	3.29	0.00	0.00	0.00
46.85	2.42	0.74	3.29	0.00	0.00	0.00
46.90	2.42	0.74	3.29	0.00	0.00	0.00
46.95	2.42	0.74	3.29	0.00	0.00	0.00
47.00	2.42	0.74	3.29	0.00	0.00	0.00
47.05	2.42	0.74	3.29	0.00	0.00	0.00
47.10	2.42	0.74	3.29	0.00	0.00	0.00
47.15	2.42	0.74	3.29	0.00	0.00	0.00
47.20	2.42	0.74	3.29	0.00	0.00	0.00
47.25	2.42	0.74	3.29	0.00	0.00	0.00
47.30	2.42	0.74	3.29	0.00	0.00	0.00
47.35	2.42	0.74	3.29	0.00	0.00	0.00
47.40	2.42	0.74	3.29	0.00	0.00	0.00
47.45	2.42	0.74	3.29	0.00	0.00	0.00
47.50	2.42	0.74	3.29	0.00	0.00	0.00
47.55	2.42	0.74	3.29	0.00	0.00	0.00
47.60	2.42	0.74	3.29	0.00	0.00	0.00
47.65	2.42	0.74	3.29	0.00	0.00	0.00
47.70	2.42	0.74	3.29	0.00	0.00	0.00
47.75	2.42	0.74	3.29	0.00	0.00	0.00
47.80	2.42	0.74	3.29	0.00	0.00	0.00
47.85	2.42	0.74	3.29	0.00	0.00	0.00
47.90	2.42	0.73	3.29	0.00	0.00	0.00
47.95	2.42	0.73	3.29	0.00	0.00	0.00
48.00	2.42	0.73	3.29	0.00	0.00	0.00
48.05	2.42	0.73	3.29	0.00	0.00	0.00
48.10	2.42	0.73	3.29	0.00	0.00	0.00
48.15	2.42	0.73	3.29	0.00	0.00	0.00
48.20	2.42	0.73	3.29	0.00	0.00	0.00
48.25	2.42	0.73	3.29	0.00	0.00	0.00
48.30	2.42	0.73	3.29	0.00	0.00	0.00
48.35	2.42	0.73	3.29	0.00	0.00	0.00
48.40	2.42	0.73	3.29	0.00	0.00	0.00
48.45	2.42	0.73	3.29	0.00	0.00	0.00
48.50	2.41	0.73	3.29	0.00	0.00	0.00
48.55	2.41	0.73	3.29	0.00	0.00	0.00
48.60	2.41	0.73	3.29	0.00	0.00	0.00
48.65	2.41	0.73	3.29	0.00	0.00	0.00
48.70	2.41	0.73	3.29	0.00	0.00	0.00
48.75	2.41	0.73	3.29	0.00	0.00	0.00
48.80	2.41	0.73	3.29	0.00	0.00	0.00
48.85	2.41	0.73	3.29	0.00	0.00	0.00
48.90	2.41	0.73	3.29	0.00	0.00	0.00
48.95	2.41	0.73	3.29	0.00	0.00	0.00
49.00	2.41	0.73	3.29	0.00	0.00	0.00
49.05	2.41	0.73	3.29	0.00	0.00	0.00
49.10	2.41	0.73	3.29	0.00	0.00	0.00
49.15	2.41	0.73	3.29	0.00	0.00	0.00
49.20	2.41	0.73	3.29	0.00	0.00	0.00
49.25	2.41	0.73	3.29	0.00	0.00	0.00
49.30	2.41	0.73	3.29	0.00	0.00	0.00
49.35	2.41	0.73	3.29	0.00	0.00	0.00
49.40	2.41	0.73	3.29	0.00	0.00	0.00
49.45	2.41	0.73	3.29	0.00	0.00	0.00
49.50	2.41	0.73	3.29	0.00	0.00	0.00
49.55	2.41	0.73	3.29	0.00	0.00	0.00
49.60	2.41	0.73	3.30	0.00	0.00	0.00
49.65	2.41	0.73	3.30	0.00	0.00	0.00
49.70	2.41	0.73	3.30	0.00	0.00	0.00
49.75	2.41	0.73	3.30	0.00	0.00	0.00
49.80	2.41	0.73	3.30	0.00	0.00	0.00
49.85	2.41	0.73	3.30	0.00	0.00	0.00
49.90	2.41	0.73	3.30	0.00	0.00	0.00
49.95	2.41	0.73	3.30	0.00	0.00	0.00
50.00	2.41	0.73	3.30	0.00	0.00	0.00

* F.S.<1, Liquefaction Potential Zone
(F.S. is limited to 5, CRR is limited to 2, CSR is limited to 2)

Units: Unit: qc, fs, Stress or Pressure = atm (1.0581tsf); Unit Weight = pcf; Depth = ft; Settlement = in.

1 atm (atmosphere) = 1 tsf (ton/ft2)
CRRm Cyclic resistance ratio from soils
CSRsF Cyclic stress ratio induced by a given earthquake (with user request factor of safety)
F.S. Factor of Safety against liquefaction, F.S.=CRRm/CSRsF

		BH4.sum
S_sat	Settlement from saturated sands	
S_dry	Settlement from Unsaturated Sands	
S_all	Total Settlement from Saturated and Unsaturated Sands	
NoLiq	No-Liquefy Soils	

LIQUEFACTION ANALYSIS

17-31-247-01

Hole No.=6 Water Depth=22 ft
Ground Improvement of Fill=5 ft

Magnitude=6.89
Acceleration=0.776g

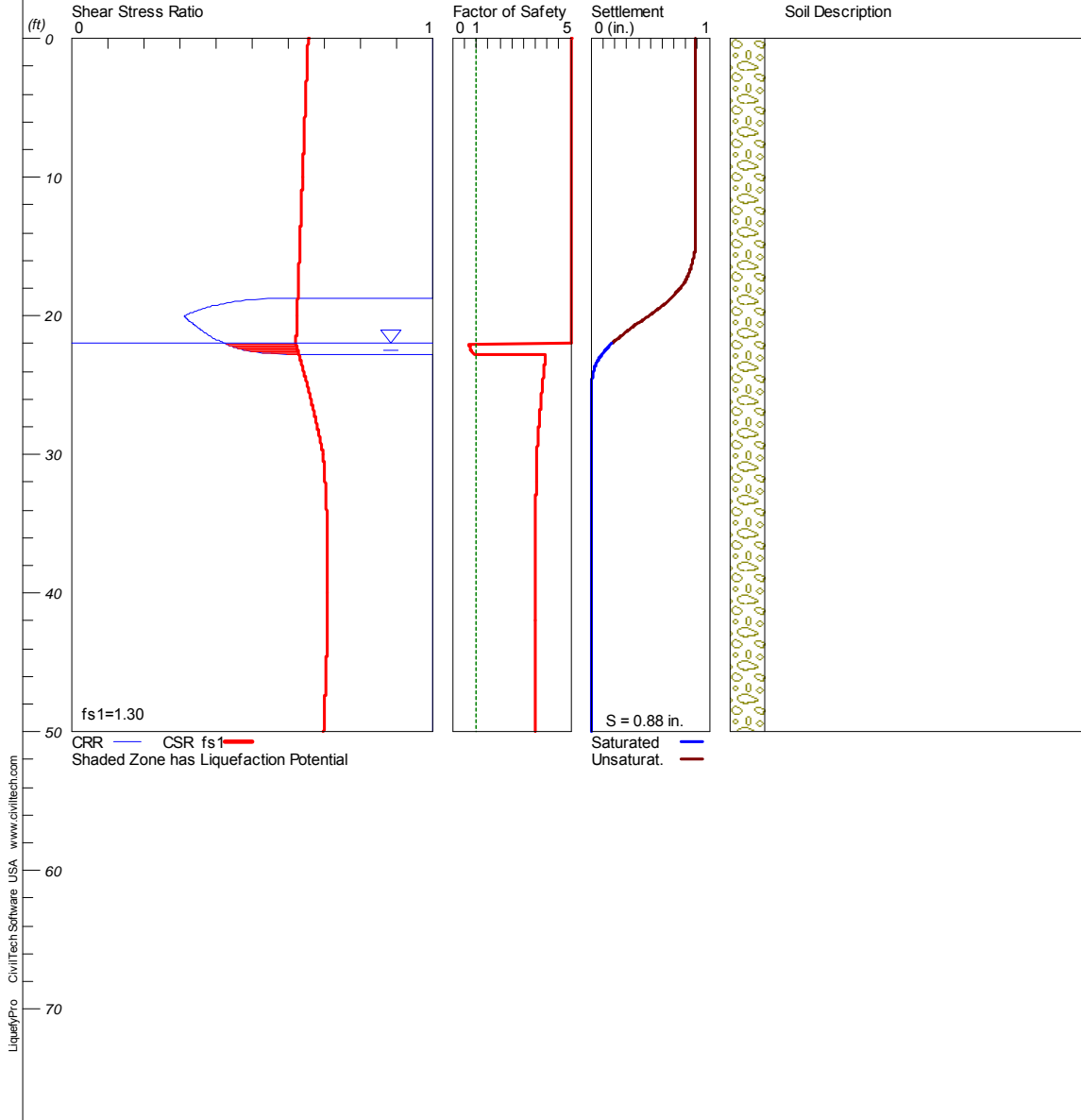

 LIQUEFACTION ANALYSIS SUMMARY
 Copyright by CivilTech Software
 www.civiltechsoftware.com

Font: Courier New, Regular, Size 8 is recommended for this report.
 Licensed to , 11/15/2017 1:40:32 PM

Input File Name: K:\Ram\17-31-247-00 MT SAC lot R&S\Parking Lot R\Liquefaction Analysis\BH6.liq
 Title: 17-31-247-01
 Subtitle: Parking Lor R Mt sac

Surface Elev.=
 Hole No.=6
 Depth of Hole= 50.00 ft
 Water Table during Earthquake= 22.00 ft
 Water Table during In-Situ Testing= 22.00 ft
 Max. Acceleration= 0.78 g
 Earthquake Magnitude= 6.89

Input Data:

Surface Elev.=
 Hole No.=6
 Depth of Hole=50.00 ft
 Water Table during Earthquake= 22.00 ft
 Water Table during In-Situ Testing= 22.00 ft
 Max. Acceleration=0.78 g
 Earthquake Magnitude=6.89
 No-Liquefiable Soils: CL, OL are Non-Liq. Soil

1. SPT or BPT Calculation.
 2. Settlement Analysis Method: Tokimatsu/Seed
 3. Fines Correction for Liquefaction: Modify Stark/Olson
 4. Fine Correction for Settlement: During Liquefaction*
 5. Settlement Calculation in: All zones*
 6. Hammer Energy Ratio, Ce = 1.25
 7. Borehole Diameter, Cb= 1
 8. Sampling Method, Cs= 1
 9. User request factor of safety (apply to CSR) , User= 1.3
 Plot one CSR curve (fs1=User)
 10. Use Curve Smoothing: Yes*
- * Recommended Options

Fill on Top= 5 ft Fill Unit Weight= 125 pcf
 Depth of this report is based on original ground surface, not based on fill
 1 atm (atmosphere) = 1 tsf (ton/ft2)

In-Situ Test Data:

Depth ft	SPT	gamma pcf	Fines %
0.00	50.00	122.00	NoLiq
5.00	50.00	110.00	NoLiq
10.00	21.00	100.00	NoLiq
15.00	16.00	96.00	NoLiq
20.00	10.00	115.00	36.00
25.00	10.00	120.00	NoLiq
30.00	50.00	125.00	50.00
35.00	64.00	120.00	71.00
40.00	50.00	117.00	71.00
45.00	37.00	110.00	71.00
50.00	50.00	90.00	71.00

Output Results:

Settlement of Saturated Sands=0.16 in.
 Settlement of Unsaturated Sands=0.72 in.
 Total Settlement of Saturated and Unsaturated Sands=0.88 in.
 Differential Settlement=0.441 to 0.582 in.

Depth ft	CRRm	CSRfs	F.S.	S_sat. in.	S_dry in.	S_all in.
0.00	2.00	0.66	5.00	0.16	0.72	0.88
3.00	2.00	0.65	5.00	0.16	0.72	0.88
6.00	2.00	0.65	5.00	0.16	0.72	0.88
9.00	2.00	0.64	5.00	0.16	0.72	0.88
12.00	2.00	0.64	5.00	0.16	0.72	0.88
15.00	2.48	0.63	5.00	0.16	0.72	0.88
18.00	2.48	0.63	5.00	0.16	0.59	0.75
21.00	0.36	0.62	5.00	0.16	0.15	0.32
24.00	2.48	0.64	3.86	0.02	0.00	0.02
27.00	2.48	0.67	3.69	0.00	0.00	0.00
30.00	2.48	0.70	3.56	0.00	0.00	0.00
33.00	2.48	0.71	3.52	0.00	0.00	0.00
36.00	2.48	0.71	3.50	0.00	0.00	0.00
39.00	2.49	0.71	3.50	0.00	0.00	0.00
42.00	2.47	0.71	3.48	0.00	0.00	0.00
45.00	2.45	0.71	3.47	0.00	0.00	0.00
48.00	2.44	0.70	3.47	0.00	0.00	0.00

* F.S.<1, Liquefaction Potential Zone
(F.S. is limited to 5, CRR is limited to 2, CSR is limited to 2)

Units: Unit: qc, fs, Stress or Pressure = atm (1.0581tsf); Unit Weight = pcf; Depth = ft; Settlement = in.

1 atm (atmosphere) = 1 tsf (ton/ft²)

CRRm Cyclic resistance ratio from soils
CSRsf Cyclic stress ratio induced by a given earthquake (with user request factor of safety)
F.S. Factor of Safety against liquefaction, F.S.=CRRm/CSRsf
S_sat Settlement from saturated sands
S_dry Settlement from Unsaturated Sands
S_all Total Settlement from Saturated and Unsaturated Sands
NoLiq No-Liquefy Soils

LIQUEFACTION ANALYSIS

17-31-247-01

Hole No.=11 Water Depth=22 ft
Ground Improvement of Fill=5 ft

Magnitude=6.89
Acceleration=0.776g

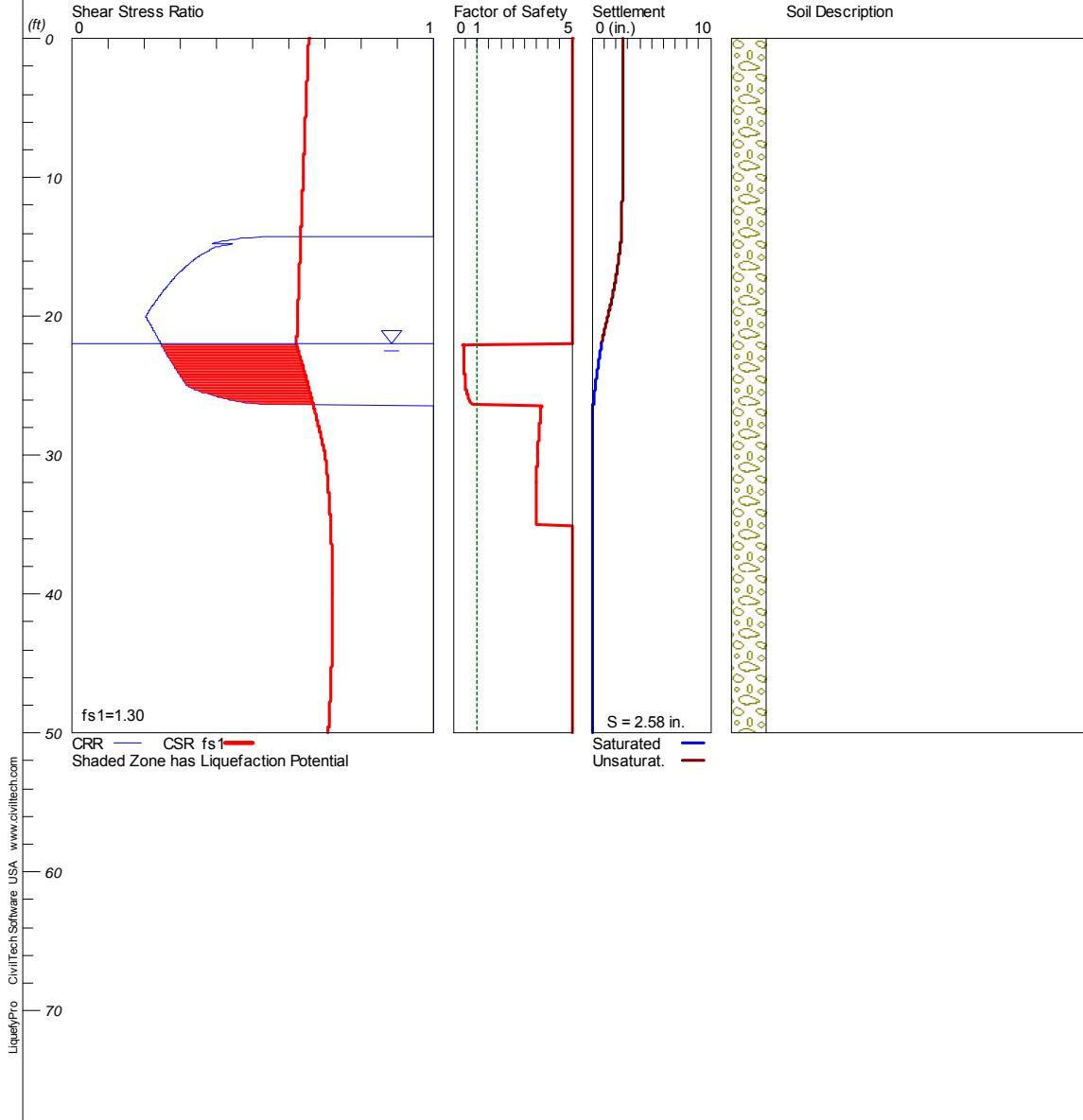

 LIQUEFACTION ANALYSIS SUMMARY
 Copyright by CivilTech Software
 www.civiltechsoftware.com

Font: Courier New, Regular, Size 8 is recommended for this report.
 Licensed to , 12/1/2017 12:44:26 PM

Input File Name: K:\Ram\17-31-247-00 MT SAC lot R&S\Parking Lot R\Liquefaction Analysis\BH11.liq
 Title: 17-31-247-01
 Subtitle: Parking Lor R Mt sac

Surface Elev.=
 Hole No.=11
 Depth of Hole= 50.00 ft
 Water Table during Earthquake= 22.00 ft
 Water Table during In-Situ Testing= 22.00 ft
 Max. Acceleration= 0.78 g
 Earthquake Magnitude= 6.89

Input Data:

Surface Elev.=
 Hole No.=11
 Depth of Hole=50.00 ft
 Water Table during Earthquake= 22.00 ft
 Water Table during In-Situ Testing= 22.00 ft
 Max. Acceleration=0.78 g
 Earthquake Magnitude=6.89
 No-Liquefiable Soils: CL, OL are Non-Liq. Soil

1. SPT or BPT Calculation.
 2. Settlement Analysis Method: Tokimatsu/Seed
 3. Fines Correction for Liquefaction: Modify Stark/Olson
 4. Fine Correction for Settlement: During Liquefaction*
 5. Settlement Calculation in: All zones*
 6. Hammer Energy Ratio, Ce = 1.25
 7. Borehole Diameter, Cb= 1
 8. Sampling Method, Cs= 1
 9. User request factor of safety (apply to CSR) , User= 1.3
 Plot one CSR curve (fs1=User)
 10. Use Curve Smoothing: Yes*
- * Recommended Options

Fill on Top= 5 ft Fill Unit Weight= 125 pcf
 Depth of this report is based on original ground surface, not based on fill
 1 atm (atmosphere) = 1 tsf (ton/ft2)

In-Situ Test Data:

Depth ft	SPT	gamma pcf	Fines %
0.00	50.00	110.00	NoLiq
5.00	50.00	110.00	NoLiq
10.00	17.50	88.00	NoLiq
15.00	10.00	109.00	36.00
20.00	5.00	110.00	36.00
25.00	12.60	104.00	29.00
30.00	27.00	110.00	55.00
35.00	18.20	110.00	NoLiq
40.00	15.00	110.00	NoLiq
45.00	50.00	110.00	NoLiq
50.00	39.00	110.00	NoLiq

Output Results:

Settlement of Saturated Sands=0.75 in.
 Settlement of Unsaturated Sands=1.83 in.
 Total Settlement of Saturated and Unsaturated Sands=2.58 in.
 Differential Settlement=1.289 to 1.702 in.

Depth ft	CRRm	CSRfs	F.S.	S_sat. in.	S_dry in.	S_all in.
0.00	2.00	0.66	5.00	0.75	1.83	2.58
0.05	2.00	0.66	5.00	0.75	1.83	2.58
0.10	2.00	0.66	5.00	0.75	1.83	2.58
0.15	2.00	0.66	5.00	0.75	1.83	2.58
0.20	2.00	0.66	5.00	0.75	1.83	2.58
0.25	2.00	0.66	5.00	0.75	1.83	2.58
0.30	2.00	0.66	5.00	0.75	1.83	2.58
0.35	2.00	0.66	5.00	0.75	1.83	2.58
0.40	2.00	0.66	5.00	0.75	1.83	2.58
0.45	2.00	0.66	5.00	0.75	1.83	2.58
0.50	2.00	0.65	5.00	0.75	1.83	2.58
0.55	2.00	0.65	5.00	0.75	1.83	2.58
0.60	2.00	0.65	5.00	0.75	1.83	2.58
0.65	2.00	0.65	5.00	0.75	1.83	2.58
0.70	2.00	0.65	5.00	0.75	1.83	2.58
0.75	2.00	0.65	5.00	0.75	1.83	2.58
0.80	2.00	0.65	5.00	0.75	1.83	2.58

9.85	2.00	0.64	5.00	0.75	1.83	2.58
9.90	2.00	0.64	5.00	0.75	1.83	2.58
9.95	2.00	0.64	5.00	0.75	1.83	2.58
10.00	2.48	0.64	5.00	0.75	1.83	2.58
10.05	2.48	0.64	5.00	0.75	1.83	2.58
10.10	2.48	0.64	5.00	0.75	1.83	2.58
10.15	2.48	0.64	5.00	0.75	1.83	2.58
10.20	2.48	0.64	5.00	0.75	1.83	2.57
10.25	2.48	0.64	5.00	0.75	1.83	2.57
10.30	2.48	0.64	5.00	0.75	1.82	2.57
10.35	2.48	0.64	5.00	0.75	1.82	2.57
10.40	2.48	0.64	5.00	0.75	1.82	2.56
10.45	2.48	0.64	5.00	0.75	1.81	2.56
10.50	2.48	0.64	5.00	0.75	1.81	2.56
10.55	2.48	0.64	5.00	0.75	1.81	2.55
10.60	2.48	0.64	5.00	0.75	1.80	2.55
10.65	2.48	0.64	5.00	0.75	1.80	2.55
10.70	2.48	0.64	5.00	0.75	1.80	2.54
10.75	2.48	0.64	5.00	0.75	1.79	2.54
10.80	2.48	0.64	5.00	0.75	1.79	2.54
10.85	2.48	0.64	5.00	0.75	1.79	2.53
10.90	2.48	0.64	5.00	0.75	1.78	2.53
10.95	2.48	0.64	5.00	0.75	1.78	2.53
11.00	2.48	0.64	5.00	0.75	1.78	2.52
11.05	2.48	0.64	5.00	0.75	1.77	2.52
11.10	2.48	0.64	5.00	0.75	1.77	2.52
11.15	2.48	0.64	5.00	0.75	1.77	2.52
11.20	2.48	0.64	5.00	0.75	1.77	2.52
11.25	2.48	0.64	5.00	0.75	1.77	2.52
11.30	2.48	0.64	5.00	0.75	1.77	2.52
11.35	2.48	0.64	5.00	0.75	1.77	2.52
11.40	2.48	0.64	5.00	0.75	1.77	2.52
11.45	2.48	0.64	5.00	0.75	1.77	2.51
11.50	2.48	0.64	5.00	0.75	1.77	2.51
11.55	2.48	0.64	5.00	0.75	1.77	2.51
11.60	2.48	0.64	5.00	0.75	1.77	2.51
11.65	2.48	0.64	5.00	0.75	1.77	2.51
11.70	2.48	0.64	5.00	0.75	1.77	2.51
11.75	2.48	0.64	5.00	0.75	1.76	2.51
11.80	2.48	0.64	5.00	0.75	1.76	2.51
11.85	2.48	0.64	5.00	0.75	1.76	2.51
11.90	2.48	0.64	5.00	0.75	1.76	2.51
11.95	2.48	0.64	5.00	0.75	1.76	2.51
12.00	2.48	0.64	5.00	0.75	1.76	2.51
12.05	2.48	0.64	5.00	0.75	1.76	2.51
12.10	2.48	0.64	5.00	0.75	1.76	2.51
12.15	2.48	0.64	5.00	0.75	1.76	2.51
12.20	2.48	0.64	5.00	0.75	1.76	2.50
12.25	2.48	0.64	5.00	0.75	1.76	2.50
12.30	2.48	0.64	5.00	0.75	1.76	2.50
12.35	2.48	0.64	5.00	0.75	1.76	2.50
12.40	2.48	0.64	5.00	0.75	1.76	2.50
12.45	2.48	0.64	5.00	0.75	1.75	2.50
12.50	2.48	0.64	5.00	0.75	1.75	2.50
12.55	2.48	0.64	5.00	0.75	1.75	2.50
12.60	2.48	0.64	5.00	0.75	1.75	2.50
12.65	2.48	0.64	5.00	0.75	1.75	2.50
12.70	2.48	0.64	5.00	0.75	1.75	2.50
12.75	2.48	0.64	5.00	0.75	1.75	2.50
12.80	2.48	0.64	5.00	0.75	1.75	2.49
12.85	2.48	0.64	5.00	0.75	1.75	2.49
12.90	2.48	0.64	5.00	0.75	1.75	2.49
12.95	2.48	0.64	5.00	0.75	1.75	2.49
13.00	2.48	0.64	5.00	0.75	1.74	2.49
13.05	2.48	0.64	5.00	0.75	1.74	2.49
13.10	2.48	0.64	5.00	0.75	1.74	2.49
13.15	2.48	0.64	5.00	0.75	1.74	2.49
13.20	2.48	0.64	5.00	0.75	1.74	2.49
13.25	2.48	0.64	5.00	0.75	1.74	2.48
13.30	2.48	0.64	5.00	0.75	1.74	2.48
13.35	2.48	0.64	5.00	0.75	1.73	2.48
13.40	2.48	0.64	5.00	0.75	1.73	2.48
13.45	2.48	0.64	5.00	0.75	1.73	2.48
13.50	2.48	0.64	5.00	0.75	1.73	2.48
13.55	2.48	0.64	5.00	0.75	1.73	2.47
13.60	2.48	0.63	5.00	0.75	1.73	2.47
13.65	2.48	0.63	5.00	0.75	1.72	2.47
13.70	2.48	0.63	5.00	0.75	1.72	2.47
13.75	2.48	0.63	5.00	0.75	1.72	2.46
13.80	2.48	0.63	5.00	0.75	1.72	2.46
13.85	2.48	0.63	5.00	0.75	1.71	2.46
13.90	2.48	0.63	5.00	0.75	1.71	2.46
13.95	2.48	0.63	5.00	0.75	1.71	2.45
14.00	2.48	0.63	5.00	0.75	1.71	2.45
14.05	2.48	0.63	5.00	0.75	1.70	2.45
14.10	2.48	0.63	5.00	0.75	1.70	2.44
14.15	2.48	0.63	5.00	0.75	1.69	2.44
14.20	2.48	0.63	5.00	0.75	1.69	2.44
14.25	2.48	0.63	5.00	0.75	1.69	2.43
14.30	0.53	0.63	5.00	0.75	1.68	2.43

14.35	0.49	0.63	5.00	0.75	1.68	2.42
14.40	0.47	0.63	5.00	0.75	1.67	2.42
14.45	0.45	0.63	5.00	0.75	1.67	2.42
14.50	0.44	0.63	5.00	0.75	1.66	2.41
14.55	0.43	0.63	5.00	0.75	1.66	2.40
14.60	0.42	0.63	5.00	0.75	1.65	2.40
14.65	0.41	0.63	5.00	0.75	1.65	2.39
14.70	0.40	0.63	5.00	0.75	1.64	2.39
14.75	0.39	0.63	5.00	0.75	1.63	2.38
14.80	0.44	0.63	5.00	0.75	1.63	2.37
14.85	0.43	0.63	5.00	0.75	1.62	2.37
14.90	0.42	0.63	5.00	0.75	1.61	2.36
14.95	0.41	0.63	5.00	0.75	1.61	2.35
15.00	0.40	0.63	5.00	0.75	1.60	2.35
15.05	0.39	0.63	5.00	0.75	1.59	2.34
15.10	0.39	0.63	5.00	0.75	1.59	2.33
15.15	0.39	0.63	5.00	0.75	1.58	2.33
15.20	0.38	0.63	5.00	0.75	1.57	2.32
15.25	0.38	0.63	5.00	0.75	1.56	2.31
15.30	0.38	0.63	5.00	0.75	1.56	2.30
15.35	0.37	0.63	5.00	0.75	1.55	2.30
15.40	0.37	0.63	5.00	0.75	1.54	2.29
15.45	0.37	0.63	5.00	0.75	1.53	2.28
15.50	0.36	0.63	5.00	0.75	1.53	2.27
15.55	0.36	0.63	5.00	0.75	1.52	2.27
15.60	0.36	0.63	5.00	0.75	1.51	2.26
15.65	0.35	0.63	5.00	0.75	1.50	2.25
15.70	0.35	0.63	5.00	0.75	1.50	2.24
15.75	0.35	0.63	5.00	0.75	1.49	2.23
15.80	0.35	0.63	5.00	0.75	1.48	2.23
15.85	0.34	0.63	5.00	0.75	1.47	2.22
15.90	0.34	0.63	5.00	0.75	1.46	2.21
15.95	0.34	0.63	5.00	0.75	1.46	2.20
16.00	0.33	0.63	5.00	0.75	1.45	2.19
16.05	0.33	0.63	5.00	0.75	1.44	2.19
16.10	0.33	0.63	5.00	0.75	1.43	2.18
16.15	0.33	0.63	5.00	0.75	1.42	2.17
16.20	0.33	0.63	5.00	0.75	1.41	2.16
16.25	0.32	0.63	5.00	0.75	1.41	2.15
16.30	0.32	0.63	5.00	0.75	1.40	2.14
16.35	0.32	0.63	5.00	0.75	1.39	2.13
16.40	0.32	0.63	5.00	0.75	1.38	2.13
16.45	0.31	0.63	5.00	0.75	1.37	2.12
16.50	0.31	0.63	5.00	0.75	1.36	2.11
16.55	0.31	0.63	5.00	0.75	1.35	2.10
16.60	0.31	0.63	5.00	0.75	1.34	2.09
16.65	0.31	0.63	5.00	0.75	1.33	2.08
16.70	0.30	0.63	5.00	0.75	1.33	2.07
16.75	0.30	0.63	5.00	0.75	1.32	2.06
16.80	0.30	0.63	5.00	0.75	1.31	2.05
16.85	0.30	0.63	5.00	0.75	1.30	2.04
16.90	0.30	0.63	5.00	0.75	1.29	2.03
16.95	0.29	0.63	5.00	0.75	1.28	2.03
17.00	0.29	0.63	5.00	0.75	1.27	2.02
17.05	0.29	0.63	5.00	0.75	1.26	2.01
17.10	0.29	0.63	5.00	0.75	1.25	2.00
17.15	0.29	0.63	5.00	0.75	1.24	1.99
17.20	0.28	0.63	5.00	0.75	1.23	1.98
17.25	0.28	0.63	5.00	0.75	1.22	1.97
17.30	0.28	0.63	5.00	0.75	1.21	1.96
17.35	0.28	0.63	5.00	0.75	1.20	1.95
17.40	0.28	0.63	5.00	0.75	1.19	1.94
17.45	0.28	0.63	5.00	0.75	1.18	1.93
17.50	0.27	0.63	5.00	0.75	1.17	1.92
17.55	0.27	0.63	5.00	0.75	1.16	1.91
17.60	0.27	0.63	5.00	0.75	1.15	1.90
17.65	0.27	0.63	5.00	0.75	1.14	1.89
17.70	0.27	0.63	5.00	0.75	1.13	1.87
17.75	0.27	0.63	5.00	0.75	1.12	1.86
17.80	0.26	0.63	5.00	0.75	1.11	1.85
17.85	0.26	0.63	5.00	0.75	1.10	1.84
17.90	0.26	0.63	5.00	0.75	1.09	1.83
17.95	0.26	0.63	5.00	0.75	1.07	1.82
18.00	0.26	0.63	5.00	0.75	1.06	1.81
18.05	0.26	0.63	5.00	0.75	1.05	1.80
18.10	0.26	0.63	5.00	0.75	1.04	1.79
18.15	0.25	0.63	5.00	0.75	1.03	1.78
18.20	0.25	0.63	5.00	0.75	1.02	1.76
18.25	0.25	0.63	5.00	0.75	1.01	1.75
18.30	0.25	0.63	5.00	0.75	1.00	1.74
18.35	0.25	0.63	5.00	0.75	0.98	1.73
18.40	0.25	0.63	5.00	0.75	0.97	1.72
18.45	0.25	0.63	5.00	0.75	0.96	1.71
18.50	0.24	0.63	5.00	0.75	0.95	1.69
18.55	0.24	0.63	5.00	0.75	0.94	1.68
18.60	0.24	0.63	5.00	0.75	0.92	1.67
18.65	0.24	0.63	5.00	0.75	0.91	1.66
18.70	0.24	0.63	5.00	0.75	0.90	1.65
18.75	0.24	0.63	5.00	0.75	0.89	1.63
18.80	0.24	0.63	5.00	0.75	0.87	1.62

18.85	0.23	0.63	5.00	0.75	0.86	1.61
18.90	0.23	0.63	5.00	0.75	0.85	1.60
18.95	0.23	0.63	5.00	0.75	0.84	1.58
19.00	0.23	0.63	5.00	0.75	0.82	1.57
19.05	0.23	0.63	5.00	0.75	0.81	1.56
19.10	0.23	0.63	5.00	0.75	0.80	1.54
19.15	0.23	0.63	5.00	0.75	0.78	1.53
19.20	0.22	0.63	5.00	0.75	0.77	1.52
19.25	0.22	0.63	5.00	0.75	0.76	1.50
19.30	0.22	0.63	5.00	0.75	0.74	1.49
19.35	0.22	0.63	5.00	0.75	0.73	1.48
19.40	0.22	0.63	5.00	0.75	0.72	1.46
19.45	0.22	0.63	5.00	0.75	0.70	1.45
19.50	0.22	0.63	5.00	0.75	0.69	1.44
19.55	0.22	0.63	5.00	0.75	0.68	1.42
19.60	0.21	0.63	5.00	0.75	0.66	1.41
19.65	0.21	0.63	5.00	0.75	0.65	1.39
19.70	0.21	0.63	5.00	0.75	0.63	1.38
19.75	0.21	0.63	5.00	0.75	0.62	1.37
19.80	0.21	0.63	5.00	0.75	0.60	1.35
19.85	0.21	0.63	5.00	0.75	0.59	1.34
19.90	0.21	0.63	5.00	0.75	0.58	1.32
19.95	0.21	0.63	5.00	0.75	0.56	1.31
20.00	0.20	0.63	5.00	0.75	0.55	1.29
20.05	0.21	0.63	5.00	0.75	0.53	1.28
20.10	0.21	0.62	5.00	0.75	0.52	1.26
20.15	0.21	0.62	5.00	0.75	0.50	1.25
20.20	0.21	0.62	5.00	0.75	0.49	1.23
20.25	0.21	0.62	5.00	0.75	0.47	1.22
20.30	0.21	0.62	5.00	0.75	0.46	1.20
20.35	0.21	0.62	5.00	0.75	0.44	1.19
20.40	0.21	0.62	5.00	0.75	0.43	1.17
20.45	0.21	0.62	5.00	0.75	0.41	1.16
20.50	0.22	0.62	5.00	0.75	0.40	1.15
20.55	0.22	0.62	5.00	0.75	0.38	1.13
20.60	0.22	0.62	5.00	0.75	0.37	1.12
20.65	0.22	0.62	5.00	0.75	0.36	1.10
20.70	0.22	0.62	5.00	0.75	0.34	1.09
20.75	0.22	0.62	5.00	0.75	0.33	1.08
20.80	0.22	0.62	5.00	0.75	0.32	1.06
20.85	0.22	0.62	5.00	0.75	0.30	1.05
20.90	0.22	0.62	5.00	0.75	0.29	1.03
20.95	0.23	0.62	5.00	0.75	0.28	1.02
21.00	0.23	0.62	5.00	0.75	0.26	1.01
21.05	0.23	0.62	5.00	0.75	0.25	0.99
21.10	0.23	0.62	5.00	0.75	0.24	0.98
21.15	0.23	0.62	5.00	0.75	0.22	0.97
21.20	0.23	0.62	5.00	0.75	0.21	0.96
21.25	0.23	0.62	5.00	0.75	0.20	0.94
21.30	0.23	0.62	5.00	0.75	0.18	0.93
21.35	0.23	0.62	5.00	0.75	0.17	0.92
21.40	0.23	0.62	5.00	0.75	0.16	0.90
21.45	0.24	0.62	5.00	0.75	0.15	0.89
21.50	0.24	0.62	5.00	0.75	0.13	0.88
21.55	0.24	0.62	5.00	0.75	0.12	0.87
21.60	0.24	0.62	5.00	0.75	0.11	0.85
21.65	0.24	0.62	5.00	0.75	0.10	0.84
21.70	0.24	0.62	5.00	0.75	0.08	0.83
21.75	0.24	0.62	5.00	0.75	0.07	0.82
21.80	0.24	0.62	5.00	0.75	0.06	0.81
21.85	0.24	0.62	5.00	0.75	0.05	0.79
21.90	0.24	0.62	5.00	0.75	0.04	0.78
21.95	0.25	0.62	5.00	0.75	0.02	0.77
22.00	0.25	0.62	5.00	0.75	0.01	0.76
22.05	0.25	0.62	0.40*	0.75	0.00	0.75
22.10	0.25	0.62	0.40*	0.74	0.00	0.74
22.15	0.25	0.62	0.40*	0.73	0.00	0.73
22.20	0.25	0.62	0.40*	0.72	0.00	0.72
22.25	0.25	0.62	0.40*	0.71	0.00	0.71
22.30	0.25	0.62	0.41*	0.70	0.00	0.70
22.35	0.25	0.63	0.41*	0.69	0.00	0.69
22.40	0.26	0.63	0.41*	0.68	0.00	0.68
22.45	0.26	0.63	0.41*	0.67	0.00	0.67
22.50	0.26	0.63	0.41*	0.66	0.00	0.66
22.55	0.26	0.63	0.41*	0.65	0.00	0.65
22.60	0.26	0.63	0.41*	0.64	0.00	0.64
22.65	0.26	0.63	0.42*	0.63	0.00	0.63
22.70	0.26	0.63	0.42*	0.62	0.00	0.62
22.75	0.26	0.63	0.42*	0.61	0.00	0.61
22.80	0.26	0.63	0.42*	0.60	0.00	0.60
22.85	0.27	0.63	0.42*	0.59	0.00	0.59
22.90	0.27	0.63	0.42*	0.59	0.00	0.59
22.95	0.27	0.63	0.42*	0.58	0.00	0.58
23.00	0.27	0.63	0.43*	0.57	0.00	0.57
23.05	0.27	0.63	0.43*	0.56	0.00	0.56
23.10	0.27	0.63	0.43*	0.55	0.00	0.55
23.15	0.27	0.63	0.43*	0.54	0.00	0.54
23.20	0.27	0.64	0.43*	0.53	0.00	0.53
23.25	0.28	0.64	0.43*	0.52	0.00	0.52
23.30	0.28	0.64	0.43*	0.51	0.00	0.51

23.35	0.28	0.64	0.44*	0.51	0.00	0.51
23.40	0.28	0.64	0.44*	0.50	0.00	0.50
23.45	0.28	0.64	0.44*	0.49	0.00	0.49
23.50	0.28	0.64	0.44*	0.48	0.00	0.48
23.55	0.28	0.64	0.44*	0.47	0.00	0.47
23.60	0.28	0.64	0.44*	0.46	0.00	0.46
23.65	0.28	0.64	0.45*	0.45	0.00	0.45
23.70	0.29	0.64	0.45*	0.44	0.00	0.44
23.75	0.29	0.64	0.45*	0.44	0.00	0.44
23.80	0.29	0.64	0.45*	0.43	0.00	0.43
23.85	0.29	0.64	0.45*	0.42	0.00	0.42
23.90	0.29	0.64	0.45*	0.41	0.00	0.41
23.95	0.29	0.64	0.45*	0.40	0.00	0.40
24.00	0.29	0.64	0.46*	0.39	0.00	0.39
24.05	0.29	0.64	0.46*	0.39	0.00	0.39
24.10	0.30	0.65	0.46*	0.38	0.00	0.38
24.15	0.30	0.65	0.46*	0.37	0.00	0.37
24.20	0.30	0.65	0.46*	0.36	0.00	0.36
24.25	0.30	0.65	0.46*	0.35	0.00	0.35
24.30	0.30	0.65	0.47*	0.34	0.00	0.34
24.35	0.30	0.65	0.47*	0.34	0.00	0.34
24.40	0.30	0.65	0.47*	0.33	0.00	0.33
24.45	0.30	0.65	0.47*	0.32	0.00	0.32
24.50	0.31	0.65	0.47*	0.31	0.00	0.31
24.55	0.31	0.65	0.47*	0.30	0.00	0.30
24.60	0.31	0.65	0.47*	0.30	0.00	0.30
24.65	0.31	0.65	0.48*	0.29	0.00	0.29
24.70	0.31	0.65	0.48*	0.28	0.00	0.28
24.75	0.31	0.65	0.48*	0.27	0.00	0.27
24.80	0.31	0.65	0.48*	0.26	0.00	0.26
24.85	0.32	0.65	0.48*	0.26	0.00	0.26
24.90	0.32	0.65	0.48*	0.25	0.00	0.25
24.95	0.32	0.65	0.49*	0.24	0.00	0.24
25.00	0.32	0.65	0.49*	0.23	0.00	0.23
25.05	0.32	0.66	0.49*	0.22	0.00	0.22
25.10	0.33	0.66	0.50*	0.22	0.00	0.22
25.15	0.33	0.66	0.51*	0.21	0.00	0.21
25.20	0.34	0.66	0.51*	0.20	0.00	0.20
25.25	0.34	0.66	0.52*	0.19	0.00	0.19
25.30	0.35	0.66	0.53*	0.19	0.00	0.19
25.35	0.35	0.66	0.53*	0.18	0.00	0.18
25.40	0.36	0.66	0.54*	0.17	0.00	0.17
25.45	0.36	0.66	0.55*	0.17	0.00	0.17
25.50	0.37	0.66	0.56*	0.16	0.00	0.16
25.55	0.37	0.66	0.57*	0.15	0.00	0.15
25.60	0.38	0.66	0.57*	0.14	0.00	0.14
25.65	0.39	0.66	0.58*	0.14	0.00	0.14
25.70	0.39	0.66	0.59*	0.13	0.00	0.13
25.75	0.40	0.66	0.60*	0.12	0.00	0.12
25.80	0.40	0.66	0.61*	0.12	0.00	0.12
25.85	0.41	0.66	0.62*	0.11	0.00	0.11
25.90	0.42	0.66	0.63*	0.11	0.00	0.11
25.95	0.43	0.66	0.64*	0.10	0.00	0.10
26.00	0.44	0.66	0.66*	0.09	0.00	0.09
26.05	0.44	0.67	0.67*	0.09	0.00	0.09
26.10	0.45	0.67	0.68*	0.08	0.00	0.08
26.15	0.47	0.67	0.70*	0.08	0.00	0.08
26.20	0.48	0.67	0.72*	0.07	0.00	0.07
26.25	0.50	0.67	0.75*	0.07	0.00	0.07
26.30	0.52	0.67	0.78*	0.06	0.00	0.06
26.35	0.57	0.67	0.85*	0.06	0.00	0.06
26.40	2.48	0.67	3.71	0.05	0.00	0.05
26.45	2.48	0.67	3.71	0.05	0.00	0.05
26.50	2.48	0.67	3.71	0.04	0.00	0.04
26.55	2.48	0.67	3.71	0.04	0.00	0.04
26.60	2.48	0.67	3.70	0.04	0.00	0.04
26.65	2.48	0.67	3.70	0.03	0.00	0.03
26.70	2.48	0.67	3.70	0.03	0.00	0.03
26.75	2.48	0.67	3.69	0.03	0.00	0.03
26.80	2.48	0.67	3.69	0.02	0.00	0.02
26.85	2.48	0.67	3.69	0.02	0.00	0.02
26.90	2.48	0.67	3.69	0.02	0.00	0.02
26.95	2.48	0.67	3.68	0.02	0.00	0.02
27.00	2.48	0.67	3.68	0.01	0.00	0.01
27.05	2.48	0.68	3.68	0.01	0.00	0.01
27.10	2.48	0.68	3.68	0.01	0.00	0.01
27.15	2.48	0.68	3.67	0.01	0.00	0.01
27.20	2.48	0.68	3.67	0.01	0.00	0.01
27.25	2.48	0.68	3.67	0.01	0.00	0.01
27.30	2.48	0.68	3.67	0.01	0.00	0.01
27.35	2.48	0.68	3.66	0.01	0.00	0.01
27.40	2.48	0.68	3.66	0.01	0.00	0.01
27.45	2.48	0.68	3.66	0.00	0.00	0.00
27.50	2.48	0.68	3.66	0.00	0.00	0.00
27.55	2.48	0.68	3.65	0.00	0.00	0.00
27.60	2.48	0.68	3.65	0.00	0.00	0.00
27.65	2.48	0.68	3.65	0.00	0.00	0.00
27.70	2.48	0.68	3.65	0.00	0.00	0.00
27.75	2.48	0.68	3.64	0.00	0.00	0.00
27.80	2.48	0.68	3.64	0.00	0.00	0.00

45.85	2.00	0.72	5.00	0.00	0.00	0.00
45.90	2.00	0.72	5.00	0.00	0.00	0.00
45.95	2.00	0.72	5.00	0.00	0.00	0.00
46.00	2.00	0.72	5.00	0.00	0.00	0.00
46.05	2.00	0.72	5.00	0.00	0.00	0.00
46.10	2.00	0.72	5.00	0.00	0.00	0.00
46.15	2.00	0.72	5.00	0.00	0.00	0.00
46.20	2.00	0.72	5.00	0.00	0.00	0.00
46.25	2.00	0.72	5.00	0.00	0.00	0.00
46.30	2.00	0.72	5.00	0.00	0.00	0.00
46.35	2.00	0.72	5.00	0.00	0.00	0.00
46.40	2.00	0.72	5.00	0.00	0.00	0.00
46.45	2.00	0.72	5.00	0.00	0.00	0.00
46.50	2.00	0.72	5.00	0.00	0.00	0.00
46.55	2.00	0.72	5.00	0.00	0.00	0.00
46.60	2.00	0.72	5.00	0.00	0.00	0.00
46.65	2.00	0.72	5.00	0.00	0.00	0.00
46.70	2.00	0.72	5.00	0.00	0.00	0.00
46.75	2.00	0.72	5.00	0.00	0.00	0.00
46.80	2.00	0.72	5.00	0.00	0.00	0.00
46.85	2.00	0.72	5.00	0.00	0.00	0.00
46.90	2.00	0.72	5.00	0.00	0.00	0.00
46.95	2.00	0.72	5.00	0.00	0.00	0.00
47.00	2.00	0.72	5.00	0.00	0.00	0.00
47.05	2.00	0.72	5.00	0.00	0.00	0.00
47.10	2.00	0.72	5.00	0.00	0.00	0.00
47.15	2.00	0.72	5.00	0.00	0.00	0.00
47.20	2.00	0.72	5.00	0.00	0.00	0.00
47.25	2.00	0.72	5.00	0.00	0.00	0.00
47.30	2.00	0.72	5.00	0.00	0.00	0.00
47.35	2.00	0.72	5.00	0.00	0.00	0.00
47.40	2.00	0.72	5.00	0.00	0.00	0.00
47.45	2.00	0.72	5.00	0.00	0.00	0.00
47.50	2.00	0.72	5.00	0.00	0.00	0.00
47.55	2.00	0.72	5.00	0.00	0.00	0.00
47.60	2.00	0.72	5.00	0.00	0.00	0.00
47.65	2.00	0.72	5.00	0.00	0.00	0.00
47.70	2.00	0.72	5.00	0.00	0.00	0.00
47.75	2.00	0.72	5.00	0.00	0.00	0.00
47.80	2.00	0.71	5.00	0.00	0.00	0.00
47.85	2.00	0.71	5.00	0.00	0.00	0.00
47.90	2.00	0.71	5.00	0.00	0.00	0.00
47.95	2.00	0.71	5.00	0.00	0.00	0.00
48.00	2.00	0.71	5.00	0.00	0.00	0.00
48.05	2.00	0.71	5.00	0.00	0.00	0.00
48.10	2.00	0.71	5.00	0.00	0.00	0.00
48.15	2.00	0.71	5.00	0.00	0.00	0.00
48.20	2.00	0.71	5.00	0.00	0.00	0.00
48.25	2.00	0.71	5.00	0.00	0.00	0.00
48.30	2.00	0.71	5.00	0.00	0.00	0.00
48.35	2.00	0.71	5.00	0.00	0.00	0.00
48.40	2.00	0.71	5.00	0.00	0.00	0.00
48.45	2.00	0.71	5.00	0.00	0.00	0.00
48.50	2.00	0.71	5.00	0.00	0.00	0.00
48.55	2.00	0.71	5.00	0.00	0.00	0.00
48.60	2.00	0.71	5.00	0.00	0.00	0.00
48.65	2.00	0.71	5.00	0.00	0.00	0.00
48.70	2.00	0.71	5.00	0.00	0.00	0.00
48.75	2.00	0.71	5.00	0.00	0.00	0.00
48.80	2.00	0.71	5.00	0.00	0.00	0.00
48.85	2.00	0.71	5.00	0.00	0.00	0.00
48.90	2.00	0.71	5.00	0.00	0.00	0.00
48.95	2.00	0.71	5.00	0.00	0.00	0.00
49.00	2.00	0.71	5.00	0.00	0.00	0.00
49.05	2.00	0.71	5.00	0.00	0.00	0.00
49.10	2.00	0.71	5.00	0.00	0.00	0.00
49.15	2.00	0.71	5.00	0.00	0.00	0.00
49.20	2.00	0.71	5.00	0.00	0.00	0.00
49.25	2.00	0.71	5.00	0.00	0.00	0.00
49.30	2.00	0.71	5.00	0.00	0.00	0.00
49.35	2.00	0.71	5.00	0.00	0.00	0.00
49.40	2.00	0.71	5.00	0.00	0.00	0.00
49.45	2.00	0.71	5.00	0.00	0.00	0.00
49.50	2.00	0.71	5.00	0.00	0.00	0.00
49.55	2.00	0.71	5.00	0.00	0.00	0.00
49.60	2.00	0.71	5.00	0.00	0.00	0.00
49.65	2.00	0.71	5.00	0.00	0.00	0.00
49.70	2.00	0.71	5.00	0.00	0.00	0.00
49.75	2.00	0.71	5.00	0.00	0.00	0.00
49.80	2.00	0.71	5.00	0.00	0.00	0.00
49.85	2.00	0.71	5.00	0.00	0.00	0.00
49.90	2.00	0.71	5.00	0.00	0.00	0.00
49.95	2.00	0.71	5.00	0.00	0.00	0.00
50.00	2.00	0.71	5.00	0.00	0.00	0.00

* F.S.<1, Liquefaction Potential Zone
(F.S. is limited to 5, CRR is limited to 2, CSR is limited to 2)

Units: Unit: qc, fs, Stress or Pressure = atm (1.0581tsf); Unit Weight = pcf; Depth = ft; Settlement = in.

BH11.sum

1 atm (atmosphere) = 1 tsf (ton/ft²)
CRRm Cyclic resistance ratio from soils
CSRsf Cyclic stress ratio induced by a given earthquake (with user request factor of safety)
F.S. Factor of Safety against liquefaction, F.S.=CRRm/CSRsf
S_sat Settlement from saturated sands
S_dry Settlement from Unsaturated Sands
S_all Total Settlement from Saturated and Unsaturated Sands
NOliq No-Liquefy Soils

LIQUEFACTION ANALYSIS

17-31-247-01

Hole No.=CPT 9 Water Depth=22 ft

Magnitude=6.89
Acceleration=0.776g

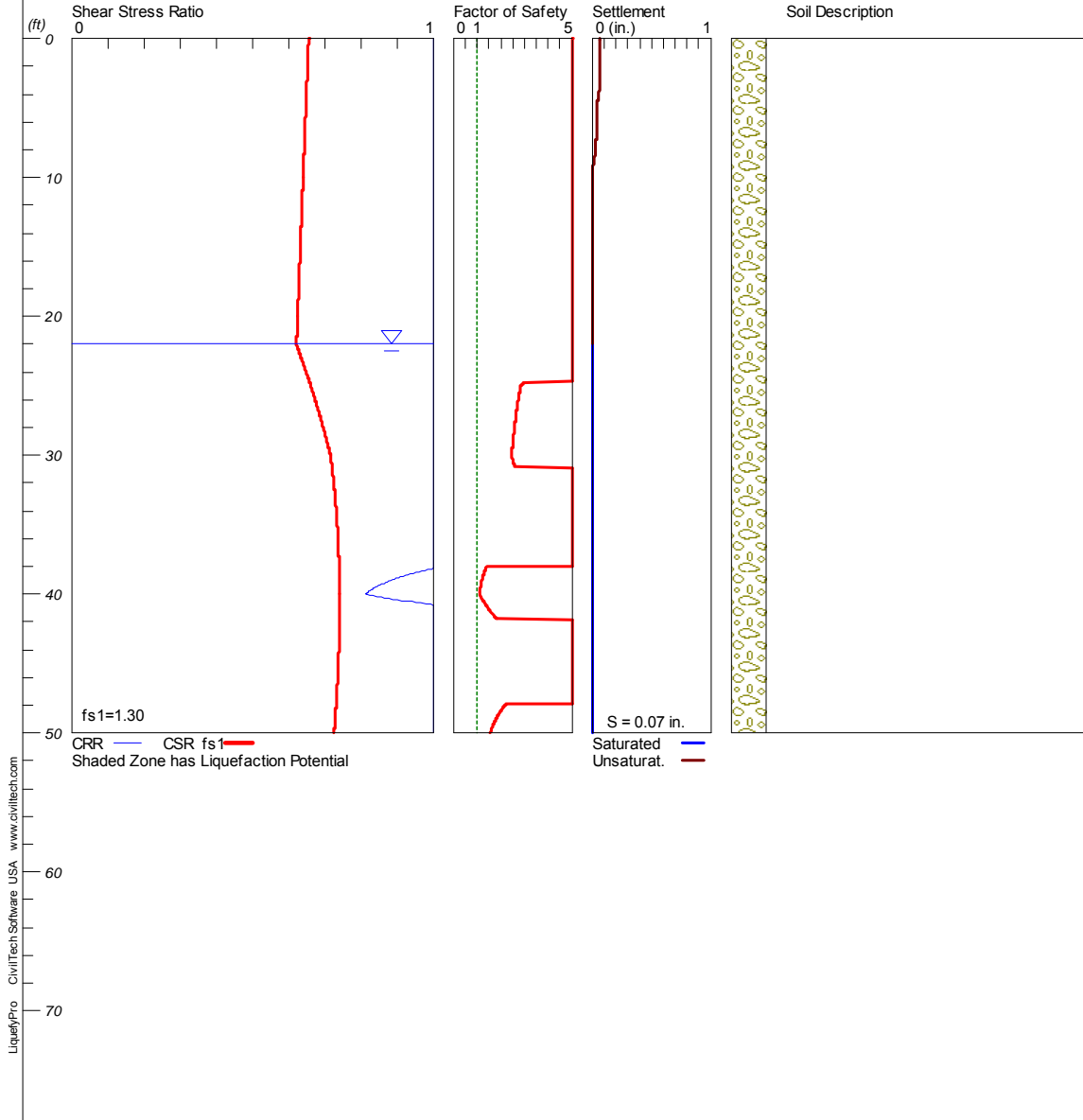

 LIQUEFACTION ANALYSIS SUMMARY
 Copyright by CivilTech Software
 www.civiltechsoftware.com

Font: Courier New, Regular, Size 8 is recommended for this report.
 Licensed to , 10/27/2017 9:49:40 AM

Input File Name: K:\Ram\17-31-247-00 MT SAC lot R&S\Parking Lot R\Liquefaction Analysis\CPT 9.liq
 Title: 17-31-247-01
 Subtitle: Parking Lot R Mt sac

Surface Elev.=
 Hole No.=CPT 9
 Depth of Hole= 50.00 ft
 Water Table during Earthquake= 22.00 ft
 Water Table during In-Situ Testing= 24.00 ft
 Max. Acceleration= 0.78 g
 Earthquake Magnitude= 6.89

Input Data:

Surface Elev.=
 Hole No.=CPT 9
 Depth of Hole=50.00 ft
 Water Table during Earthquake= 22.00 ft
 Water Table during In-Situ Testing= 24.00 ft
 Max. Acceleration=0.78 g
 Earthquake Magnitude=6.89
 No-Liquefiable Soils: CL, OL are Non-Liq. Soil

1. CPT Calculation Method: Modify Robertson*
 2. Settlement Analysis Method: Ishihara / Yoshimine
 3. Fines Correction for Liquefaction: Stark/Olson et al.*
 4. Fine Correction for Settlement: During Liquefaction*
 5. Settlement Calculation in: All zones*
 9. User request factor of safety (apply to CSR) , User= 1.3
 Plot one CSR curve (fs1=User)
 10. Use Curve Smoothing: Yes*
- * Recommended Options

In-Situ Test Data:

Depth ft	qc atm	fs atm	Rf pcf	gamma %	Fines mm	D50
0.00	57.50	1.88	3.27	110.00	0.00	0.50
5.00	26.90	1.36	5.06	110.00	0.00	0.50
10.00	28.70	1.57	5.47	110.00	0.00	0.50
15.00	33.80	1.88	5.56	110.00	0.00	0.50
20.00	16.20	0.73	4.51	110.00	0.00	0.50
25.00	71.90	3.60	5.01	115.00	0.00	0.50
30.00	83.30	4.18	5.02	115.00	0.00	0.50
35.00	50.40	2.50	4.96	115.00	0.00	0.50
40.00	89.10	3.50	3.93	115.00	0.00	0.50
45.00	82.30	5.00	6.08	120.00	0.00	0.50
50.00	114.70	5.00	4.36	120.00	0.00	0.50

Modify Robertson method generates Fines from qc/fs. Inputted Fines are not relevant.

Output Results:

Settlement of Saturated Sands=0.00 in.
 Settlement of Unsaturated Sands=0.07 in.
 Total Settlement of Saturated and Unsaturated Sands=0.07 in.
 Differential Settlement=0.033 to 0.044 in.

Depth ft	CRRm	CSRfs	F.S.	S_sat. in.	S_dry in.	S_all in.
0.00	2.00	0.66	5.00	0.00	0.07	0.07
0.05	2.58	0.66	5.00	0.00	0.07	0.07
0.10	2.58	0.66	5.00	0.00	0.07	0.07
0.15	2.58	0.66	5.00	0.00	0.07	0.07
0.20	2.58	0.66	5.00	0.00	0.07	0.07
0.25	2.58	0.66	5.00	0.00	0.07	0.07
0.30	2.58	0.66	5.00	0.00	0.07	0.07
0.35	2.58	0.66	5.00	0.00	0.07	0.07
0.40	2.58	0.66	5.00	0.00	0.07	0.07
0.45	2.58	0.66	5.00	0.00	0.07	0.07
0.50	2.58	0.65	5.00	0.00	0.07	0.07
0.55	2.58	0.65	5.00	0.00	0.07	0.07
0.60	2.58	0.65	5.00	0.00	0.07	0.07
0.65	2.58	0.65	5.00	0.00	0.07	0.07
0.70	2.58	0.65	5.00	0.00	0.07	0.07
0.75	2.58	0.65	5.00	0.00	0.07	0.07
0.80	2.58	0.65	5.00	0.00	0.07	0.07
0.85	2.58	0.65	5.00	0.00	0.07	0.07
0.90	2.58	0.65	5.00	0.00	0.07	0.07
0.95	2.58	0.65	5.00	0.00	0.07	0.07
1.00	2.58	0.65	5.00	0.00	0.07	0.07
1.05	2.58	0.65	5.00	0.00	0.07	0.07
1.10	2.58	0.65	5.00	0.00	0.07	0.07

1.15	2.58	0.65	5.00	0.00	0.07	0.07
1.20	2.58	0.65	5.00	0.00	0.07	0.07
1.25	2.58	0.65	5.00	0.00	0.07	0.07
1.30	2.57	0.65	5.00	0.00	0.06	0.06
1.35	2.46	0.65	5.00	0.00	0.06	0.06
1.40	2.35	0.65	5.00	0.00	0.06	0.06
1.45	2.25	0.65	5.00	0.00	0.06	0.06
1.50	2.16	0.65	5.00	0.00	0.06	0.06
1.55	2.08	0.65	5.00	0.00	0.06	0.06
1.60	2.00	0.65	5.00	0.00	0.06	0.06
1.65	1.93	0.65	5.00	0.00	0.06	0.06
1.70	1.86	0.65	5.00	0.00	0.06	0.06
1.75	1.80	0.65	5.00	0.00	0.06	0.06
1.80	1.74	0.65	5.00	0.00	0.06	0.06
1.85	1.69	0.65	5.00	0.00	0.06	0.06
1.90	1.64	0.65	5.00	0.00	0.06	0.06
1.95	1.59	0.65	5.00	0.00	0.06	0.06
2.00	1.55	0.65	5.00	0.00	0.06	0.06
2.05	1.51	0.65	5.00	0.00	0.06	0.06
2.10	1.47	0.65	5.00	0.00	0.06	0.06
2.15	1.43	0.65	5.00	0.00	0.06	0.06
2.20	1.40	0.65	5.00	0.00	0.06	0.06
2.25	1.37	0.65	5.00	0.00	0.06	0.06
2.30	1.34	0.65	5.00	0.00	0.06	0.06
2.35	1.31	0.65	5.00	0.00	0.06	0.06
2.40	1.28	0.65	5.00	0.00	0.06	0.06
2.45	1.26	0.65	5.00	0.00	0.06	0.06
2.50	1.24	0.65	5.00	0.00	0.06	0.06
2.55	1.21	0.65	5.00	0.00	0.06	0.06
2.60	1.19	0.65	5.00	0.00	0.06	0.06
2.65	1.18	0.65	5.00	0.00	0.06	0.06
2.70	1.16	0.65	5.00	0.00	0.06	0.06
2.75	1.14	0.65	5.00	0.00	0.06	0.06
2.80	1.13	0.65	5.00	0.00	0.06	0.06
2.85	1.11	0.65	5.00	0.00	0.06	0.06
2.90	1.10	0.65	5.00	0.00	0.06	0.06
2.95	1.09	0.65	5.00	0.00	0.06	0.06
3.00	1.08	0.65	5.00	0.00	0.06	0.06
3.05	1.07	0.65	5.00	0.00	0.06	0.06
3.10	1.06	0.65	5.00	0.00	0.06	0.06
3.15	1.05	0.65	5.00	0.00	0.06	0.06
3.20	1.05	0.65	5.00	0.00	0.06	0.06
3.25	1.04	0.65	5.00	0.00	0.06	0.06
3.30	1.03	0.65	5.00	0.00	0.06	0.06
3.35	1.03	0.65	5.00	0.00	0.06	0.06
3.40	1.03	0.65	5.00	0.00	0.06	0.06
3.45	1.03	0.65	5.00	0.00	0.06	0.06
3.50	1.03	0.65	5.00	0.00	0.06	0.06
3.55	1.03	0.65	5.00	0.00	0.06	0.06
3.60	1.03	0.65	5.00	0.00	0.06	0.06
3.65	1.03	0.65	5.00	0.00	0.06	0.06
3.70	1.04	0.65	5.00	0.00	0.06	0.06
3.75	1.04	0.65	5.00	0.00	0.06	0.06
3.80	1.05	0.65	5.00	0.00	0.05	0.05
3.85	1.06	0.65	5.00	0.00	0.05	0.05
3.90	1.07	0.65	5.00	0.00	0.05	0.05
3.95	1.08	0.65	5.00	0.00	0.05	0.05
4.00	1.10	0.65	5.00	0.00	0.05	0.05
4.05	1.12	0.65	5.00	0.00	0.05	0.05
4.10	1.14	0.65	5.00	0.00	0.05	0.05
4.15	1.16	0.65	5.00	0.00	0.05	0.05
4.20	1.18	0.65	5.00	0.00	0.05	0.05
4.25	1.21	0.65	5.00	0.00	0.05	0.05
4.30	1.24	0.65	5.00	0.00	0.05	0.05
4.35	1.28	0.65	5.00	0.00	0.05	0.05
4.40	1.32	0.65	5.00	0.00	0.04	0.04
4.45	1.37	0.65	5.00	0.00	0.04	0.04
4.50	1.42	0.65	5.00	0.00	0.04	0.04
4.55	1.48	0.65	5.00	0.00	0.04	0.04
4.60	1.55	0.65	5.00	0.00	0.04	0.04
4.65	1.63	0.65	5.00	0.00	0.04	0.04
4.70	1.72	0.65	5.00	0.00	0.04	0.04
4.75	1.82	0.65	5.00	0.00	0.04	0.04
4.80	1.95	0.65	5.00	0.00	0.04	0.04
4.85	2.09	0.65	5.00	0.00	0.04	0.04
4.90	2.26	0.65	5.00	0.00	0.04	0.04
4.95	2.33	0.65	5.00	0.00	0.04	0.04
5.00	1.76	0.65	5.00	0.00	0.04	0.04
5.05	1.78	0.65	5.00	0.00	0.04	0.04
5.10	1.79	0.65	5.00	0.00	0.04	0.04
5.15	1.81	0.65	5.00	0.00	0.04	0.04
5.20	1.82	0.65	5.00	0.00	0.04	0.04
5.25	1.84	0.65	5.00	0.00	0.04	0.04
5.30	1.85	0.65	5.00	0.00	0.04	0.04
5.35	1.87	0.65	5.00	0.00	0.04	0.04
5.40	1.89	0.65	5.00	0.00	0.04	0.04
5.45	1.91	0.65	5.00	0.00	0.04	0.04
5.50	1.92	0.65	5.00	0.00	0.04	0.04
5.55	1.94	0.65	5.00	0.00	0.04	0.04
5.60	1.96	0.65	5.00	0.00	0.04	0.04

5.65	1.99	0.65	5.00	0.00	0.04	0.04
5.70	2.01	0.65	5.00	0.00	0.04	0.04
5.75	2.03	0.65	5.00	0.00	0.04	0.04
5.80	2.05	0.65	5.00	0.00	0.04	0.04
5.85	2.08	0.65	5.00	0.00	0.04	0.04
5.90	2.10	0.65	5.00	0.00	0.04	0.04
5.95	2.13	0.65	5.00	0.00	0.04	0.04
6.00	2.15	0.65	5.00	0.00	0.04	0.04
6.05	2.18	0.65	5.00	0.00	0.04	0.04
6.10	2.21	0.65	5.00	0.00	0.04	0.04
6.15	2.24	0.65	5.00	0.00	0.04	0.04
6.20	2.27	0.65	5.00	0.00	0.04	0.04
6.25	2.30	0.65	5.00	0.00	0.04	0.04
6.30	2.33	0.65	5.00	0.00	0.04	0.04
6.35	2.36	0.65	5.00	0.00	0.04	0.04
6.40	2.40	0.65	5.00	0.00	0.04	0.04
6.45	2.43	0.65	5.00	0.00	0.04	0.04
6.50	2.47	0.65	5.00	0.00	0.03	0.03
6.55	2.50	0.65	5.00	0.00	0.03	0.03
6.60	2.54	0.65	5.00	0.00	0.03	0.03
6.65	2.58	0.65	5.00	0.00	0.03	0.03
6.70	2.58	0.65	5.00	0.00	0.03	0.03
6.75	2.58	0.65	5.00	0.00	0.03	0.03
6.80	2.58	0.65	5.00	0.00	0.03	0.03
6.85	2.58	0.65	5.00	0.00	0.03	0.03
6.90	2.58	0.65	5.00	0.00	0.03	0.03
6.95	2.58	0.65	5.00	0.00	0.03	0.03
7.00	2.58	0.65	5.00	0.00	0.03	0.03
7.05	2.58	0.64	5.00	0.00	0.03	0.03
7.10	2.58	0.64	5.00	0.00	0.03	0.03
7.15	2.55	0.64	5.00	0.00	0.03	0.03
7.20	2.51	0.64	5.00	0.00	0.03	0.03
7.25	2.48	0.64	5.00	0.00	0.03	0.03
7.30	2.45	0.64	5.00	0.00	0.03	0.03
7.35	2.43	0.64	5.00	0.00	0.03	0.03
7.40	2.40	0.64	5.00	0.00	0.03	0.03
7.45	2.37	0.64	5.00	0.00	0.03	0.03
7.50	2.34	0.64	5.00	0.00	0.03	0.03
7.55	2.32	0.64	5.00	0.00	0.03	0.03
7.60	2.29	0.64	5.00	0.00	0.03	0.03
7.65	2.26	0.64	5.00	0.00	0.03	0.03
7.70	2.24	0.64	5.00	0.00	0.03	0.03
7.75	2.21	0.64	5.00	0.00	0.03	0.03
7.80	2.19	0.64	5.00	0.00	0.03	0.03
7.85	2.17	0.64	5.00	0.00	0.03	0.03
7.90	2.14	0.64	5.00	0.00	0.03	0.03
7.95	2.12	0.64	5.00	0.00	0.02	0.02
8.00	2.10	0.64	5.00	0.00	0.02	0.02
8.05	2.07	0.64	5.00	0.00	0.02	0.02
8.10	2.05	0.64	5.00	0.00	0.02	0.02
8.15	2.03	0.64	5.00	0.00	0.02	0.02
8.20	2.01	0.64	5.00	0.00	0.02	0.02
8.25	1.99	0.64	5.00	0.00	0.02	0.02
8.30	1.97	0.64	5.00	0.00	0.02	0.02
8.35	1.95	0.64	5.00	0.00	0.02	0.02
8.40	1.93	0.64	5.00	0.00	0.02	0.02
8.45	1.91	0.64	5.00	0.00	0.02	0.02
8.50	1.89	0.64	5.00	0.00	0.02	0.02
8.55	1.87	0.64	5.00	0.00	0.02	0.02
8.60	1.85	0.64	5.00	0.00	0.02	0.02
8.65	1.84	0.64	5.00	0.00	0.02	0.02
8.70	1.82	0.64	5.00	0.00	0.01	0.01
8.75	1.80	0.64	5.00	0.00	0.01	0.01
8.80	1.78	0.64	5.00	0.00	0.01	0.01
8.85	1.77	0.64	5.00	0.00	0.01	0.01
8.90	1.75	0.64	5.00	0.00	0.01	0.01
8.95	1.74	0.64	5.00	0.00	0.01	0.01
9.00	1.72	0.64	5.00	0.00	0.01	0.01
9.05	1.70	0.64	5.00	0.00	0.01	0.01
9.10	1.69	0.64	5.00	0.00	0.01	0.01
9.15	1.67	0.64	5.00	0.00	0.00	0.00
9.20	1.66	0.64	5.00	0.00	0.00	0.00
9.25	1.64	0.64	5.00	0.00	0.00	0.00
9.30	2.00	0.64	5.00	0.00	0.00	0.00
9.35	2.00	0.64	5.00	0.00	0.00	0.00
9.40	2.00	0.64	5.00	0.00	0.00	0.00
9.45	2.00	0.64	5.00	0.00	0.00	0.00
9.50	2.00	0.64	5.00	0.00	0.00	0.00
9.55	2.00	0.64	5.00	0.00	0.00	0.00
9.60	2.00	0.64	5.00	0.00	0.00	0.00
9.65	2.00	0.64	5.00	0.00	0.00	0.00
9.70	2.00	0.64	5.00	0.00	0.00	0.00
9.75	2.00	0.64	5.00	0.00	0.00	0.00
9.80	2.00	0.64	5.00	0.00	0.00	0.00
9.85	2.00	0.64	5.00	0.00	0.00	0.00
9.90	2.00	0.64	5.00	0.00	0.00	0.00
9.95	2.00	0.64	5.00	0.00	0.00	0.00
10.00	2.00	0.64	5.00	0.00	0.00	0.00
10.05	2.00	0.64	5.00	0.00	0.00	0.00
10.10	2.00	0.64	5.00	0.00	0.00	0.00

23.65	2.00	0.64	5.00	0.00	0.00	0.00
23.70	2.00	0.64	5.00	0.00	0.00	0.00
23.75	2.00	0.65	5.00	0.00	0.00	0.00
23.80	2.00	0.65	5.00	0.00	0.00	0.00
23.85	2.00	0.65	5.00	0.00	0.00	0.00
23.90	2.00	0.65	5.00	0.00	0.00	0.00
23.95	2.00	0.65	5.00	0.00	0.00	0.00
24.00	2.00	0.65	5.00	0.00	0.00	0.00
24.05	2.00	0.65	5.00	0.00	0.00	0.00
24.10	2.00	0.65	5.00	0.00	0.00	0.00
24.15	2.00	0.65	5.00	0.00	0.00	0.00
24.20	2.00	0.65	5.00	0.00	0.00	0.00
24.25	2.00	0.65	5.00	0.00	0.00	0.00
24.30	2.00	0.65	5.00	0.00	0.00	0.00
24.35	2.00	0.65	5.00	0.00	0.00	0.00
24.40	2.00	0.65	5.00	0.00	0.00	0.00
24.45	2.00	0.65	5.00	0.00	0.00	0.00
24.50	2.00	0.66	5.00	0.00	0.00	0.00
24.55	2.00	0.66	5.00	0.00	0.00	0.00
24.60	2.00	0.66	5.00	0.00	0.00	0.00
24.65	2.00	0.66	5.00	0.00	0.00	0.00
24.70	2.00	0.66	5.00	0.00	0.00	0.00
24.75	1.96	0.66	2.98	0.00	0.00	0.00
24.80	1.94	0.66	2.94	0.00	0.00	0.00
24.85	1.92	0.66	2.92	0.00	0.00	0.00
24.90	1.91	0.66	2.89	0.00	0.00	0.00
24.95	1.89	0.66	2.86	0.00	0.00	0.00
25.00	1.88	0.66	2.84	0.00	0.00	0.00
25.05	1.88	0.66	2.83	0.00	0.00	0.00
25.10	1.87	0.66	2.83	0.00	0.00	0.00
25.15	1.87	0.66	2.82	0.00	0.00	0.00
25.20	1.87	0.66	2.82	0.00	0.00	0.00
25.25	1.87	0.66	2.81	0.00	0.00	0.00
25.30	1.87	0.67	2.81	0.00	0.00	0.00
25.35	1.86	0.67	2.80	0.00	0.00	0.00
25.40	1.86	0.67	2.80	0.00	0.00	0.00
25.45	1.86	0.67	2.79	0.00	0.00	0.00
25.50	1.86	0.67	2.78	0.00	0.00	0.00
25.55	1.86	0.67	2.78	0.00	0.00	0.00
25.60	1.86	0.67	2.77	0.00	0.00	0.00
25.65	1.85	0.67	2.77	0.00	0.00	0.00
25.70	1.85	0.67	2.76	0.00	0.00	0.00
25.75	1.85	0.67	2.76	0.00	0.00	0.00
25.80	1.85	0.67	2.75	0.00	0.00	0.00
25.85	1.85	0.67	2.75	0.00	0.00	0.00
25.90	1.85	0.67	2.74	0.00	0.00	0.00
25.95	1.84	0.67	2.74	0.00	0.00	0.00
26.00	1.84	0.67	2.74	0.00	0.00	0.00
26.05	1.84	0.67	2.73	0.00	0.00	0.00
26.10	1.84	0.67	2.73	0.00	0.00	0.00
26.15	1.84	0.68	2.72	0.00	0.00	0.00
26.20	1.84	0.68	2.72	0.00	0.00	0.00
26.25	1.83	0.68	2.71	0.00	0.00	0.00
26.30	1.83	0.68	2.71	0.00	0.00	0.00
26.35	1.83	0.68	2.70	0.00	0.00	0.00
26.40	1.83	0.68	2.70	0.00	0.00	0.00
26.45	1.83	0.68	2.69	0.00	0.00	0.00
26.50	1.83	0.68	2.69	0.00	0.00	0.00
26.55	1.83	0.68	2.69	0.00	0.00	0.00
26.60	1.82	0.68	2.68	0.00	0.00	0.00
26.65	1.82	0.68	2.68	0.00	0.00	0.00
26.70	1.82	0.68	2.67	0.00	0.00	0.00
26.75	1.82	0.68	2.67	0.00	0.00	0.00
26.80	1.82	0.68	2.66	0.00	0.00	0.00
26.85	1.82	0.68	2.66	0.00	0.00	0.00
26.90	1.82	0.68	2.66	0.00	0.00	0.00
26.95	1.82	0.68	2.65	0.00	0.00	0.00
27.00	1.81	0.69	2.65	0.00	0.00	0.00
27.05	1.81	0.69	2.64	0.00	0.00	0.00
27.10	1.81	0.69	2.64	0.00	0.00	0.00
27.15	1.81	0.69	2.64	0.00	0.00	0.00
27.20	1.81	0.69	2.63	0.00	0.00	0.00
27.25	1.81	0.69	2.63	0.00	0.00	0.00
27.30	1.81	0.69	2.62	0.00	0.00	0.00
27.35	1.81	0.69	2.62	0.00	0.00	0.00
27.40	1.80	0.69	2.62	0.00	0.00	0.00
27.45	1.80	0.69	2.61	0.00	0.00	0.00
27.50	1.80	0.69	2.61	0.00	0.00	0.00
27.55	1.80	0.69	2.61	0.00	0.00	0.00
27.60	1.80	0.69	2.60	0.00	0.00	0.00
27.65	1.80	0.69	2.60	0.00	0.00	0.00
27.70	1.80	0.69	2.59	0.00	0.00	0.00
27.75	1.80	0.69	2.59	0.00	0.00	0.00
27.80	1.80	0.69	2.59	0.00	0.00	0.00
27.85	1.79	0.69	2.58	0.00	0.00	0.00
27.90	1.79	0.70	2.58	0.00	0.00	0.00
27.95	1.79	0.70	2.58	0.00	0.00	0.00
28.00	1.79	0.70	2.57	0.00	0.00	0.00
28.05	1.79	0.70	2.57	0.00	0.00	0.00
28.10	1.79	0.70	2.57	0.00	0.00	0.00

37.15	2.00	0.74	5.00	0.00	0.00	0.00
37.20	2.00	0.74	5.00	0.00	0.00	0.00
37.25	2.00	0.74	5.00	0.00	0.00	0.00
37.30	2.00	0.74	5.00	0.00	0.00	0.00
37.35	2.00	0.74	5.00	0.00	0.00	0.00
37.40	2.00	0.74	5.00	0.00	0.00	0.00
37.45	2.00	0.74	5.00	0.00	0.00	0.00
37.50	2.00	0.74	5.00	0.00	0.00	0.00
37.55	2.00	0.74	5.00	0.00	0.00	0.00
37.60	2.00	0.74	5.00	0.00	0.00	0.00
37.65	2.00	0.74	5.00	0.00	0.00	0.00
37.70	2.00	0.74	5.00	0.00	0.00	0.00
37.75	2.00	0.74	5.00	0.00	0.00	0.00
37.80	2.00	0.74	5.00	0.00	0.00	0.00
37.85	2.00	0.74	5.00	0.00	0.00	0.00
37.90	2.00	0.74	5.00	0.00	0.00	0.00
37.95	2.00	0.74	5.00	0.00	0.00	0.00
38.00	1.04	0.74	1.40	0.00	0.00	0.00
38.05	1.03	0.74	1.39	0.00	0.00	0.00
38.10	1.02	0.74	1.37	0.00	0.00	0.00
38.15	1.01	0.74	1.36	0.00	0.00	0.00
38.20	1.00	0.74	1.35	0.00	0.00	0.00
38.25	0.99	0.74	1.33	0.00	0.00	0.00
38.30	0.98	0.74	1.32	0.00	0.00	0.00
38.35	0.97	0.74	1.31	0.00	0.00	0.00
38.40	0.96	0.74	1.30	0.00	0.00	0.00
38.45	0.95	0.74	1.29	0.00	0.00	0.00
38.50	0.95	0.74	1.28	0.00	0.00	0.00
38.55	0.94	0.74	1.27	0.00	0.00	0.00
38.60	0.93	0.74	1.26	0.00	0.00	0.00
38.65	0.92	0.74	1.25	0.00	0.00	0.00
38.70	0.92	0.74	1.24	0.00	0.00	0.00
38.75	0.91	0.74	1.23	0.00	0.00	0.00
38.80	0.91	0.74	1.22	0.00	0.00	0.00
38.85	0.90	0.74	1.21	0.00	0.00	0.00
38.90	0.89	0.74	1.21	0.00	0.00	0.00
38.95	0.89	0.74	1.20	0.00	0.00	0.00
39.00	0.88	0.74	1.19	0.00	0.00	0.00
39.05	0.88	0.74	1.19	0.00	0.00	0.00
39.10	0.87	0.74	1.18	0.00	0.00	0.00
39.15	0.87	0.74	1.17	0.00	0.00	0.00
39.20	0.86	0.74	1.17	0.00	0.00	0.00
39.25	0.86	0.74	1.16	0.00	0.00	0.00
39.30	0.86	0.74	1.16	0.00	0.00	0.00
39.35	0.85	0.74	1.15	0.00	0.00	0.00
39.40	0.85	0.74	1.14	0.00	0.00	0.00
39.45	0.84	0.74	1.14	0.00	0.00	0.00
39.50	0.84	0.74	1.13	0.00	0.00	0.00
39.55	0.84	0.74	1.13	0.00	0.00	0.00
39.60	0.83	0.74	1.13	0.00	0.00	0.00
39.65	0.83	0.74	1.12	0.00	0.00	0.00
39.70	0.83	0.74	1.12	0.00	0.00	0.00
39.75	0.83	0.74	1.11	0.00	0.00	0.00
39.80	0.82	0.74	1.11	0.00	0.00	0.00
39.85	0.82	0.74	1.11	0.00	0.00	0.00
39.90	0.82	0.74	1.10	0.00	0.00	0.00
39.95	0.82	0.74	1.10	0.00	0.00	0.00
40.00	0.81	0.74	1.10	0.00	0.00	0.00
40.05	0.82	0.74	1.11	0.00	0.00	0.00
40.10	0.83	0.74	1.12	0.00	0.00	0.00
40.15	0.84	0.74	1.14	0.00	0.00	0.00
40.20	0.86	0.74	1.15	0.00	0.00	0.00
40.25	0.87	0.74	1.17	0.00	0.00	0.00
40.30	0.88	0.74	1.18	0.00	0.00	0.00
40.35	0.89	0.74	1.20	0.00	0.00	0.00
40.40	0.90	0.74	1.22	0.00	0.00	0.00
40.45	0.91	0.74	1.23	0.00	0.00	0.00
40.50	0.93	0.74	1.25	0.00	0.00	0.00
40.55	0.94	0.74	1.27	0.00	0.00	0.00
40.60	0.95	0.74	1.29	0.00	0.00	0.00
40.65	0.97	0.74	1.30	0.00	0.00	0.00
40.70	0.98	0.74	1.32	0.00	0.00	0.00
40.75	0.99	0.74	1.34	0.00	0.00	0.00
40.80	1.01	0.74	1.36	0.00	0.00	0.00
40.85	1.02	0.74	1.38	0.00	0.00	0.00
40.90	1.04	0.74	1.40	0.00	0.00	0.00
40.95	1.05	0.74	1.42	0.00	0.00	0.00
41.00	1.07	0.74	1.44	0.00	0.00	0.00
41.05	1.09	0.74	1.46	0.00	0.00	0.00
41.10	1.10	0.74	1.49	0.00	0.00	0.00
41.15	1.12	0.74	1.51	0.00	0.00	0.00
41.20	1.14	0.74	1.53	0.00	0.00	0.00
41.25	1.15	0.74	1.56	0.00	0.00	0.00
41.30	1.17	0.74	1.58	0.00	0.00	0.00
41.35	1.19	0.74	1.61	0.00	0.00	0.00
41.40	1.21	0.74	1.63	0.00	0.00	0.00
41.45	1.23	0.74	1.66	0.00	0.00	0.00
41.50	1.25	0.74	1.69	0.00	0.00	0.00
41.55	1.27	0.74	1.71	0.00	0.00	0.00
41.60	1.29	0.74	1.74	0.00	0.00	0.00

46.15	2.00	0.74	5.00	0.00	0.00	0.00
46.20	2.00	0.74	5.00	0.00	0.00	0.00
46.25	2.00	0.74	5.00	0.00	0.00	0.00
46.30	2.00	0.74	5.00	0.00	0.00	0.00
46.35	2.00	0.74	5.00	0.00	0.00	0.00
46.40	2.00	0.74	5.00	0.00	0.00	0.00
46.45	2.00	0.74	5.00	0.00	0.00	0.00
46.50	2.00	0.74	5.00	0.00	0.00	0.00
46.55	2.00	0.74	5.00	0.00	0.00	0.00
46.60	2.00	0.73	5.00	0.00	0.00	0.00
46.65	2.00	0.73	5.00	0.00	0.00	0.00
46.70	2.00	0.73	5.00	0.00	0.00	0.00
46.75	2.00	0.73	5.00	0.00	0.00	0.00
46.80	2.00	0.73	5.00	0.00	0.00	0.00
46.85	2.00	0.73	5.00	0.00	0.00	0.00
46.90	2.00	0.73	5.00	0.00	0.00	0.00
46.95	2.00	0.73	5.00	0.00	0.00	0.00
47.00	2.00	0.73	5.00	0.00	0.00	0.00
47.05	2.00	0.73	5.00	0.00	0.00	0.00
47.10	2.00	0.73	5.00	0.00	0.00	0.00
47.15	2.00	0.73	5.00	0.00	0.00	0.00
47.20	2.00	0.73	5.00	0.00	0.00	0.00
47.25	2.00	0.73	5.00	0.00	0.00	0.00
47.30	2.00	0.73	5.00	0.00	0.00	0.00
47.35	2.00	0.73	5.00	0.00	0.00	0.00
47.40	2.00	0.73	5.00	0.00	0.00	0.00
47.45	2.00	0.73	5.00	0.00	0.00	0.00
47.50	2.00	0.73	5.00	0.00	0.00	0.00
47.55	2.00	0.73	5.00	0.00	0.00	0.00
47.60	2.00	0.73	5.00	0.00	0.00	0.00
47.65	2.00	0.73	5.00	0.00	0.00	0.00
47.70	2.00	0.73	5.00	0.00	0.00	0.00
47.75	2.00	0.73	5.00	0.00	0.00	0.00
47.80	2.00	0.73	5.00	0.00	0.00	0.00
47.85	2.00	0.73	5.00	0.00	0.00	0.00
47.90	1.63	0.73	2.23	0.00	0.00	0.00
47.95	1.61	0.73	2.20	0.00	0.00	0.00
48.00	1.59	0.73	2.18	0.00	0.00	0.00
48.05	1.57	0.73	2.15	0.00	0.00	0.00
48.10	1.56	0.73	2.13	0.00	0.00	0.00
48.15	1.54	0.73	2.10	0.00	0.00	0.00
48.20	1.52	0.73	2.08	0.00	0.00	0.00
48.25	1.50	0.73	2.06	0.00	0.00	0.00
48.30	1.49	0.73	2.03	0.00	0.00	0.00
48.35	1.47	0.73	2.01	0.00	0.00	0.00
48.40	1.46	0.73	1.99	0.00	0.00	0.00
48.45	1.44	0.73	1.97	0.00	0.00	0.00
48.50	1.43	0.73	1.95	0.00	0.00	0.00
48.55	1.41	0.73	1.93	0.00	0.00	0.00
48.60	1.40	0.73	1.91	0.00	0.00	0.00
48.65	1.38	0.73	1.90	0.00	0.00	0.00
48.70	1.37	0.73	1.88	0.00	0.00	0.00
48.75	1.36	0.73	1.86	0.00	0.00	0.00
48.80	1.35	0.73	1.85	0.00	0.00	0.00
48.85	1.33	0.73	1.83	0.00	0.00	0.00
48.90	1.32	0.73	1.81	0.00	0.00	0.00
48.95	1.31	0.73	1.80	0.00	0.00	0.00
49.00	1.30	0.73	1.78	0.00	0.00	0.00
49.05	1.29	0.73	1.77	0.00	0.00	0.00
49.10	1.28	0.73	1.75	0.00	0.00	0.00
49.15	1.27	0.73	1.74	0.00	0.00	0.00
49.20	1.26	0.73	1.73	0.00	0.00	0.00
49.25	1.25	0.73	1.71	0.00	0.00	0.00
49.30	1.24	0.73	1.70	0.00	0.00	0.00
49.35	1.23	0.73	1.69	0.00	0.00	0.00
49.40	1.22	0.73	1.68	0.00	0.00	0.00
49.45	1.21	0.73	1.66	0.00	0.00	0.00
49.50	1.20	0.73	1.65	0.00	0.00	0.00
49.55	1.19	0.73	1.64	0.00	0.00	0.00
49.60	1.18	0.73	1.63	0.00	0.00	0.00
49.65	1.18	0.73	1.62	0.00	0.00	0.00
49.70	1.17	0.73	1.61	0.00	0.00	0.00
49.75	1.16	0.73	1.60	0.00	0.00	0.00
49.80	1.15	0.73	1.59	0.00	0.00	0.00
49.85	1.15	0.73	1.58	0.00	0.00	0.00
49.90	1.14	0.73	1.57	0.00	0.00	0.00
49.95	1.13	0.73	1.56	0.00	0.00	0.00
50.00	1.12	0.73	1.55	0.00	0.00	0.00

* F.S.<1, Liquefaction Potential Zone
(F.S. is limited to 5, CRR is limited to 2, CSR is limited to 2)

Units: Unit: qc, fs, Stress or Pressure = atm (1.0581tsf); Unit Weight = pcf; Depth = ft; Settlement = in.

1 atm (atmosphere) = 1 tsf (ton/ft2)
CRRm Cyclic resistance ratio from soils
CSRsf Cyclic stress ratio induced by a given earthquake (with user request factor of safety)
F.S. Factor of Safety against liquefaction, F.S.=CRRm/CSRsf
S_sat Settlement from saturated sands
S_dry Settlement from Unsaturated Sands

S_all
NoLiq

Total Settlement from Saturated and Unsaturated Sands
No-Liquefy Soils

CPT 9.sum

Appendix D

Earthwork Specifications

APPENDIX D: EARTHWORK SPECIFICATIONS

D.1 Scope of Work

The work includes all labor, supplies and construction equipment required to construct the building pads in a good, workmanlike manner, as shown on the drawings and herein specified. The major items of work covered in this section include the following:

- Site Inspection
- Authority of Geotechnical Engineer
- Site Clearing
- Excavations
- Preparation of Fill Areas
- Placement and Compaction of Fill
- Observation and Testing

D.2 Site Inspection

- The Contractor shall carefully examine the site and make all inspections necessary, in order to determine the full extent of the work required to make the completed work conform to the drawings and specifications. The Contractor shall satisfy himself as to the nature and location of the work, ground surface and the characteristics of equipment and facilities needed prior to and during prosecution of the work. The Contractor shall satisfy himself as to the character, quality, and quantity of surface and subsurface materials or obstacles to be encountered. Any inaccuracies or discrepancies between the actual field conditions and the drawings, or between the drawings and specifications must be brought to the Owner's attention in order to clarify the exact nature of the work to be performed.
- This *Geoseismic/Geotechnical Study Report* by Converse Consultants may be used as a reference to the surface and subsurface conditions on this project. The information presented in this report is intended for use in design and is subject to confirmation of the conditions encountered during construction. The exploration logs and related information depict subsurface conditions only at the particular time and location designated on the boring logs. Subsurface conditions at other locations may differ from conditions encountered at the exploration locations. In addition, the passage of time may result in a change in subsurface conditions at the exploration locations. Any review of this information shall not relieve the Contractor from performing such independent investigation and evaluation to satisfy himself as to the nature of the surface and subsurface conditions to be encountered and the procedures to be used in performing his work.

D.3 Authority of the Geotechnical Engineer

- The Geotechnical Engineer will observe the placement of compacted fill and will take sufficient tests to evaluate the uniformity and degree of compaction of filled ground.
- As the Owner's representative, the Geotechnical Engineer will (a) have the authority to cause the removal and replacement of loose, soft, disturbed and other unsatisfactory soils and uncontrolled fill; (b) have the authority to approve the preparation of native ground to receive fill material; and (c) have the authority to approve or reject soils proposed for use in building areas.
- The Civil Engineer and/or Owner will decide all questions regarding (a) the interpretation of the drawings and specifications, (b) the acceptable fulfillment of the contract on the part of the Contractor and (c) the matters of compensation.

D.4 Site Clearing

- Clearing and grubbing shall consist of the removal from building areas to be graded of all existing structures, pavements, utilities, trees and vegetation.
- Organic and inorganic materials resulting from the clearing and grubbing operations shall be hauled away from the areas to be graded.

D.5 Excavations

- Based on observations made during our field explorations, the surficial soils can be excavated with conventional earthwork equipment.

D.6 Preparation of Fill Areas

- All organic material, organic soils, incompetent alluvium, undocumented fill soils and debris should be removed from the proposed building areas.
- In order to provide a relative uniform bearing material below shallow foundations, over-excavation and re-compaction of below the foundations and slab-on-grade are recommended. We recommend a minimum 5 feet of onsite soils below the bottom of foundations should be removed, moisture-conditioned if necessary, and replaced as compacted fill. At least the six (6) inches of soil at bottom of over-excavation, cut and transition areas should be scarified and compacted. All undocumented fill should be removed and replaced with compacted fill. The excavation to remove unsuitable soils should be extended to five (5) feet beyond the building limits and appendages where space is available. All loose, soft or disturbed earth materials should be removed from the bottom of excavations

before placing structural fill. The actual depth of removal should be determined based on observations made during grading. After the required removals have been made, the exposed native earth materials shall be excavated to provide a zone of structural fill for the support of footings, slabs-on-grade, and exterior flatwork. The fill thickness under structures should not vary.

- The subgrade in all areas to receive fill shall be scarified to a minimum depth of six (6) inches, the soil moisture adjusted within three (3) percent of the optimum moisture for granular soils and at above approximately three (3) percent of the optimum moisture for fine-grained soils. and then compacted to at least 90 percent of the laboratory maximum dry density as determined by ASTM Standard D1557 test method. Scarification may be terminated on moderately hard to hard, cemented earth materials with the approval of the Geotechnical Engineer.
- Compacted fill may be placed on native soils that have been properly scarified and recompacted as discussed above.
- All areas to receive compacted fill will be observed and approved by the Geotechnical Engineer before the placement of fill.

D.7 Placement and Compaction of Fill

- Compacted fill placed for the support of footings, slabs-on-grade, exterior concrete flatwork, and driveways will be considered structural fill. Structural fill may consist of approved on-site soils or imported fill that meets the criteria indicated below.
- Fill consisting of selected on-site earth materials or imported soils approved by the Geotechnical Engineer shall be placed in layers on approved earth materials. Soils used as compacted structural fill shall have the following characteristics:
 - All fill soil particles shall not exceed three (3) inches in nominal size, and shall be free of organic matter and miscellaneous inorganic debris and inert rubble.
 - Imported fill materials shall have an Expansion Index (EI) less than 20. All imported fill should be compacted to at least 90 percent of the laboratory maximum dry density (ASTM Standard D1557) at about three (3) percent above optimum moisture for fine grained soils, and within three (3) percent of optimum for granular soils.
- Fill soils shall be evenly spread in maximum 8-inch lifts, watered or dried as necessary, mixed and compacted to at least the density specified below. The fill shall be placed and compacted on a horizontal plane, unless otherwise approved by the Geotechnical Engineer.

- All fill placed at the site shall be compacted to at least 90 percent of the laboratory maximum dry density as determined by ASTM Standard D1557 test method. The on-site soils shall be moisture conditioned within three (3) percent of the optimum moisture for granular soils and at above approximately three (3) percent of the optimum moisture for fine-grained soils. At least the upper 12 inches of subgrade soils underneath the concrete apron, pavement and parking areas should be compacted to a minimum of 95 percent relative compaction.
- Fill exceeding five (5) feet in height shall not be placed on native slopes that are steeper than 5:1 horizontal:vertical (H:V). Where native slopes are steeper than 5:1 H:V, and the height of the fill is greater than five (5) feet, the fill shall be benched into competent materials. The height and width of the benches shall be at least two (2) feet.
- Representative samples of materials being used, as compacted fill will be analyzed in the laboratory by the Geotechnical Engineer to obtain information on their physical properties. Maximum laboratory density of each soil type used in the compacted fill will be determined by the ASTM Standard D1557 compaction method.
- Fill materials shall not be placed, spread or compacted during unfavorable weather conditions. When site grading is interrupted by heavy rain, filling operations shall not resume until the Geotechnical Engineer approves the moisture and density conditions of the previously placed fill.
- It shall be the Grading Contractor's obligation to take all measures deemed necessary during grading to provide erosion control devices in order to protect slope areas and adjacent properties from storm damage and flood hazard originating on this project. It shall be the contractor's responsibility to maintain slopes in their as-graded form until all slopes are in satisfactory compliance with job specifications, all berms have been properly constructed, and all associated drainage devices meet the requirements of the Civil Engineer.

D.8 Trench Backfill

The following specifications are recommended to provide a basis for quality control during the placement of trench backfill.

- Trench excavations to receive backfill shall be free of trash, debris or other unsatisfactory materials at the time of backfill placement.
- Trench backfill shall be compacted to a minimum relative compaction of 90 percent as per ASTM Standard D1557 test method.

- Rocks larger than one (1) inch should not be placed within 12 inches of the top of the pipeline or within the upper 12 inches of pavement or structure subgrade. No more than 30 percent of the backfill volume shall be larger than 3/4-inch in largest dimension diameter, and rocks shall be well mixed with finer soil.
- The pipe design engineer should select bedding material for the pipe. Bedding materials generally should have a Sand Equivalent (SE) greater than or equal to 30, as determined by the ASTM Standard D2419 test method.
- Trench backfill shall be compacted by mechanical methods, such as sheepsfoot, vibrating or pneumatic rollers, or mechanical tampers, to achieve the density specified herein. The backfill materials shall be brought to within three (3) percent of optimum moisture content for granular soils and fine-grained soils, then placed in horizontal layers. The thickness of uncompacted layers should not exceed eight (8) inches. Each layer shall be evenly spread, moistened or dried as necessary, and then tamped or rolled until the specified density has been achieved.
- The contractor shall select the equipment and processes to be used to achieve the specified density without damage to adjacent ground and completed work.
- The field density of the compacted soil shall be measured by the ASTM Standard D1556 or ASTM Standard D2922 test methods or equivalent.
- Observation and field tests should be performed by Converse during construction to confirm that the required degree of compaction has been obtained. Where compaction is less than that specified, additional compactive effort shall be made with adjustment of the moisture content as necessary, until the specified compaction is obtained.
- It should be the responsibility of the Contractor to maintain safe conditions during cut and/or fill operations.
- Trench backfill shall not be placed, spread or rolled during unfavorable weather conditions. When the work is interrupted by heavy rain, fill operations shall not be resumed until field tests by the project's geotechnical consultant indicate that the moisture content and density of the fill are as previously specified.

D.9 Observation and Testing

- During the progress of grading, the Geotechnical Engineer will provide observation of the fill placement operations.
- Field density tests will be made during grading to provide an opinion on the degree of compaction being obtained by the contractor. Where compaction of less than

specified herein is indicated, additional compactive effort with adjustment of the moisture content shall be made as necessary, until the required degree of compaction is obtained.

- A sufficient number of field density tests will be performed to provide an opinion to the degree of compaction achieved. In general, density tests will be performed on each one-foot lift of fill, but not less than one for each 500 cubic yards of fill placed.



State of California • Natural Resources Agency

Department of Conservation

California Geological Survey

801 K Street • MS 12-31

Sacramento, CA 95814

(916) 324-7324 • FAX (916) 445-3334

Edmund G. Brown Jr., *Governor*

John G. Parrish, Ph.D., *State Geologist*

Mr. Gary Nellesen
Director of Facilities
Mt. San Antonio College District
1100 North Grand Avenue,
Walnut, CA 91789

March 26, 2018

**Subject: Engineering Geology and Seismology Review for
Mt. San Antonio Community College – Lot R Tennis and Parking Structure
1100 North Grand Avenue, Walnut, CA 91789
CGS Application No. 03-CGS3298**

Dear Mr. Nellesen:

In accordance with your request and transmittal of documents received on February 8, 2018, the California Geological Survey has reviewed the engineering geology and seismology aspects of the consulting report prepared for Mt. San Antonio Community College. It is our understanding that this project involves the construction of a multi-story parking and tennis court structure. This review was performed in accordance with Title 24, California Code of Regulations, 2016 California Building Code (CBC) and followed CGS Note 48 guidelines. We reviewed the following report:

Geotechnical Study Report, Proposed Lot R Tennis and Parking Structure, Mt. San Antonio College, Walnut, California: Converse Consultants, 717 South Myrtle Avenue, Monrovia, CA 91016; Converse Project No. 17-31-247-, report dated December 1, 2017, 43 pages, 11 tables, 12 drawings, 4 appendices.

Based on our review, the consultants provide a thorough assessment of engineering and geologic hazard issues with respect to the proposed improvements. The principal concerns identified by the consultants are the potential for strong ground shaking, and differential settlement across the sedimentary bedrock to alluvium cut/fill boundary that bisects the proposed structure. The consultants recommend site-specific spectral acceleration parameters of $S_{Ds} = 1.446g$ and $S_{D1} = 0.784g$, which are considered reasonable.

March 26, 2018

In conclusion, *the engineering geology and seismology issues at this site are adequately assessed in the referenced report*. If you have any further questions about this review letter, please contact the reviewer.

Respectfully submitted,



Gordon G. Seitz
Engineering Geologist,
PG 5514, CEG 1718
Gordon.Seitz@conservation.ca.gov



Concur:

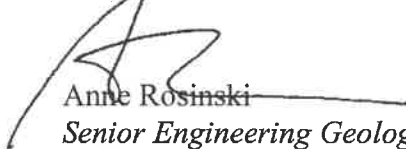

Anne Rosinski
Senior Engineering Geologist
PG 7481, CEG 2353



Enclosures:

Note 48 Checklist Review Comments

Keyed to: *Note 48 - Checklist for the Review of Engineering Geology and Seismology Reports for California Public Schools, Hospitals, and Essential Services Buildings*

Copies to:

Mark B. Schluter, *Certified Engineering Geologist* and Siva K. Sivathanan, *Registered Geotechnical Engineer*
Converse Consultants, 717 South Myrtle Avenue, Monrovia, CA 91016

Kenneth Salyer, *Architect*
HMC Architects, 3546 Concourse Street, Ontario, CA 91764

Ted Beckwith, *Senior Structural Engineer*
Division of State Architect, 700 North Alameda Street, Suite 5-500, Los Angeles, CA 90012

Note 48 Checklist Review Comments

In the numbered paragraphs below, this review is keyed to the paragraph numbers of California Geological Survey Note 48 (October, 2013 edition), *Checklist for the Review of Engineering Geology and Seismology Reports for California Public Schools, Hospitals, and Essential Services Buildings*.

Project Location

1. Site Location Map, Street Address, County Name: Adequately addressed. The consultants provide a figure with the site plotted on a 7½-minute USGS quadrangle base-map.
2. Plot Plan with Exploration Data with Building Footprint Adequately addressed. The consultants provide a plot plan with identifying markers such as streets, buildings, and property lines.
3. Site Coordinates: Adequately addressed. Latitude and Longitude provided in report: 34.0455°N, 117.8383°W

Engineering Geology/Site Characterization

4. Regional Geology and Regional Fault Maps: Adequately addressed. The consultants provide an illustration with the site plotted.
5. Geologic Map of Site: Adequately addressed. The consultants provide a detailed geologic map with proper symbols and geologic legend.
6. Subsurface Geology: Adequately addressed. The site in the area of the proposed structure was characterized by 11 hollow stem boring ranging up to 80 ft. in depth, and 17 CPT soundings ranging up to 75 ft. in depth. Previous grading at the site has resulted in the proposed building footprint area consisting of cut and fill areas. The majority of the proposed structure area, the northeastern portion consists of formational sedimentary bedrock with some fill materials stored on the surface. The western and southern areas that are a parking lot are fill areas, ranging up to 10 ft. of fill overlying alluvial soils to depths of up to 45 ft., with groundwater observed at a depth of approximately 20 ft.
7. Geologic Cross Sections: Adequately addressed.
8. Active Faulting & Coseismic Deformation Across Site: Adequately addressed. The consultants report the site is not located in an earthquake fault zone.
9. Geologic Hazard Zones (Liquefaction & Landslides): Adequately addressed. The consultants provide figures showing the project site in relation to the official CGS hazard zones. The site is not located in an earthquake-induced landslide zone, however, the western and southern portions are located in a liquefaction zone.
10. Geotechnical Testing of Representative Samples: Adequately addressed.
11. Geological Consideration of Grading Plans and Foundation Plans: Adequately addressed. The proposed structure is underlain by very dense formational bedrock on the east, and more settlement-prone alluvium on the south and west portions. To mitigate differential settlement across this boundary the consultants recommend over-excavation and re-compaction, and the use of a geofabric reinforcement. Additionally, the consultants address the possibility that temporary shoring and tie-back may be required for the cut areas where retaining walls are planned.

Seismology & Calculation of Earthquake Ground Motion

12. Evaluation of Historic Seismicity: Marginally Adequate. The consultants provide a table No. 1 “Summary of Regional Faults” that lists the San Andreas Fault 1857 earthquake as a M7.4, when the consensus magnitude is M7.9.
13. Classify the Geologic Subgrade (Site Class): Marginally Adequate. The consultants used a Vs30 of 390m/s for calculating the ground motions at the site, which matches the site observations. However, they erroneously reported a site class D, even though the site conditions result in a site class C.
14. General Procedure Seismic Parameters: Adequately addressed. The consultants report the following parameters derived from a map-based analysis:
 $S_S = 2.185g$ and $S_1 = 0.780g$
 $S_{DS} = 1.457g$ and $S_{D1} = 0.676g$
15. Seismic Design Category: Adequately addressed. The consultants report a seismic design category E.
16. Site-Specific Ground Motion Analysis: Adequately addressed. The consultants' deterministic and probabilistic MCE spectra appear reasonable based on comparison with results from the State-Wide Model (from Petersen and others, 2008). The consultants report their site-specific seismic design parameters are: $S_{DS} = 1.446g$ and $S_{D1} = 0.784g$. The site-specific ground motion analysis presented appears to be reasonable and in accordance with ASCE 7-10
17. Deaggregated Seismic Source Parameters: Adequately addressed.
18. Time-Histories of Earthquake Ground Motion: Not applicable.

Liquefaction/Seismic Settlement Analysis

19. Geologic Setting for Occurrence of Seismically Induced Liquefaction: Adequately addressed. The consultants characterize the subsurface soil conditions with CPT boring 9, and hollow stem auger borings 4, 6, and 11. They used groundwater levels of 22 ft, which appear reasonable. Encountered water levels were deeper. The data appear to support the consultants' conclusion that liquefaction of some layers may occur with some associated ground settlement.
20. Seismic Settlement Calculations: Adequately addressed. The consultants provide a liquefaction analysis, that indicates a **total seismic settlement of up to 2.6 inches, and differential settlements up to 1.3 inches** combining saturated and unsaturated soils. The liquefaction modeling indicates the potentially liquefiable layers occur at depths below 22 ft. The data appear to support the consultants' conclusion that liquefaction of some layers may occur with some associated ground settlement.
21. Other Liquefaction Effects: Not applicable.
22. Mitigation Options for Liquefaction: Not applicable.

Slope Stability Analysis

23. Geologic Setting for Occurrence of Landslides: Adequately addressed. The consultants report that the absence of significant ground slopes results in the very low potential for landslides to impact the proposed development. This assessment appears reasonable.
24. Determination of Static and Dynamic Strength Parameters: Not applicable.
25. Determination of Pseudo-Static Coefficient (K_{eq}): Not applicable.
26. Identify Critical Slip Surfaces for Static and Dynamic Analyses: Not applicable.
27. Dynamic Site Conditions: Not applicable.
28. Mitigation Options/Other Slope Failure: Not applicable.

Other Geologic Hazards or Adverse Site Conditions

29. Expansive Soils: Adequately addressed. The consultants report the near surface soils are low to moderately expansive. However, they also indicate that highly expansive soils may be excavated and their use as near surface fill should be avoided.
30. Corrosive/Reactive Geochemistry of the Geologic Subgrade: Adequately addressed.
31. Conditional Geologic Assessment: Selected geologic hazards addressed by the consultants are listed below:
 - C. Flooding: Adequately addressed. The consultants report the site is located in a FEMA zone D, areas in which flood hazards are undetermined, but possible. Furthermore, the consultants conclude that due to the absence of shallow groundwater, distance to bodies of water, and regional flood control structures, the potential for flooding at the site is considered remote.

Report Documentation

32. Geology, Seismology, and Geotechnical References: Adequately addressed.
33. Certified Engineering Geologist: Adequately addressed.
Mark B. Schluter, Certified Engineering Geologist #1415
34. Registered Geotechnical Engineer: Adequately addressed.
Siva K. Sivathasan, Registered Geotechnical Engineer #2708

Natural History Museum
of Los Angeles County
900 Exposition Boulevard
Los Angeles, CA 90007

tel 213.763.DINO
www.nhm.org

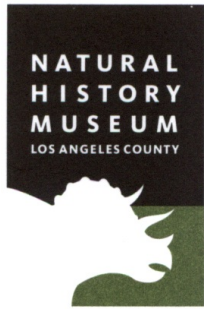

Vertebrate Paleontology Section
Telephone: (213) 763-3325

e-mail: smcleod@nhm.org

5 April 2018

Psomas
3 Hutton Centre Drive, Suite 200
Santa Ana, CA 92707-8794

Attn: Charles Cisneros, Senior Archaeologist / Project Manager

re: Paleontological Resources for the proposed Temple Avenue Project, Psomas Project
3MTS010200, in the City of Walnut, Los Angeles County, project area

Dear Charles:

I have conducted a thorough search of our Vertebrate Paleontology records for the proposed Temple Avenue Project, Psomas Project 3MTS010200, in the City of Walnut, Los Angeles County, project area as outlined on the portion of the San Dimas USGS topographic quadrangle map that you sent to me via e-mail on 22 March 2018. We have no vertebrate fossil localities that lie directly within the boundaries of the proposed project area, but we do have localities somewhat nearby from sedimentary deposits similar to those that may occur at depth in the proposed project area.

In the lower lying terrain in the southwestern portion and the eastern margin of the proposed project area the surface deposits consist of younger Quaternary Alluvium, derived as alluvial fan deposits from the San Jose Hills immediately to the north. These deposits typically do not contain significant vertebrate fossils, at least in the uppermost layers, but they may be underlain by older sedimentary deposits that do contain significant fossil vertebrate remains. Our closest vertebrate fossil locality from similar older Quaternary deposits is LACM 8014, east-southeast of the proposed project area in the northeastern Puente Hills just southwest of the intersection of the Riverside Freeway (Highway 60) and the Corona Freeway (Highway 71), that produced a fossil specimen of bison, *Bison*. A little farther to the east-southeast from the proposed project area, in English Canyon west of Chino, our older Quaternary locality LACM 1728 produced fossil specimens of horse, *Equus*, and camel, *Camelops*, at a depth of 15 to 20 feet below the surface.

In the surrounding elevated terrain there are exposures of the marine late Miocene Puente Formation, also sometimes considered to be part of the Monterey Formation in this area with the youngest member of the Puente Formation referred to as the Sycamore Canyon Formation. Our closest vertebrate fossil locality from the Puente Formation is LACM 6171, due west of the proposed project area in the hills on the west side of Collegewood Drive, that produced a fossil fish specimen of herring, *Ganolytes*. Our next closest fossil vertebrate locality from the Puente Formation is LACM 7153, just south of east of the proposed project area south of Temple Avenue and west of Valley Boulevard, that produced many specimens of fossil pipefish including the holotype (name bearing specimen of a species new to science) of the pipefish *Syngnathus emeritus*, published by R. A. Fritzsche in 1980 (Revision of the eastern Pacific Syngnathidae (Pisces: Syngnathiformes), including both Recent and fossil forms. Proceedings of the California Academy of Sciences, 42(6):181-227). Further to the southeast of the proposed project area, in Diamond Bar south and west of the intersection of the Pomona Freeway (Highway 60) and the Orange Freeway (Highway 57), our Puente Formation locality LACM 7190 produced a fauna of fossil fish including deep sea smelts, Bathylagidae, lantern fish, Myctophidae, jacks, Carangidae, and herrings, *Ganolytes* and *Etringus*.

Shallow excavations in the younger Quaternary Alluvium exposed throughout the proposed project area probably will not uncover significant vertebrate fossil remains. Deeper excavations there that extend down into older deposits, however, may well encounter significant fossil vertebrate specimens. Any substantial excavations in the proposed project area, therefore, should be monitored closely to quickly and professionally recover any fossil remains discovered while not impeding development. Sediment samples should also be collected and processed to determine the small fossil potential in the proposed project area. Any fossils recovered during mitigation should be deposited in an accredited and permanent scientific institution for the benefit of current and future generations.

This records search covers only the vertebrate paleontology records of the Natural History Museum of Los Angeles County. It is not intended to be a thorough paleontological survey of the proposed project area covering other institutional records, a literature survey, or any potential on-site survey.

Sincerely,

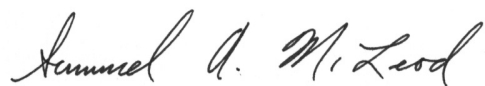

Samuel A. McLeod, Ph.D.
Vertebrate Paleontology

enclosure: invoice